



## Compact Catalogue





A black and white photograph showing a close-up of several hands working on a small, cylindrical metal component. The hands are positioned around the component, with one hand holding it steady while others appear to be adjusting or inspecting it. The background is blurred, showing what looks like a person's face and some text on a wall, possibly a name tag or a sign. The overall tone is professional and focused on craftsmanship.

*"We work together for a purpose.  
There's nothing that can't be done better  
today than yesterday."*

*Erminio Bonatti*



<b>BARI</b> Metal Work Service S.r.l. Via S. Magno km 0,400 (zona industriale) 70033 Corato BA Tel. 080 898 73 94 r.a. info.ba@metalworkservice.com www.metalworkservice.com	<b>Basilicata, Calabria, Molise, Puglia, Sicilia</b>	<b>LECCO</b> Metal Work Service S.r.l. Via per Dolzago, 39 23848 Oggiono LC Tel. 0341 26 67 11 info.lc@metalworkservice.com www.metalworkservice.com	<b>Como, Lecco, Sondrio</b>	<b>PRATO</b> Metal Work Service S.r.l. Via O. Vannucchi, 17/10 59100 Prato PO Tel. 0574 757298 info.po@metalworkservice.com www.metalworkservice.com	<b>Toscana, Umbria</b>
<b>BERGAMO</b> Metal Work Service S.r.l. Via Vienna, 28 Loc. Verdellino Zingonia 24040 Verdellino BG Tel. 035 88 53 79 info.bg@metalworkservice.com www.metalworkservice.com	<b>Bergamo</b>	<b>FILIALE DI VARESE</b> Via Gasparoli, 197 21012 Cassano Magnago VA Tel. 0331 28 09 20 info.va@metalworkservice.com www.metalworkservice.com	<b>Varese</b>	<b>RIMINI</b> Metal Work Service S.r.l. Via Piane, 23/A 47853 Coriano RN Tel. 0541 65 87 15 info.rn@metalworkservice.com www.metalworkservice.com	<b>Ascoli Piceno, Cesena, Fermo, Forlì, Pesaro, Rimini, Urbino</b>  <b>Abruzzo</b>
<b>BERGAMO</b> Metal Work Service S.r.l. Via Vienna, 28 Loc. Verdellino Zingonia 24040 Verdellino BG Tel. 035 88 53 79 info.bg@metalworkservice.com www.metalworkservice.com	<b>Bergamo</b>	<b>MANTOVA</b> Metal Work Service S.r.l. Viale d/Libertà, 9 46051 San Giorgio Bigarello MN Tel. 0376 37 41 81 info.mn@metalworkservice.com www.metalworkservice.com	<b>Mantova</b>	<b>TORINO</b> Metal Work Service S.r.l. Via Bruino, 22/2 10040 Rivalta di Torino TO Tel. 011 90 32 666 metalwto@metalworkservice.com www.metalworkservice.com	<b>Alessandria, Asti, Cuneo, Torino</b>  <b>Liguria, Sardegna, Valle d'Aosta</b>
<b>BOLOGNA</b> Metal Work Service S.r.l. Via del Fresatore, 7 40138 Bologna BO Tel. 051 70 27 11 info.bo@metalworkservice.com www.metalworkservice.com	<b>Bologna, Ferrara, Ravenna</b>	<b>MODENA</b> Metal Work Service S.r.l. Via S. Giovanni Bosco, 267 41122 Modena MO Tel. 059 23 98 06 info.mo@metalworkservice.com www.metalworkservice.com	<b>Modena</b>	<b>TREVISO</b> Metal Work Service S.r.l. Via P. A. Gemelli, 34/d 31038 Postioma di Paese TV Tel. 0422 48 45 78 r.a. info.tv@metalworkservice.com www.metalworkservice.com	<b>Belluno, Treviso, Venezia</b>  <b>Friuli Venezia Giulia</b>
<b>BRESCIA</b> Metal Work Service S.r.l. Via del Mella, 37 - Z.I. Fornaci 25131 Brescia BS Tel. 030 35 855 r.a. info.bs@metalworkservice.com www.metalworkservice.com	<b>Brescia</b>	<b>MONZA BRIANZA</b> Metal Work Service S.r.l. Via Altiero Spinelli, 57 20862 Arcore MB Tel. 039 61 80 056 info.mi@metalworkservice.com www.metalworkservice.com	<b>Lodi, Milano, Monza-Brianza</b>	<b>VERONA</b> Metal Work Service S.r.l. Via Evangelista Torricelli, 71/a 37136 Verona VR Tel. 045 50 31 23 info.vr@metalworkservice.com www.metalworkservice.com	<b>Verona</b>
<b>CREMONA</b> Metal Work Service S.r.l. Via Sesto, 62 26100 Cremona CR Tel. 0372 27 64 8 info.cr@metalworkservice.com www.metalworkservice.com	<b>Cremona, Piacenza</b>	<b>NOVARA</b> Metal Work Service S.r.l. Piazzale A. Antonelli, 8 28060 S. Pietro Mosezzo Fr. Nibbia NO Tel. 0321 43 79 86 info.no@metalworkservice.com www.metalworkservice.com	<b>Biella, Novara, Pavia, Verbano-Cusio, Vercelli</b>	<b>VICENZA</b> Metal Work Service S.r.l. Via Progresso, 70 36035 Marano Vicentino VI Tel. 0445 56 05 90 info.vi@metalworkservice.com www.metalworkservice.com	<b>Padova, Rovigo, Vicenza</b>
		<b>PARMA</b> Metal Work Service S.r.l. P.za Lunardi 27/A 43100 Parma PR Tel. 0521 24 09 64 info.pr@metalworkservice.com www.metalworkservice.com	<b>Parma, Reggio Emilia</b>		



## Authorized Dealers

### North

#### **PADOVA**

ATI Compressori S.r.l.  
Via Padre Nicolini, 23  
35013 Cittadella PD  
Tel. 049 9401777  
Fax. 049 9400665  
info@aticompressori.it  
www.aticompressori.it

Padova

#### **TRENTINO ALTO ADIGE**

E.B.I. Group S.p.a.  
Via Maccani, 197  
38100 Trento TN  
Tel. 0461 82 55 75  
info@ebigroup.it  
www.ebigroup.it

Trentino  
Alto Adige

### Centre

#### **FROSINONE**

R.C.A. S.r.l.  
Via le lame, 20  
03100 Frosinone FR  
Tel. 0775 29 23 17  
info@rcafrosinone.it  
www.rcafrosinone.it

Frosinone

#### **LATINA**

Atilsystem S.r.l.  
Via Pantanaccio, 76  
04100 Latina LT  
Tel. 0773 48 80 08  
info@atilsystem.com  
www.atilsystem.com

Latina,  
Rieti,  
Roma,  
Viterbo

#### **MACERATA**

Torresi Raffaele & C S.r.l.  
Via Sandro Pertini, 51  
62012 Civitanova Marche MC  
Tel. 0733 80 11 20  
info@torresiraffaele.it  
www.torresiraffaele.it

Ancona,  
Macerata

### South and Islands

#### **AVELLINO**

A.R.A. S.a.s.  
di C. Argenziano & C.  
Via Appia, 123/125  
83042 Atripalda AV  
Tel. 0825 62 56 03  
info@araforiture.it  
www.araforiture.it

Avellino,  
Benevento

#### **CAGLIARI**

G. Carlo Lai  
Via Ranieri Sampante, 6  
09121 Cagliari CA  
Tel. 070 280235  
lai.gianc@gmail.com

Sardegna

#### **NAPOLI**

Oleodinamica e Pneumatica  
Ardolino S.r.l.  
Via M.le Manfredi, 24  
80039 Saviano NA  
Tel. 081 82 11 468  
oleodi15@oleodinamicadiardolino.191.it

Napoli  
(provincia)

#### **R.C.P. Service S.r.l.**

Via Nuova delle brecce, 176  
80147 Napoli NA  
Tel. 081 75 24 238  
info@rcpcasale.com  
www.rcpcasale.com

Caserta,  
Napoli (città),  
Salerno

## Subsidiaries



### Europe

#### BELGIUM

**Metal Work België/Belgique**  
Mechelsesteenweg 277  
B-1800 Vilvoorde - Belgium  
Tel. 0032 02 75 16 120  
metalwork@metalworkpneumatic.be  
www.metalworkpneumatic.be

#### CZECH REPUBLIC

**Metal Work Pneumatic CZ, s.r.o.**  
Ostravská 494  
73925 Sviadnov  
Czech Republic  
Tel. 00420 596 748 577  
info@metalwork.cz  
www.metalwork.cz

#### DENMARK

**Metal Work Danmark A/S**  
Korskildelund 1  
2670 Greve - Denmark  
Tel. 0045 70 22 23 11  
metalwork@metalwork.dk  
www.metalwork.dk

#### FINLAND

**Metal Work Finland OY**  
Puurtajankatu 15A  
04440 Järvenpää - Finland  
Tel. 00358 10 836 5700  
metalwork@metalwork.fi  
www.metalwork.fi

#### FRANCE

**Metal Work France Sarl**  
Parc d'Activités  
de l'Esplanade - BP 222  
14 Rue Enrico Fermi  
77463 Saint Thibault  
des Vignes Cedex - France  
Tel. 0033 01 60 94 00 00  
info@metalwork.fr  
www.metalwork.fr

#### GERMANY

**Metal Work Deutschland GmbH**  
**GERMAN OFFICE**  
Rankinstraße 2  
D-86899 Landsberg am Lech  
Germany  
Tel. 0049 08191 42894-0  
metalwork@metalwork.de  
www.metalwork.de  
**AUSTRIAN OFFICE**  
Tel. 0043 720 010100  
metalwork@metalwork.at

#### HOLLAND

**Metal Work Nederland B.V.**  
Postbus 90 - 6710 BB EDE  
Voltastraat 9 - 6716 AJ EDE  
Holland  
Tel. 0031 0318 66 51 11  
metalwork@metalwork.nl  
www.metalwork.nl

#### POLAND

**Metal Work Polska Sp. z o.o.**  
ul. Szamotulska 1, Baranowo  
62-081 - Przemierowo  
Poland  
Tel. 0048 61 65 01 840  
metalwork@metalwork.pl  
www.metalwork.pl

#### PORTUGAL

**Metal Work Portugal Lda**  
Estrada Nacional, 1  
P.C. Emiauto Pav-D Sobreiro  
Torio 3850 - Albergaria  
a Velha - Portugal  
Tel. 00351 23 45 25 425  
www.metalwork.eu

#### ROMANIA

**Metal Work Pneumatic S.r.l.**  
Jud. Timiș Sat Moșnița Nouă  
com. Moșnița Nouă,  
307285, Str. Copenhaga, 1  
Romania  
Tel. 0040 374 62 22 60  
Fax 0040 374 09 15 47  
metalwork@metalworkpneumatic.ro  
www.metalworkpneumatic.ro

#### RUSSIA

**OOO Metal Work Pneumatic**  
121354, Moscow,  
Dorogobuzhskaya str., 14 build.  
6 - Russia  
Tel. 007 499 558 10 40  
007 499 995 12 19  
info@metalworkpneumatic.ru  
www.metalworkpneumatic.ru

#### SPAIN

**Metal Work Iberica S.A.**  
Pol. Ind. Can Magí  
c/Can Magí, 9  
08210 Barbera del Valles  
(Barcelona) - Spain  
Tel. 0034 937 180 244  
metalwork@metalwork.es  
www.metalwork.es

#### SWEDEN

**Metal Work Sverige AB**  
Modemgatan, 7  
235 39 Vellinge - Sweden  
Tel. 0046 040 42 07 00  
metalwork@metalwork.se  
www.metalwork.se

#### SWITZERLAND

**Metal Work Pneumatik GmbH**  
Langfeldstrasse 88  
8500 Frauenfeld - Switzerland  
Tel. 0041 052 369 40 40  
metalwork@metalwork.ch  
www.metalwork.ch

#### UK

**Metal Work UK Ltd**  
Blackhill drive  
Wolverton Mill  
Milton Keynes - MK 12 5TS  
UK  
Tel. 0044 01908 22 22 88  
sales@metalwork.co.uk  
www.metalwork.co.uk

#### UKRAINE

**Metal Work Ukraine TOV**  
54-B, Chornovola str.,  
Sofiivska Borschagivka  
Kiev region, 08131- Ukraine  
Tel. 00380 44 502 95 71  
metalwork@metalwork.ua  
www.metalwork.ua

## Africa

#### SOUTH AFRICA

**Metal Work Pneumatic South Africa (Pty) Ltd**  
Unit 15, Heron Park - 80  
Corobrick Road Riverhorse Valley  
(East) - Durban - KwaZulu Natal -  
4017 - South Africa  
Tel. 0027 (0) 64 9004900  
metalwork@metalworkpneumatic.co.za  
www.metalworkpneumatic.co.za

## Americas

#### BRAZIL

**Metal Work Pneumatica do Brasil Ltda**  
Rua Otacilio Jacinto Homem,  
415 CEP 93120-590  
São Leopoldo - RS - Brazil  
Tel. 0055 51 3590 7100  
metalwork@metalwork.com.br  
www.metalwork.com.br

#### USA

**Metal Work Pneumatic USA, Inc.**  
1120 Eden Road, Suite 106  
Arlington, TX 76001 - USA  
Tel. 001 817 701 4000  
metalwork@metalwork.org  
www.metalwork.org

## Asia/ Oceania

#### AUSTRALIA

**Metal Work Pneumatic AUSTRALIA Pty Limited**  
P.O. Box 4209  
Dandenong South VIC 3164  
93-97 Remington Drive  
Dandenong South VIC 3175  
Australia  
Tel. 0061 03 97 06 67 18  
vicsales@metalwork.com.au  
www.metalwork.com.au

#### CHINA

**Metal Work Pneumatic Components (Shanghai) Co., Ltd.**  
Building 15, No.198,  
Chang Jian Road,  
200949 - Bao Shan District,  
Shanghai - China  
Tel. 0086 21 36043088  
info@metalworkchina.cn  
www.metalworkchina.cn

#### INDIA

**Metal Work Pneumatic India Private Limited**  
No. 18-20, 1St Cross,  
Bilekahalli Industrial Area  
Adj. IIMB Compound, - India  
Bannerghatta Road  
Bangalore - 560 076  
Tel. 0091 80 26480076  
sales@metalwork.in  
www.metalwork.in

#### INDONESIA

**PT. Metal Work Pneumatic (INDONESIA)**  
The Icon Horizon Broadway  
M2 No.5  
15345 Bumi Serpong  
Damai, Tangerang - Indonesia  
Tel. 0062 21 30303862  
info@metalwork.id  
www.metalwork.id

#### MALAYSIA

**Metal Work Pneumatic (M) SDN BHD**  
11 Jalan Anggerik Mokara  
31/52 Seksyen  
31, Kota Kemuning  
40460 Shah Alam  
Selangor Darul Ehsan  
Malaysia  
Tel. 0060 03 5131 3838  
metalwork@metalworkmal.com  
www.metalwork.eu

#### THAILAND

**Metal Work Pneumatic (Thailand) Co. Ltd**  
55/289 Moo.3, 345 Road,  
Lumpo, Bangbuathong,  
Nonthaburi 11110  
Thailand  
Tel. 00662 961 7000  
metalwork@metalwork.co.th  
www.metalwork.co.th

## Authorized Dealers

### Europe

#### BULGARIA

**Ka Matic Ltd.**  
9N Kuklensko shose  
4004 Plovdiv - Bulgaria  
Tel. 00359 32 677 772  
info@kamatic.com  
www.kamatic.com

#### CYPRUS

**Andrew Chr. - Demetriades Ltd.**  
Corner Atiakos Nemeseos ST  
Pollouriotissa  
1620 Nicosia - Cyprus  
Tel. 00357 22 43 14 50  
a.c.demetriades@cablenet.com.cy

#### GREECE

**Airblock Ltd**  
P.O. Box 1284  
Industrial Zone Bl 56B  
57022 - Sindos - Greece  
Tel. 0030 23 10 72 25 55  
info@airblock.gr  
www.airblock.gr

#### Unitair Ltd

20, Sp. Patsi Str.  
10447 - Votanikos  
El-099013125 Athens  
Greece  
Tel. 0030 21 03 41 65 62  
supplies@unitair.gr  
www.unitair.gr

#### HUNGARY

**ENTRA-SYS Kft.**  
Fonógyári út 2.  
H-6728, Szeged - Hungary  
Tel. 0036 62 468 478  
entra-sys@entra-sys.hu  
www.entra-sys.hu

#### IRELAND

**Pneumatics Ltd**  
Old Naas Road - Bluebell  
Dublin 12 - Ireland  
Tel. 0035 31 45 68 111  
sales@flomax.ie  
www.flomax.ie

#### NORWAY

**Servi AS**  
P.O. Box 3230  
1402 Ski - Norway  
Tel. 0047 64 97 97 97  
post@pmcsemi.no  
www.servi.no

#### REPUBLIC OF MACEDONIA

**Devit Compressor and Pneumatic Systems**  
24/13 Ul. Razlovecko  
Vostanie MK - 1000 Skopje  
Republic of Macedonia  
Tel. 00389 2 3091 660  
devit@devit.com.mk  
www.devit.com.mk

#### SERBIA

**Shift d.o.o.**  
Mileševska 52/5  
11000 Beograd - Serbia  
Tel. 00381 11 3961 195  
shift@shift.rs - office@shift.rs  
www.shift.rs

#### SLOVENIA AND CROATIA

**Tio Pnevmatika d.o.o.**  
Alpska cesta 43  
4248 Lesce - Slovenia  
Tel. 00386 4 537 09 20  
info@tio-pnevmatika.si  
www.tio-pnevmatika.si

#### TURKEY

**HPA Teknoloji Geliştirme Ltd.Şti.**  
10040 Sokak No: 4  
Yeni Parseller İ.A.O.S.B Çiğli İzmir  
Turkey  
Tel. 0090 232 328 19 21  
info@hpa.com.tr  
www.hpa.com.tr

### Africa

#### EGYPT

**Hydrotech S.A.E**  
25 Taha Hussen Rd.  
New Nozha (Cairo) - Egypt  
Tel. 0020 26 200 414  
info@hydrotechegypt.com  
www.hydrotechegypt.com

#### MOROCCO

**Sofimed S.a.r.l.**  
137, Boulevard Moulay Ismail  
20290 Casablanca - Morocco  
Tel. 00212 (0) 522 240 101  
contacts@sofimedmaroc.com  
www.sofimedmaroc.com

#### TUNISIA

**Tecprau S.a.r.l.**  
21 Street Jerissa,  
Megrine Riadh 2033  
Ben Arous - Tunisia  
Tel. 0021 63 14 02 447  
mariem@tecprau.com  
www.tecprau.com

### Americas

#### ECUADOR

**Ecuatoriana Industrial Termoval Cia Ltda**  
Concepción E5-37 y  
Valparaiso Quito - Ecuador  
Tel. 00593 22 95 28 88  
info@ecuatorianaindustrial.com  
www.ecuatorianaindustrial.com

#### URUGUAY

**Fidemar S.A.**  
Minas 1634 - CP 11200  
Montevideo - Uruguay  
Tel. 00598 2 40 21 717  
info@fidemar.com.uy  
www.fidemar.com.uy

### Asia/ Oceania

#### IRAN

**Era Feat Sanaat Qeshm Trading Co**  
Flat 3 - Building 1  
Southern Iranshahr Ave.  
P.O. BOX 17445-4  
Tehran - Iran  
Tel. 00982 1 88140957-9  
info@erafeatco.com  
www.erafeatco.com

#### ISRAEL

**R.e.p. Automation Ltd**  
Haamelim St, 2  
2611002 - HAIFA BAY  
Israel  
Tel. 00972 48403012  
rep@repac.co.il  
www.repac.co.il

#### KINGDOM OF SAUDI ARABIA

**Bariq Al Emdadat Trading Establishment**  
Rasa Bin Ali Street (Behind Mutanabi Street)  
Post Box: 27001  
11653 Malaz - Riyadh  
Kingdom of Saudi Arabia  
Tel. 009661 4728782  
info@bariqarabia.com  
www.bariqarabia.com

#### OMAN

**Muscat Pneumatic System & Project Llc**  
P.o.box 105 Pc 120  
Muscat Sultanate of Oman  
Oman  
Tel. 0096 82 44 37 144  
sales@muscat-pneumatic.com

#### SOUTH KOREA

**Seowon Corporation**  
1001 Ilsan Technotown  
1141-1 Beksuk-Dong  
Ilsandong-Gu, Goyang City  
Gyeonggi-Do 410-722  
South Korea  
Tel. 0082 31 90 61 100  
mail@seowoncorp.com  
www.seowoncorp.com

#### TAIWAN

**Century Automatiom Corporation**  
5F8, no.1 Wu-Chuan  
1 St.Road Hsin  
Taipei Hsien - Taiwan  
Tel. 00886 22 29 88 436  
century@cenauto.com.tw

#### UNITED ARAB EMIRATES

**ACME Industrial Hardware Trading L.L.C.**  
Shop 8,9, Al Zarooni Building,  
Bury Street Deira,  
P.O. BOX 3636 - Dubai  
United Arab Emirates  
Tel. 00971 422 38 897  
pneumatics@acme-world.com  
www.acme-world.com





<b>ACTUATORS</b>	● CYLINDERS	PAGE	8	<b>ACTUATORS</b>
	● GRIPPERS	PAGE	34	
	● ROTARY ACTUATORS	PAGE	36	
	● SLIDES	PAGE	38	
	● V-LOCK	PAGE	40	
	● HYDRAULIC-PNEUMATIC (HYDRAULIC BRAKE)	PAGE	49	
	● ELECTRIC CYLINDER	PAGE	51	
	● SENSORS, POSITION SENSOR, T-SLOT ACCESSORIES	PAGE	79	
<b>VALVES</b>	● VALVES	PAGE	86	<b>VALVES</b>
	● COILS AND CONNECTORS	PAGE	122	
	● VALVES ISLANDS	PAGE	124	
	● SLAVES FIELDBUS	PAGE	157	
	● MULTIPLE-FLUID PROCESS VALVES	PAGE	159	
<b>UNITS</b>	● SYNTESI	PAGE	166	<b>UNITS</b>
	● BIT	PAGE	175	
	● SKILLAIR	PAGE	182	
	● NEW DEAL	PAGE	195	
	● ONE	PAGE	204	
	● PRECISION REGULATION AND PRESSURE CONTROL	PAGE	208	
<b>FITTINGS</b>	● AUTOMATIC FITTINGS	PAGE	211	<b>FITTINGS</b>
	● AUTOMATIC FITTINGS FOR USE IN THE FOOD INDUSTRY	PAGE	219	
	● FITTING SERIES A - B - C - D	PAGE	221	
	● TAPARED THREAD FITTINGS WITH PTFE	PAGE	225	
	● STAINLESS STEEL FITTINGS	PAGE	226	
<b>ACCESSORIES</b>	● LINE ON LINE	PAGE	228	<b>ACCESSORIES</b>
	● COUPLINGS	PAGE	234	
	● FLOW REGULATOR	PAGE	235	
	● AUXILIARY VALVES	PAGE	239	
	● VARIOUS ACCESSORIES	PAGE	242	
	● STAINLESS STEEL ACCESSORIES	PAGE	246	

## ISO 6432 MINI-CYLINDERS



### ISO 6432 MINI-CYLINDERS SERIES STD

TECHNICAL DATA		Polyurethane	NBR		FKM/FPM		Low temperature
Max operating pressure	bar MPa		10				
Temperature range	°C	-10 to +80	-10 to +80		-10 to +150 (non-magnetic cylinders)		-35 to +80
Fluid		Unlubricated air. Lubrication, if used, must be continuous					
Bores	mm	8; 10; 12; 16; 20; 25					
Design		Chamfered stainless steel barrel					
Standard strokes †	mm	Single-acting:	for bores Ø 8 to 25 strokes from 1 to 50				
		Double-acting:	for bores Ø 8 to 10 strokes from 1 to 100				
			for bores Ø 12 to 16 strokes from 1 to 200				
			for bores Ø 20 to 25 strokes from 1 to 500				
		Double-acting, cushioned:	for bores Ø 16 strokes from 1 to 300				
			for bores Ø 20 to 25 strokes from 1 to 500				
Versions		Double-acting, Double-acting cushioned, Single-acting extended or retracted rod, Through-rod, Through-rod cushioned, Version with piston rod block, No stick-slip					
Magnet for sensors		All versions come complete with magnet. Supplied without magnet on request.					
Inrush pressure		Ø 8	Ø 10	Ø 12	Ø 16	Ø 20	Ø 25
single piston rod	bar	0.8	0.8	0.8	0.6	0.6	0.6
through-rod	bar	1	1	1	0.8	0.8	0.8
Notes		<p>For speeds lower than 0.2 m/s to prevent surging, use the version No stick-slip and non-lubricated air.</p> <p>† Maximum recommended strokes. Higher values can create operating problems</p>					

#### KEY TO CODES

CYL	1 1 2 TYPE	0	16 BORE	0020 STROKE	C MATERIAL	P GASKETS	► E		
	101 SE axial coupling	0 Standard	▼ 08	For the maximum applicable strokes, look at the technical data	A C45 chrome rod, aluminium piston	P Polyurethane	E Single-acting extended rod		
	102 DEM axial coupling	U Bronze rear head bushing	▼ 10		C C45 chrome rod, technopolymer piston	N NBR			
	104 SE through-rod	V Without head nut	▼ 12			Z Stainless steel piston rod and nut aluminium piston		● V FKM/FPM	
■ ◀	106 SE cushioned	S Non-magnetic	16					X Stainless steel piston rod and nut technopolymer piston	● B Low temperature
■	109 DEA	▲ G No stick-slip	20						
	110 DE		25						
◀	111 SE								
	112 DEM								
■	113 DEMA								
* ▼	114 DEM through-rod								
* ▼ ■	115 DEMA through-rod								
◆	116 DEM for mechanical lock								
■	117 DEMA for mechanical lock								

DE: Double-acting (non-cushioned, not magnetic)  
 DEM: Magnetic double-acting (non-cushioned)  
 DEMA: Magnetic double-acting (cushioned)  
 DEA: Cushioned double-acting (non-magnetic)  
 SE: Single-acting (magnetic)

● Only available for non-magnetic versions (S) and with aluminium piston (A or Z)  
 ▲ For speeds lower than 0.2 m/s, to prevent surging. Use no-lubricated air only  
 ▼ Stainless steel piston rod  
 ■ Available from Ø 16  
 ◆ Available from Ø 12  
 \* For ø16 to 25 aluminium piston, stainless steel piston rod  
 ◀ 106... single-acting retracted rod, cushioned  
 106...E single-acting extended rod, cushioned available in Ø 16 - Ø 20 - Ø 25  
 111... single-acting retracting piston rod  
 111...E single-acting extended piston rod, available in Ø 16 - Ø 20 - Ø 25  
 ► Letter to be added only to the single acting extended rod version



## ISO 6432 MINI-CYLINDERS SERIES TP - TECHNOPOLYMER HEADS

TECHNICAL DATA		POLYURETHANE		
Max operating pressure	bar	10		
	MPa	1		
Temperature range	°C	-10 to +60		
Fluid		Unlubricated air. Lubrication, if used, must be continuous		
Bores	mm	16; 20; 25		
Design		Aluminium liner chamfered on the heads		
Standard strokes <b>+</b>	mm	Ø 16: from 1 to 200		
	mm	Ø 20 to 25: from 1 to 500		
Versions		Double-acting, Double Through-rod (for both there are magnetic and non magnetic versions)		
Inrush pressure	bar	Ø 16	Ø 20	Ø 25
single piston rod	bar	0.6	0.6	0.6
through-rod	bar	0.8	0.8	0.8
Notes		The standard version is lacking of the head nut. <b>Use of fittings with a taper thread is NOT recommended.</b> <b>+</b> Maximum recommended strokes. Higher values can create operating problems.		

### KEY TO CODES

CYL	1 1 0 TYPE	3	16 BORE	0	020 STROKE	C MATERIAL	P GASKETS
	110 DE non-magnetic minicylinder	● 3 TP heads (standard)	■ 16	0 Standard	For the maximum suppliable strokes, look at the technical data	C C45 chrome rod	P Polyurethane
	112 DEM minicylinder	● 4 TP heads (standard) + head nut	■ 20	S Non-magnetic		X Stainless rod	
	114 DEM through-rod minicylinder		■ 25				

DE: Double-acting (non-cushioned, not magnetic).

DEM: Double action magnetic (unless otherwise specified) not cushioned.

As standard the cylinders are already No stick-slip version.

● This version don't provide the nut on the head.

■ Ø 16 will be only in version with stainless rod (X).

## ACCESSORIES

### FOOT MODEL A



Code	Ø	Description
W0950080001	8/10	Acc. foot Mod. A
W0950120001	12/16	Acc. foot Mod. A
W0950200001	20/25	Acc. foot Mod. A

### NUT FOR PISTON RODS MODEL DA



Code	Ø	Description
0950080011	8/10	Acc. nut for piston rod Mod. DA M4
0950120011	12/16	Acc. nut for piston rod Mod. DA M6
0950200011	20	Acc. nut for piston rod Mod. DA M8
0950322010	25	Acc. nut for piston rod Mod. DA M10x1.25

### H PROFILE: FOR HIGH LOAD



Code
W0700__2__*

### FLANGE MODEL C



Code	Ø	Description
W0950080002	8/10	Acc. flange Mod. C
W0950120002	12/16	Acc. flange Mod. C
W0950200002	20/25	Acc. flange Mod. C

### FORK MODEL GK-M



Code	Ø	Description
W0950080020	8/10	Acc. fork Mod. GK-M M4
W0950120020	12/16	Acc. fork Mod. GK-M M6
W0950200020	20	Acc. fork Mod. GK-M M8
W0950322020	25	Acc. fork Mod. GK-M M10x1.25

### H PROFILE: FOR HIGH SPEEDS



Code
W0700__3__*

### COUNTER-HINGE MODEL BC



Code	Ø	Description
W0950080005	8/10	Acc. counter-hinge Mod. BC
W0950120005	12/16	Acc. counter-hinge Mod. BC
W0950200005	20/25	Acc. counter-hinge Mod. BC

### ROD EYE MODEL GA-M



Code	Ø	Description
W0950080025	8/10	Acc. rod eye Mod. GA-M M4
W0950120025	12/16	Acc. rod eye Mod. GA-M M6
W0950200025	20	Acc. rod eye Mod. GA-M M8
W0950322025	25	Acc. rod eye Mod. GA-M M10x1.25

### U PROFILE: FOR LIMITED LOADS AND SPEEDS



Code
W0700__1__*

### NUT FOR HEADS MODEL D



Code	Ø	Description
0950080010	8/10	Acc. nut for heads Mod. D M12x1.25
0950120010	12/16	Acc. nut for heads Mod. D M16x1.5
0950200010	20/25	Acc. nut for heads Mod. D M22x1.25

### MECHANICAL PISTON ROD LOCK FOR ISO 6432 MINI-CYLINDERS



Code	Ø	Description
W5010001099	12/16	Acc. piston rod MV70 LD
W5010001100	20	Acc. piston rod MV70 LD
W5010001101	25	Acc. piston rod MV70 LD

\* CODE EXAMPLE TO ORDER  
W0700**252100**

STANDARD STROKE  
50 - 100 - 150 - 200 - 250 - 320 - 400 - 500

## ISO 15552 CYLINDERS

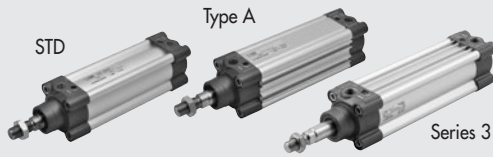

TECHNICAL DATA		Polyurethane	NBR	FKM/FPM	Low temperature
Max operating pressure	bar			10	
	MPa			1	
	psi			145	
Temperature range	°C	-25 to +80	-10 to +80	[-10 to +150 (non-magnetic cyl.)]	
Fluid		Unlubricated air. Lubrication, if used, must be continuous			
Bore	mm	32; 40; 50; 63; 80; 100; 125			
Design		Heads with tap type screws			
Standard stroke †	mm	Single-acting: for bores 32 to 63 strokes from 1 to 250 Double-acting: for bores 32 to 80 strokes from 1 to 2800 for bores 100 to 125 strokes from 1 to 2600			
Versions		Double-acting cushioned, Single-acting extended or retracted piston rod cushioned, Through-rod cushioned, Long cushioning, High-temperature, Piston rod lock, Oil seal, Through-rod oil seal, Low friction, No stick-slip.			
Sensor magnet		All versions come complete with magnet. Supplied without magnet on request.			
Inrush pressure		Ø 32; 40: 0.4 bar Ø 50; 63 strokes < 1500 mm: 0.3 bar; strokes > 1500 mm: 0.4 bar Ø 80; 100; 125 strokes < 1500 mm: 0.2 bar; strokes > 1500 mm: 0.4 bar			
Notes		<b>For speeds lower than 0.2 m/s to prevent surging, use the version No stick-slip and non-lubricated air.</b> † Maximum recommended strokes. Higher values can create operating problems			

## ISO 15552 CYLINDERS SERIES STD

### KEY TO CODES SERIES STD

CYL	1 2 1 TYPE	0	3 2 BORE	0 0 5 0 STROKE	C MATERIAL	P GASKETS	▼ E
	120 Double-acting, cushioned, non-magnetic	0 Diameter	32	For the maximum	A C45 chromed rod, aluminium piston rod: standard for all cylinders with ≥ 1000 mm-stroke cylinders and for cylinder with Ø 80 mm and over	N NBR gaskets	E Single-acting
	121 Double-acting, cushioned	S Non-magnetic	40	suppliable		P Polyurethane gaskets	extended rod
	122 Through-rod	▲ G No stick-slip	50	strokes,		V FKM/FPM gaskets	
●	124 Double-acting, non-cushioned		63	look at the	C C45 chromed rod, technopolymer piston: standard for cylinders of Ø 32 to 63 mm with < 1000 mm strokes	● B Low temperature	
	125 Opposed		80	technical	Z Stainless steel piston rod and nut aluminium piston	** C COMBI	
+	126 Single-acting		100	data	X Stainless steel piston rod and nut technopolymer piston		
	127 Tandem		125				
*	136 Rod lock version						
* ♦	137 Version with piston rod lock						
	Piston rod lock + guide unit						

- In the code of cylinder with letter in fourth position Ø 100 becomes A1; Ø 125 becomes A2
- Only available for versions with aluminium piston (A or Z)
- + Available until Ø 63 and only the versions with piston in aluminum (A or Z)  
126... Single-acting retracted rod  
126...E Single-acting extended rod
- ▼ Letter to be added only to the single acting extended rod version

- ▲ For speeds lower than 0.2 m/s, to prevent surging. Use no-lubricated air only
- ♦ Available up to Ø 100
- \* Not available for gaskets V or B
- \*\* Not available for long cushion version [131]

Available low-friction version [123] and long-cushioning version [131]

## ISO 15552 CYLINDERS TYPE A

### KEY TO CODES TYPE A

CYL	1 2 1 TYPE	A	3 2 BORE	0 0 5 0 STROKE	C MATERIAL	P GASKETS	▼ E
	121 Double-acting, cushioned	A Standard	32	For the maximum applicable strokes, look at the technical data	A C45 chromed rod, aluminium piston rod: standard for all cylinders with $\geq 1000$ mm-stroke cylinders and for cylinder with $\varnothing 80$ mm and over	N NBR gaskets P Polyurethane gaskets V FKM/FPM gaskets	E Single-acting extended rod
●	122 Through-rod	▲ B No stick-slip	40				
	124 Double-acting, non-cushioned	C Non-magnetic	50				
	125 Opposed		63				
+	126 Single-acting		80				
	127 Tandem		A1 = $\varnothing 100$ A2 = $\varnothing 125$				
	134 Rod lock version						
*	136 Version with piston rod lock						
* ♦	137 Piston rod lock + guide unit						
					C C45 chromed rod, technopolymer piston: standard for cylinders of $\varnothing 32$ to $63$ mm with $<1000$ mm strokes	● B Low temperature ** C COMBI	
				Z Stainless steel piston rod and nut aluminium piston			
				X Stainless steel piston rod and nut technopolymer piston			

- Only available for versions with aluminium piston (A or Z)
- + Available until  $\varnothing 63$  and only the versions with piston in aluminium (A or Z)
- 126... Single-acting retracted rod
- 126...E Single-acting extended rod
- ▼ Letter to be added only to the single acting extended rod version

- ▲ For speeds lower than  $0.2$  m/s, to prevent surging. Use no-lubricated air only
- ♦ Available up to  $\varnothing 100$
- \* Not available for gaskets V or B
- \*\* Not available for long cushion version [131]

Available low-friction version [129] and long-cushioning version [130]

## ISO 15552 CYLINDERS SERIES 3

### KEY TO CODES SERIES 3

CYL	1 2 1 TYPE	3	3 2 BORE	0 0 5 0 STROKE	C MATERIAL	P GASKETS	▼ E
	121 Double-acting, cushioned	3 Series 3	32	For the maximum applicable strokes, look at the technical data	A C45 chromed rod, aluminium piston rod: standard for all cylinders with $\geq 1000$ mm-stroke cylinders and for cylinder with $\varnothing 80$ mm and over	N NBR gaskets P Polyurethane gaskets V FKM/FPM gaskets	E Single-acting extended rod
●	122 Through-rod	◆ 4 Series 3	40				
	124 Double-acting, non-cushioned	5 Series 3	50				
	125 Opposed	Non-magnetic	63				
+	126 Single-acting		80				
	127 Tandem		A1 = $\varnothing 100$ A2 = $\varnothing 125$				
■	134 Rod lock version						
■ *	136 Version with piston rod lock						
■ * *	137 Piston rod lock + guide unit						
					C C45 chromed rod, technopolymer piston: standard for cylinders of $\varnothing 32$ to $63$ mm with $<1000$ mm strokes	● B Low temperature C COMBI	
				Z Stainless steel piston rod and nut aluminium piston			
				X Stainless steel piston rod and nut technopolymer piston			

- Only available for versions with aluminium piston (A or Z)
- + Available until  $\varnothing 63$  and only the versions with piston in aluminium (A or Z)
- 126... Single-acting retracted rod
- 126...E Single-acting extended rod

- ▼ Letter to be added only to the single acting extended rod version
- ◆ For speeds lower than  $0.2$  m/s, to prevent surging. Use no-lubricated air only
- \* Available until  $\varnothing 100$
- Not available for gasket V or B

### KEY TO CODES ULTRA-LOW FRICTION SERIES 3

CYL	1 2 3 TYPE	3	3 2 BORE	0 1 0 0 STROKE	A MATERIAL	N GASKETS
	123 Ultra-low friction	3 Double-acting magnetic	32	From 1 to 1200 mm	A C45 chromed rod, aluminium piston rod	N NBR gaskets
		5 Double-acting not magnetic	40			
			50			
			63			
			80			
			A1 = $\varnothing 100$ A2 = $\varnothing 125$			
				Z Stainless steel piston rod and nut aluminium piston		

ALL the cylinders are No stick-slip.  
ALL the cylinders are non-cushioned.

Ultra-low friction cylinders are not available in the through-rod version.

## ISO 15552 TWO-FLAT CYLINDERS



TECHNICAL DATA		POLYURETHANE			
Max operating pressure	bar	10			
	MPa	1			
	psi	145			
Temperature range	°C	-25 to +80			
Fluid		Unlubricated air. Lubrication, if used, must be continuous			
Bore	mm	32; 40; 50; 63			
Design		Heads with Tap Tite screws			
Maximum stroke	mm	Ø 32 = 300	Ø 40 = 400	Ø 50 = 500	Ø 63 = 500
Versions		Double-acting cushioned, Through-rod cushioned, No stick-slip			
Sensor magnet		All versions come complete with magnet. Supplied without magnet on request.			
Inrush pressure	bar	Ø 32 = 0.4	Ø 40 = 0.4	Ø 50 = 0.3	Ø 63 = 0.3
Max torque on piston rod	Nm	Ø 32 = 0.2	Ø 40 = 0.4	Ø 50 = 1	Ø 63 = 1
Maximum rotation on the rod	degrees	Ø 32 = 1° 30'	Ø 40 = 1° 30'	Ø 50 = 1°	Ø 63 = 1°
Notes		<b>For speeds lower than 0.2 m/s to prevent surging, use the version No stick-slip and non-lubricated air.</b>			

### KEY TO CODES FOR ISO 15552 TWO-FLAT STD CYLINDERS

CYL	1 2 1 TYPE	0	3 2 BORE	0 0 5 0 STROKE	F MATERIAL	P GASKETS
	120 Double-acting, cushioned, non-magnetic	0 Diameter	32 50	+ Ø 32 stroke 1 to 300 mm	F "Two-Flat" piston rod	P Polyurethane gaskets
	121 Double-acting, cushioned	S Non-magnetic	40 63	+ Ø 40 stroke 1 to 400 mm	AISI 303, stainless steel	
●	122 Through-rod	▲ G No stick-slip		+ Ø 50 to 63 stroke 1 to 500 mm	nut, technopolymer piston	

### KEY TO CODES FOR ISO 15552 TWO-FLAT TYPE A CYLINDERS

CYL	1 2 1 TYPE	A	3 2 BORE	0 0 5 0 STROKE	F MATERIAL	P GASKETS
●	121 Double-acting, cushioned	A Standard	32 50	+ Ø 32 stroke 1 to 300 mm	F "Two-Flat" piston rod	P Polyurethane gaskets
●	122 Through-rod	▲ B No stick-slip	40 63	+ Ø 40 stroke 1 to 400 mm	AISI 303, stainless steel	
		C Non-magnetic		+ Ø 50 to 63 stroke 1 to 500 mm	nut, technopolymer piston	

### KEY TO CODES FOR ISO 15552 TWO-FLAT SERIE 3 CYLINDERS

CYL	1 2 1 TYPE	3	3 2 BORE	0 0 5 0 STROKE	F MATERIAL	P GASKETS
	121 Double-acting, cushioned	3 Series 3	32 50	+ Ø 32 stroke 1 to 300 mm	F "Two-Flat" piston rod	P Polyurethane gaskets
●	122 Through-rod	▲ 4 Series 3 No stick-slip	40 63	+ Ø 40 stroke 1 to 400 mm	AISI 303, stainless steel	
		5 Series 3 Non-magnetic		+ Ø 50 to 63 stroke 1 to 500 mm	nut, technopolymer piston	

+ Maximum recommended strokes. Higher values can create operating problems

● Supplied with aluminium piston

▲ For speeds lower than 0.2 m/s, to prevent surging. Use no-lubricated air only

## TWIN-ROD CYLINDER SERIES TWNC



TECHNICAL DATA		POLYURETHANE			
Max operating pressure	bar	10			
	MPa	1			
	psi	145			
Temperature range	°C	-10 to +80			
Fluid		Filtered, unlubricated air. Lubrication, if used, must be continuous.			
Bores	mm	32; 40; 50; 63; 80; 100			
Strokes +	mm	from 25 to 500			
Design		Extruded profile			
Esecution		Magnetic standard cushioned			
Forces generated at 6 bar thrust/retraction	N	Ø 32: 434/350		Ø 63: 1683/1471	
		Ø 40: 678/597		Ø 80: 2714/2295	
		Ø 50: 1060/940		Ø 100: 4241/3812	
Notes		+ Maximum recommended strokes. Higher values can create operating problems			

### KEY TO CODES

CYL	W 1 4 0 TYPE	0 3 2 BORES	0 0 2 5 STROKE	+ Maximum recommended strokes. Higher values can create operating problems.
	W140 Double-acting cylinder, magnetic, cushioned	032 063	+ 0025 to 0500 mm	
	W142 Double-acting cylinder, magnetic, cushioned single through-rod	040 080		
		050 100		

ACCESSORIES - SEE ISO 15552 CYLINDERS STD PAGE 14

## ISO 15552 CYLINDER WITH END-OF-STROKE STOP



TECHNICAL DATA		Polyurethane	NBR		FKM/FPM	Low Temperature
Max operating pressure	bar				10	
	MPa				1	
	psi				145	
Temperature range	°C	-25 to + 80	-10 to + 80		-10 to + 150	-35 to + 80
Fluid		Unlubricated air. Lubrication, if used, must be continuous				
Design		Heads with Top Tite screws				
Standard stroke $\ddagger$	mm	for bores $\varnothing$ 32 to 63 strokes from 30 to 2800 for bores $\varnothing$ 80 to 100 strokes from 35 to 2600				
Versions		Double-acting cushioned, Through-rod cushioned, No stick-slip.				
Sensor magnet		YES				
Bore	mm	$\varnothing$ 32	$\varnothing$ 40	$\varnothing$ 50	$\varnothing$ 63	$\varnothing$ 80 $\varnothing$ 100
Static retention force	N	500	500	2000	2000	5000 5000
Maximum axial clearance in the lock position	mm	1.5	1.5	1.5	1.5	1.5 1.5
Minimum release pressure	bar	$\geq 2.5$	$\geq 2.5$	$\geq 2.5$	$\geq 2.5$	$\geq 2$ $\geq 2$
Maximum locking pressure	bar	$\leq 0.5$				
Forces generated at 6 bar thrust/retraction		See cylinder "General technical data" at the beginning of the chapter				
Weights						
Only one stop, with piston rod extended or retracted, stroke = 0	g	573	860	1367	1793	3515 5197
Stops either with piston rod extended or retracted, stroke = 0	g	713	1060	1647	2143	4215 6497
Every mm of stroke, cylinder with piston rod cylinder	g	2.20	2.15	4.57	5.03	7.49 8.79
Every mm of stroke, through-rod cylinder	g	3.09	4.73	7.04	7.44	10.16 12.33
Notes		<p>For speeds lower than 0.2 m/s to prevent surging, use the version No stick-slip and non-lubricated air.</p> <p><math>\ddagger</math> Maximum recommended strokes. Higher values can create operating problems</p>				

### KEY TO CODES

CYL	1 2 1	3	3 2	0 0 5 0	C	P	F1
	TYPE		BORE	STROKE	MATERIAL	GASKETS	END-OF-STROKE STOP
	<b>121</b> Double-acting cushioned <b>122</b> Through-rod <b>124</b> Double-acting, non-cushioned	<b>3</b> Series 3 <b>4</b> Series 3 No stick-slip <b>5</b> Series 3 Non-magnetic	<b>▲ 32</b> = $\varnothing$ 32 <b>40</b> = $\varnothing$ 40 <b>50</b> = $\varnothing$ 50 <b>63</b> = $\varnothing$ 63 <b>80</b> = $\varnothing$ 80 <b>A1</b> = $\varnothing$ 100	For the maximum applicable strokes, look at the technical data	<b>A</b> C45 chromed rod, aluminium piston rod: standard for all cylinders with $\geq 1000$ mm-stroke cylinders and for cylinder with $\varnothing$ 80 mm and over <b>C</b> C45 chromed rod, technopolymer piston: standard for cylinders of $\varnothing$ 32 to 63 mm with <1000 mm strokes <b>Z</b> Stainless steel piston rod and nut aluminium piston <b>X</b> Stainless steel piston rod and nut technopolymer piston	<b>N</b> NBR gaskets <b>P</b> Polyurethane gaskets <b>V</b> FKM/FPM gaskets <b>● B</b> Low temperature	<b>F1</b> Extended piston rod <b>F2</b> Retracting piston rod <b>F3</b> Retracting piston rod and extended piston rod

- Only available for versions with aluminium piston (A or Z)
- ◆ For speeds lower than 0.2 m/s, to prevent surging. Use no-lubricated air only

- ▲ Regarding the  $\varnothing$  32 cylinders, the heads with end-of-stroke stop hasn't the pneumatic cushioning

### ACCESSORIES

All the accessories of ISO 15552 cylinders can be used, except for the guide units (GDS, GDH, GDM) since the protrusion of the locking piston interferes with the guide unit.

**NB:** The screws used to secure the accessory to the heads fitted with a stop must be longer than those supplied together with the accessories. The screw length is calculated by summing up the catalogue-specified thickness of the accessory flange and the BG1 dimension, rounding down to -3 mm.

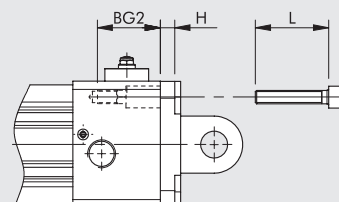

$$L = BG2 + H - (0 - 3) \text{ mm}$$

## ACCESSORIES EXAMPLE: 0950322007

### FOOT - MODEL A



Code	Description
W095_2001	
W095_3001	For twin-rod

### FEMALE HINGE MODEL B



Code
W095_2003

### MALE HINGE MODEL BA



Code
W095_2004

### ARTICULATED MALE HINGE MODEL BAS



Code
W095_2006

### CETOP HINGE FOR MODEL B - MODEL GL



Code
W095_2008

### COUNTER HINGE FOR MODEL B - MODEL GS



Code
W095_2108

### ISO 15552 HINGE FOR MODEL B - MODEL AB7



Code
W095_2017

### FRONT-REAR FLANGE MODEL C



Code	Description
W095_2002	
W095_3002	For twin-rod (front)

### ROD NUT - MODEL S



Code	Ø	Description
0950322010	32	Acc. rod nut cyl. 15552 M10x1.25
0950402010	40	Acc. rod nut cyl. 15552 M12x1.25
0950502010	50/63	Acc. rod nut cyl. 15552 M16x1.5
0950802010	80/100	Acc. rod nut cyl. 15552 M20x1.5
0951252010	125	Acc. rod nut cyl. 15552 M27x2

### ROD EYE - MODEL GA-M



Code	Ø	Description
W0950322025	32	Acc. rod eye Mod. GA-M.M10x1.25
W0950402025	40	Acc. rod eye Mod. GA-M.M12x1.25
W0950502025	50/63	Acc. rod eye Mod. GA-M.M16x1.5
W0950802025	80/100	Acc. rod eye Mod. GA-M.M20x1.5
W0951252025	125	Acc. rod eye Mod. GA-M.M27x2

### FORK - MODEL GK-M



Code	Ø	Description
W0950322020	32	Acc. fork Mod. GK-M.M10x1.25
W0950402020	40	Acc. fork Mod. GK-M.M12x1.25
W0950502020	50/63	Acc. fork Mod. GK-M.M16x1.5
W0950802020	80/100	Acc. fork Mod. GK-M.M20x1.5
W0951252020	125	Acc. fork Mod. GK-M.M27x2

### SELF ALIGNING ROD COUPLER MODEL GA-K



Code	Ø	Description
W0950322030	032	Acc. self aligning rod coupler Mod. GA-K-M10x1.25
W0950402030	040	Acc. self aligning rod coupler Mod. GA-K-M12x1.25
W0950502030	050/063	Acc. self aligning rod coupler Mod. GA-K-M16x1.5
W0950802030	080/100	Acc. self aligning rod coupler Mod. GA-K-M20x1.5

### INTERMEDIATE HINGE MODEL EN, FOR STD, STD TWO-FLAT SERIES AND TWIN-ROD



Code
095_2007

### INTERMEDIATE HINGE MODEL EN, FOR TYPE A AND TYPE A TWO-FLAT SERIES



Code
095_2107

### COUNTER-HINGE FOR MODEL EN - MODEL EL

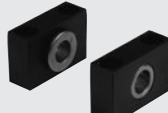

Code	Ø	Description
W0950322009	032	Acc. counter-hinge Mod. EL
W0950402009	040/050	Acc. counter-hinge Mod. EL
W0950632009	063/080	Acc. counter-hinge Mod. EL
W0951002009	100/125	Acc. counter-hinge Mod. EL

### GDS: M PROFILE FOR LIMITED LOADS AND SPEEDS



Code
W070_1_*

### GDH: H PROFILE FOR HIGH LOADS



Code
W070_2_*

### GDM: H PROFILE FOR HIGH SPEED



Code
W070_3_*

\* CODE EXAMPLE TO ORDER  
W0700322100  
STANDARD STROKE  
50 - 100 - 150 - 200 - 250 - 320 - 400 - 500

### MECHANICAL ROD BLOCK



Code	Ø	Description
W5010001102	32	Acc. rod block MV5032/LD
W5010001103	40	Acc. rod block MV5040/LD
W5010001104	50	Acc. rod block MV5050/LD
W5010001109	63	Acc. rod block MV5063/LD
W5010001106	80	Acc. rod block MV5080/LD
W5010001107	100	Acc. rod block MV5100/LD
W5010001108	125	Acc. rod block MV5125/LD

### VALVE FIXING BRACKET - CYLINDER SERIES KCV

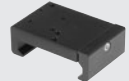

Code	Description
0950322090	Kit fix. bracket cil. 32 valve
0950402090	Kit fix. bracket cil. 40 valve
0950502090	Kit fix. bracket cil. 50 valve
0950632090	Kit fix. bracket cil. 63 valve
0950802090	Kit fix. bracket cil. 80 valve
0951002090	Kit fix. bracket cil. 100 valve
0951252090	Kit fix. bracket cil. 125 valve

### KIT FOR FIXING VALVES TO BRACKETS, FOR SERIES KCV BRACKETS

Code	Description
0950002001	Kit fix. val. ISO 1 on cyl. ISO 15552
0950002002	Kit fix. val. ISO 2 on cyl. ISO 15552
0950002003	Kit screws fix. val. M16 on cyl. ISO 15552
0950002004	Kit screws fix. val. 1/8 1/4 on cyl. ISO 15552
0950002006	Kit screws fix. val. 1/2 on cyl. ISO 15552

### POSITION SENSOR

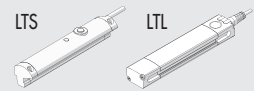

Model	For ISO 15552 cylinders
LTS	type A - series 3
LTL	type A

For technical data and usage strokes see page 84.

## CYLINDERS ISO 15552 STD, TYPE "A" AND SERIES 3: SPARE PARTS

### NEW RELEASE

Code	Bore	Description
009 ... 0101	Ø 32 to 125	Complete set of polyurethane gaskets
009 ... 0103	Ø 32 to 125	Complete set of gaskets FKM/FPM (high temperature)
009 ... 0502	Ø 32 to 125	Complete set of NBR gaskets
009 ... 1651	Ø 32 to 125	Polyurethane piston rod gasket kit
009 ... 1652	Ø 32 to 125	NBR piston rod gasket + seeger
009 ... 1653	Ø 32 to 125	FKM/FPM piston rod gasket + seeger
009 ... 0110N	Ø 32 to 125	Complete polyurethane front head kit
009 ... 0304N	Ø 32 to 125	Complete NBR front head kit
009 ... 0111N	Ø 32 to 125	Complete polyurethane rear head kit
009 ... 0305N	Ø 32 to 125	Complete NBR rear head kit
009 ... 0604	Ø 32 to 125	Complete polyurethane piston kit
009 ... 0602	Ø 32 to 125	Complete NBR piston kit
009 ... 0704N	Ø 32 to 125	Complete polyurethane head A+P+piston kit
009 ... 0702N	Ø 32 to 125	Complete NBR head A+P-piston kit
009 ... 0800	Ø 32 to 125	Magnet

### EXAMPLE: 00950320101

The OLD RELEASE version with black front heads is no longer available. For spare parts, please contact our sales offices.

## CYLINDERS ISO 15552 STD AND TYPE "A" TWO-FLAT: SPARE PARTS

### NEW RELEASE

Code	Bore	Description
009 ... 0101F	Ø 32 to 63	Set of polyurethane gaskets
009 ... 0110FN	Ø 32 to 63	Complete polyurethane front head kit
009 ... 0111N	Ø 32 to 63	Complete polyurethane rear head kit
009 ... 0604	Ø 32 to 63	Complete polyurethane piston kit
009 ... 0704FN	Ø 32 to 63	Complete polyurethane head front+rear+piston kit
009 ... 0800	Ø 32 to 63	Magnet

### EXAMPLE: 00950320101F

The OLD RELEASE version with black front heads is no longer available. For spare parts, please contact our sales offices.





## ISO 15552 CYLINDERS Ø 160-200 ROUND BARREL



TECHNICAL DATA		NBR		FKM/FPM	
Max operating pressure	bar MPa			10	
Temperature range	°C	-20 to +80		-10 to +150	
Design		Round barrel with tie rods			
Standard strokes	mm	25-50-75-80-100-125-150-200-250-300-350-400-500-600-700-800-900-1000			

### KEY TO CODES FOR ROUND BARREL

CYL	W 1 2 1 TYPE	1 6 0 DIAMETER-EXECUTION	0 0 5 0 STROKE	0 2 0 0 EXECUTION
W120	Double-acting, cushioned, non magnetic	160 160 200 200	+ 0025 to 2800 mm	Specify H1 value ONLY for version with intermediate hinge
W121	Double-acting, cushioned, non magnetic	XA3 160 stainless steel piston rod		
W122	Double-acting, cushioned, through-rod	XA4 200 stainless steel piston rod		
W123	Double-acting, cushioned, through-rod, non magnetic	VA3 160 FKM/FPM gasket, stainless steel piston rod		
W124	Double-acting, non-cushioned	VA4 200 FKM/FPM gasket, stainless steel piston rod		
		KA3 160 FKM/FPM gasket, C45 piston rod		
		KA4 200 FKM/FPM gasket, C45 piston rod		
		AA3 160 + intermediate hinge		
		AA4 200 + intermediate hinge		
		● GA3 160 No stick-slip		
		● GA4 200 No stick-slip		

+ Maximum recommended strokes. Higher values can create operating problems  
 ● For speeds lower than 0.2 m/s, to prevent surging. Use no-lubricated air only

### ACCESSORIES EXAMPLE: W0951602001

#### FOOT - MODEL A



Code  
W095\_\_2001

#### FLANGE - MODEL C (FRONT AND REAR)



Code  
W095\_\_2002

#### ROD EYE - MODEL GA-M



Code Description  
W0952002025 Acc. rod eye Mod. GA-M M36X2 160/200

#### FEMALE HINGE - MODEL B



Code  
W095\_\_2003

#### CETOP COUNTER-HINGE - MODEL GL



Code Description  
W0951602008 Acc. counter-hinge Mod. GL-160-200

#### FORK - MODEL GK-M



Code Description  
W0951602020 Acc. fork Mod. GK-M M36X2 160/200

#### MALE HINGE - MODEL BA



Code  
W095\_\_2004

#### COUNTER-HINGE MODEL EL

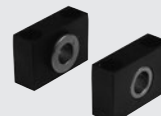

Code Description  
W0951602009 Acc. counter-hinge Mod. EL-160/200

#### ROD NUT - MODEL S



Code Description  
W0951602010 Acc. rod nut Mod. S D. M36X2 160/200

### SPARE PARTS EXAMPLE: W0951602101

Code	Bore	Description	Code	Bore	Description
W095__2101	Ø 160 - 200	Complete set of gaskets	W095__2115	Ø 160 - 200	Complete magnetic piston kit
W0951602165	Ø 160 - 200	NBR piston rod gasket kit + seeger	W095__2118	Ø 160 - 200	Complete non-magnetic piston kit
W0951602166	Ø 160 - 200	FKM/FPM piston rod gasket kit + seeger	W095__2120	Ø 160 - 200	Complete head A + P + non-magnetic piston
W095__2102	Ø 160 - 200	Complete set of gaskets FKM/FPM (high temperature)	W095__2119	Ø 160 - 200	Complete head A + P + magnetic piston
W095__0104	Ø 160 - 200	Complete front head kit	W095__2300	Ø 160 - 200	Magnet
W095__0105	Ø 160 - 200	Complete rear head kit			

## ISO 1552 CYLINDERS Ø 250-320

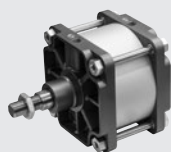

TECHNICAL DATA		NBR	FKM/FPM
Max operating pressure	bar		10
	MPa		1
	psi		145
Temperature range	°C	-20 to +80	-10 to +150
Fluid		Unlubricated air. Lubrication, if used, must be continuous.	
Bores	mm	250 and 320	
Design		Round barrel with tie rods	
Standard strokes	mm	from 1 to 2000	
Versions		Double-acting, Cushioned or non-cushioned, Single piston rod or cushioned through piston rod, High-temperature, No stick-slip	
Magnet for sensors		Versions with or without magnet	
Inrush pressure		Ø 250: 0.2 bar / Ø 320: 0.15 bar	
Notes		For speeds lower than 0.2 m/s to prevent surging, use the version No stick-slip and non-lubricated air.	

### KEY TO CODES

CIL	W 1 2 1 TYPE	2 5 0 DIAMETER-EXECUTION	0 3 0 0 STROKE	0 2 0 0 EXECUTION
	W120 Double-acting, cushioned, non magnetic	250 250 320 320	0001 to 2000 mm	Specify H1 value ONLY for version with intermediate hinge
	W121 Double-acting, cushioned	XA5 250 stainless steel piston rod and nut		
	W122 Double-acting, cushioned, through-rod	XA6 320 stainless steel piston rod and nut		
	W123 Double-acting, cushioned, through-rod, non magnetic	KA5 250 FKM/FPM gasket, C45 piston rod and nut		
	W124 Double-acting, non-cushioned	VA5 250 FKM/FPM gasket, stainless steel piston rod and nut		
		AA5 250 + intermediate hinge AA6 320 + intermediate hinge ● GA5 250 No stick-slip ● GA6 320 No stick-slip		

● For speeds lower than 0.2 m/s, to prevent surging. Use no-lubricated air only.

### ACCESSORIES EXAMPLE: W0952502003

#### FEMALE HINGE - MODEL B



Code  
W095 2003

#### ROD EYE - MODEL GA-M



Code  
W095 2025

#### ROD NUT - MODEL S



Code	Ø	Description
W0952502010	250	Acc. rod nut Mod. S M42x2
W0953202010	320	Acc. rod nut Mod. S M48x2
W095XA52011	250	Acc. Stainless steel rod nut Mod. S M42x2
W095XA62011	320	Acc. Stainless steel rod nut Mod. S M48x2

#### MALE HINGE - MODEL BA



Code  
W095 2004

#### FORK - MODEL GK-M



Code  
W095 2020

### SPARE PARTS EXAMPLE: W0952502101

Code	Bores	Type
W095 . . .2101	250÷320	Complete set of gaskets
W0952502102	250	Complete set of gaskets FKM/FPM (high temperature)
W095 . . .0104	250÷320	Complete front head kit
W095 . . .0105	250÷320	Complete rear head kit

## COMPACT CYLINDERS

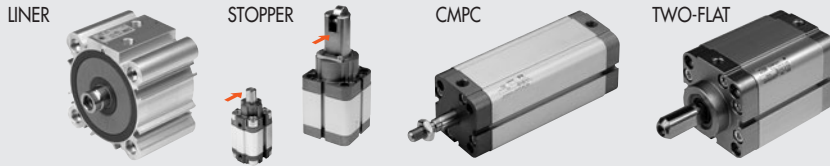

### ISO 21287 COMPACT CYLINDERS - SERIES LINER

TECHNICAL DATA		POLYURETHANE					FKM/FPM		
Max operating pressure	bar						10		
	MPa						1		
	psi						145		
Temperature range	°C	-10 to +60 (Ø 20 to 63)					-10 to +150 (non-magnetic cylinders)		
		-10 to +80 (Ø 80 to 100)							
Fluid		Unlubricated air. Lubrication, if used, must be continuous.							
Bores	mm	20; 25; 32; 40; 50; 63; 80; 100 with ISO 21287 fixing centre distances							
Design Versions		With profile							
		Double-acting, Double-acting through-rod, Single-acting extended or retracted rod, Single-acting through-rod, Double-acting through-rod perforated, Double-acting non-rotating, Double-acting through-rod non-rotating, No stick-slip							
		All versions are available with male or female piston rod.							
Magnet for sensors		All versions come complete with magnet. Supplied without magnet on request.							
Inrush pressure		Ø 20	Ø 25	Ø 32	Ø 40	Ø 50	Ø 63	Ø 80	Ø 100
for single piston rod	bar	0.6	0.6	0.6	0.4	0.4	0.4	0.4	0.4
for through-rod	bar	0.8	0.8	0.6	0.4	0.4	0.4	0.4	0.4
Notes		For correct operation, it is advisable to use 50 µm filtered air							
		<b>For speeds lower than 0.2 m/s to prevent surging, use the version No stick-slip and non-lubricated air.</b>							

#### KEY TO CODES

CYL	2 8 TYPE	0	0	20 BORE	0	0 5 0 STROKE	X MATERIAL	P GASKETS
28	Compact cylinder ISO 21287 male piston rod	0 Double-acting	0 Magnetic	20	0 Standard		* C C45 piston rod chromium-plated	P Polyurethane gaskets
		1 Double-acting through-rod	□ S Non-magnetic	25			▷ X Stainless steel piston rod and nut	▶ V FKM/FPM gaskets
		2 Double-acting through-rod perforated	▲ G No stick-slip	32			◁ A C45 chromed rod, aluminium piston	
29	Compact cylinder ISO 21287 female piston rod	● 3 Single-acting retracting piston rod		40			○ Z Stainless steel piston rod and nut aluminium piston	
		● 4 Single-acting extended piston rod		50				
		● 5 Single-acting through-rod		63				
		● 6 Single-acting through piston rod perforated		80				
		▼ 7 Double-acting non-rotating		◆ 100				
		A Double-acting through-rod non-rotating						

- Can also be used as double-acting with spring return
- ▼ For versions 29 only (female piston rod)
- ▲ For Ø 20 to 25 the standard version (0 or S)
- For Ø 20 to 100 version with gaskets in FKM / FPM (0 or S) is already "no stick slip"
- For speeds lower than 0.2 m/s, to prevent surging. Use no-lubricated air only**
- ◆ In the code of cylinder with letter in fourth position Ø 100 becomes A1
- ▶ Only for standard double acting and standard through rod double acting version (for Ø 20 and Ø 25 only "non-magnetic" version provided)

- Compulsory for Ø 20 and Ø 25 version Z
- \* Only for Ø 32 to 63 P version (Polyurethane gaskets)
- ▷ Only for Ø 20 to 63 P version (Polyurethane gaskets)
- ◁ Only for Ø 32 to 100 V version (FKM/FPM gaskets) and for Ø 80 and 100 P version (Polyurethane gaskets)
- Only for Ø 20 to 100 V version (FKM/FPM gaskets) and for Ø 80 and 100 P version (Polyurethane gaskets)

#### STROKES

Standard stroke for single-acting cylinders	Standard stroke for other types	Max. recommended strokes for other types	Max. recommended strokes for non-rotating cylinders	Max recommended strokes for through-rod perforated
Ø 20 to 100 → 1 to 25 mm	Ø 20 to 25 → 1 to 60 mm Ø 32 to 100 → 1 to 80 mm	Ø 20 to 25 → 300 mm Ø 32 to 63 → 400 mm Ø 80 to 100 → 500 mm	Ø 20 to 63 → 120 mm Ø 80 to 100 → 150 mm	Ø 20 to 40 → 1 to 80 mm Ø 50 to 63 → 1 to 100 mm Ø 80 to 100 → 1 to 160 mm

Maximum recommended strokes. Higher values can create operating problems

## COMPACT CYLINDERS SERIES CMPC

TECHNICAL DATA		POLYURETHANE					FKM/FPM				
Max operating pressure	bar						10				
	MPa						1				
Temperature range	psi						145				
	°C	-10 to +80					-10 to +150 (non-magnetic cylinders)				
Fluid		Unlubricated air. Lubrication, if used, must be continuous									
Bores	mm	Ø 12; 16; interchangeable with similar products									
	mm	Ø 32; 40; 50; 63; 80; 100 with ISO 15552 fixing centre distances									
Design Versions	mm	Ø 20; 25; 32; 40; 50; 63; 80; 100 with NFE 49-004-1 and 2 fixing centre distances									
		With profile, heads with screws									
Magnet for sensors		All versions come complete with magnet. Supplied without magnet on request.									
Inrush pressure	single piston rod	Ø 12	Ø 16	Ø 20	Ø 25	Ø 32	Ø 40	Ø 50	Ø 63	Ø 80	Ø 100
	through-rod	0.6	0.6	0.6	0.6	0.6	0.4	0.4	0.4	0.4	0.4
Notes		1	0.8	0.8	0.8	0.6	0.4	0.4	0.4	0.4	0.4
		For correct operation, it is advisable to use 50 µm filtered air									
<b>For speeds lower than 0.2 m/s to prevent surging, use the version No stick-slip and non-lubricated air.</b>											

### KEY TO CODES

CYL	2 3	1	0	2 5	0	0 5 0	X	P
	TYPE			BORE		STROKE **	MATERIAL	GASKETS
23	Compact cylinder centre distances to UNITOP male piston rod	0 Double-acting through-rod	0 Magnetic S Non-magnetic ▲ G No stick-slip	12 16 20 25 32 40 50 63 80 100	0 Standard + A 2-stage tandem + B 3-stage tandem + C 4-stage tandem		* C C45 piston rod chromium-plated ▷ X Stainless steel piston rod and nut	P Polyurethane gaskets ▶ + V FKM/FPM gaskets
24	Compact cylinder centre distances to UNITOP female piston rod	● 3 Single-acting retracting piston rod		◆ 100	<b>MULTI-POSITION</b> ●● P Stage 1 ●● R Stage 2 ●● T Stage 3		◁ A C45 chromed rod, aluminium piston ○ Z Stainless steel piston rod and nut aluminium piston	
■ 25	Compact cylinder centre distances to ISO male piston rod	●● + 6 Single-acting through-rod piston rod perforated						
■ 26	Compact cylinder centre distances to ISO female piston rod	▼ 7 Double-acting non-rotating through-rod non-rotating						

- ◆ In the code of cylinder with letter in fourth position Ø 100 becomes A1
- Codes only for cylinders Ø 32 to 100
- Can also be used as double-acting with spring return
- + Available from Ø 20
- ▼ For versions 24 and 26 only (female piston rod)
- ▲ For Ø 12 to 25 the standard version (0 or S) it's already "No stick-slip"
- For Ø 20 to 100 version with gaskets in FKM / FPM (0 or S) is already "No stick-slip"
- For speeds lower than 0.2 m/s, to prevent surging. Use no-lubricated air only**
- ▶ Only for standard double acting and standard through rod double acting version (for Ø 20 and Ø 25 only "non-magnetic" version provided)
- Compulsory for Ø 20 and Ø 25 version Z
- \* Only for Ø 32 to 100 P version (Polyurethane gaskets)
- ▷ Only for Ø 12 to 100 P version (Polyurethane gaskets)
- ◁ Only for Ø 32 to 100 V version (FKM/FPM gaskets)
- Only for Ø 20 to 100 V version (FKM/FPM gaskets)

- The ordering codes for a Multi-position cylinder is a combination of several codes, each describing a stage.

**Coding example for a UNITOP multiposition cylinder**  
**2 stages Ø 20 strokes 40 + 10 (total stroke 50 mm) male rod:**  
 1° STAGE (P): 230020P040XP +  
 2° STAGE (R): 230020R050XP

**Coding example for a UNITOP multiposition cylinder**  
**3 stages Ø 20 strokes 15 + 30 + 40 (total stroke 85 mm) male rod:**  
 1° STAGE (P): 230025P015XP +  
 2° STAGE (R): 230025R030XP +  
 3° STAGE (T): 230025T085XP

### STROKES

Standard stroke for single-acting cylinders	Standard stroke for other types	Max. recommended strokes for other types	Max. recommended strokes for non-rotating cylinders	Max recommended strokes for through-rod perforated
Ø 12 → 5 to 10 mm	Ø 12 to 16 → from 5 to 40 mm	Ø 12 to 25 → 200 mm	Ø 12 to 63 → 120 mm	Ø 20 to 40 → from 5 to 80 mm
Ø 16 to 100 → 5 to 25 mm	Ø 20 to 25 → from 5 to 50 mm	Ø 32 to 40 → 300 mm	Ø 80 to 100 → 150 mm	Ø 50 to 63 → from 5 to 100 mm
	Ø 32 to 100 → from 5 to 80 mm	Ø 50 to 63 → 400 mm		Ø 80 to 100 → from 5 to 160 mm
		Ø 80 to 100 → 500 mm		

Maximum recommended strokes. Higher values can create operating problems

## COMPACT CYLINDERS SERIES CMPC TWO-FLAT

TECHNICAL DATA		POLYURETHANE	
Max operating pressure	bar	10	
	MPa	1	
	psi	145	
Temperature range	°C	-10 to +80	
Fluid		Unlubricated air. Lubrication, if used, must be continuous	
Bores	mm	32; 40; 50; 63; 80 with ISO 15552 fixing centre distances	
	mm	32; 40; 50; 63; 80 with NFE 49-004-1 and 2 fixing centre distances	
Design		With profile, heads with screws	
Maximum strokes †	mm	Ø 32-40 = 300; Ø 50-63 = 400; Ø 80 = 500	
Versions		Double-acting, Double-acting Through-rod	
Magnet for sensors		All versions come complete with magnet. Supplied without magnet on request	
Inrush pressure	bar	Ø 32 = 0.8; from Ø 40 to 80 = 0.6	
Max torque on piston rod	Nm	Ø 32 and 40 = 0.2; Ø 50 and 63 = 0.4; Ø 80 = 1	
Maximum rotation on the rod	degrees	Ø 32 and 40 = 1° 30'; Ø 50 and 63 = 1° 30'; Ø 80 = 1°	
Notes		† Maximum recommended strokes. Higher values can create operating problems <b>For speeds lower than 0.2 m/s to prevent surging, use the version No stick-slip and non-lubricated air.</b>	

### KEY TO CODES

CYL	2 3 TYPE	1	0	3 2 BORE	0	0 5 0 STROKE *	F MATERIAL	P GASKETS
23	Compact cylinder centre distances to UNITOP male piston rod	0 Double-acting 1 Double-acting through-rod	0 Magnetic S Non-magnetic ▲ G No stick-slip	32 40 50 63 80	0 Standard		F "Two-Flat" piston rod AISI 303 stainless steel	P Polyurethane gaskets
24	Compact cylinder centre distances to UNITOP female piston rod							
25	Compact cylinder centre distances to ISO male piston rod							
26	Compact cylinder centre distances to ISO female piston rod							

\* For the maximum supplyable strokes, look at the technical data

▲ For speeds lower than 0.2 m/s, to prevent surging. Use no-lubricated air only

## COMPACT STOPPER CYLINDER

TECHNICAL DATA			
Max operating pressure	bar	10	
	MPa	1	
	psi	145	
Temperature range	°C	-10 to +80	
Fluid		Unlubricated air. Lubrication, if used, must be continuous	
Stroke bore	mm	Ø 20 x 15; Ø 32 x 20; Ø 50 x 30; Ø 80 x 30; Ø 80 x 40 a with NFE 49-004-1 and 2 fixing centre distances (UNITOP)	
	mm	Ø 32 x 20; Ø 50 x 30; Ø 80 x 30; Ø 80 x 40 with ISO 15552 fixing centre distances	
Design		With profile, heads with screws	
Versions		Single-acting extended rod. Can be also used as double-acting with spring return	
Magnet for sensors		All versions come complete with magnet. Supplied without magnet on request	
Inrush pressure	bar	Ø 20: 1.2; Ø 32-50: 1; Ø 80: 0.5	
Notes		For correct operation, it is advisable to use 50 µm filtered air	

Code	Description	Code	Description	Code	Description
23B0200015XP	Stopper cyl. trunnion D.20 C.15	23C0200015XP	Stopper cyl. roller D.20 C.15	23CS200015XP	Stopper cyl. roller SM D.20 C.15
25B0320020XP	Stopper cyl. trunnion D.32 C.20 ISO 15552	25C0320020XP	Stopper cyl. roller D.32 C.20 ISO 15552	23CS320020XP	Stopper cyl. roller SM D.32 C.20 UNITOP
23B0320020XP	Stopper cyl. trunnion D.32 C.20 UNITOP	23C0320020XP	Stopper cyl. roller D.32 C.20 UNITOP	25CS320020XP	Stopper cyl. roller SM D.32 C.20 ISO 15552
25B0500030XP	Stopper cyl. trunnion D.50 C.30 ISO 15552	25C0500030XP	Stopper cyl. roller D.50 C.30 ISO 15552	23CS500030XP	Stopper cyl. roller SM D.50 C.30 UNITOP
23B0500030XP	Stopper cyl. trunnion D.50 C.30 UNITOP	23C0500030XP	Stopper cyl. roller D.50 C.30 UNITOP	25CS500030XP	Stopper cyl. roller SM D.50 C.30 ISO 15552
23B5200015XP	Stopper cyl. trunnion SM D.20 C.15	25C0800030XP	Stopper cyl. roller D.80 C.30 ISO 15552	25CS800030XP	Stopper cyl. roller SM D.80 C.30 UNITOP
23B5320020XP	Stopper cyl. trunnion SM D.32 C.20 UNITOP	23C0800030XP	Stopper cyl. roller D.80 C.30 UNITOP	23CS800030XP	Stopper cyl. roller SM D.80 C.30 ISO 15552
25B5320020XP	Stopper cyl. trunnion SM D.32 C.20 ISO 15552	25C0800040XP	Stopper cyl. roller D.80 C.40 ISO 15552	25CS800040XP	Stopper cyl. roller SM D.80 C.40 UNITOP
23B5500030XP	Stopper cyl. trunnion SM D.50 C.30 UNITOP	23C0800040XP	Stopper cyl. roller D.80 C.40 UNITOP	23CS800040XP	Stopper cyl. roller SM D.80 C.40 ISO 15552
25B5500030XP	Stopper cyl. trunnion SM D.50 C.30 ISO 15552				

## PISTON ROD ACCESSORIES

			FORK MODEL GK-M	COMPENSATION JOINT MODEL GA	ROD EYE MODEL GA-M	SELF ALIGNING ROD COUPLER - MODEL GA-K
LINER	CMPC	Ø ROD				
20-25	12	M6	W0950120020	-	W0950120025	W0950120030
	16	M8	W0950200020	-	W0950200025	W0950200030
32-40	20-25 / 32-40	M10X1.25	W0950322020	W0950326021	W0950322025	W0950322030
50-63	50-63	M12X1.25	W0950402020	W0950406021	W0950402025	W0950402030
80-100	80	M16X1.25	W0950502020	W0950506021	W0950502025	W0950502030
	100	M20X1.25	W0950802020	W0950806021	W0950802025	W0950802030



## BODY ACCESSORIES EXAMPLE: W0950322006

### FOOT - MODEL A

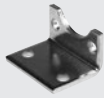

Code  
**W095\_2001** ISO 32 to 100 - UNITOP 32  
**W095\_6001** UNITOP 40 to 100  
**W095\_6001** UNITOP TF 40 to 63  
**W0950126001** UNITOP 12-16

### FEMALE HINGE - MODEL B



Code  
**W095\_2003** ISO 32 to 100 - UNITOP 32  
**W095\_6003** UNITOP 40 to 100

### MALE HINGE - MODEL BA



Code  
**W095\_6004** UNITOP 20-25  
**W095\_2004** ISO Ø 32 - 100  
**W0950126004** UNITOP 12-16

### FLANGE - MODEL C



Code  
**W095\_2002** ISO 32 to 100  
**W095\_6002** UNITOP 40 to 100  
**W095\_6002F** UNITOP TF 40 to 63  
**W095\_6302** UNITOP STOPPER 32 to 80 - ISO 32  
**W095\_6312** ISO STOPPER 50-80

### ARTICULATED MALE HINGE MODEL BAS



Code  
**W095\_2006** ISO 32 to 100

### FLANGE FOR OPPOSITE CYLINDERS



Code  
**095\_3060** UNITOP 20 to 100  
**095\_3061** ISO 32 to 100  
**0950123060** UNITOP 12 to 25

### COUNTER-HINGE CETOP Ø 32 to 100



Code  
**W095\_2008** UNITOP - ISO

### COUNTER-HINGE Ø 16 to 25 MODEL BC



Code Description  
**W0950120005** Mod. BC 12/16  
**W0950200005** Mod. BC 20/25

### LTS POSITION SENSOR

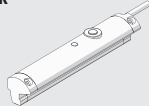

Model For cylinders  
**LTS** SERIE LINER - CMPC

For technical data and usage strokes see page 84.

## SPARE PARTS FOR ISO 21287 CYLINDERS

### COMPACT CYLINDERS ISO 21287 (POLYURETHANE)

Code	Bores	Type
009...L001	Ø 20 to 100	Complete set of gaskets polyurethane
009...L008	Ø 20 to 100	Complete set of gaskets FKM/FPM (high temperature)
009...7013	Ø 20 to 100	Polyurethane piston rod gasket kit
009...7014	Ø 20 to 100	FKM/FPM piston rod gasket
009...L101	Ø 20 to 100	Front head kit
009...L201	Ø 20 to 100	Rear head kit
009...7401	Ø 20, 25, 80, 100	Piston kit polyurethane
009...L401	Ø 32 to 63	Piston kit polyurethane
009...7501	Ø 20, 25, 80, 100	Magnet
009...L501	Ø 32 to 63	Magnet
009...L901	Ø 20 to 100	Front + rear cylinder head + piston kit polyurethane

EXAMPLE: 009032L001

## SPARE PARTS FOR COMPACT CYLINDERS

### COMPACT CYLINDERS, STOPPER

Code	Bores	Type
009...7060	Ø 20; 32; 50; 80	Complete set of gaskets
009...7160	Ø 20; 32; 50; 80	Front cylinder head kit for UNITOP
0090327160	Ø 32	Front cylinder head kit for ISO Ø 32
009...8160	Ø 50; 80	Front cylinder head kit for ISO
009...7201	Ø 20; 32	Rear cylinder head kit for UNITOP Ø 20 - Ø 32
009...7260	Ø 50; 80	Rear cylinder head kit for UNITOP
0090327201	Ø 32	Rear cylinder head kit for ISO Ø 32
009...8260	Ø 50; 80	Rear cylinder head kit for ISO
0090207401	Ø 20	Piston kit Ø 20
009...7460	Ø 32; 50; 80	Piston kit
009...7501	Ø 20; 32; 50; 80	Magnet
009...7960	Ø 20; 32; 50; 80	Front + rear cylinder head + piston kit for UNITOP
0090327960	Ø 32	Front + rear cylinder head + piston kit for ISO Ø 32
009...8960	Ø 50; 80	Front + rear cylinder head + piston kit for ISO

EXAMPLE: 0090327060

### COMPACT CYLINDERS, SERIES CMPC

Code	Bores	Type
009...7001	Ø 12 to 100	Complete set of gaskets polyurethane
009...7008	Ø 20 to 100	Complete set of gaskets FKM/FPM (high temperature)
009...7101	Ø 12 to 100	Front cylinder head kit for UNITOP polyurethane
009...7013	Ø 12 to 100	Polyurethane piston rod gasket kit
009...7014	Ø 20 to 100	FKM/FPM piston rod gasket
0090327101	Ø 32	Front cylinder head kit for ISO Ø 32 polyurethane
009...8101	Ø 40 to 100	Front cylinder head kit for ISO polyurethane
009...7201	Ø 12 to 100	Rear cylinder head kit for UNITOP polyurethane
0090327201	Ø 32	Rear cylinder head kit for ISO Ø 32 polyurethane
009...8201	Ø 40 to 100	Rear cylinder head kit for ISO polyurethane
009...7401	Ø 12 to 100	Piston kit polyurethane
009...7501	Ø 12 to 100	Magnet
009...7901	Ø 12 to 100	Front + rear cylinder head + piston kit for UNITOP polyurethane
0090327901	Ø 32	Front + rear cylinder head + piston kit for ISO Ø 32 polyurethane
009...8901	Ø 40 to 100	Front + rear cylinder head + piston kit for ISO polyurethane

EXAMPLE: 0090327001

### COMPACT CYLINDERS, SERIES CMPC TWO-FLAT

Code	Bores	Type
009...7001F	Ø 32 to 80	Set of gaskets
009...7101F	Ø 40 to 80	Front cylinder head kit for UNITOP
0090327101F	Ø 32	Front cylinder head kit for ISO Ø 32
009...8101F	Ø 40 to 80	Front cylinder head kit for ISO
009...7201	Ø 40 to 80	Rear cylinder head kit for UNITOP
0090327201	Ø 32	Rear cylinder head kit for ISO Ø 32
009...8201	Ø 40 to 80	Rear cylinder head kit for ISO
009...7401	Ø 32 to 80	Piston kit
009...7501	Ø 32 to 80	Magnet
009...7901F	Ø 40 to 80	Front + rear cylinder head + piston kit for UNITOP
0090327901F	Ø 32	Front + rear cylinder head + piston kit for ISO Ø 32
009...8901F	Ø 40 to 80	Front + rear cylinder head + piston kit for ISO

EXAMPLE: 0090327001F

## ROUND CYLINDER SERIES RNDC

ACTUATORS

ROUND CYLINDER SERIES RNDC



TECHNICAL DATA		POLYURETHANE	NBR	FKM/FPM	LOW TEMPERATURE
Max operating pressure	bar	10	10	10	10
	MPa	1	1	1	1
	psi	145	145	145	145
Temperature range	°C	-20 to +80	-10 to +80	-10 to +150 (non-magnetic cylinders)	-35 to +80
Fluid		Unlubricated air. Lubrication, if used, must be continuous			
Bores	mm	32; 40; 50			
Design		Screwed heads			
Versions		Double-acting, Double-acting through-rod, Double-acting cushioned, Double-acting through-rod cushioned, Single-acting, Single-acting through-rod, No stick-slip			
Magnet for sensors		All versions come complete with magnet. Supplied without magnet on request			
Standard strokes $\ddagger$	mm	Single-acting: for bores $\varnothing$ 32 to 50 strokes from 1 to 250 Double-acting: for bores $\varnothing$ 32 to 50 strokes from 1 to 500			
Inrush pressure	bar	$\varnothing$ 32 e 40: 0.4 - $\varnothing$ 50: 0.3			
Notes		<p><b>For speeds lower than 0.2 m/s to prevent surging, use the version No stick-slip and non-lubricated air.</b></p> <p><math>\ddagger</math> Maximum recommended strokes. Higher values can create operating problems</p>			

### KEY TO CODES

CYL	1 1 2	0	3 2	0 0 2 5	C	P
	TYPE		BORE	STROKE	MATERIAL	GASKETS
■ 104	SE through-rod	0 Standard	32	For the maximum suppliable strokes, look at the technical data	A C45 chrome rod, aluminium piston rod	P polyurethane
109	DEA	▲ G No stick-slip	40		C C45 chrome rod, technopolymer piston rod	N NBR
110	DE	S Non-magnetic	50		Z Stainless steel piston rod and nut aluminium piston	● V FKM/FPM
■ 111	SE				X Stainless steel piston rod and nut technopolymer piston	● B low temperature
112	DEM					
113	DEMA					
114	DEM through-rod					
115	DEMA through-rod					

DE: Double-acting (non-cushioned, not magnetic)  
 DEM: Magnetic double-acting (non-cushioned)  
 DEMA: Magnetic double-acting (cushioned)  
 DEA: Cushioned double-acting (non-magnetic)  
 SE: Single-acting (magnetic)

- Only available for non-magnetic versions (S) and with aluminium piston (A or Z)
- ▲ For speeds lower than 0.2 m/s, to prevent surging. Use no-lubricated air only
- Only available for versions with aluminium piston (A or Z)

### ACCESSORIES EXAMPLE: W095320002

FOOT - MODEL LC



Code  
W0950\_0002

FORK - MODEL GK-M



Code  
W0950\_2020

SELF ALIGNING ROD COUPLER - MODEL GA-K



Code  
W0950\_2030

COUNTER-HINGE - MODEL BC



Code  
W0950\_0005

ROD EYE - MODEL GA-M



Code  
W0950\_2025

HEAD LOCK RING - MODEL G



Code  
W0950\_0010

COMPENSATION JOINT - MODEL GA



Code  
W0950\_6021

## SHORT-STROKE CYLINDERS SERIES SSCY



TECHNICAL DATA		POLYURETHANE	NBR	FKM/FPM	LOW TEMPERATURE						
Max operating pressure	bar	10	10	10	10						
	MPa	1	1	1	1						
Temperature range	°C	-10 to +80	-10 to +80	-10 to +150 (non-magnetic cylinders)	-35 to +80						
Fluid		Unlubricated air. Lubrication, if used, must be continuous									
Bores	mm	12; 16; 20; 25; 32; 40; 50; 63; 80; 100									
Design		With profile									
Standard strokes $\ddagger$	mm	Double acting:	$\varnothing$ 12 to $\varnothing$ 25, stroke 5 to 50 mm $\varnothing$ 32 to $\varnothing$ 40, stroke 5 to 70 mm $\varnothing$ 50 to $\varnothing$ 63, stroke 5 to 110 mm $\varnothing$ 80 to $\varnothing$ 100, stroke 5 to 150 mm								
		Single-acting:	$\varnothing$ 12 to $\varnothing$ 25, stroke 5 to 25 mm $\varnothing$ 32 to $\varnothing$ 63, stroke 5 to 50 mm								
		Anti-rotation:	$\varnothing$ 12 to $\varnothing$ 63, stroke 5 to 120 mm $\varnothing$ 80 to $\varnothing$ 100, stroke 5 to 150 mm								
		Perforated through-rod:	$\varnothing$ 20 to $\varnothing$ 40, stroke 5 to 100 mm $\varnothing$ 50 to $\varnothing$ 63, stroke 5 to 130 mm $\varnothing$ 80 to $\varnothing$ 100, stroke 5 to 165 mm								
Versions		Double-acting, Double-acting through-rod, Single-acting retracted piston rod, Single acting extended piston rod, Single-acting through-rod, Perforated through-rod, Anti-rotation, Oscillating male, Oscillating female, No stick-slip									
Magnet for sensors		All versions come complete with magnet. Supplied without magnet on request									
Inrush pressure		$\varnothing$ 12	$\varnothing$ 16	$\varnothing$ 20	$\varnothing$ 25	$\varnothing$ 32	$\varnothing$ 40	$\varnothing$ 50	$\varnothing$ 63	$\varnothing$ 80	$\varnothing$ 100
single piston rod	bar	0.6	0.6	0.6	0.6	0.6	0.4	0.4	0.4	0.4	0.4
through-rod	bar	1	0.8	0.8	0.8	0.6	0.4	0.4	0.4	0.4	0.4
Notes		<b>For speeds lower than 0.2 m/s to prevent surging, use the version No stick-slip and non-lubricated air.</b> $\ddagger$ Maximum recommended strokes. Higher values can create operating problems									

### KEY TO CODES

CYL	2 1 2 TYPE	0	4 0 BORE	0 0 1 0 STROKE	C MATERIAL	P GASKETS
■	208 Single-acting retracted rod, non-magnetic	0 Standard	12	For the maximum applicable strokes, look at the technical data	C C45 chrome rod, aluminium piston rod $\varnothing$ 12 to 63 mm	P Polyurethane gaskets
■	209 Single-acting extended rod, non-magnetic	S Non-magnetic	16		A C45 chrome rod, technopolymer piston rod (standard $\varnothing$ 80 to 100 mm)	N NBR gaskets
■	210 Single-acting, retracted rod	▲ G No stick-slip	20		X Stainless steel piston rod and nut	● V FKM/FPM gaskets
■	211 Single-acting, extended rod		25		Z Stainless steel piston rod and nut	● B Low temperature
■	212 Double-acting, magnetic		32			
■	213 Double-acting, non-magnetic		40			
■	214 Double-acting, through-rod		50			
■	215 Single-acting, retracted, anti-rotation		63			
■	217 Double-acting, anti-rotation		80			
▼	218 Double-acting, perforated through-rod		100			
■	221 Oscillating male hinge (up to $\varnothing$ 63 only)					
■	222 Oscillating female hinge (up to $\varnothing$ 63 only)					
■	223 Single-acting, through-rod					

- ◆ In the code of cylinder with letter in fourth position  $\varnothing$  100 becomes A1
- Available up to  $\varnothing$  63
- ▼ Available from  $\varnothing$  20

- Only available for non-magnetic versions (S) and with aluminium piston (A or Z)
- ▲ For speeds lower than 0.2 m/s, to prevent surging. Use no-lubricated air only

### ACCESSORIES EXAMPLE: 21903200

#### MALE NIPPLE



Code  
2190\_\_00

### SPARE PARTS EXAMPLE: 0090320010

Code	Bores	Type
009 ... 0010	$\varnothing$ 12 to 100	Complete polyurethane front head kit
009 ... 0011	$\varnothing$ 12 to 100	Complete NBR front head kit
009 ... 0015	$\varnothing$ 12 to 100	Complete NBR rear head kit
009 ... 0021	$\varnothing$ 12 to 100	Complete polyurethane piston kit
009 ... 0023	$\varnothing$ 12 to 100	Complete NBR piston kit
009 ... 0005	$\varnothing$ 12 to 100	Complete set of polyurethane gaskets
009 ... 0006	$\varnothing$ 12 to 100	Complete set of NBR gaskets
009 ... 0007	$\varnothing$ 12 to 100	Complete set of (high temperature) FKM/FPM gaskets
009 ... 2008	$\varnothing$ 12 to 63	Polyurethane piston rod gasket kit
009 ... 2008	$\varnothing$ 80 to 100	Polyurethane piston rod gasket kit + seeger
009 ... 2009	$\varnothing$ 12 to 63	NBR piston rod gasket kit
009 ... 2009	$\varnothing$ 80 to 100	NBR piston rod gasket kit + seeger
009 ... 2010	$\varnothing$ 12 to 63	FKM/FPM piston rod gasket kit
009 ... 2010	$\varnothing$ 80 to 100	FKM/FPM piston rod gasket kit + seeger
009 ... 0031	$\varnothing$ 12 to 100	Complete polyurethane front+rear head kit + piston
009 ... 0033	$\varnothing$ 12 to 100	Complete NBR front + rear head kit + piston
009 ... 0001	$\varnothing$ 12 to 100	Magnet

## CARTRIDGE MICRO-CYLINDER SERIES CRTC



TECHNICAL DATA		WEIGHT		
Operating pressure	bar	2 to 6		
	MPa	0.2 to 0.6		
Temperature range	°C	-10 to +80		
Fluid		Lubricated or unlubricated air. Lubrication, if used, must be continuous		
Bores	mm	6; 10; 16		
Strokes	mm	5; 10; 15		
Port		M5		
Versions		Single-acting		
Design		Mechanically edged		
Seal OR on the body (not included in the supply)		Ø 6 : 7 x 1; Ø 10 : 9.5 x 1.5; Ø 16 : 16 x 1.5		
			<b>Ø</b>	<b>STROKE</b>
			5	10
			14 g	16 g
			30 g	35 g
			76 g	84 g
			19 g	90 g

### KEY TO CODES

CIL	C R T C	0 1 0	0 0 1 0	S 0 0 0	0 0	0 0
	TYPE	DIAMETER	STROKE	TYPE	FURTHER DESCRIPTION	SPECIAL DESIGN
	Cartridge microcylinder	006 010 016	0005 0010 0015	Single-acting retracted piston rod	Not provided	Not provided
<b>Code</b>	<b>Description</b>	<b>Code</b>	<b>Description</b>	<b>Code</b>	<b>Description</b>	
W1000060005	Cyl. CRTC-006-0005-S000-00	W1000100005	Cyl. CRTC-010-0005-S000-00	W1000160005	Cyl. CRTC-016-0005-S000-00	
W1000060010	Cyl. CRTC-006-0010-S000-00	W1000100010	Cyl. CRTC-010-0010-S000-00	W1000160010	Cyl. CRTC-016-0010-S000-00	
W1000060015	Cyl. CRTC-006-0015-S000-00	W1000100015	Cyl. CRTC-010-0015-S000-00	W1000160015	Cyl. CRTC-016-0015-S000-00	

## COMPACT GUIDED CYLINDERS SERIES CMPG



TECHNICAL DATA		CUSHIONED	NO-CUSHIONED
Operating pressure	bar	1 to 10	
	MPa	0.1 to 1	
	psi	14.5 to 145	
Temperature range	°C	-10 to +80	
	°F	14 to 176	
Fluid		Unlubricated air. Lubrication, if used, must be continuous	
Bores	mm	16; 20; 25; 32; 40; 50; 63	16; 20; 25; 32; 40; 50; 63; 80; 100
Strokes	mm	Ø 16: 20-30-40-50	Ø 16: 10-20-25-30-40-50-75-100-150-200
		Ø 20; Ø 25: 20-30-40-50-75-100-150	Ø 20; Ø 25: 20-25-30-40-50-75-100-150-200
		Ø 32 to Ø 63: 25-50-75-100-150-175	Ø 32 to Ø 100: 25-50-75-100-150-200
			Other strokes on request but with the same cylinder dimensions as the standard stroke immediately above
Version		With bronze bushings With ball bearings	

### KEY TO CODES

W 1 4 3	0 3 2	2	0 2 5
TYPE	DIAMETER	VERSION	STROKE
16	16	2 Bronze bushings	CUSHIONED VERSION
20	20	3 Ball bearings	Ø 16: 20, 30, 40, 50
25	25	4 Cushioned with bronze bushings	Ø 20 to 25: 20, 30, 40, 50, 75, 100, 150
32	32	5 Cushioned with ball bearings	Ø 32 to 63: 25, 50, 75, 100, 150, 175
40	40		NOT CUSHIONED VERSION ♦
50	50		Ø 16: 10, 20, 25, 30, 40, 50, 75, 100, 150, 200
63	63		Ø 20 to 25: 20, 25, 30, 40, 50, 75, 100, 150, 200
* 80	* 80		Ø 32 to 100: 25, 50, 75, 100, 150, 200
* A1=100	* A1=100		

\* Not cushioned version only

♦ Other strokes on request but with the same cylinder dimensions as the standard stroke immediately above.

## RODLESS CYLINDER



### RODLESS CYLINDER SERIES STD

TECHNICAL DATA		NBR	FKM/FPM
Operating pressure	bar		1 to 8
	MPa		0.1 to 0.8
Temperature range	psi		14.5 to 116
	°C		-10 to +80
	°F		14 to 176
Fluid		50 µm unlubricated filtered air Lubrication, if used, must be continuous.	
Bores	mm	Ø 16, 25, 32, 40, 63	
Type of construction		Double-acting rodless cylinder with direct transmission system	
Strokes	mm	Ø 16: from 100 to 5000 with 1mm interval	
		Ø 25, 32 e 40: from 100 to 5700 with 1mm interval	
		Ø 63: from 100 to 5500 with 1mm interval	
Recommended speeds	m/s	<1	≥1
Max. speed with decelerators	m/s	<1	2
Notes		For speeds lower than 0.2 m/s to prevent surging, use the version No stick-slip and non-lubricated air.	

#### KEY TO CODES

CYL	27 TYPE	0	0	2 5 BORE	0 1 5 0 STROKE	C	N GASKETS
	27 Rodless cylinder	0 Standard 1 With swing drive + 2 Twin cushioned series "Double" 3 Double-acting cushioned Magnetic + adjustable limit switches and shock absorbers	0 Magnetic S Non-magnetic ■ G No stick-slip	16 25 32 40 63	Ø 16: from 100 to 5000 mm Ø 25 to 40: from 100 to 5700 mm Ø 63 from 100 to 5500 mm		N NBR gasket ● V FKM/FPM gasket

■ For speeds lower than 0.2 m/s, to prevent surging. Use no-lubricated air only ● For speed ≥ 1/m/s + Available up to Ø 32

### RODLESS CYLINDER WITH BALL RECIRCULATING GUIDE

TECHNICAL DATA		NBR	FKM/FPM
Operating pressure	bar		1 to 8
	MPa		0.1 to 0.8
Temperature range	Psi		7 to 116
	°C		-10 to +80
	°F		14 to 176
Fluid		50 µm unlubricated filtered air lubrication, if used, must be continuous	
Bores	mm	Ø 16, 25, 32, 40, 63	
Type of construction		Double-acting rodless cylinder with direct transmission system	
Strokes	mm	Ø 16: from 100 to 1350 with 1 interval	
		Ø 25: from 100 to 2300 with 1 interval	
		Ø 32: from 100 to 2300 with 1 interval	
		Ø 40: from 100 to 2250 with 1 interval	
		Ø 63 standard: from 100 to 2100 with 1 interval	
		Ø 63 heavy: from 100 to 2650 with 1 interval	
Threaded ports		M5, G1/8", G1/4", G3/8"	
Assembly		In any position	
Recommended speed	m/s	<1	≥1
Max. speed with decelerators	m/s	<1	2
Notes		For speeds lower than 0.2 m/s to prevent surging, use the version No stick-slip	

#### KEY TO CODES

CYL	27 TYPE	5	0	2 5 BORE	0 1 5 0 STROKE	C	N GASKETS
	27 Rodless cylinder	5 Double-acting cushioned magnetic with ball circulation guides 6 Double-acting cushioned magnetic with ball circulation guides + adjustable limit switch and shock absorbers	0 STD Magnetic S STD Non-magnetic ■ G STD No stick-slip A HEAVY Magnetic ■ B HEAVY No stick-slip C HEAVY Non-magnetic	16 25 32 40 63	Ø 16: 100 to 1350 mm Ø 25 - 32: 100 to 2300 mm Ø 40: 100 to 2250 mm Ø 63 std: 100 to 2100 mm Ø 63 heavy: 100 to 2650 mm		N NBR gasket ● V FKM/FPM gasket

■ For speeds lower than 0.2 m/s, to prevent surging. Use no-lubricated air only ● For speed ≥ 1/m/s

## RODLESS CYLINDER WITH "V" GUIDE

TECHNICAL DATA		NBR	FKM/FPM
Operating pressure	bar		1.5 to 8
	MPa		0.15 to 0.8
	psi		21.8 to 116
Temperature range	°C		-10 to +80
	°F		14 to 176
			50 µm unlubricated filtered air Lubrication, if used, must be continuous
Fluid			
Bores	mm		Ø 25, 32, 40, 63
Type of construction			Double-acting rodless cylinder with direct transmission system
Strokes	mm		Ø 25, 32 and 40: from 100 to 5700 with 1mm interval
			Ø 63: from 100 to 5500 with 1mm interval
Recommended speeds		< 1	≥ 1
Max. speed with decelerators		< 1	2
Notes		For speeds lower than 0.2 m/s to prevent surging, use the version No stick-slip and non-lubricated air.	

### KEY TO CODES

CYL	2 7	7	0	2 5	0 1 5 0	C	N
	TYPE			BORE	STROKE		GASKETS
	27 Rodless cylinder	7 Double-acting cushioned Magnetic with "V" guide 8 Double-acting cushioned Magnetic with "V" guide + adjustable limit switches and decelerator	0 Magnetic S Non-magnetic * G No stick-slip	25 32 40 63	Ø 25 to 40: from 100 to 5700 mm Ø 63: from 100 to 5500 mm		N NBR gasket ● V FKM/FPM gasket

\* For speeds lower than 0.2 m/s, to prevent surging. Use no-lubricated air only ● For speed ≥ 1/m/s

## ACCESSORIES EXAMPLE: W0950327001

<p><b>FOOT</b></p> <p>Code W095__7001</p>	<p><b>DOUBLE FOOT</b></p> <p>Code Description W0950168001 Acc. double foot D.16 W0950258001 Acc. double foot D.25 W0950328036 Acc. double foot D.32</p>	<p><b>ADJUSTABLE LIMIT SWITCH AND SHOCK ABSORBERS KIT</b></p> <p>Code Description 095__4002 Rodless cylinder limit switch and shock absorbers</p>
<p><b>INTERMEDIATE FOOT 16/25</b></p> <p>Code W095__7031 0950254094 For the "V" guide Ø 25</p>	<p><b>DOUBLE VERTICAL FOOT</b></p> <p>Code Description W0950328035 Acc. double vertical foot D.032</p>	<p><b>ADJUSTABLE LIMIT SWITCH AND SHOCK ABSORBERS KIT FOR RODLESS CYLINDER WITH "V" GUIDE</b></p> <p>Code Description 095__4004 Rodless cylinder limit switch and shock absorbers</p>
<p><b>INTERMEDIATE FOOT</b></p> <p>Code W095__7032 W095__4004 For ball ricirculating</p>	<p><b>SENSOR SUPPORT Ø 16 FOR RODLESS CYLINDER WITH RECIRCULATING BALL</b></p> <p>Code Description 0950164003 Sensor support short 0950164001 Sensor support std</p>	<p><b>SHOCK ABSORBERS</b></p> <p>Code Ø Description 0950004003 16 Shock absorbers ECO15 MF1 + nut M12x1 0950004004 25 Shock absorbers ECO25 MC2 + nut M14x1.5 0950004005 32 Shock absorbers ECO50 MC2 + nut M20x1.5 0950004006 40 Shock absorbers ECO100 MF2 + nut M25x1.5 0950004007 63 Shock absorbers ECO125 MF3 + nut M36x1.5</p>
<p><b>INTERMEDIATE SUPPORT KIT Ø 63 FOR HORIZONTAL POSITION BALL RECIRCULATING</b></p> <p>Code W0950637036</p>	<p><b>DOUBLE INTERMEDIATE FOOT</b></p> <p>Code W095__8037</p>	

## ACCESSORIES FOR CONVERTING INTO SWING CYLINDERS EXAMPLE: W0950257035

<p><b>KIT TO TRANSFORM INTO SWING VERSION</b></p> <p>Code W095__7035 W0950327035 Ø 32-40</p>	<p><b>DRIVE PIN</b></p> <p>Code W095__7034 W0950327034 Ø 32-40</p>	<p><b>SWING SUPPORT</b></p> <p>Code W095__7033 W0950327033 Ø 32-40</p>
--	--	--



# SPARE PARTS FOR STD RODLESS CYLINDERS, "V" GUIDE, BALL RECIRCULATING GUIDE, DOUBLE

## "LAST RELEASE" CYLINDER

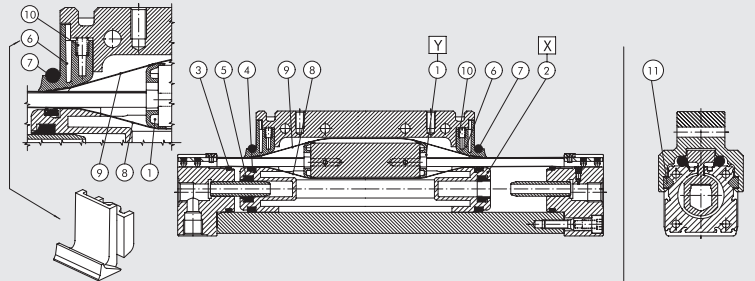
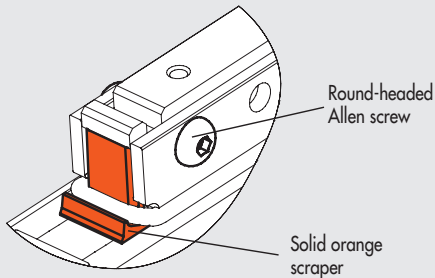

- ① Bands support Kit
- ② Piston kit
- ③ ④ ⑤ ⑥ ⑦ ⑩ NBR gaskets Kit (FKM/FPM for ⑦)
- ③ ④ ⑤ ⑥ ⑦ ⑩ FKM/FPM gaskets Kit
- ⑧ ⑨ Bands Kit (inner/outer)
- ⑪ "V" guide plate kit

Spare parts label on one cylinder side

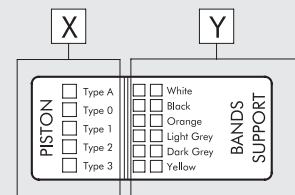

### BANDS SUPPORT KIT POS 1 (Y)

Ø	Code White	Code Black	Code Orange	Code Light grey	Code Dark grey	Code Yellow
16	0090165080	0090165081	0090165082	0090165083	0090165084	0090165085
25	0090255080	0090255081	0090255082	0090255083	0090255084	0090255085
32	0090325080	0090325081	0090325082	0090325083	0090325084	0090325085
40	0090405080	0090405081	0090405082	0090405083	0090405084	0090405085
63	0090635080	0090635081	0090635082	0090635083	0090635084	0090635085

### BANDS KIT (INNER AND OUTER) POS 8-9

Ø	Code
16	0090166....
25	0090256....
32	0090326....
40	0090406....
63	0090636....

Complete the code with the 4 figure cylinder stroke

### "V" GUIDE PLATE KIT POS 11

Ø	Code
25	0090255060
32	0090325060
40	0090325060
63	0090635060

### PISTON KIT POS 2 (X)

Ø	Code Type 0 (0 rings)	Code Type 1 (1 rings)	Code Type 2 (2 rings)	Code Type 3 (3 rings)	Code Type A (4 rings)
16	0090165015	0090165016	0090165017	0090165018	-
25	0090255015	0090255016	0090255017	0090255018	0090255019
32	0090325015	0090325016	0090325017	0090325018	0090325019
40	0090405015	0090405016	0090405017	0090405018	-
63	0090635015	0090635016	0090635017	0090635018	-

### NBR GASKET KIT POS 3-4-5-6-7-10

Ø	Code
16	0090165022
25	0090255022
32	0090325022
40	0090405022
63	0090635022

### FKM/FPM GASKET KIT POS 3-4-5-6-7-10

Ø	Code
16	0090165023
25	0090255023
32	0090325023
40	0090405023
63	0090635023

NOTES: If the ends of the carriage appear as below indicated, please contact our commercial department for the spare parts

## "INTERMEDIATE RELEASE"

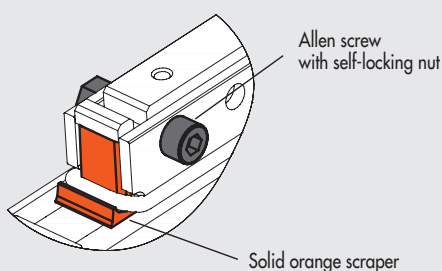

## "OLD RELEASE"

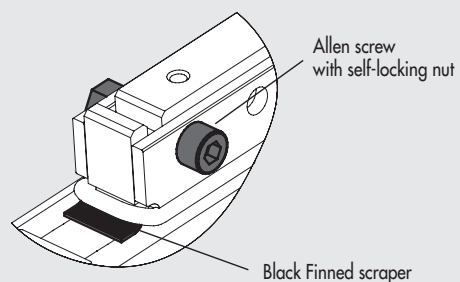

## RODLESS CYLINDER SERIES PU

STD-PU

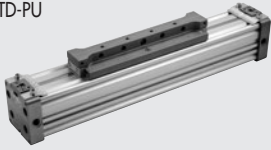

"V" GUIDE-PU

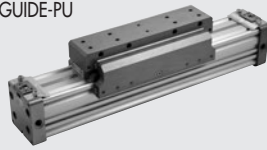

BALL RECIRCULATING-PU

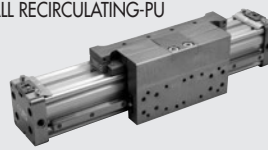

## RODLESS CYLINDER SERIES PU

### TECHNICAL DATA

Operating pressure	bar	1 to 8
	MPa	0.1 to 0.8
	psi	14.5 to 116
Temperature range	°C	-10 to +80
	°F	14 to +176
Fluid		50 µm unlubricated filtered air Lubrication, if used, must be continuous
Bores	mm	Ø 25, 32, 40, 50
Type of construction		Double-acting rodless cylinder with direct transmission system
Strokes		Ø 25 - 40: from 100 to 5700 mm with 1mm interval Ø 50: from 100 to 5600 mm with 1mm interval
Recommended speeds	m/s	< 2
Max. speed with decelerators	m/s	< 2
Notes		<b>For speeds lower than 0.2 m / s to prevent surging, use the version No stick-slip and non-lubricated air</b>

### KEY TO CODES

CYL	2 7 TYPE	0	3	2 5 BORE	0 1 0 0 STROKE	C	P GASKETS
	27 Rodless cylinder	0 Double acting cushioned magnetic 1 Double acting with swing carriage 3 Double acting + adjustable limit switch and shock absorbers	3 Magnetic 4 No stick-slip 5 Non-magnetic	25 32 40 50	Ø 25 - 40: from 100 to 5700 mm Ø 50: from 100 to 5600 mm		P Polyurethane gaskets

■ For speeds lower than 0.2 m/s, to prevent surging. Use no-lubricated air only.

## RODLESS CYLINDER WITH "V" GUIDE SERIES PU

### TECHNICAL DATA

Operating pressure	bar	1 to 8
	MPa	0.1 to 0.8
	psi	14.5 to 116
Temperature range	°C	-10 to +80
	°F	14 to +176
Fluid		50 µm unlubricated filtered air Lubrication, if used, must be continuous
Bores	mm	50
Type of construction		Double-acting rodless cylinder with direct transmission system
Strokes	mm	from 100 to 5600 mm with 1mm interval
Recommended speeds	m/s	< 2
Max. speed with decelerators	m/s	< 2
Notes		<b>For speeds lower than 0.2 m / s to prevent surging, use the version No stick-slip and non-lubricated air</b>

### KEY TO CODES

CYL	2 7 TYPE	7	3	5 0 BORE	0 1 0 0 STROKE	C	P GASKETS
	27 Rodless cylinder	7 Double acting cushioned magnetic with "V" guide 8 Double acting cushioned magnetic with "V" guide + adjustable limit switch and shock absorbers	3 Magnetic 4 No stick-slip 5 Non-magnetic	50	from 100 to 5600 mm		P Polyurethane gaskets

■ For speeds lower than 0.2 m/s, to prevent surging. Use no-lubricated air only.

## RODLESS CYLINDER WITH BALL RECIRCULATING GUIDE SERIES PU

TECHNICAL DATA		
Operating pressure	bar	1 to 8
	MPa	0.1 to 0.8
	psi	14.5 to 116
Temperature range	°C	-10 to +80
	°F	14 to 176
Fluid		50 µm unlubricated filtered air lubrication, if used, must be continuous
Bores	mm	Ø 50
Type of construction		Double-acting rodless cylinder with direct transmission system
Strokes	mm	from 100 to 2470 with 1 interval
Threaded ports		G1/4"
Assembly		As required
Recommended speed	m/s	<2
Max. speed with decelerators	m/s	<2
Notes		For speeds lower than 0.2 m / s to prevent surging, use the version No stick-slip and non-lubricated air

### KEY TO CODES

CYL	2 7 TYPE	5	3	5 0 BORE	0 1 0 0 STROKE	C	P GASKETS
	27 Rodless cylinder	5 Double-acting cushioned magnetic with ball circulation guides 6 Double-acting cushioned magnetic with ball circulation guides + adjustable limit switch and shock absorbers	3 Magnetic 4 No stick-slip 5 Non-magnetic	50	from 100 to 2470 mm		P Polyurethane gaskets

■ For speeds lower than 0.2 m/s, to prevent surging. Use no-lubricated air only.

### ACCESSORIES EXAMPLE: 0950324041

#### FOOT

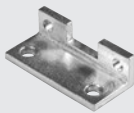

INTERMEDIATE SIDE SUPPORT FOR "V" GUIDE VERSION

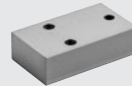

#### DUST SCRAPER KIT

Code  
095\_\_4041

Code  
0950504052

Ø	Code
25	0090255025P
32	0090255025P
40	0090405025P
50	0090505025P

Note: 2 dust scrapers

#### INTERMEDIATE FOOT FOR STD AND "V" GUIDE VERSION



#### SHOCK ABSORBERS



#### GASKET KIT

Code  
W095\_\_7038

Code	Ø	Description
0950004004	25	Shock absorbers ECO25 MC2 + nut M14x1.5
0950004005	32	Shock absorbers ECO50 MC2 + nut M20x1.5
0950004006	40-50	Shock absorbers ECO100 MF2 + nut M25x1.5

Ø	Code
25	0090255024P
32	0090325024P
40	0090405024P
50	0090505024P

Note: 2 gasket for position

#### INTERMEDIATE SUPPORT FOR BALL RECIRCULATING



#### ADJUSTABLE LIMIT SWITCH AND SHOCK ABSORBERS KIT

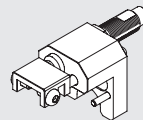

#### BANDS KIT (INNER AND OUTER)

Code  
0950504053

Code  
095\_\_4013

Description  
Rodless cylinder limit switch and shock absorbers

Ø	Code
25	0090256__P
32	0090326__P
40	0090406__P
50	0090506__P

Complete the code with the 4-figure cylinder stroke

#### SIDE INTERMEDIATE FOOT



#### ADJUSTABLE LIMIT SWITCH AND SHOCK ABSORBERS KIT FOR VERSION "V" GUIDE



#### PISTON KIT

Code  
095\_\_4051

Code  
0950504014

Description  
Rodless cylinder limit switch and shock absorbers Ø 50

Ø	Code
25	0090255009P
32	0090325009P
40	0090405009P
50	0090505009P

Note: 2 pistons

## RODLESS CYLINDER WITH MAGNETIC SLIDING SERIES MAGNETIC SLIDE

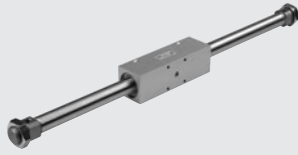

ACTUATORS

RODLESS CYLINDER WITH MAGNETIC SLIDING - SERIES MAGNETIC SLIDE

TECHNICAL DATA		Ø 16	Ø 20	Ø 25
Operating pressure	bar		2 to 7	
	MPa		0.2 to 0.7	
	psi		29 to 101	
Temperature range	°C		-10 to 60	
	°F		14 to 140	
Fluid		Unlubricated 50 µm filtered air. Lubrication, if used, must be continuous		
Bores	mm		16; 20; 25	
Strokes	mm		from 10 to 1000 with 1 intervals	
Versions			Magnetic uncushioned/cushioned	
			Swinging magnet uncushioned/cushioned	
Design		Double-acting rodless cylinder, with magnetic coupling transmission system		
Position sensing		Magnet for limit switch sensor		
Fixing		Hex nuts (supplied standard) - Legs - Flanges		
Theoretic force at 6 bar	N	118	185	288
Magnetic coupling force (static condition)	N	200	300	500
Max speed	m/s	0.4	0.4	0.4
Notes		Lubricate the slide every 2000 km or once a year, through the lubricators		

### KEY TO CODES

CYL	27 TYPE	A VERSION	0	1 6 BORE	0 0 5 0 STROKE	X MATERIAL	P GASKETS
	27 Rodless cylinder	A Magnetic sliding DEM B Magnetic sliding DEMA C Magnetic sliding swinging DEM D Magnetic sliding swinging DEMA	0 Magnetic	16 20 25	For the maximum suppliable strokes, look at the technical data	X Standard	P Polyurethane

DEM: Magnetic double-acting (non-cushioned)

DEMA: Magnetic double-acting (cushioned)

### ACCESSORIES

#### FLANGE MOD. C



Code	Ø	Description
W0950120002	16	Acc. flange Mod. C
W0950200002	20/25	Acc. flange Mod. C

#### KIT FOR SWING VERSION



Code	Ø	Description
0950164050	16	Acc. kit for swing version
0950204050	20	Acc. kit for swing version
0950254050	25	Acc. kit for swing version

#### FOOT



Code	Ø	Description
0950164040	16	Acc. foot
0950204040	20/25	Acc. foot

## STAINLESS STEEL CYLINDER

RNDC CYLINDER



MINI-CYLINDER



ISO 15552 CYLINDER



## STAINLESS STEEL ISO 6432 MINI-CYLINDER

TECHNICAL DATA		POLYURETHANE	FKM/FPM
Max operating pressure	bar MPa		10
Temperature range	°C	-10 to +80	-10 to +150 (non-magnetic cylinders)
Fluid		Unlubricated air. Lubrication, if used, must be continuous	
Bores	mm	16; 20; 25	
Design		Chamfered heads	
Standard strokes <b>+</b>	mm	max 500	
Versions		Double-acting, Double-acting through-rod	
Magnet for sensors		All versions come complete with magnet. Supplied without magnet on request.	
Notes		<b>+</b> Maximum recommended strokes. Higher values can create operating problems	

### KEY TO CODES

W 1 8	0 TYPE	0 VERSION	1 6 DIAMETER	0 0 2 0 STROKE
Stainless steel cylinder	0 DEM 1 DEM through-rod	0 Standard (magnetic) S Non-magnetic ● V FKM/FPM gasket	16 20 25	<b>+</b> 0 to 500 mm

DEM: Magnetic double-acting (non-cushioned)

**+** Maximum recommended strokes. Higher values can create operating problems

● For this version the cylinder will be not magnetic

## ACCESSORIES

### STAINLESS STEEL LEG MODEL A

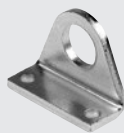

Code	Ø	Description
W095X120001	16	Acc. stainless steel leg Mod. A
W095X200001	20-25	Acc. stainless steel leg Mod. A

### STAINLESS STEEL COUNTER-HINGE MODEL BC



Code	Ø	Description
W095X120005	16	Acc. stainless steel counter-hinge Mod. BC
W095X200005	20-25	Acc. stainless steel counter-hinge Mod. BC

### STAINLESS STEEL NUT FOR PISTON RODS



Code	Ø	Description
W095X120011	16	Acc. stainless steel nut for piston rod M6
W095X200011	20	Acc. stainless steel nut for piston rod M8
W095X322011	25	Acc. stainless steel nut for piston rod M10X1.25

### STAINLESS STEEL FLANGE MODEL C



Code	Ø	Description
W095X120002	16	Acc. stainless steel flange Mod. C
W095X200002	20-25	Acc. stainless steel flange Mod. C

### STAINLESS STEEL NUT FOR HEADS



Code	Ø	Description
W095X120010	16	Acc. stainless steel nut for heads M16X1.5
W095X200010	20-25	Acc. stainless steel nut for heads M22X1.5

### STAINLESS STEEL FORK MODEL GK-M



Code	Ø	Description
W095X120020	16	Acc. stainless steel fork Mod. GK-M M6
W095X200020	20	Acc. stainless steel fork Mod. GK-M M8
W095X322020	25	Acc. stainless steel fork Mod. GK-M M10X1.25

## STAINLESS STEEL ROUND CYLINDERS RNDC

TECHNICAL DATA		POLYURETHANE	FKM/FPM
Max operating pressure	bar		10
	MPa		1
	psi		145
Temperature range	°C	-10 to +80	-10 to +150 (non-magnetic cylinders)
Fluid		Unlubricated air. Lubrication, if used, must be continuous	
Bores	mm	32; 40; 50; 63	
Design		Chamfered heads	
Versions		Double-acting, Double-acting through-rod	
Magnet for sensors		All versions come complete with magnet. Supplied without magnet on request.	
Standard strokes <b>+</b>	mm	max 500	
Notes		<b>+</b> Maximum recommended strokes. Higher values can create operating problems	

### KEY TO CODES

W 1 8	0 TYPE	0 VERSION	3 2 DIAMETER	0 0 3 2 STROKE
Stainless steel cylinder	0 DEM 1 DEM through-rod	0 Standard (magnetic) S Non-magnetic ● V FKM/FPM gasket	32 40 50 63	<b>+</b> Ø 32 to 63 stroke 0 to 500 mm

DEM: Magnetic double-acting (non-cushioned)  
**+** Maximum recommended strokes. Higher values can create operating problems  
**●** For this version the cylinder will be not magnetic

### ACCESSORIES EXAMPLE: W095X32002

STAINLESS STEEL LEG  
MODEL AC

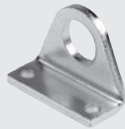

Code  
W095X\_0002

STAINLESS STEEL COUNTER-HINGE  
MODEL BC



Code  
W095X\_0005

STAINLESS STEEL HEAD RING NUT  
MODEL G



Code	Ø	Description
W095X320010	32	Acc. stainless steel head ring nut Mod. G
W095X400010	40	Acc. stainless steel head ring nut Mod. G
W095X500010	50-63	Acc. stainless steel head ring nut Mod. G

STAINLESS STEEL FORK  
MODEL GK-M



Code	Ø	Description
W095X320020	32	Acc. stainless steel fork Mod. GK-M10X1.5
W095X400020	40	Acc. stainless steel fork Mod. GK-M12X1.75
W095X500020	50-63	Acc. stainless steel fork Mod. GK-M16X2

STAINLESS STEEL NUT FOR PISTON RODS



Code	Ø	Description
W095X320011	32	Acc. stainless steel nut for piston rod M10X1.5
W095X400011	40	Acc. stainless steel nut for piston rod M12X1.75
W095X500011	50-63	Acc. stainless steel nut for piston rod M16X2

STAINLESS STEEL OSCILLATING PIN

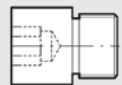

Code  
W095X\_0007



## STAINLESS STEEL ISO 15552 CYLINDERS

TECHNICAL DATA		POLYURETHANE	FKM/FPM
Max operating pressure	bar	10	
	MPa	1	
	psi	145	
Temperature range	°C	-10 to +80	-10 to +150 (non-magnetic cylinders)
Fluid		Unlubricated air. Lubrication, if used, must be continuous	
Bores	mm	32; 40; 50; 63; 80; 100; 125	
Design		Heads with tie rods	
Standard strokes †	mm	max 1000	
Versions		Double-acting cushioned, Double-acting through-rod cushioned	
Magnet for sensors		All versions come complete with magnet. Supplied without magnet on request	
Notes		† Maximum recommended strokes. Higher values can create operating problems	

### KEY TO CODES

W 1 8	4 TYPE	0 VERSION	3 2 DIAMETER	0 0 3 2 STROKE
Stainless steel cylinder	4 DEMA 5 DEMA through-rod	0 Standard (magnetic) S Non-magnetic ● V FKM/FPM gasket	32 63 40 80 50 ■ 100 ■ 125	+ 0 to 1000 mm

DEMA: Magnetic double-acting (cushioned)

† Maximum recommended strokes. Higher values can create operating problems

● For this version the cylinder will be not magnetic

■ In the code of cylinder with letter in fifth position  
Ø 100 becomes A1; Ø 125 becomes A2

## ACCESSORIES EXAMPLE: W095X322007 (FOR Ø 100 = A1 - Ø 125 = A2)

### STAINLESS STEEL INTERMEDIATE HINGE MODEL EN



Code  
W095X\_2007

### STAINLESS STEEL MALE HINGE MODEL BA



Code  
W095X\_2004

### STAINLESS STEEL FORK MODEL GK-M



Code	Ø	Description
W095X322020	32	Acc. stainless steel fork Mod. GK-M10X1.25
W095X402020	40	Acc. stainless steel fork Mod. GK-M12X1.25
W095X502020	50-63	Acc. stainless steel fork Mod. GK-M16X1.5
W095X802020	80-100	Acc. stainless steel fork Mod. GK-M20X1.5

### STAINLESS STEEL SHORT FOOT MOUNTING

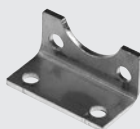

Code  
W095X\_2001

### STAINLESS STEEL ISO COUNTER-HINGE FOR MODEL B - MODEL GL



Code  
W095X\_2008

### SENSOR BRACKET



Code	Description
W0950001100	Acc. stainless steel sensor bracket D. 032-125

### STAINLESS STEEL FEMALE HINGE MODEL B



Code  
W095X\_2003

### STAINLESS STEEL FRONT/REAR FLANGE MODEL C



Code  
W095X\_2002

### FEMALE HINGE INOX PIN



Code  
W095X\_2050

### STAINLESS STEEL NUT FOR PISTON RODS



Code	Ø	Description
W095X322011	32	Acc. stainless steel nut M10X1.25
W095X402011	40	Acc. stainless steel nut M12X1.25
W095X502011	50-63	Acc. stainless steel nut M16X1.5
W095X802011	80-100	Acc. stainless steel nut M20X1.5
W095XA22011	125	Acc. stainless steel nut M27x2

## GRIPPER WITH 2 PARALLEL JAWS, SERIES P1 - P2 - P3



TECHNICAL DATA		P1-20	P1-32	P2-16	P2-20	P2-25	P3-40	P3-64	STANDARD	P3-80 INCREASED FORCE	STANDARD	P3-100 INCREASED FORCE
Operating pressure	bar	2 to 8			2 to 8			2 to 8				
	MPa	0.2 to 0.8			0.2 to 0.8			0.2 to 0.8				
Temperature range	psi	29 to 116			29 to 116			29 to 116				
	°C	5 to 70			-10 to +80			-10 to 80				
Maximum operating frequency	cycles/s	-			2			-				
Fluid		20 µm filtered air, lubricated or unlubricated. If lubricated air is used, lubrication must be continuous										
Bore	mm	20	32	16	20	25	-	-	-	-	-	-
Clamping force at 6.3 bar 20 mm from the top surface during opening and closing	N	70	170	45	100	135	75	125	265	445	360	790
	kg	-	-	-	-	-	0.65	1.3	2.5	5	3.5	7
Single jaw stroke	mm	5	5	4	5	7	2.5	6	8	4	10	5
Minimum opening/closing time	s	-	-	-	-	-	0.05					
Repeatability	mm	-	-	-	-	-	0.01					
Moment of inertia	kg cm <sup>2</sup>	-	-	-	-	-	1.8	4	4.5		12	
Max. admissible static loads:												
- Fa	N	-	-	-	-	-	250	1100	1500		2000	
- Mx	Nm	-	-	-	-	-	10	40	90		80	
- My	Nm	-	-	-	-	-	5	60	55		115	
- Mz	Nm	-	-	-	-	-	12	40	55		70	
Weight	kg	0.50	0.70	0.2	0.4	0.75	0.12	0.35	0.51		0.9	

## GRIPPERS WITH 2 PARALLEL LONG-STROKE JAWS – SERIES P4



TECHNICAL DATA		P4-10	P4-12	P4-16	P4-25	P4-30
Operating pressure	bar	3 to 7				
	MPa	0.3 to 0.7				
Operating temperature	psi	43 to 101				
	°C	-10 to +80				
Maximum operating frequency	cycles/s	1				
Fluid		20 µm filtered, lubricated or unlubricated air; lubrication if used, it must be continuous				
Bore	mm	2 x 10	2 x 12	2 x 16	2 x 30	2 x 30
Single jaw stroke	mm	5	10	15	30	60
Clamping force at 6.3 bar 20 mm from the top surface during opening and closing	N	30	45	75	280	280
	kg	0.18	0.3	0.5	2.95	3.7

## GRIPPERS WITH 2 HINGED JAWS – SERIES P7 - P9



TECHNICAL DATA		P7-16	P7-20	P7-32	P7-50	P9-32	P9-40
Operating pressure	bar	2 to 10				2 to 8	
	MPa	0.2 to 1				0.2 to 0.8	
Temperature range	psi	29 to 145				29 to 116	
	°C	-10 to +80				-10 to +80	
Fluid		20 µm filtered air, lubricated or unlubricated. If lubricated air is used, lubrication must be continuous.					
Bores	mm	-	-	-	-	32	40
Jaw opening angle		Adjustable 180°					
Maximum opening angle of single jaw		15° 30'	16° 30'	16°	8° 30'		
Clamping force at 6.3 bar 20 mm from the centre of rotation of the jaws (40 mm from the jaw pivot for P9) during opening and closing	N	27	50	120	380	160	260
	kg	0.12	0.19	0.5	1.6	0.85	1.5

## TECHNOPOLYMER HINGED GRIPPERS SERIES P8



TECHNICAL DATA		P8-32	P8-40	P8-50
Operating pressure	bar		4 to 7	
	MPa		0.4 to 0.7	
Operating temperature	bar		58 to 101	
	°C		-10 to +60	
Fluid		20 µm filtered, lubricated or unlubricated air; lubrication if used, it must be continuous		
Life		Over 2 million cycles		
Jaw opening angle		8°		
Clamping force per jaw at 6 bar	N	22.5	48	80
Applicable weight (recommended)	kg	0.2	0.4	0.8
Air consumption per cycle	cm <sup>3</sup>	0.5	1	1.8
Opening time	sec	0.04	0.05	0.05
Closing time	sec	0.06	0.08	0.08
Weight of grippers	g	36	45	60
Moment of inertia	kg cm <sup>2</sup>	0.04	0.12	0.15
Repeatability	mm	0.1	0.1	0.1

## GRIPPERS WITH 3 PARALLEL JAWS SERIES P11 - P12



TECHNICAL DATA		P12-40	P12-64	P12-80 STANDARD	P12-80 INCREASED FORCE	P12-100 STANDARD	P12-100 INCREASED FORCE
Operating pressure	bar			2 to 8			
	MPa			0.2 to 0.8			
Temperature range	psi			29 to 116			
	°C			-10 to +80			
Fluid		20 µm filtered air, lubricated or unlubricated. If lubricated air is used, lubrication must be continuous.					
Single jaw stroke	mm	2.5	6	8	4	10	5
Clamping force of a single jaw at 6.3 bar, 20 mm from the upper surface, on opening and closing	N	130	310	435	860	840	1450
Maximum movable weight	kg	1.3	2.9	4.5	9	9	20
Minimum opening/closing time	s			0.05			
Repeatability	mm			0.01			
Moment of inertia	kg cm <sup>2</sup>	2.1	6	6.5		19	
Max. admissible static loads:							
- Fa	N	250	1100	1500		2000	
- Mx	Nm	10	40	90		80	
- My	Nm	5	60	55		115	
- Mz	Nm	12	40	55		70	
Weight	kg	0.2	0.7	0.75		1.4	

### GRIPPERS WITH TWO PARALLEL JAWS

Code	Description
W155020001	Gripper with 2 parallel jaws P1-20
W1550320001	Gripper with 2 parallel jaws P1-32
W1570160200	Gripper with 2 parallel jaws P2-16
W1570200200	Gripper with 2 parallel jaws P2-20
W1570250200	Gripper with 2 parallel jaws P2-25
W1560400200	Gripper with 2 parallel jaws P3-40
W1560640200	Gripper with 2 parallel jaws P3-64
W1560640201	Gripper with 2 parallel jaws P3-64 for inductive sensors
W1560800200	Gripper with 2 parallel jaws P3-80
W1560800201	Gripper with 2 parallel jaws P3-80 for inductive sensors
W1560800220	Gripper with 2 parallel jaws P3-80 increased force
W1560800221	Gripper with 2 parallel jaws P3-80 increased force for inductive sensors
W1561000200	Gripper with 2 parallel jaws P3-100
W1561000201	Gripper with 2 parallel jaws P3-100 for inductive sensors
W1561000220	Gripper with 2 parallel jaws P3-100 increased force
W1561000221	Gripper with 2 parallel jaws P3-100 increased force for inductive sensors
W1580100200	Gripper with 2 long-stroke parallel jaws P4-10
W1580120200	Gripper with 2 long-stroke parallel jaws P4-12

Code	Description
W1580160200	Gripper with 2 long-stroke parallel jaws P4-16
W1580250200	Gripper with 2 long-stroke parallel jaws P4-25
W1580300200	Gripper with 2 long-stroke parallel jaws P4-30

### GRIPPER WITH THREE PARALLEL JAWS

Code	Description
W1560400300	Gripper with 3 parallel jaws P12-40
W1560640300	Gripper with 3 parallel jaws P12-64
W1560640301	Gripper with 3 parallel jaws P12-64 for inductive sensors
W1560800300	Gripper with 3 parallel jaws P12-80
W1560800301	Gripper with 3 parallel jaws P12-80 for inductive sensors
W1560800320	Gripper with 3 parallel jaws P12-80 increased force
W1560800321	Gripper with 3 parallel jaws P12-80 increased force for inductive sensors
W1561000300	Gripper with 3 parallel jaws P12-100
W1561000301	Gripper with 3 parallel jaws P12-100 for inductive sensors
W1561000320	Gripper with 3 parallel jaws P12-100 increased force
W1561000321	Gripper with 3 parallel jaws P12-100 increased force for inductive sensors

### GRIPPERS WITH TWO HINGED JAWS

Code	Description
W1590160200	Gripper with 2 hinged jaws P7-16
W1590200200	Gripper with 2 hinged jaws P7-20
W1590320200	Gripper with 2 hinged jaws P7-32
W1590500200	Gripper with 2 hinged jaws P7-50
W0710010002	Tecnopolimer hinged grippers P8-32
W0710010003	Tecnopolimer hinged grippers P8-40
W0710010004	Tecnopolimer hinged grippers P8-50
W1530320180	Hinged gripper P9-32
W1530400180	Hinged gripper P9-40

## ACCESSORIES FOR P3-P12

Code	Size	Description
W1560409201	40	Kit of centring rings
W1560649201	64	Kit of centring rings
W1560809201	80	Kit of centring rings
W1561009201	100	Kit of centring rings

Note: 2-pieces pack

## ROTARY ACTUATORS SERIES R1

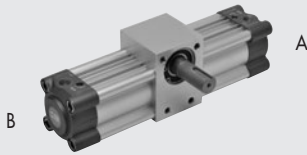

TECHNICAL DATA		32	40	50	63	80	100
Gaskets		NBR					
Operating pressure	bar	10					
	MPa	1					
	psi	145					
Temperature range	°C	- 10 to + 80					
Fluid		Filtered lubricated or unlubricated air. Lubrication, if used, must be continuous.					
Bores	mm	Ø 32 ; Ø 40 ; Ø 50 ; Ø 63 ; Ø 80 ; Ø 100					
Rotation angle		90°; 180°; 270°; 360°					
Type of construction		Extruded profile					
Configuration		Magnetic standard cushioned					
Axial load	N	2500	2800	4500	5600	8500	12200
Max. moment (6 bar - 0.6 MPa)	Nm	4.5	12.5	16	32	70	120
Weight	Kg	1.18 - 1.84	1.74 - 2.56	2.63 - 4.13	3.75 - 5.67	7.76 - 11.60	11.13 - 16.90

**N.B.** The product is supplied with negative end-of-stroke piston (in the proximity of head A).  
The first cycle involves movement of the piston (towards head B) with consequent anti-clockwise rotation of the pinion.

### ACTUAL ROTATION ANGLE

Actuators without regulation of the rotation angle: the manufactural tolerance is + 4°/0° compared to the nominal value  
Actuators with regulation of the rotation angle: the possible regulation ranges from + 2°/- 20°.

### KEY TO CODES

W165 TYPE		050 BORES	1 VERSION	090 ANGLE OF ROTATION •
W165	Rotary actuator with male pinion	032	1	090
W166	Rotary actuator with female pinion	040	2	180
		050		270
		063		360
		080		
		100		

• expressed in sexagesimal degrees.

## ROTARY ACTUATORS SERIES R2



TECHNICAL DATA		R2-12	R2-16	R2-20	R2-25
Operating pressure	bar	1.5 to 7			
	MPa	0.15 to 0.7			
	psi	22 to 101			
Temperature range	°C	-10 to +80			
Angle adjustment	degrees	35° (about +10° -25°)			
Fluid		20 µm filtered, lubricated or unlubricated air; lubrication if used, it must be continuous			
Versions		90°/180° rotation			
Ports		Both at the front			
Sizes	mm	12	16	20	25
Theoretical torque (P= pressure in bar)	Nm	0.065 x P	0.11 x P	0.21 x P	0.48 x P
Max. axial load	N	8	14	40	80
Max. radial load	N	8	14	40	80
Weight with 90° rotation	kg	0.18	0.26	0.63	0.8
Weight with 180° rotation	kg	0.21	0.31	0.72	1
Rotation time without load:					
• 90° angle	s	0.2	0.2	0.2	0.2
• 180° angle	s	0.3	0.3	0.3	0.3

### ROTARY ACTUATORS R2-12 90°/180°

Code	Description
W1620122090	Rotary actuator with shaft R2-12-90°
W1620122180	Rotary actuator with shaft R2-12-180°

### ROTARY ACTUATORS R2-16 90°/180°

Code	Description
W1620162090	Rotary actuator with shaft R2-16-90°
W1620162180	Rotary actuator with shaft R2-16-180°

### ROTARY ACTUATORS R2-20 90°/180°

Code	Description
W1620202090	Rotary actuator with shaft R2-20-90°
W1620202180	Rotary actuator with shaft R2-20-180°

### ROTARY ACTUATORS R2-25 90°/180°

Code	Description
W1620252090	Rotary actuator with shaft R2-25-90°
W1620252180	Rotary actuator with shaft R2-25-180°

## ROTARY ACTUATORS SERIES R3



TECHNICAL DATA		R3-16	R3-20	R3-22	R3-25	R3-30	R3-40
Operating pressure	bar				3 to 7		
	MPa				0.3 to 0.7		
	psi				43.5 to 101		
Temperature range	°C				-10 to +80		
Angle adjustment	degrees				0° to 180°		
Fluid		20 µm filtered, lubricated or unlubricated air; lubrication if used, it must be continuous					
Versions		With mechanical stop / hydraulic decelerator					
Sizes		16	20	22	25	30	40
Bores	mm	2 x 16	2 x 20	2 x 22	2 x 25	2 x 30	2 x 40
Theoretical torque at 6 bar	Nm	0.9	1.8	2.7	4.6	9.3	22
Max. axial load	N	74	135	195	300	340	360
Max. radial load	N	78	137	360	450	490	560
Weight	kg	0.53	0.99	1.29	2.08	3.9	6.7
Rotation time without load	s	0.2	0.2	0.2	0.2	0.3	0.3
Admissible kinetic energy	Joule						
WITH MECHANICAL STOP		0.007	0.025	0.049	0.082	0.090	0.150
(with flange W1630__2180 and with shaft W1630__5180)							
WITH HYDRAULIC DECELERATOR		-	-	-	0.29	1.10	1.60
(with flange W1630__2180 and with shaft W1630__5180)							

Code	Description
W1630162180	Rotary actuator with flange R3-16
W1630165180	Rotary actuator with shaft R3-16
W1630202180	Rotary actuator with flange R3-20
W1630205180	Rotary actuator with shaft R3-20
W1630222180	Rotary actuator with flange R3-22
W1630252180	Rotary actuator with flange R3-25
W1630253180	Rotary actuator with flange + shock absorbers R3-25
W1630255180	Rotary actuator with shaft R3-25
W1630256180	Rotary actuator with shaft + shock absorbers R3-25
W1630302180	Rotary actuator with flange R3-30
W1630303180	Rotary actuator with flange + shock absorbers R3-30
W1630305180	Rotary actuator with shaft R3-30
W1630306180	Rotary actuator with shaft + shock absorbers R3-30
W1630402180	Rotary actuator with flange R3-40
W1630403180	Rotary actuator with flange + shock absorbers R3-40

### ACCESSORIES

#### LTS POSITION SENSOR

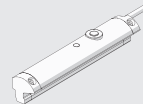

For technical data and usage strokes see page 84.

### SPARE PARTS

#### SHOCK ABSORBERS



Code	Ø	Description
0950004015	25	ECO S 25 MC2 short M14 x 1.5
0950004008	30	ECO 25 MC4 M14 x 1.5
0950004005	40	ECO 50 MC2 + nut M20 x 1.5

## ROTARY ACTUATORS SERIES R3 WITH EXTERNAL SHOCK ABSORBERS



TECHNICAL DATA		R3-16	R3-20	R3-22	R3-25	R3-30	R3-40
Operating pressure	bar				3 to 7		
	MPa				0.3 to 0.7		
	psi				43.5 to 101		
Temperature range	°C				-10 to +80		
Angle adjustment	degrees				90° o 180° ± 3°		
Fluid		20 µm filtered, lubricated or unlubricated air; lubrication if used, it must be continuous					
Sizes	mm	16	20	22	25	30	40
Bore	mm	2 x 16	2 x 20	2 x 22	2 x 25	2 x 30	2 x 40
Theoretical torque at 6 bar	Nm	0.9	1.8	2.7	4.6	9.3	22
Max. axial load	N	74	135	195	300	340	360
Max. radial load	N	78	137	360	450	490	560
Max overturning moment	Nm	2.4	4	5.3	9.7	12	18
Admissible kinetic energy	J	0.16	0.55	0.85	1.40	1.85	3.35
Rotation time without load	s	0.2	0.2	0.2	0.2	0.3	0.3

Code	Description
W1630164090	Rotary actuator with flange + shock absorbers R3-16-90
W1630164180	Rotary actuator with flange + shock absorbers R3-16-180
W1630204090	Rotary actuator with flange + shock absorbers R3-20-90
W1630204180	Rotary actuator with flange + shock absorbers R3-20-180
W1630224090	Rotary actuator with flange + shock absorbers R3-22-90
W1630224180	Rotary actuator with flange + shock absorbers R3-22-180
W1630254090	Rotary actuator with flange + shock absorbers R3-25-90
W1630254180	Rotary actuator with flange + shock absorbers R3-25-180
W1630304090	Rotary actuator with flange + shock absorbers R3-30-90
W1630304180	Rotary actuator with flange + shock absorbers R3-30-180
W1630404090	Rotary actuator with flange + shock absorbers R3-40-90
W1630404180	Rotary actuator with flange + shock absorbers R3-40-180

### ACCESSORIES

#### LTS POSITION SENSOR

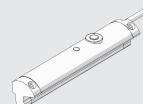

For technical data and usage strokes see page 84.

### SPARE PARTS

#### SHOCK ABSORBERS



Code	Ø	Description
0950004009	16	Shock absorbers ECO 10 MF3 M10 x 1
0950004010	22	Shock absorbers ECO 15 MF4 M12 x 1
0950004015	25-30	Shock absorbers ECO 25 MC2 M14 x 1.5
0950004005	40	Shock absorbers ECO 50 MC2 + nut M20 x 1.5

## TWIN CYLINDER SERIES S10



ACTUATORS

SLIDES

TECHNICAL DATA		S10-12	S10-16	S10-20	S10-25	S10-30
Pressure range	bar					3 to 7
	MPa					0.3 to 0.7
Temperature range	psi					43.5 to 101
	°C					-10 to +80
Fluid		20 µm dried or lubricated filtered air. Lubrication, if used, must be continuous.				
Piston speed	mm/s	30 to 100				
Versions		System with sliding bushes/System with ball bushes available with stop screw or hydraulic decelerator				
Sizes		12	16	20	25	30
Bores	mm	2 x 12	2 x 16	2 x 20	2 x 25	2 x 30
Piston rod diameter	mm	6	8	10	12	16
Strokes	mm	15	15	25	25	25
	mm	25	25	50	50	50
	mm	50	50	75	75	75
	mm	-	75	100	100	100
	mm	-	-	-	125	125
Weight (C = stroke mm)						
• Bushes version	kg	0.12 + (0.002 x C)	0.24 + (0.0025 x C)	0.51 + (0.005 x C)	0.76 + (0.006 x C)	1.3 + (0.009 x C)
• Ball bearing version	kg	0.21 + (0.002 x C)	0.48 + (0.0025 x C)	0.77 + (0.005 x C)	0.18 + (0.006 x C)	1.92 + (0.009 x C)
Theoretical thrust (P = relative pressure in bar)		(Multiply the value shown by the pressure in bar)				
• Thrust force	da N	2.26 x P	4 x P	6.28 x P	9.8 x P	14.1 x P
• Pull force	da N	1.69 x P	3 x P	4.11 x P	7.5 x P	10.1 x P
Max. loads		(The values shown refer to the min. and max. strokes)				
• Bushes version	N	6 to 4	11 to 6	20 to 7	26 to 8	36 to 11
• Ball bearing version	N	3 to 1.5	6 to 3	10 to 3.5	12 to 5.6	20 to 7

### ON BUSHES Ø 12 to 30 mm

Code	Ø	Code	Ø	Code	Ø
W1440122...	12	W1440202...	20	W1440302...	30
W1440162...	16	W1440252...	25		

### ON BALL BEARINGS Ø 12 to 30 mm

Code	Ø	Code	Ø	Code	Ø
W1440123...	12	W1440203...	20	W1440303...	30
W1440163...	16	W1440253...	25		

Note: To complete the code, add the 3-digit stroke (e.g. 50=050)

## TWIN CYLINDER SLIDE WITH FIXED BODY SERIES S11



TECHNICAL DATA		S11-12	S11-16	S11-20	S11-25	S11-30
Fluid		20 µm filtered air				
Pressure range	bar	1.5 to 7				
	MPa	0.15 to 0.7				
Temperature range	psi	43.5 to 101				
	°C	-10 to +80				
Piston speed	mm/s	30 to 200				
Versions		With sliding bushes / With ball bearing bushes / With stop screw / With hydraulic shock absorbers				
Bores	mm	12	16	20	25	30
Piston rod diameter	mm	6	8	10	12	16
Strokes	mm	25	25	25	25	25
	mm	50	50	50	50	50
	mm	75	75	75	75	75
	mm	-	100	100	100	100
	mm	-	-	125	125	125
	mm	-	-	-	150	150
Weight = X + (Y · C) where C = stroke	kg					
• Bushes version		X = 0.14 Y = 0.002	X = 0.25 Y = 0.0035	X = 0.5 Y = 0.045	X = 0.7 Y = 0.007	X = 1.24 Y = 0.01
• Ball bearing version		X = 0.25 Y = 0.002	X = 0.37 Y = 0.0035	X = 0.78 Y = 0.045	X = 1.04 Y = 0.007	X = 1.98 Y = 0.01
Theoretical thrust (P = relative pressure in bar)	N	16.9 x P	30 x P	47 x P	75 x P	101 x P
Max. loads		(The values shown refer to the min. and max. strokes)				
• Bushes version	N	Fr: 13 to 5 Fp: 6 to 3	Fr: 35 to 6.5 Fp: 11 to 3	Fr: 58 to 7 Fp: 18 to 5	Fr: 80 to 8 Fp: 23 to 6	Fr: 130 to 18 Fp: 50 to 8
• Ball bearing version	N	Fr: 7 to 3 Fp: 4 to 1.5	Fr: 20 to 4 Fp: 4 to 1.5	Fr: 35 to 4.5 Fp: 12 to 3	Fr: 50 to 5.4 Fp: 15 to 3.5	Fr: 80 to 12 Fp: 20 to 4.5

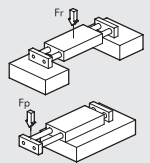

### ON BUSHES Ø 12 to 30 mm

Code	Ø	Code	Ø
W1450122...	12	W1450123...	12
W1450162...	16	W1450163...	16
W1450202...	20	W1450203...	20
W1450252...	25	W1450253...	25
W1450302...	30	W1450303...	30

### ON BALL BEARINGS Ø 12 to 30 mm

Code	Ø	Code	Ø
W1450123...	12	W1450124...	12
W1450163...	16	W1450164...	16
W1450203...	20	W1450204...	20
W1450253...	25	W1450254...	25
W1450303...	30	W1450304...	30

### ON BUSHES WITH SHOCK ABSORBERS - Ø 12 to 30 mm

Code	Ø	Code	Ø
W1450124...	12	W1450125...	12
W1450164...	16	W1450165...	16
W1450204...	20	W1450205...	20
W1450254...	25	W1450255...	25
W1450304...	30	W1450305...	30

### ON BALL BEARINGS WITH SHOCK ABSORBERS - Ø 12 to 30 mm

Code	Ø	Description
0950004001	12	Shock absorbers ECO 8 MC2 + nut M8x1
0950004002	16-20	Shock absorbers ECO 10 MF2 + nut M10x1
0950004003	25	Shock absorbers ECO 15 MF1 + nut M12x1
0950004004	30	Shock absorbers ECO 25 MC2 + nut M14x1.5

## SPARE PARTS

### SHOCK ABSORBERS



Note: To complete the code, add the 3-digit stroke (e.g. 50=050)



## TWIN CYLINDER SLIDE WITH FIXED PLATES SERIES S12



TECHNICAL DATA		S12-16	S12-20	S12-25	S12-30
Fluid		20 µm filtered air			
Pressure range	bar	1.5 to 7			
	MPa	0.15 to 0.7			
	psi	21.5 to 101			
Temperature range	°C	-10 to +80			
	mm/s	30 to 200			
Versions		With sliding bushes / With ball bearing bushes / With stop screw / With hydraulic shock absorbers			
Bores	mm	16	20	25	30
Piston rod diameter	mm	8	10	12	16
Strokes	mm	25	25	25	25
		50	50	50	50
		75	75	75	75
		100	100	100	100
		-	125	125	125
Weight = X + (Y · C) where C = stroke	kg			150	150
		X = 0.25 Y = 0.0035	X = 0.5 Y = 0.045	X = 0.7 Y = 0.007	X = 1.24 Y = 0.01
• Bushes version		X = 0.37 Y = 0.0035	X = 0.78 Y = 0.045	X = 1.04 Y = 0.007	X = 1.98 Y = 0.01
• Ball bearing version		30 x P	47 x P	75 x P	101 x P
Theoretical thrust (P = relative pressure in bar)	N	(The values shown refer to the min. and max. strokes)			
Max. loads	N	Fr: 35 to 6.5 Fp: 11 to 3	Fr: 58 to 7 Fp: 18 to 5	Fr: 80 to 8 Fp: 23 to 6	Fr: 130 to 18 Fp: 50 to 8
	N	Fr: 20 to 4 Fp: 4 to 1.5	Fr: 35 to 4.5 Fp: 12 to 3	Fr: 50 to 5.4 Fp: 15 to 3.5	Fr: 80 to 12 Fp: 20 to 4.5

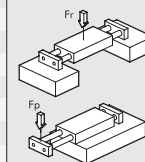

### ON BUSHES Ø 16 to 30 mm

Code	Ø
W1460162...	16
W1460202...	20
W1460252...	25
W1460302...	30

### ON BALL BEARINGS Ø 16 to 30 mm

Code	Ø
W1460163...	16
W1460203...	20
W1460253...	25
W1460303...	30

### ON BUSHES WITH SHOCK ABSORBERS - Ø 16 to 30 mm

Code	Ø
W1460164...	16
W1460204...	20
W1460254...	25
W1460304...	30

### ON BALL BEARINGS WITH SHOCK ABSORBERS - Ø 16 to 30 mm

Code	Ø
W1460165...	16
W1460205...	20
W1460255...	25
W1460305...	30

## SPARE PARTS

### SHOCK ABSORBERS



Code	Ø	Description
0950004002	16-20	Shock absorbers ECO 10 MF2 + nut M10 x 1
0950004003	25	Shock absorbers ECO 15 MF1 + nut M12 x 1
0950004004	30	Shock absorbers ECO 25 MC2 + nut M12 x 1.5

Note: To complete the code, add the 3-digit stroke (e.g. 50=050)

## PRECISION SLIDES SERIES S13



TECHNICAL DATA		Ø 6	Ø 10	Ø 16	Ø 20
Operating pressure	bar	2 to 8			
	MPa	0.2 to 0.8			
	psi	29 to 116			
Operating temperature	°C	-10 to +80			
	Fluid	Lubricated and unlubricated compressed air at 20 µm, must be uninterrupted when lubricated			
Minimum and maximum speed	mm/s	30 to 500			
Pneumatic fittings		M5			
Type of guide		Ball recirculation			
Versions		Magnetic dual-acting with rubber buffer			
Strokes	mm	10	10	10	10
		25	25	25	25
		---	---	50	50
Theoretical thrust force, at 6 bar	N	17	47	120	188
Theoretical pull force, at 6 bar	N	13	40	104	158
Admitted kinetic energy	Joule	0.012	0.025	0.050	0.100
Stroke tolerance	mm	0 / +1.0			
Assembly position		Any (horizontal and vertical)			

Code	Ø	Code	Ø
W1471063...	6	W1471163...	16
W1471103...	10	W1471203...	20

Note: To complete the code, add the 3-digit stroke (e.g. 50=050)

## FIXING ELEMENT

### K FIXING ELEMENT

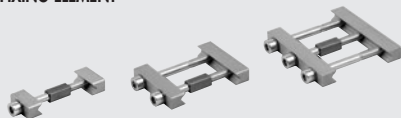

Code	Description
W0950005051K	Fixing element with one screw
W0950005052K	Fixing element with two screws
W0950005053K	Fixing element with three screws

### FIXING ELEMENT QS HEIGHT 8 mm



Code	Description
W0950005000K	Fixing element QS 12-8 (SLL-12-40)
W0950005001K	Fixing element QS 20-8 (SLL-20-40)
W0950005003K	Fixing element QS 55-8 (SLL-55-40)

### FIXING ELEMENT QS HEIGHT 22 mm



Code	Description
W0950005002K	Fixing element QS 20-22 (SLL-20/22-40)
W0950005004K	Fixing element QS 55-22 (SLL-55/22-40)

### FIXING BRACKETS FOR PROFILES



Code	Description
W0950005811K	EV-2-40 fixing bracket
W0950005812K	EV-3-40 fixing bracket
W0950005813K	EV-4-40 fixing bracket

### FRONT ADAPTER FOR LIGHTWEIGHT PROFILE PROFILE



Code	Description
W0950005816K	Front adapter SA-58-40

## PROFILES

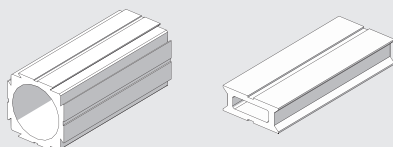

Code	Description
W0950005800K	TP-66-40-3M supporting profile
W0950005801K	LP-66-40-3M lightweight profile
W0950005802K	TP-16-40-2M supporting profile
W0950005803K	AP-56-40-2M adapter profile
W0950005804K	KFM-40-2M cable carrier profile
W0950005810K	AK-66-40 plastic cap
W0950005814K	GFTP-66-40 articulated foot
W0950005815K	GFLP-66-40 articulated foot

## ADAPTOR V-Lock

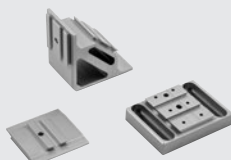

Code	Description
W0950005100K	2-1 parallel adaptor
W0950005110K	2-2 cross adaptor
W0950005120K	2-1 cross adaptor
W0950005200K	Longitudinal bracket
W0950005201K	Transversal bracket
W0950005202K	Cross bracket
0950008001K	Longitudinal adaptor
0950008002K	Transversal adaptor

### V-LOCK TRANSFORMER

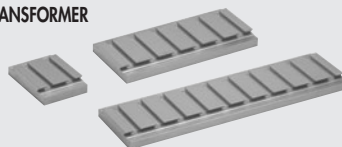

Code	Description
0950008012K	2-GROOVE V-Lock TRANSFORMER
0950008016K	6-GROOVE V-Lock TRANSFORMER
0950008020K	10-GROOVE V-Lock TRANSFORMER

### QS TRANSFORMER

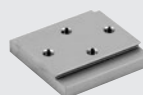

Code	Description
0950008050K	QS TRANSFORMER L = 55

## ACCESSORIES

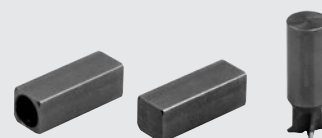

Code	Description
W0950005150K	V-Lock hollow key kit
W0950005151K	V-Lock key kit
9000770	Tool for V-Lock profile

## SPARE PARTS

Code	Description
W0950005170K	K screw kit
W0950005171K	QS screw kit

## RODLESS CYLINDERS V-Lock SERIES



TECHNICAL DATA	
Operating pressure	bar MPa psi
Temperature range	°C °F
Fluid	If unlubricated 50 µm unfiltered air is used, lubrication must be deactivated
Bore	mm
Design	Double-acting rodless cylinder with direct transmission system
Strokes	mm
Threaded ports	M5, 1/8", 1/4"
Fixing position	Free
Max. speed with or without shock absorbers	m/s
Notes	<p>For speeds lower than 0,2 m/s, to prevent bounce, use the No stick-slip version with unlubricated.</p> <p>When operating conditions exceed the values shown in the "Diagram of speed and maximum cushionable load", it is advisable to use the version with external shock absorbers.</p> <p>Every 2000 km or once a year (grease code 9910506)</p>
Lubrication	

### KEY TO CODE

CYL	2 7	5	0	3 2	0 1 0 0	C	N	K
	TYPE			BORE	STROKE		GASKETS	FAMILY
	27 Rodless cylinder	5 Dual-acting, cushioned, magnetic, with ball recirculation guides ▲ 6 Dual-acting, cushioned, with ball recirculation guides + adjustable stops and decelerators	0 Magnetic S Non-magnetic ■ G No stick-slip	16 25 32	Ø 16: 100 to 1350 mm Ø 25 - 32: 100 to 2300 mm		N NBR gaskets	K V-Lock

■ Use at speeds lower than 0.2 m/s to prevent bounce. Use unlubricated air only.

▲ For use in conditions exceeding those shown in the "Diagram of speed and maximum cushionable load" on general catalogue.

## ACCESSORIES

FOOT		ADJUSTABLE LIMIT SWITCH AND SHOCK ABSORBERS KIT		SHOCK ABSORBERS		
Ø 16	Ø 25	Ø 16	Ø 25	Ø 32		
<b>Code</b>	<b>Description</b>	<b>Code</b>	<b>Description</b>		<b>Code</b>	<b>Description</b>
W0950167001K	Foot D.016 V-Lock	0950164002K	Rodless cylinder limit switch and shock absorbers Ø 16 V-Lock		0950004003	Shock absorbers ECO 15 MF1 + nut M12x1
W0950257001K	Foot D.025 V-Lock	0950254002K	Rodless cylinder limit switch and shock absorbers Ø 25 V-Lock		0950004004	Shock absorbers ECO 25 MC2 + nut M14x1.5
W0950327001K	Foot D.032 V-Lock	0950324002K	Rodless cylinder limit switch and shock absorbers Ø 32 V-Lock		0950004005	Shock absorbers ECO 50 MC2 + nut M20x1.5
INTERMEDIATE SUPPORT		SENSOR SUPPORT		SPARE		
Ø 16	Ø 25					
<b>Code</b>	<b>Description</b>	<b>Code</b>	<b>Description</b>			
W0950164004K	Intermediate support D.016 V-Lock	0950164003	Sensor support short 016			
W0950254004K	Intermediate support D.025 V-Lock	0950164001	Sensor support std 016			
W0950324004K	Intermediate support D.032 V-Lock					

See page 27 (pour diamètres 16-25-32)

## COMPACT PRECISION SLIDES SERIES S14K

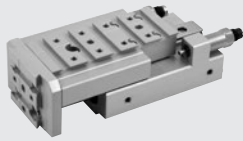

ACTUATORS

V-Lock

TECHNICAL DATA		S14K-8	S14K-16	S14K-25
Operating pressure	bar		2 to 8	
	psi		29 to 116	
Temperature range	°C		-10 to +80	
Fluid		Dry or lubricated 10 µm filtered compressed air. Lubrication, if used, must be continuous.		
Maximum speed	m/s	0.8 we always suggest to use flow microregulators	0.8	0.8
Versions		With shock absorbers - With elastic mechanical stop		
Bore	mm	2 x Ø 8	2 x Ø 16	2 x Ø 25
Piston rod diameter	mm	4	8	12
Strokes	mm	10, 20, 30, 40, 50, 80, 100	10, 20, 30, 40, 50, 80, 100, 125, 150	10, 20, 30, 40, 50, 80, 100, 125, 150, 200
Stroke reduction by adjusting the decelerators retraction	mm	16 extension / 16 retraction	12 extension / 12 retraction	30 extension / 30 retraction
Stroke reduction by adjusting the buffers retraction	mm	8 extension / 8 retraction	10 extension / 10 retraction	15 extension / 15 retraction
Maximum impact energy with hydraulic decelerators	J	2	5	20
Maximum impact energy with buffers	J	0.15	0.25	0.5
Sensors		Sensors Magnetic Hall or Reed		
Theoretical thrust force at 6 bar	N	60	240	589
Theoretical pull force at 6 bar	N	46	180	453
Repeatability in stop positions	mm	0.02 (with shock absorbers); 0.02 (with buffers and 5 bar minimum pressure)		
Monitoring position		Any		
Notes		Lubrication recommended: every 2 million cycles for strokes below 100 mm and 1 million for longer strokes (grease code 9910506)		

### KEY TO CODES

W147 TYPE	2 MODEL	08 BORE	3 STOP	050 STROKE	020	K FAMILY
Precision slide	2 S14K	08 16 25	3 With mechanical stop 5 With shock absorbers	See general technical data	Only for version with third-position stop device	K V-Lock

### ACCESSORIES

#### GREASE

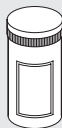

Code	Description
9910506	Tube of RHEOLUBE 363 AX1 grease

### SPARE PARTS

#### GASKET SPARE PARTS KIT

Code	Description
W1472089001K	S14K gasket kit Ø 8
W1472169001K	S14K gasket kit Ø 16
W1472259001K	S14K gasket kit Ø 25

#### SHOCK ABSORBERS



Code	Description
W0950005300	Shock absorbers - 2 M8 x 1
W0950005301	Shock absorbers - 2 M10 x 1
W0950005303	Shock absorbers - 2 M14 x 1.5

#### ELASTIC MECHANICAL STOP



Code	Description
W0950005400K	Elastic mechanical stop M8 x 1
W0950005401K	Elastic mechanical stop M10 x 1 + nut
W0950005402K	Elastic mechanical stop M14 x 1.5 + bushing

## GUIDE UNITS SERIES GDHK AND GDMK

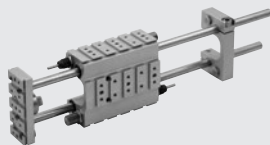

TECHNICAL DATA		Ø 12	Ø 16	Ø 20	Ø 25	Ø 32	Ø 40
Strokes	mm	From 1 to 600					
Stroke reduction via stop adjustment	mm	The total stroke can be shortened using adjusting stops and/or the rear plate.					
Temperature range	°C	-14 per side		-22 per side		-40 per side	-35 per side
Recommended maximum speed	m/s	-10 to +80					
Rear plate torques	Nm	1					
Guide column diameter	mm	7 ±1		22 ±2			35 ±2
Maximum impact energy with shock absorbers	Ec [J]	10		12		16	20
with buffers	Ec [J]	5		20		25	70
without stops		0.5		1		2	2
Repeatability (at 6 bar)		See general catalogue					
Versions with buffers	mm	±0.02 (with minimum pressure 5 bar)					
Versions with shock absorbers	mm	±0.02					
Lubrication		<p>The guides are supplied lubricated. There are two greasers on the guide bodies (one per column) for periodic lubrication using a pump with a nozzle.</p> <p>The following greases are recommended:</p> <ul style="list-style-type: none"> <li>- version GDHK: code 9910502 (RHEOLUBE 362 HB)</li> <li>- version GDMK: code 9910506 (RHEOLUBE 363AX1)</li> </ul> <p>The lubrication interval depends on numerous factors such as load, temperature, speed, stroke, lubricant, environmental conditions and assembly position.</p> <p><b>As a general rule, lubrication is recommended every 500.000 – 1.000.000 cycles.</b></p>					

### KEY TO CODES

W070 TYPE	012 BORE	2 VERSION	050 STROKE	00 EXECUTION	K FAMILY
Guide unit	012 12 012 16 020 20 025 25 032 32 040 40	2 Version H 3 Version M	See general technical data	00 Without stop 01 With front stop and buffers 02 With front stop and shock absorber 03 With front and rear stops and buffers 04 With front and rear stops and shock absorbers ■ 05 With short columns for Elektro cylinder	K V-Lock

■ For Ø 32 only

## ACCESSORIES AND SPARE PARTS

### ELASTIC MECHANICAL STOP

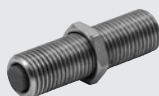

Code	Ø	Description
W0950005401K	12-16	Elastic mechanical stop M10x1 + nut
W0950005402K	20-25	Elastic mechanical stop M14x1.5 + bushing
W0950005403K	32	Elastic mechanical stop M20x1.5 + nut
W0950005404K	40	Elastic mechanical stop M25x1.5 + nut

### MECHANICAL STOPS

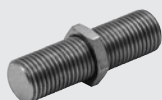

Code	Ø	Description
W0950005501K	12-16	Mechanical stop M10x1 + nut
W0950005502K	20-25	Mechanical stop M14x1.5 + nut
W0950005503K	32	Mechanical stop M20x1.5 + nut
W0950005504K	40	Mechanical stop M25x1.5 + nut

### SHOCK ABSORBERS



Code	Ø	Description
W0950005301	12-16	Shock absorbers 2 M10x1 + nut
0950004004	20-25	Shock absorbers ECO25 MC2 + nut M14x1.5
0950004005	32	Shock absorbers ECO50 MC2 + nut M20x1.5
0950004006	40	Shock absorbers ECO100 MF2 + nut M25x1.5

### REAR PLATE KITS



Code	Ø	Description
W0950005600K	12-16	Rear plate kit GD_K
W0950005601K	20-25	Rear plate kit GD_K
W0950005602K	32	Rear plate kit GD_K
W0950005603K	40	Rear plate kit GD_K

Note: individually packed with 2 screws

### GREASE



Code	Description	Weight [g]
9910502	Tube of RHEOLUBE 362 grease (for GDHK version)	1000
9910506	Tube of RHEOLUBE 363 AX1 grease (for GDMK version)	400

## LINEAR UNITS SERIES LEPK



ACTUATORS

V-Lock

TECHNICAL DATA	LEPK-1-90-H		LEPK-1-160-H		LEPK-1-225-H		LEPK-2-320-H		LEPK-2-450-H		LEPK-1-60-V		LEPK-1-90-V		LEPK-1-160-V			
	Type A	Type B	Type A	Type B	Type A	Type B	Type A	Type B	Type A	Type B	Type A	Type B	Type A	Type B	Type A	Type B		
Number of positions	2	3	2	3	2	3	2	3	2	3	2	3	2	3	2	3		
Orientation	Horizontal										Vertical							
Operating pressure	bar						3 to 7						MPa					
							0.3 to 0.7						psi					
							43.5 to 101						°C					
Temperature range							-10 to 50						°F					
							14 to 122											
Fluid	Lubricated or unlubricated 20 µm filtered air. If lubricated air is used, lubrication must be continuous.																	
End position stop shock-absorption	mm Hydraulic shock-absorbers																	
End-position control	Inductive sensors with a LED visible from the outside																	
Repeatability	mm < 0.005																	
(on 100 strokes at constant conditions)																		
Piston diameter / Piston rod diameter			16 / 6				20 / 8		25 / 10				16 / 6					
Stroke (min / max)	15 to 90		15 to 160		15 to 225		50 to 320		50 to 450		15 to 60		15 to 90		15 to 160			
Intermediate useful stroke	-   0 to 80		-   0 to 100		-   0 to 100		-   0 to 150		-   0 to 150		-   0 to 50		-   0 to 80		-   0 to 100			
Theoretic force at 6 bar:																		
in thrust	N		106		106		165		260		Max. 90 (see table on general catalogue)		Max. 150 (see table on general catalogue)					
in traction	N		90		90		137		218									
Weight	kg		2.5   3.1		3.2   3.8		4.5   4.6		8   9.6		10.5   11		2.15   2.5		2.35   3		3.1   3.7	
Weight of the moving mass	kg		0.68		0.83		1.25		2.29		3.12		0.61		0.68		0.83	
Maximum kinetic energy	J/stroke		5.88		5.88		19.6		53000		5.88		25000		5.88		25000	
	J/h		25000		25000		53000		53000		25000		25000		25000		25000	
Electrical protection class with PG29 pipe mounted (only for versions with a terminal board)	IP 42																	
Relative air humidity (only for versions with a terminal board)	< 95 %																	
Power connection cable (only for versions with a terminal board)	Max. 17 wires 0.14 - 0.5 mm <sup>2</sup> for max. 15 proximity switches +0 V +24 V																	
Pneumatic connection	Pipe Ø 4						Pipe Ø 6						Pipe Ø 4					
Speed control	Flow regulators Ø 4 - M5						Flow regulators Ø 6 - 1/8"						Flow regulators Ø 4 - M5					

**IMPORTANT:** for maximum forces and moments, see general catalogue.

### KEY TO CODES

K10	1	A	H	0	0	090	0	000	00	K
	SIZE	POSITION	ORIENTATION			STROKE	V-Lock CONNECTION	V-Lock POSITION	Number of V-Lock GROOVES	FAMILY
Linear units series LEPK	1 Size 1 2 Size 2	A 2 positions B 3 positions	H Horizontal V Vertical (with return spring) S Vertical (without return spring)	0 Inductive sensors (with terminal board) 2 Inductive sensors (without terminal board)		▼ 060 ◆ 090 ◆ 160 + 225 * 320 * 450	0 None B Grooves above and below D Grooves below U Grooves above	□ 000 None ▲ --- Position	□ 00 None ■ --- Number of grooves	K V-Lock

- ◀ Available only in horizontal orientation (H).
  - Standard for the version with vertical orientation (V).
  - ▼ Only size 1 - V/S
  - ◆ Only size 1 - V/S/H
  - + Only size 1 - H
  - \* Only size 2 - H
  - Always use when "V-Lock connection" is equal to "0" (none)
  - ▲ For connecting V-Lock "B" - "D" - "U" minimum value "025", the following values vary by steps of 20 mm (e.g. "045", "065" and "085").
- For mounting options, see general catalogue.

- The maximum number of possible grooves is:
  - LEPK 1-60-V/S-A = n. 08
  - LEPK 1-60-V/S-B = n. 10
  - LEPK 1-90-V/S-A = n. 10
  - LEPK 1-90-V/S-B = n. 13
  - LEPK 1-90-H-A = n. 10
  - LEPK 1-90-H-B = n. 13
  - LEPK 1-160-H-A = n. 13
  - LEPK 1-160-H-B = n. 17
  - LEPK 1-160-V/S-A = n. 13
  - LEPK 1-160-V/S-B = n. 17
  - LEPK 1-225-H-A = n. 23
  - LEPK 1-225-H-B = n. 23
  - LEPK 2-320-H-A = n. 24
  - LEPK 2-320-H-B = n. 29
  - LEPK 2-450-H-A = n. 35
  - LEPK 2-450-H-B = n. 35
- N.B. The number of Ø5 H7 pinholes always coincides with the number of grooves ordered less 1.
- For mounting options, see general catalogue.

## ACCESSORIES

OIL			CABLE GUIDE		
Code	Description	Volume [ml]	Code	Description	Length [mm]
9910490	PARALIQ P 460	80	095K2100850K	Cable guide LEPK-1-90-A/B 160-A	850
			095K2100900K	Cable guide LEPK-1-160-B	900
			095K2101200K	Cable guide LEPK-1-225-A/B	1200
			095K2101550K	Cable guide LEPK-2-320-A/B	1550
			095K2101700K	Cable guide LEPK-2-450-A/B	1700
			095K2102500K	Cable guide LEPK	2500



## COMPACT GUIDED CYLINDERS SERIES CMPGK

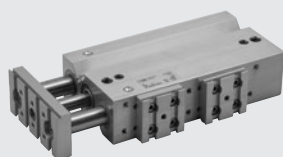

TECHNICAL DATA		CUSHIONED	NON-CUSHIONED
Operating pressure	bar MPa		1 to 10 0.1 to 1
	psi		14.5 to 145
Temperature range	°C °F		-10 to +80 14 to 176
Fluid		Filtered air without lubrication; lubrication, if used, must be continuous	
Bore	mm	16, 20, 25, 32, 40	
Standard stroke	mm	<b>Ø 16:</b> 20, 30, 40, 50 <b>Ø 20:</b> 20, 30, 40, 50, 75, 100, 150, 200 <b>Ø 25:</b> 20, 30, 40, 50, 75, 100, 150 <b>Ø 32:</b> 25, 50, 75, 100, 150, 175 <b>Ø 40:</b> 25*, 50, 75, 100, 150, 175	<b>Ø 16:</b> 30*, 40, 50, 75, 100, 150, 200 <b>Ø 20:</b> 25, 30, 40, 50, 75, 100, 150, 200 <b>Ø 25:</b> 25, 30, 40, 50, 75, 100, 150, 200 <b>Ø 32:</b> 25, 50, 75, 100, 150, 200 <b>Ø 40:</b> 50, 75, 100, 150, 200
Version		With bronze bushings - With ball bearings	
Sensor magnet		Standard	
Maximum impact energy	J	See general catalogue	<b>Ø 16:</b> 0.06 <b>Ø 20:</b> 0.14 <b>Ø 25:</b> 0.2 <b>Ø 32:</b> 0.4 <b>Ø 40:</b> 0.6
Notes		* Side and Down versions only	

### KEY TO CODES

CYL	W143 TYPE	032 DIAMETER	2 VERSION	050 STROKE	U FIXING SIDE	K FAMILY
	Compact guided cylinder	<b>016</b> Ø 16 <b>020</b> Ø 20 <b>025</b> Ø 25 <b>032</b> Ø 32 <b>040</b> Ø 40	<b>2</b> Non-cushioned with bronze bushings <b>3</b> Non-cushioned with ball bearings <b>4</b> Cushioned with bronze bushings <b>5</b> Cushioned with ball bearings	<b>CUSHIONED</b> <b>Ø 16:</b> 20, 30, 40, 50 <b>Ø 20:</b> 20, 30, 40, 50, 75, 100, 150, 200 <b>Ø 25:</b> 20, 30, 40, 50, 75, 100, 150 <b>Ø 32:</b> 25, 50, 75, 100, 150, 175 <b>Ø 40:</b> 25*, 50, 75, 100, 150, 175  <b>NON-CUSHIONED ♦</b> <b>Ø 16:</b> 30*, 40, 50, 75, 100, 150, 200 <b>Ø 20:</b> 25, 30, 40, 50, 75, 100, 150, 200 <b>Ø 25:</b> 25, 30, 40, 50, 75, 100, 150, 200 <b>Ø 32:</b> 25, 50, 75, 100, 150, 200 <b>Ø 40:</b> 50, 75, 100, 150, 200	<b>U</b> Up <b>S</b> Side <b>D</b> Down	<b>K</b> V-Lock

\* Side and Down versions only

♦ Other strokes on request but with the same cylinder dimensions as the standard stroke immediately above.

## ROTARY ACTUATOR SERIES R3K

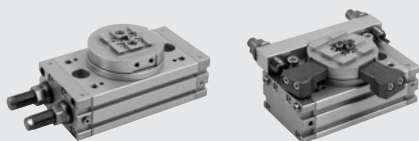

TECHNICAL DATA		R3K-16	R3K-20	R3K-25
Operating pressure	bar MPa		3 to 7 0.3 to 0.7	
	psi		43 to 101	
Temperature range	°C		-10 to 80	
Fluid		Lubricated or unlubricated 20 µm filtered air. If lubricated air is used, lubrication must be continuous.		
Bore	mm	2 x 16	2 x 20	2 x 25
Theoretical torque at 6 bar	Nm	0.9	1.8	4.6
Maximum axial load	N	74	135	300
Maximum radial load	N	78	137	450
Maximum overturning moment	Nm	2.4	4	9.7
Rotation time without load	s	0.2	0.2	0.2

### ROTARY ACTUATOR R3K

Code	Description
W1630162180K	Rotary actuator R3K-16-180
W1630202180K	Rotary actuator R3K-20-180
W1630252180K	Rotary actuator R3K-25-180
W1630253180K	Rotary actuator + shock absorbers R3K-25-180

### ROTARY ACTUATOR WITH EXTERNAL SHOCK ABSORBERS

Code	Description
W1630164090K	Rotary actuator with external shock absorbers R3K-16-90
W1630164180K	Rotary actuator with external shock absorbers R3K-16-180
W1630204090K	Rotary actuator with external shock absorbers R3K-20-90
W1630204180K	Rotary actuator with external shock absorbers R3K-20-180
W1630254090K	Rotary actuator with external shock absorbers R3K-25-90
W1630254180K	Rotary actuator with external shock absorbers R3K-25-180

### SPARE PARTS

See page 37

## ROTARY ACTUATOR SERIES DAPK



ACTUATORS

V-Lock

TECHNICAL DATA	DAPK-1	DAPIK-1	DAPK-2	DAPIK-2
Internal air flows	NO	YES	NO	YES
Operating pressure			2 to 7 0.2 to 0.7	
			29 to 101	
Temperature range			-10 to 80	
			14 to 176	
Fluid	Lubricated or unlubricated 20 µm filtered air. If lubricated air is used, lubrication must be continuous.			
End position stop shock-absorption	Hydraulic shock-absorbers or elastic mechanical stop.			
End-position control	Inductive sensors, magnetic sensors.			
Rotation angle	Adjustable from 0 to 180			
Bore	20			32
Moment of inertia around the central axis	0.004			0.030
Theoretical torque at 6 bar	1.1			3.8
Maximum overturning moment	5			15
Allowable axial tensile stress/compression	90 / 120			240 / 460
Allowable critical strain energy:				
with elastic mechanical stop	0.02			0.06
with shock absorbers	0.20			0.60
Repeatability (on 100 strokes at constant conditions)	≤ 0.01			≤ 0.01 - 0.02
Weight of the 2-position version	0.56	0.71	1.50	1.73
Weight of the 3-position version	0.66	0.80	1.67	1.90
Weight of the 4-position version	0.76	0.89	1.84	2.07

### KEY TO CODES

K20	1 SIZE	02 POSITION	0	3 END POSITION	0	00	K FAMILY
Rotary actuator series DAPK / DAPIK	1 Size 1 2 Size 2	02 2 position (DAPK) ▲ S3 3 position (DAPK + DZAK) ■ D3 3 position (DAPK + DZAK) 04 4 position (DAPK + n.2 DZAK)	0 Without internal air flow 1 With internal in-line air flow (DAPIK) 2 With 90° in-line air flow (DAPIK + WAK)	3 With elastic mechanical stop 5 With standard shock absorbers (STD) <b>On request</b> ● 6 With medium hardness shock-absorbers (H2) ● 7 With hard shock-absorbers (M7)	0 Magnetic S Non-magnetic		K V-Lock

▲ On the left viewed from the rotating plate.

■ On the right viewed from the rotating plate.

● Only for size 2.

## ACCESSORIES

### INTERMEDIATE STOP

Code	Description
095K2000100K	DZAK-1 intermediate stop
095K2000110K	DZAK-2 intermediate stop

### ADJUSTING WRENCH

Code	Description
095K2000250K	DZAK-1 adjusting wrench
095K2000260K	DZAK-2 adjusting wrench

### WAK

Code	Description
095K2000150K	WAK-1 angle adaptor
095K2000160K	WAK-2 angle adaptor

Note: Individually packed with 4 screws, 4 washers

### ELASTIC MECHANICAL STOP

Code	Description	For
095K2000200K	Elastic mechanical stop M14 x 1	DAPK-1/DAPIK-1
095K2000210K	Elastic mechanical stop M18 x 1	DAPK-2/DAPIK-2

### QUICK-FIT INDUCTIVE SENSOR Ø 6.5

Code	Description
W095K030009	PNP Ø 6.5 inductive sensor with push-in LED

### SHOCK ABSORBERS

Code	Description	For
W0950005301	Shock absorbers - 2 M10 x 1	DAPK-1/DAPIK-1
0950004012	Shock absorbers standard MC150EUMH M14 x 1.5	DAPK-2/DAPIK-2
0950004013	Medium hardness shock absorber MC150EUMH2 M14 x 1.5	DAPK-2/DAPIK-2
0950004014	Hard shock absorber SC190EUM7 M14 x 1.5	DAPK-2/DAPIK-2

### INDUCTION SENSOR Ø 6.5

Code	Description
W095K030006	PNP Ø 6.5 PNP inductive sensor with LED 2 m
W095K031006	NPN Ø 6.5 NPN inductive sensor with LED 2 m

### POSITION SENSOR

Code	Description	For
W0950000470	LTS-032 position sensor with M8 4-PIN 0.3 m connector	DAPK-1/DAPIK-1
W0950000471	LTS-064 position sensor with M8 4-PIN 0.3 m connector	DAPK-2/DAPIK-2

### OIL

Code	Description	Volume [ml]
9910490	PARALIQ P 460	80

### CABLE WITH STRAIGHT CONNECTOR FOR Ø 6.5 PUSH-IN INDUCTIVE SENSOR (MOBILE INSTALLATION)

Code	Description
02400A0100	M8 female 3 PIN HIGH FLEX CL6 connector with cable L = 1 m
02400A0250	M8 female 3 PIN HIGH FLEX CL6 connector with cable L = 2.5 m
02400A0500	M8 female 3 PIN HIGH FLEX CL6 connector with cable L = 5 m
02400A1000	M8 female 3 PIN HIGH FLEX CL6 connector with cable L = 10 m

Note: Mobile laying cable, class 6 according to IEC 60228

### CABLE WITH 90° CONNECTOR FOR Ø 6.5 PUSH-IN INDUCTIVE SENSOR (MOBILE INSTALLATION)

Code	Description
02400B0100	M8 female 3 PIN 90° HIGH FLEX CL6 connector with cable L = 1 m
02400B0250	M8 female 3 PIN 90° HIGH FLEX CL6 connector with cable L = 2.5 m
02400B0500	M8 female 3 PIN 90° HIGH FLEX CL6 connector with cable L = 5 m
02400B1000	M8 female 3 PIN 90° HIGH FLEX CL6 connector with cable L = 10 m

Note: Mobile laying cable, class 6 according to IEC 60228

## GRIPPERS



TECHNICAL DATA		P1K-20	P1K-32	P2K-20	P3K-64	P3K-80		P3K-100		P4K-12
						STANDARD	INCREASED FORCE	STANDARD	INCREASED FORCE	
Operating pressure	bar	2 to 8		2 to 8		2 to 8		2 to 8		3 to 8
	MPa	0.2 to 0.8		0.2 to 0.8		0.2 to 0.8		0.2 to 0.8		0.3 to 0.8
	psi	29 to 116		29 to 116		29 to 116		29 to 116		43 to 116
Temperature range	°C	5 to 70		-10 to 80		-10 to 80		-10 to 80		-10 to 80
Fluid		20 µm filtered air, lubricated or unlubricated. If lubricated air is used, lubrication must be continuous								
Bore	mm	20	32	20	-	-	-	-	-	2 x 12
Clamping force of a single jaw at 6.3 bar, 20 mm from the upper surface, on opening and closing	N	70	170	100	125	265	445	360	790	45
Stroke of each jaw	mm	5	5	5	6	8	4	10	5	10
Max. frequency on continuous operation	Hz	> 5	> 5	> 5	-	-	-	-	-	> 4
Minimum opening/closing time	s	0.009/0.016	0.02/0.02	0.012/0.02			0.05			0.008/0.008
Repeatability	mm	> 0.02	> 0.02	0.01			0.01			< 0.04
Lubrication		Grease the sliding surfaces of the jaws every one million cycles. Use grease code 9910509								
Max. admissible static loads:										
- Fa	N	200	350	450	1100	1500		2000		200
- Mx	Nm	6	10	12	40	90		80		6
- My	Nm	6	10	12	60	55		115		6
- Mz	Nm	8	12	16	40	55		70		8
Weight	kg	0.50	0.85	0.4	0.4	0.6		1		0.35

TECHNICAL DATA		P7K-20	P7K-32	P9K-32	P9K-40	P12K-64	P12K-80		P12K-100	
							STANDARD	INCREASED FORCE	STANDARD	INCREASED FORCE
Operating pressure	bar	2 to 10		2 to 8		2 to 8		2 to 8		
	MPa	0.2 to 1.0		0.2 to 0.8		0.2 to 0.8		0.2 to 0.8		
	psi	29 to 145		29 to 116		29 to 116		29 to 116		
Temperature range	°C	-10 to 80		-10 to 80		-10 to 80		-10 to 80		
Fluid		20 µm filtered air, lubricated or unlubricated. If lubricated air is used, lubrication must be continuous								
Bore	mm	20	32	32	40	-	-	-	-	-
Clamping force of a single jaw at 6.3 bar, 20 mm (40 mm for P9) from the upper surface, on opening and closing	N	50	120	160	260	310	435	860	840	1450
Stroke of each jaw	mm	-	-	-	-	6	8	4	10	5
Max. frequency on continuous operation	Hz	> 5	> 5	> 5	> 5	-	-	-	-	-
Minimum opening/closing time	s	0.042/0.016	0.017/0.010	0.034/0.041	0.052/0.061			0.05		
Repeatability	mm	0.01	0.01	< 0.02	< 0.02			0.01		
Lubrication		Grease the sliding surfaces of the jaws every one million cycles. Use grease code 9910509								
Max. admissible static loads:										
- Fa	N	200	350	350	500	1100	1500		2000	
- Mx	Nm	6	10	12	20	40	90		80	
- My	Nm	6	10	12	20	60	55		115	
- Mz	Nm	8	12	16	24	40	55		70	
Weight	kg	0.22	0.54	0.76	1.6	0.75	0.8		1.5	

TECHNICAL DATA		GPLK-1-30	GPLK-1-40	GPLK-2-45	GPLK-2-60	GPLK-2-75
Operating pressure	bar	2 to 8				
	MPa	0.2 to 0.8				
	psi	29 to 116				
Temperature range	°C	-10 to 80				
Fluid		20 µm filtered air, lubricated or unlubricated. If lubricated air is used, lubrication must be continuous				
Clamping force of a single jaw at 6.3 bar, 20 mm from the upper surface, on opening and closing	N	42		116		
Single jaw stroke, adjustable	mm	1 to 15	6 to 20	5.5 to 22.5	13 to 30	20 to 37.5
Maximum overall stroke	mm	30	40	45	60	75
Minimum opening/closing time measured at maximum stroke:						
at 3 bar	s	0.18	0.22	0.44	0.60	0.76
at 6 bar	s	0.10	0.12	0.28	0.32	0.36
Repeatability (on 100 strokes at constant conditions)	mm	< 0.03		< 0.04		
Moment of inertia around the y axis	kg.cm <sup>2</sup>	3.5	4.4	16.4	21.5	29.1
Weight	kg	0.44	0.46	1.04	1.12	1.26
Max. admissible static loads						
Ft	N	7.5		15		
Fa	N	70		120		
Mx	Nm	9		37		
My	Nm	4		23		
Mz	Nm	7		22		

### GRIPPERS WITH TWO PARALLEL JAWS

Code	Description
W1550200001K	Gripper with 2 parallel jaws <b>P1K-20</b>
W1550320001K	Gripper with 2 parallel jaws <b>P1K-32</b>
W1570200200K	Gripper with 2 parallel jaws <b>P2K-20</b>
W1560640200K	Gripper with 2 parallel jaws <b>P3K-64</b>
W1560640201K	Gripper with 2 parallel jaws <b>P3K-64</b> for inductive sensors
W1560800200K	Gripper with 2 parallel jaws <b>P3K-80</b>
W1560800201K	Gripper with 2 parallel jaws <b>P3K-80</b> for inductive sensors
W1560800220K	Gripper with 2 parallel jaws <b>P3K-80</b> increased force
W1560800221K	Gripper with 2 parallel jaws <b>P3K-80</b> increased force for inductive sensors
W1561000200K	Gripper with 2 parallel jaws <b>P3K-100</b>
W1561000201K	Gripper with 2 parallel jaws <b>P3K-100</b> for inductive sensors
W1561000220K	Gripper with 2 parallel jaws <b>P3K-100</b> increased force
W1561000221K	Gripper with 2 parallel jaws <b>P3K-100</b> increased force for inductive sensors
W1580120200K	Gripper with 2 parallel jaws, long stroke <b>P4K-12</b>
K3010300000K	Gripper with 2 parallel jaws, long stroke <b>GPLK-1-30</b>
K3010400000K	Gripper with 2 parallel jaws, long stroke <b>GPLK-1-40</b>
K3020450000K	Gripper with 2 parallel jaws, long stroke <b>GPLK-2-45</b>
K3020600000K	Gripper with 2 parallel jaws, long stroke <b>GPLK-2-60</b>
K3020750000K	Gripper with 2 parallel jaws, long stroke <b>GPLK-2-75</b>

### ACCESSORIES

#### ADAPTORS

Code	Description
0950008003K	Side adaptor kit type 1 for <b>P4K-12</b>
0950008004K	Side adaptor kit type 2 for <b>P1K, P2K, P7K, P9K-32, GPLK</b>
0950008005K	Side adaptor kit type 3 for <b>P9K-40</b>

#### GREASE

Code	Description	Weight [g]
9910509	Grease pipe NYOGEL 774 H	500

### ACCESSORIES FOR GPLK

#### INDUCTION SENSOR Ø 6.5

Code	Description
W095K030006	PNP Ø 6.5 PNP inductive sensor with LED 2 m
W095K031006	NPN Ø 6.5 NPN inductive sensor with LED 2 m

#### QUICK-FIT INDUCTIVE SENSOR Ø 6.5

Code	Description
W095K030009	PNP Ø 6.5 inductive sensor with push-in LED

#### OIL

Code	Description	Volume [ml]
9910490	PARALIQ P 460	80

#### NOTES

### GRIPPERS WITH TWO HINGED JAWS

Code	Description
W1590200200K	Gripper with 2 hinged jaws <b>P7K-20</b>
W1590320200K	Gripper with 2 hinged jaws <b>P7K-32</b>
W1530320180K	Gripper with 2 hinged jaws <b>P9K-32</b>
W1530400180K	Gripper with 2 hinged jaws <b>P9K-40</b>

### GRIPPER WITH THREE PARALLEL JAWS

Code	Description
W1560640300K	Gripper with 3 parallel jaws <b>P12K-64</b>
W1560640301K	Gripper with 3 parallel jaws <b>P12K-64</b> for inductive sensors
W1560800300K	Gripper with 3 parallel jaws <b>P12K-80</b>
W1560800301K	Gripper with 3 parallel jaws <b>P12K-80</b> for inductive sensors
W1560800320K	Gripper with 3 parallel jaws <b>P12K-80</b> increased force
W1560800321K	Gripper with 3 parallel jaws <b>P12K-80</b> increased force for inductive sensors
W1561000300K	Gripper with 3 parallel jaws <b>P12K-100</b>
W1561000301K	Gripper with 3 parallel jaws <b>P12K-100</b> for inductive sensors
W1561000320K	Gripper with 3 parallel jaws <b>P12K-100</b> increased force
W1561000321K	Gripper with 3 parallel jaws <b>P12K-100</b> increased force for inductive sensors

### ACCESSORIES FOR P3K-P12K

#### CENTRING RING

Code	Size	Description
W1560649201	64	Kit of centring rings
W1560809201	80	Kit of centring rings
W1561009201	100	Kit of centring rings

Note: 2-pieces pack

#### CABLE WITH STRAIGHT CONNECTOR FOR Ø 6.5 PUSH-IN INDUCTIVE SENSOR (MOBILE INSTALLATION)

Code	Description
02400A0100	M8 female 3 PIN HIGH FLEX CL6 connector with cable L = 1 m
02400A0250	M8 female 3 PIN HIGH FLEX CL6 connector with cable L = 2.5 m
02400A0500	M8 female 3 PIN HIGH FLEX CL6 connector with cable L = 5 m
02400A1000	M8 female 3 PIN HIGH FLEX CL6 connector with cable L = 10 m

Note: Mobile laying cable, class 6 according to IEC 60228

#### CABLE WITH 90° CONNECTOR FOR Ø 6.5 PUSH-IN INDUCTIVE SENSOR (MOBILE INSTALLATION)

Code	Description
02400B0100	M8 female 3 PIN 90° HIGH FLEX CL6 connector with cable L = 1 m
02400B0250	M8 female 3 PIN 90° HIGH FLEX CL6 connector with cable L = 2.5 m
02400B0500	M8 female 3 PIN 90° HIGH FLEX CL6 connector with cable L = 5 m
02400B1000	M8 female 3 PIN 90° HIGH FLEX CL6 connector with cable L = 10 m

Note: Mobile laying cable, class 6 according to IEC 60228

## HYDRAULIC BRAKE SERIES BRK FOR CYLINDER ISO 15552

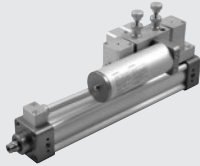

TECHNICAL DATA		Ø 40	Ø 63
Operating temperature	°C	From -10 to +70	
Fluid		Oil, brake fluid provided	
Maximum applicable load	N	7000	25000
Speed	mm/min	See attached diagram	
Standard strokes	mm	50, 100, 150, 200, 250, 300, 350, 400, 450, 500 special strokes up to 1000 on request.	
Versions		Regulation in piston rod extension and/or retraction. SKIP valves. STOP valves. NC or NO Tank in-line or on the side.	
Cylinder fixing		Using flange kit	
ISO 15552 cylinders connected	mm	From Ø 40 to Ø 100	From Ø 100 to Ø 200

### KEY TO CODES

W 1 7 0	0	1	2	0300 STROKE	L
<b>W170</b> BRK hydraulic brake	<b>0</b> Regulation <b>1</b> Regulation + SKIP <b>2</b> Regulation + STOP <b>3</b> Regulation + SKIP + STOP	<b>0</b> Extension <b>1</b> Retraction <b>2</b> Extension and retraction	<b>1</b> No valve or NO <b>2</b> NC <b>* 3</b> + NO STOP in extension <b>* 4</b> + NC STOP in extension <b>* 5</b> + NO STOP in retraction <b>* 6</b> + NC STOP in retraction <b>▲ A</b> + NO SKIP in extension <b>▲ B</b> + NC SKIP in extension <b>▲ C</b> + NO SKIP in retraction <b>▲ D</b> + NC SKIP in retraction	Enter the desired stroke in four digits (e.g. 0500 for stroke 500)	- Ø 40 ● <b>L</b> Ø 40 In-line tank <b>63</b> Ø 63 ● <b>63L</b> Ø 63 In-line tank

- Only for versions with piston rod regulation in extension
- \* In combination with regulation in extension/retraction or regulation + SKIP in extension/retraction
- ▲ In combination with regulation in extension/retraction

## ACCESSORIES

### FLANGE FOR MOUNTING WITH ISO 15552 CYLINDER



Code	Ø	Description
W0950402012	40	Flange Mod. CF-040
W0950502012	50	Flange Mod. CF-050
W0950632012	63	Flange Mod. CF-063
W0950802012	80	Flange Mod. CF-080
W0951002012	100	Flange Mod. CF-100

### FLANGE SCREW KIT

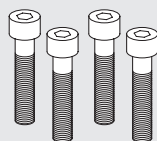

Code	Description	Weight [g]
W0950402111	Kit BRK-P/C-040	58
W0950502111	Kit BRK-P/C-050	93
W0950632111	Kit BRK-P/C-063	97
W0950802111	Kit BRK-P/C-080-100	151

## INTEGRATED HYDRAULIC BRAKE

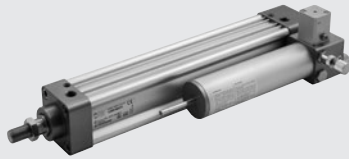

ACTUATORS

HYDRAULIC BRAKE

TECHNICAL DATA		Ø 50	Ø 63	Ø 80	Ø 100
Operating pressure	bar MPa		2 to 8 0.2 to 0.8		
NC valve actuation pressure	bar MPa		29 to 116 3 to 8 0.3 to 0.8		
Operating temperature range	psi °C °F		43.5 to 116 -10 to +70 14 to 156		
Pneumatic circuit fluid		Lubricated or unlubricated filtered air.			
Hydraulic circuit fluid		DEXRON ATF - the list of compatible oils is available on the web site <a href="http://www.metalwork.it">www.metalwork.it</a>			
Thrust force generated at 6 bar	N	1109	1801	2946	4521
Pull force generated at 6 bar	N	883	1292	2437	3756
Maximum load which can be applied from outside while the rod is lock	N				
• Version without valves and with closed pins:					
Thrust Load on the rod			6000		7000
Traction Load on the rod			5000		6000
• Version with STOP NC valves not operated:					
Thrust Load on the rod			6000		7000
Traction Load on the rod			5000		6000
• Version with STOP NO valves operated at 6 bar:					
Thrust Load on the rod			6000		7000
Traction Load on the rod			5000		6000
• Version with STOP NO valves operated at 8 bar:					
Thrust Load on the rod			6000		7000
Traction Load on the rod			5000		6000
Speeds at 6 bar and 20°C		See charts on the following pages 50, 100, 150, 200, 250, 300, 350, 400, 450, 500.			
Standard strokes		Other special strokes up to 500 available on request. Piston-out, piston-in and dual regulation.			
Valve combinations		The following combinations of valves can be mounted on each regulated section: STOP NO, STOP NC, SKIP NO, SKIP NC, DOUBLE STOP NO, DOUBLE STOP NC, DOUBLE SKIP NO, DOUBLE SKIP NC, STOP NO+STOP NC, SKIP NO+SKIP NC, STOP NO+SKIP NO, STOP NC+SKIP NC, STOP NO+SKIP NC, STOP NC+SKIP NO All versions are provided with a magnet			
Sensor magnet					

ACCESSORIES - SEE ISO 15552 CYLINDERS STD PAGE 14

### KEY TO CODES

W 1 7 3	2	3	1	0	0 5 0 0
INTEGRATED BRAKE	REGULATION	PISTON ROD EXTENSION CONTROL VALVES	PISTON ROD RETRACTION CONTROL VALVES	BORE	STROKE
W173 Integrated brake	0 Out 1 In 2 Dual	0 Without valves 1 NO Stop 2 NC Stop 3 NO Skip 4 NC Skip 5 NO Stop NO Skip 6 NO Stop NC Skip 7 NC Stop NO Skip 8 NC Stop NC Skip	0 Without valves 1 NO Stop 2 NC Stop 3 NO Skip 4 NC Skip 5 NO Stop NO Skip 6 NO Stop NC Skip 7 NC Stop NO Skip 8 NC Stop NC Skip	A Ø 50 0 Ø 63 1 Ø 80 2 Ø 100	Specify the desired stroke in 4 digits (e.g. 0500 for stroke 500)

N.B. With at least one extension control valve and one retraction control valve, type W1732\_\_\_ is required.



## ELECTRIC CYLINDER SERIES ELEKTRO ISO 15552

in-line version



geared version



TECHNICAL DATA	Ø 32	Ø 50	Ø 63 - 63 HD	Ø 80	Ø 100
Piston rod thread	M10x1.25	M16x1.5	M16x1.5	M20x1.5	
Environmental temperature range for STEPPING motors	from -10 to +50				
BRUSHLESS motors	from 0 to +40				
Electrical protection rating with STEPPING motors	IP20/IP40 or IP55 (see key to codes on page 53)			IP55	
BRUSHLESS motors	IP40 or IP65 (see key to codes on page 53)			IP65	
Maximum relative humidity of the air for IP55 STEPPING motor	90% with 40°C; 57% with 50°C (no condensate)				
IP65 BRUSHLESS motor	90% (no condensate)				
Minimum stroke for version with non-rotating	Twice the screw pitch (to guarantee ball lubrication)				
Minimum stroke for version without non-rotating	80 (in order to re-grease the screw)			125 (in order to re-grease the screw)	
Maximum stroke	1370	1500			
Positioning repeatability	± 0.02				
Positioning accuracy	± 0.2 **				
Overall radial oscillation of the piston rod (without load) for 100 mm of stroke	0.4				
Versions	With or without piston rod non-rotating			With or without piston rod non-rotating; in line or geared motor; with or without planetary gearbox	
Uncontrolled impact at the end of stroke	NOT ALLOWED (it provides an extra-stroke minimum 5 mm)				
Sensor magnet	YES				
Maximum angle of twist of the piston rod for non-rotating version	1°30'	1°	0°45'	0°35'	0°30'
Work position	Any				

\*\* indicative average data that gets influenced by various factors such as the stroke, the type of motor, the cylinder version, etc ...

MECHANICAL FEATURES	Ø 32	Ø 50	Ø 63	Ø 63 HD	Ø 80	Ø 100
Screw pitch (p)	4   12	5   10   16	5   10   20	5   10	5   10   32	10   40
Screw diameter	12   12	16   16   16	20   20   20	20   20	32   32   32	50   40
Static axial load (F <sub>s</sub> )*	3300		4300		7500	
Dynamic axial load (F)	5200   5600		10500   6670   4330		10010   12800   4880	
Maximum number of revs	4000		3000		2500	
Maximum speed (V <sub>max</sub> )	267   800		250   500   800		208   417   833	
	208   417   833		208   417		165   310   1100	
	165   310   1100		500   1500			

\* N.B.: Static loads bearable without damage. Useful loads are shown in the diagrams on general catalogue.

WEIGHTS (ONLY CYLINDER)	Ø 32	Ø 50	Ø 63 - 63 HD	Ø 80	Ø 100	
Screw pitch (p)	4   12	5   10   16	5   10   20	5   10   32	10   40	
Weight at stroke 0	896   973	1990   2043   2086	2942   3209   3056	8658   8629   8650	15049   13719	
Additional weight each mm of stroke	3.98   3.96	6.64   6.62   6.55	6.25   6.32   6.32	15.6   15.3   16	35.5   26	
Weight of the in-line transmission (without motor)	300		900		1100	
Weight of the geared transmission (without motor)	1100		2000		3000	
Moving mass at stroke 0 (non-rotating version) M <sub>x</sub>	270   353		586   629   703		956   1215   1067	
Additional moving mass each mm of stroke	1.25		1.84		1.98	
	1.25		4.9		15   9.6	

N.B.: You get the total weight of a complete cylinder by adding: weight stroke 0 + stroke [mm] x weight for each mm of stroke + weight of the transmission + weight of the motor

**MASS MOMENTS OF INERTIA**

		Ø 32		Ø 50			Ø 63 - 63 HD		
		4	12	5	10	16	5	10	20 (only Ø63)
Screw pitch	mm	4	12	5	10	16	5	10	20 (only Ø63)
Transmission ratio (τ)		1:1	1:1	1:1	1:1	1:1	1:1	1:1	1:1
J0 at stroke 0	kgmm <sup>2</sup>	1.2407	2.4309	5.3455	6.1360	9.1113	12.4043	14.8767	23.5427
J1 each metre of stroke	kgmm <sup>2</sup> /m	12.2592	17.8468	35.2305	38.5264	49.1936	86.2990	96.6652	116.3671
J2 each kg of load	kgmm <sup>2</sup> /kg	0.4053	4.0858	0.6333	2.5332	6.4849	0.6333	2.5332	10.1327
J3 in-line transmission	kgmm <sup>2</sup>		5.2		5.2			36.2	
J3 geared transmission	kgmm <sup>2</sup>		53.2		126.5			237.7	

		Ø 80			Ø 100		
		5	10	15	10	20	30
Screw pitch	mm	5	10	15	10	20	30
Transmission ratio (τ)		1:1	1:1.25	1:1.5	1:1	1:1.25	1:1.5
J0 at stroke 0	kgmm <sup>2</sup>	430	420.3	438.8	1042.4	1869.3	2593.82
J1 each metre of stroke	kgmm <sup>2</sup> /m	688	608	753	1869.3	1869.3	2593.82
J2 each kg of load	kgmm <sup>2</sup> /kg	0.6333	2.5330	2.5330	40.5284	40.5284	549.8
J3 in-line transmission	kgmm <sup>2</sup>	148.2	-	148.2	-	-	549.8
J3 geared transmission	kgmm <sup>2</sup>	1041.7	388.3	1041.7	388.3	1071.6	1041.7

		Ø 100		
		1:1	1:2	1:3 ●
Screw pitch	mm	10	10	40
Transmission ratio (τ)		1:1	1:2	1:3 ●
J0 at stroke 0	kgmm <sup>2</sup>	1357	1357	1042.4
J1 each metre of stroke	kgmm <sup>2</sup> /m	3984	3984	1869.3
J2 each kg of load	kgmm <sup>2</sup> /kg	2.5330	2.5330	40.5284
J3 in-line transmission	kgmm <sup>2</sup>	327.8	-	594.8
J3 geared transmission	kgmm <sup>2</sup>	1041.7	1161.1	-

● in line with gearbox      The total mass moment of inertia (Jtot) reduced for the motor is:  $J_{tot} = [J1 \cdot corsa [m] + J2 \cdot (Carico [kg] + Mx [kg]) + J0] \cdot \tau^2 + J3$   
Mx is defined in the weight table.

**MOTOR-DRIVE COUPLINGS FOR VARIOUS CYLINDER BORES**

MOTOR CODES		DRIVES CODES				
		Metal Work	37D1222000 *	37D1332000 *	37D1442000	37D1552000
Metal Work	Manufacturer	RTA CSD 94	RTA NDC 96	RTA PLUS A4	RTA PLUS B7	X-MIND B6
		(4.4A 24 - 48VDC)	(6A 24 - 75VDC)	(6A 77 - 140VDC)	(10A 28 - 62VAC) ●	(6A 110 - 230VAC) ●
<b>STEPPING</b>						
37M1110000	Motor SANYO DENKI 103-H7123-1749 (4A 75V max)	Ø32	Ø32 ◆	-	Ø32 ■	-
37M1120000	Motor SANYO DENKI 103-H7126-1740 (4A 75V max)	Ø32	Ø32 ◆	-	Ø32 ■	-
37M1120001	Motor SANYO DENKI 103-H7126-6640 (5.6A 75V max)	-	Ø32 ◆	-	Ø32 ■	-
37M1430000	Motor SANYO DENKI 103-H8221-6241 (6A 140V max)	-	Ø50	Ø 50	Ø50 ◆	Ø50 ▲
37M1440000	Motor SANYO DENKI 103-H8222-6340 (6A 140V max)	-	Ø50	Ø 50	Ø50 ◆	Ø50 ▲
37M1450000	Motor SANYO DENKI SM-2863-5255 (6A 140V max)	-	Ø63 - Ø63 HD	Ø63 - Ø63 HD	Ø63 - Ø63 HD ◆	Ø63 - Ø63 HD ▲
37M1470000	Motor B&R 80MPH6.101S000-01 (10A 80V max)	-	-	-	Ø63 HD	-
37M1890000	Motor SANYO DENKI 103-H89223-6341 (6A 230V max)	-	-	-	-	Ø80 - Ø100
<b>STEPPING WITH BRAKE</b>						
37M5120000	Motor SANYO DENKI 103-H7126-1710B (4A 75V max)	Ø32	Ø32 ◆	-	Ø32 ■	-
<b>STEPPING WITH BRAKE + ENCODER</b>						
37M3220000	Motor B&R 80MPF3.500D114-01 (5A 80V max)	-	Ø32 ◆	Ø32 ■	Ø32 ■	-
37M3230000	Motor B&R 80MPF5.500D114-01 (5A 80V max)	-	Ø32 ◆	Ø32 ■	Ø32 ■	-
37M3430000	Motor B&R 80MPH1.600D114-01 (6A 80V max)	-	Ø50	Ø50 ▲	Ø50 ◆	-
37M3460000	Motor B&R 80MPH3.600D114-01 (6A 80V max)	-	Ø50 - Ø63 - Ø63 HD	Ø50 - Ø63 - Ø63 HD ▲	Ø50 - Ø63 - Ø63 HD ◆	-
37M3450000	Motor B&R 80MPH4.101D114-01 (10A 80V max)	-	-	-	Ø63 - Ø63 HD	-
37M3470000	Motor B&R 80MPH6.101D114-01 (10A 80V max)	-	-	-	Ø63 HD	-

\* In all applications requiring motor powered up to 6A / 55VDC, the programmable drive e.drive, code 37D1332002, can be used.

- ◆ Important! Limit current
- Important! Limit current and voltage
- ▲ Important! Limit voltage
- Important! AC drive to continuous voltage  $VDC = VAC \cdot \sqrt{2}$

MOTOR CODES		DRIVES CODES	
		Metal Work	37D2400008
Metal Work	Manufacturer	SANYO DENKI RS3A03	37D2600001
		(30A 200-1000 W)	DELTA ASD-A2-3043-M
			(3000W)
<b>BRUSHLESS</b>			
37M2200000	Motor SANYO DENKI R2AA06020FXH11M (200W)	Ø32	-
37M2220000	Motor SANYO DENKI R2AA06040FXH11M (400W)	Ø32 - Ø50	-
37M2330000	Motor SANYO DENKI R2AA08075FXH11M (750W)	Ø50 - Ø63 - Ø63 HD	-
37M2540000	Motor SANYO DENKI R2AAB8100HXH29M (1000W)	Ø63 HD - Ø80	-
37M2770000	Motor DELTA ECMA-J11330R4 (3000W)	-	Ø80 - Ø100
<b>BRUSHLESS WITH BRAKE</b>			
37M4200000	Motor SANYO DENKI R2AA06020FCH11M (200W)	Ø32	-
37M4220000	Motor SANYO DENKI R2AA06040FCH11M (400W)	Ø32 - Ø50	-
37M4330000	Motor SANYO DENKI R2AA08075FCH11M (750W)	Ø50 - Ø63 - Ø63 HD	-
37M4540000	Motor SANYO DENKI R2AAB8100HCH29M (1000W)	Ø63 HD - Ø80	-
37M4770000	Motor DELTA ECMA-J11330S4 (3000W)	-	Ø80 - Ø100

**KEY TO CODES CYLINDER WITHOUT MOTOR**

CYL	37 TYPE	1	032 SIZE	0100 STROKE	1 SCREW PITCH	5 VERSION
	37 Electric actuators	1 ISO 15552 electric cylinder	032 32 050 50 063 63 ◆ H63 63 Heavy Duty ◀ 080 80 ◀ 100 100		1 Pitch 4 2 Pitch 5 4 Pitch 10 5 Pitch 12 6 Pitch 16 7 Pitch 20 8 Pitch 32 9 Pitch 40	5 Without antirotation IP40 6 With antirotation IP40 7 Without antirotation IP55/IP65 8 With antirotation IP55/IP65

N.B.: For the possible ordering codes, see below.

- ◆ Only for Ø63 with screw pitch 5 or pitch 10
- ◀ Only for versions 7 and 8

N.B.: An piston rod anti-rotation system must be used. If the piston rod is not fixed firmly to an element, a flange or to any other device preventing it from rotating, a cylinder in the anti-rotation version must be used.

**KEY TO CODES CYLINDER WITH MOTOR**

CYL	37 TYPE	1	032 SIZE	0100 STROKE	1 SCREW PITCH	1 VERSION	1 MOTOR	2 FLANGE	2 TORQUE	0
	37 Electric actuators	1 ISO 15552 electric cylinder	032 32 050 50 063 63 ◆ H63 63 Heavy Duty ◀ 080 80 ◀ 100 100		1 Pitch 4 2 Pitch 5 4 Pitch 10 5 Pitch 12 6 Pitch 16 7 Pitch 20 8 Pitch 32 9 Pitch 40	<b>IN-LINE</b> ● 1 Without antirotation IP40/IP20 ● 2 With antirotation IP40/IP20 ■ 3 Without antirotation IP55/IP65 ■ 4 With antirotation IP55/IP65  <b>GEARED</b> ● 5 Without antirotation IP40/IP20 ● 6 With antirotation IP40/IP20 ■ 7 Without antirotation IP55/IP65 ■ 8 With antirotation IP55/IP65	1 STEPPING 2 BRUSHLESS 3 STEPPING with BRAKE + Encoder 4 BRUSHLESS with BRAKE 5 STEPPING with BRAKE without Encoder 6 BRUSHLESS with gear box 7 BRUSHLESS with BRAKE + gear box	1 NEMA 23 2 60 3 80 4 NEMA 34 5 86 7 130 8 NEMA 42	0 0÷0.79 Nm 1 0.8÷1.19 Nm 2 1.2÷2.19 Nm 3 2.2÷3 Nm 4 3.01÷5 Nm 5 6.21÷7 Nm 6 5.01÷6.2 Nm 7 7.01÷10 Nm 9 15.01÷25 Nm	0 Base 1 Greater rpm

N.B.: For the possible ordering codes, see below.

- ◆ Only for Ø63 with screw pitch 5 or pitch 10
- ◀ Only for versions 3, 4, 7 and 8
- Version IP40 available for all STEPPING and BRUSHLESS motors, for only the sizes 32, 50 and 63, with the exception of motor code 37M5120000 which it is IP20;
- Version IP55 available for STEPPING motors, for only the sizes 50, 63, 80 and 100 all the motors, with the exception of motor code 37M1470000; for Ø 32 only for motor code 37M1120001; version IP65 available for BRUSHLESS motors, BRUSHLESS with BRAKE and STEPPING with BRAKE + ENCODER motors (all sizes).

N.B.: An piston rod anti-rotation system must be used. If the piston rod is not fixed firmly to an element, a flange or to any other device preventing it from rotating, a cylinder in the anti-rotation version must be used.

**POSSIBLE ORDERING CODES**

Ø 32	Ø 50	Ø 63	Ø 63 HD	Ø 80	Ø 100
Drive Version Screw pitch 371032_ 1 1 1110 5 2 1120 5 5 1121 6 5120 2200 2220 3220 3230 4200 4220  3 1121 4 2200 7 2220 8 3220 3230 4200 4220	Drive Version Screw pitch 371050_ 2 1 1430 4 2 1440 6 3 2220 4 2330 5 3430 6 3460 7 4220 8 4330	Drive Version Screw pitch 371063_ 2 1 1450 4 2 2330 7 3 3450 4 3460 5 4330 6 7 8	Drive Version Screw pitch 371H63_ 2 1 1450 4 2 1470 5 2330 6 2540 3450 3460 3470 4330 4540  3 1450 4 2330 7 2540 8 3450 3460 3470 4330 4540	Drive Version Screw pitch 371080_ 2 3 1890 4 2540 7 4540 8  4 3 1890 4 2540 7 2770 8 4540 4770	Drive Version Screw pitch 371100_ 4 3 1890 9 4 2770 4770  7 1890 8 2770 4770
_____ = Enter the stroke in mm					

**ACCESSORIES EXAMPLE: 0950322107 ( FOR Ø 100 = A1)**

**FOOT MODEL A**

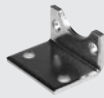

Code	Ø	Material
W0950_2001	32-63	Steel
W095E_2001	80-100	Steel

**FOOT ON CYLINDER HEADS**

Code	Ø
0950807042	80
0951007042	100

**INTERMEDIATE HINGE MODEL EN**



Code	Ø	Material
0950_2107	32-63	Steel

**FEMALE HINGE MODEL B**



Code	Ø	Material
W0950_2003	32-63	Aluminium
W095E_2003	32-100	Steel

**MALE HINGE MODEL BA**



Code	Ø	Material
W0950_2004	32-63	Aluminium
W095E_2004	32-100	Steel

**POSITION SENSORS**

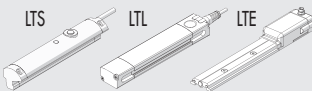

For technical data and usage strokes see page 84.

**ARTICULATED MALE HINGE MODEL BAS**



Code	Ø	Material
W0950_2006	32-63	Aluminium
W095E_2006	32-100	Steel

**CETOP HINGE FOR MODEL B - MODEL GL**



Code	Ø	Material
W0950_2008	32-63	Aluminium

**COUNTER-HINGE FOR MODEL B - MODEL GS**



Code	Ø	Material
W0950_2108	32-63	Aluminium

**ISO 15552 HINGE FOR MODEL B - MODEL AB7**



Code	Ø	Material
W0950_2017	32-63	Aluminium
W095E_2017	32-100	Steel

**ROD NUT CYL. 15552 MODEL S**



Code	Ø	Description
0950322010	32	M10x1.25
0950502010	50/63	M16x1.5
0950802010	80/100	M20x1.5

**FORK MODEL GK-M**



Code	Ø	Description
W0950322020	32	M10x1.25
W0950502020	50/63/63 HD	M16x1.5
W0950802020	80/100	M20x1.5

**ROD EYE MODEL GA-M**



Code	Ø	Description
W0950322025	32	M10x1.25
W0950502025	50/63/63 HD	M16x1.5
W0950802025	80/100	M20x1.5

**GDH: H PROFILE FOR HIGH LOAD**



Code	Ø
W0700_2_*	32-63
W070E_2_*	80-100

**GDM: H PROFILE FOR HIGH SPEEDS**



Code	Ø
W0700_3_*	32-63
W070E_3_*	80-100

\* CODE EXAMPLE TO ORDER  
**W0700322100 ( FOR Ø 100 = A1)**  
 STANDARD STROKE  
 50 - 100 - 150 - 200 - 250 - 320 - 400 - 500

**FRONT FLANGE - MODEL C**



Code	Ø
W0950_2002	32-63

**COUNTER-HINGE FOR MODEL EN MODEL EL**

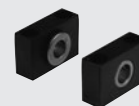

Code	Description
W0950322009	032
W0950402009	040/050
W0950632009	063/080

**SELF ALIGNING ROD COUPLER MODEL GA-K**



Code	Ø	Description
W0950322030	32	M10x1.25
W0950502030	50/63/63 HD	M16x1.5
W0950802030	80/100	M20x1.5

**GREASING NEEDLE**



Code	Ø
0950327108	32
0950507108	50
0950637108	63/80/100 (pitch 10)
0951007108	100 (pitch 40)

**GREASE**

Code	Description
9910506	RHEOLUBE 363 AX1 (400 g)

**SPARE PARTS**

**GEARBOX**

Code	Description
37R0364000	MP105 1:3

**NOTES**

---

---

---

---

---

---

---

---

## ELECTRIC CYLINDER SERIES ELEKTRO ISO 15552 EK

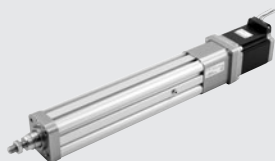

TECHNICAL DATA		Ø 32
Piston rod thread	mm	M10x1.25
Environmental temperature range for STEPPING motors	°C	from -10 to +50
BRUSHLESS motors	°C	from 0 to +40
Electrical protection rating with motors		IP40
Minimum stroke		Twice the screw pitch (to guarantee ball lubrication)
Maximum stroke	mm	500
Positioning repeatability	mm	± 0.02 with screw/ball screw nut; ± 0.15 with trapezoidal screw (acme)
Positioning accuracy	mm	± 0.2 **
Overall radial oscillation of the piston rod (without load) for 100 mm of stroke	mm	0.4
Versions		Ball screw; trapezoidal screw (acme) with bronze bushing
Anti-rotation of the piston rod		YES
Maximum angle of twist of the piston rod		1°30'
Motor layout		In line with piston rod axis
Uncontrolled impact at the end of stroke		NOT ALLOWED (it provides an extra-stroke minimum 5 mm)
Sensor magnet		YES
Work position		Any

\*\* indicative average data that gets influenced by various factors such as the stroke, the type of motor, the cylinder version, etc ...

MECHANICAL FEATURES		Ball screw		Trapezoidal screw (acme) with bronze bushing
Screw pitch (p)	mm	4	10	4
Screw diameter	mm	12	12	14
Static axial load (F <sub>s</sub> )*	N	3000	3000	3000
Dynamic axial load (F)	N	5200	3160	see graph force/speed
		Calculate mean axial load and the calculate life		<b>N.B.:</b> 40% duty cycle, i.e. the cylinder must work maximum 40% of time to allow the screw/ball screw nut to cool down.
Maximum number of revs	1/min	3000	3000	750
Maximum speed (V <sub>max</sub> )	mm/s	200	500	50
"K" ratio of motor revs and piston rod speed	n/V	15	6	15

Example: V = 100 mm/s; pitch = 10 → K=6 n= V x K = 100 x 6 = 600 rpm

\* **N.B.:** Static loads bearable without damage. Useful loads are shown in the diagrams on general catalogue.

WEIGHTS (ONLY CYLINDER)		Ball screw		Trapezoidal screw (acme) with bronze bushing
Screw pitch (p)	mm	4	10	4
Weight at stroke 0, without motor	g	610	620	720
Additional weight each mm of stroke	g	4.3	4.3	4.3
Moving mass at stroke 0 (M <sub>x</sub> )	g	189.4	189.4	209.4
Additional moving mass each mm of stroke	g	1.3	1.3	1.3

**N.B.:** You get the total weight of a complete cylinder by adding: weight stroke 0 + stroke [mm] x weight for each mm of stroke + weight of the motor.

MASS MOMENTS OF INERTIA		Ball screw		Trapezoidal screw (acme) with bronze bushing
Screw pitch	mm	4	10	4
J0 at stroke 0	kgmm <sup>2</sup>	9.9849	10.0979	10.2979
J1 each metre of stroke	kgmm <sup>2</sup> /m	12.76	13.76	16.81
J2 each kg of load	kgmm <sup>2</sup> /kg	0.4053	2.533	0.4053

The total mass moment of inertia (J<sub>tot</sub>) reduced for the motor is: J<sub>tot</sub> = J0 + J1 · stroke [m] + J2 · (load [kg] + M<sub>x</sub> [kg])

M<sub>x</sub> is defined in the weights table.

**MOTOR-DRIVE COUPLINGS**

MOTOR CODES		DRIVES CODES		
Metal Work	Manufacturer	37D1222000 *	37D1332000 *	37D1552000
		RTA CSD 94	RTA NDC 96	RTA PLUS B7
		(4.4A 24÷48VDC)	(6A 24÷75VDC)	(10A 28÷62VAC) ●
<b>STEPPING</b>				
37M1120001	Motor SANYO DENKI 103-H7126-6640 (5.6A 75V max)	-	√	√ ■
37M1230000 ▲	Motor SANYO DENKI 103-H7823-1740 (4A 75V max)	√	√ ◆	√ ■
<b>STEPPING WITH BRAKE</b>				
37M5120000	Motor SANYO DENKI 103-H7126-1710B (4A 75V max)	√	√ ◆	√ ■

\* In all applications requiring motor powered up to 6A / 55VDC, the programmable drive e.drive, code 37D1332002, can be used.

◆ **Important!** Limit current

■ **Important!** Limit current and voltage

● **Important!** AC drive to continuous voltage  $VDC = VAC \cdot \sqrt{2}$

▲ Used for trapezoidal screws only

MOTOR CODES		DRIVES CODES	
Metal Work	Manufacturer	37D2200001	DELTA ASD-A2-0221-M
			(200W)
<b>BRUSHLESS</b>			
37M2200001	Motor DELTA ECMA-C20602RS (200W)		√
<b>BRUSHLESS WITH BRAKE</b>			
37M4200001	Motor DELTA ECMA-C20602SS (200W)		√

**KEY TO CODES**

CYL	37	1	E	32	0500	1	2	1	1	2	1
	TYPE	FAMILY	SERIES	SIZE	STROKE	SCREW PITCH	VERSION		DRIVE		
	37 Electric actuators	1 ISO 15552 electric cylinder	E Elektro EK	32 Ø32		1 With pitch 4 ball screw 4 With pitch 10 ball screw T With pitch 4 trapezoidal screw (acme)	2 With antirotation, IP40	1 STEPPING 2 BRUSHLESS 4 BRUSHLESS with BRAKE 5 STEPPING WITH BRAKE (without encoder)	1 NEMA 23 2 60x60	0 0 - 0.79 Nm 2 1.2 - 2.19 Nm 3 2.2 - 3 Nm	0 Base 1 Greater rpm

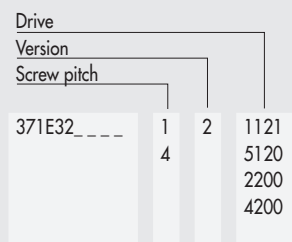
**POSSIBLE ORDERING CODES**
**Ø 32 with ball screw**

\_ \_ \_ \_ = Enter the stroke in mm

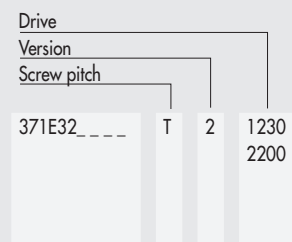
**Ø 32 with trapezoidal screw (acme)**

\_ \_ \_ \_ = Enter the stroke in mm

**ACCESSORIES**

For accessories see page 54.

**BRACKET FOR REAR FIXING**

STEEL	Code	Ø	ØAB	TG	TR	E	AT	SA	AO	AU	AH	L	Weight [g]	Fmax [N]
	0950327090	32	6.5	32.5	32	63	30	107	48	45	30.5	146	375	1600
	0950327091	32	6.5	32.5	32	67	30	144.5	48	45	30.5	183.5	445	1600

Note: Supplied complete with 4 screws and 4 washers for fixing to the cylinder, 4 self-locking nuts and 4 screws for fixing the anchor clamp.

N.B.: Code 0950327090 can be used with motor 37M1120001.

Code 0950327091 can be used with motors 37M2200001, 37M1230000 and 37M5120000.

A bracket suitable for motor 37M4200001 is not provided.



## ELECTRIC CYLINDER SERIES ELEKTRO ROUND DC

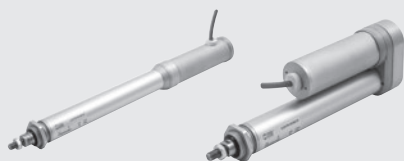

TECHNICAL DATA		Ø 32 Pitch 4	Ø 32 Pitch 20
Temperature range	°C	from -20 to +60	
Degree of protection		IP65	
Gearing ratio of the planetary gear box	mm	1/13 or 1/25	
Minimum stroke	mm	25	50
Maximum stroke	mm	1000	
Piston rod diameter	mm	20	
Maximum thrust	N	see general catalogue	
Maximum speed	mm/s	see general catalogue	
Maximum load in vertical position and motor powered off (reversibility)	N	irreversible (max recommended 1000)	90 with 1/25 gear ratio 40 with 1/13 gear ratio
Work cycle at 25°C (duty cycle)	%	20 (example: 2 min. ON 8 min. OFF)	
Overall radial oscillation of the piston rod (without load) for 100 mm of stroke	mm	0.4	
Versions		In-line or geared	
Uncontrolled impact at the end of stroke		NOT ALLOWED (it provides an extra-stroke minimum 5 mm)	
Sensor magnet		YES	
Work position		Any	
Motor		Direct current DC	
Supply voltage	VDC	12 or 24	
Input power with MAX torque	W	24	
Input current with MAX torque	A	2 (12VDC) 1 (24VDC)	
Interference suppression		VDR and capacitors	
Direction of rotation		according to polarity	
Encoder		two channels, three pulses per rev for each channel, NPN	
Motor protection		Overload and short-circuiting protection using resettable fuse (optional)	
Power cable (length)	m	2	
Weight at stroke 0, in-line version	g	1247	1224
Weight at stroke 0, geared version	g	1461	1437
Additional weight for each mm stroke	g	1.4	

### KEY TO CODES

CYL	37 TYPE	2	0	32 BORE	0100 STROKE	1 SCREW PITCH	3 VERSION	3 DRIVE	2 SUPPLY VOLTAGE	0 GEAR RATIO	1 CYLINDER END TYPES
	37 Electric actuators	2 Cylinder Elektro Round DC	0 STD	32		1 Screw pitch 4 7 Screw pitch 20	3 In-line without antirotation IP65 7 Geared without antirotation IP65	3 Motor Direct current	1 12VDC 2 24VDC 3 12VDC + Encoder 4 24VDC + Encoder 5 12VDC + fuse 6 24VDC + fuse 7 12VDC + Encoder + fuse 8 24VDC + Encoder + fuse	0 1/13 1 1/25	1 Thread male 2 Nose piece drilled 3 Nose piece female 4 Piston rod female 5 Nose piece drilled and rear hinge

◆ For the version with a female piston rod, a cap must be provided on the piston rod to ensure IP65 protection.

## ACCESSORIES

### FOOT



Code	Description
W095032C001	Foot for cylinder Elektro ROUND DC Ø 32

### INTERMEDIATE HINGE

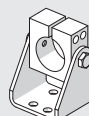

Code	Description
W095032C027	Intermediate hinge for cylinder Elektro ROUND DC Ø 32

### ROD NUT - MODEL S



Code	Description
0950322010	Rod nut modele S M10x1.25

### ARTICULATED MALE HINGE



Code	Description
W095032C006	Articulated male hinge for cylinder Elektro ROUND DC Ø 32

### HEAD PIECE RING NUT



Code	Description
W095032C010	Head piece ring nut for cylinder Elektro ROUND DC Ø 32

## ELECTRIC AXIS SERIES ELEKTRO SHAK



TECHNICAL DATA		SHAK 340	SHAK 470
<b>WITH STEPPING MOTORS</b>			
Ambient temperature	°C	-10 ÷ +50	
Maximum relative humidity		90% at 40°C / 57% at 50°C (no condensate)	
Maximum value of duty cycle		50%	
Maximum value of axial force available (with Metal Work motors)			
without brake	N	150	250
with brake	N	180	250
Maximum speed without load			
without brake and without gear box	m/s	2.5	2
with brake and without gear box	m/s	2	2
Maximum acceleration without load	m/s <sup>2</sup>	50	50
Maximum admissible mass	kg	5	7.5
<b>WITH BRUSHLESS MOTORS</b>			
Ambient temperature	°C	0 ÷ +40	
Maximum relative humidity		90% (no condensate)	
Maximum value of duty cycle		100%	
Maximum value of axial force available (with Metal Work motors)			
without gear box	N	70	80
with gear box	N	600	700
Maximum speed without load			
without gear box	m/s	5	5
with gear box	m/s	2.4	2.7
Maximum acceleration without load	m/s <sup>2</sup>	50	50
Maximum admissible mass			
without gear box	kg	3	3
with gear box	kg	15	25
<b>MECHANICAL CHARACTERISTICS</b>			
Maximum movable mass	kg	15	25
Maximum speed (empty)	m/s	5	5
Maximum acceleration (empty)	m/s <sup>2</sup>	50	50
Maximum axial force	N	800	1000
Maximum force applicable on the pulley	Nm	15	25
Standard strokes (special execution on request)	mm	400	800
		600	1200
		800	1600
		1000	2000
		1200	2400
Repetition accuracy	mm	±0.05	
Noise level	dBA	<66	
Mounting position		Any	
Protection level		IP30	
Toothed belt pitch	mm	5	
Type of belt		PowerGrip® LL GT 5MR 25 FV	PowerGrip® LL GT 5MR 30 ST
Belt elongation at maximum load		0.15%	0.25%
Pulley pitch diameter	mm	35.01	44.56
Stroke / Revolution	mm/rev	110	140
Homing position sensor		Inductive sensor switch	
<b>MASS AND MOMENT OF INERTIA</b>			
Weight without motor	kg	7.7 (stroke 400)	15.9 (stroke 800)
		9 (stroke 600)	19.8 (stroke 1200)
		10.4 (stroke 800)	23.6 (stroke 1600)
		11.7 (stroke 1000)	27.5 (stroke 2000)
		13 (stroke 1200)	31.2 (stroke 2400)
Motor weight	kg		
Stepping motor without brake		2.5	4.2
Stepping motor with brake		3.7	4.5
Brushless motor without brake		1.3	2.6
Brushless motor with brake		1.7	2.2
Moving mass	kg		
		1.28 (stroke 400)	2.18 (stroke 800)
		1.32 (stroke 600)	2.28 (stroke 1200)
		1.36 (stroke 800)	2.38 (stroke 1600)
		1.40 (stroke 1000)	2.48 (stroke 2000)
		1.44 (stroke 1200)	2.58 (stroke 2400)
Gear box weight	kg	0.8	4
Reduced inertia at motor (without load)	kg mm <sup>2</sup>		
Versions without gear box		450 (stroke 400)	1.414 (stroke 800)
		462 (stroke 600)	1.467 (stroke 1200)
		474 (stroke 800)	1.520 (stroke 1600)
		486 (stroke 1000)	1.573 (stroke 2000)
		498 (stroke 1200)	1.626 (stroke 2400)
Versions with gear box		158 (stroke 400)	530 (stroke 800)
		162 (stroke 600)	548 (stroke 1200)
		166 (stroke 800)	566 (stroke 1600)
		170 (stroke 1000)	584 (stroke 2000)
		174 (stroke 1200)	602 (stroke 2400)

**MOTOR-DRIVE COUPLINGS**

MOTOR CODES		Metal Work	37D1332000	DRIVES CODES	37D1442000	37D1552000
Metal Work	Manufacturer	Manufacturer	RTA NDC 96	RTA PLUS A4	RTA PLUS B7	
			(6A 24÷75VDC)	(6A 77÷140VDC)	(10A 28÷62VAC) ●	
<b>STEPPING</b>						
37M1440000	Motor SANYO DENKI 103-H8222-6340 (6A 140V max)		SHAK 340	SHAK 340	SHAK 340 ◆	
37M1470000	Motor B&R 80MPH6.101S000-01 (10A 80V max)		-	-	SHAK 470	
<b>STEPPING WITH BRAKE + ENCODER</b>						
37M3450000	Motor B&R 80MPH4.101D114-01 (10A 80V max)		-	-	SHAK 340	
37M3470000	Motor B&R 80MPH6.101D114-01 (10A 80V max)		-	-	SHAK 470	
MOTOR CODES		Metal Work	37D2400008	DRIVES CODES	37D2400008	
Metal Work	Manufacturer	Manufacturer	SANYO DENKI RS3A03	(30A 400÷750 W)		
<b>BRUSHLESS</b>						
37M2220000	Motor SANYO DENKI R2AA06040FXH11M (400W)			SHAK 340		
37M2330000	Motor SANYO DENKI R2AA08075FXH11M (750W)			SHAK 470		
<b>BRUSHLESS WITH BRAKE</b>						
37M4220000	Motor SANYO DENKI R2AA06040FCH11M (400W)			SHAK 340		
37M4330000	Motor SANYO DENKI R2AA08075FCH11M (750W)			SHAK 470		

◆ Important! Limit current

 ● Important! AC drive to continuous voltage  $VDC = VAC \cdot \sqrt{2}$ 

The motor must be controlled in such a way as to avoid sudden changes in speed.

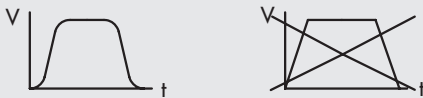
**KEY TO CODES (WITHOUT MOTOR)**

CYL	37	5	0	1	0	0800	0
	TYPE			SIZE		STROKE ◆	
	37 Electric actuators	5 SHAK electric axes	0 STD	1 Size 340	0 STD	400 600 800 1000 1200	0 STD
				2 Size 470		800 1200 1600 2000 2400	

◆ Other strokes on request.

**KEY TO CODES AXIS ELECTRIC MOTOR**

CYL	37	5	0	1	0	0800	0	0	0	2	2	2	0
	TYPE			SIZE		STROKE ◆		REDUCTION	MOTOR POSITION	MOTOR	FLANGE	TORQUE	
	37 Electric actuators	5 SHAK electric axes	0 STD	1 Size 340	0 STD	400 600 800 1000 1200	0 STD	0 No reduction 1 1:3 ratio	0 Top left 1 Bottom left 2 Top right 3 Bottom right	1 STEPPING 2 BRUSHLESS 3 STEPPING with BRAKE (+ Encoder) 4 BRUSHLESS with BRAKE	2 60 3 80 4 NEMA 34	2 1.2÷2.19 Nm 3 2.2÷3 Nm 4 3.01÷5 Nm 5 6.21÷7 Nm 7 > 7 Nm	0 STD
				2 Size 470		800 1200 1600 2000 2400							

◆ Other strokes on request.

N.B. The available configurations are shown on the next pages.

ORDERING CODES	BRUSHLESS MOTOR		BRUSHLESS MOTOR WITH BRAKE		BRUSHLESS MOTOR WITH GEARBOX		BRUSHLESS MOTOR WITH GEARBOX AND BRAKE		STEPPING MOTOR		STEPPING MOTOR WITH BRAKE	
	375010	0002220	375010	0004220	375010	0102220	375010	0104220	375010	0001440	375010	0003450
	375010	0012220	375010	0014220	375010	0112220	375010	0114220	375010	0011440	375010	0013450
	375010	0022220	375010	0024220	375010	0122220	375010	0124220	375010	0021440	375010	0023450
	375010	0032220	375010	0034220	375010	0132220	375010	0134220	375010	0031440	375010	0033450

----- = Standard stroke (0400; 0600; 0800; 1000; 1200)

ORDERING CODES	BRUSHLESS MOTOR		BRUSHLESS MOTOR WITH BRAKE		BRUSHLESS MOTOR WITH GEARBOX		BRUSHLESS MOTOR WITH GEARBOX AND BRAKE		STEPPING MOTOR		STEPPING MOTOR WITH BRAKE	
	375020	0002330	375020	0004330	375020	0102330	375020	0104330	375020	0001470	375020	0003470
	375020	0012330	375020	0014330	375020	0112330	375020	0114330	375020	0011470	375020	0013470
	375020	0022330	375020	0024330	375020	0122330	375020	0124330	375020	0021470	375020	0023470
	375020	0032330	375020	0034330	375020	0132330	375020	0134330	375020	0031470	375020	0033470

----- = Standard stroke (0800; 1200; 1600; 2000; 2400)

## ACCESSORIES

### OIL

Code	Description	Volume [ml]
9910490	PARALIQ P 460	80

### CABLE TRAY CHAIN

Code	Description
095340A0400	Cable tray chain accessory kit SHAK-340-400
095340A0600	Cable tray chain accessory kit SHAK-340-600
095340A0800	Cable tray chain accessory kit SHAK-340-800
095340A1000	Cable tray chain accessory kit SHAK-340-1000
095340A1200	Cable tray chain accessory kit SHAK-340-1200
095470A0800	Cable tray chain accessory kit SHAK-470-800
095470A1200	Cable tray chain accessory kit SHAK-470-1200
095470A1600	Cable tray chain accessory kit SHAK-470-1600
095470A2000	Cable tray chain accessory kit SHAK-470-2000
095470A2400	Cable tray chain accessory kit SHAK-470-2400

WARNING! You cannot mount the chain on versions with motor or gearmotor at the top right

## SPARE PARTS

### SHAK

Code	Description
37R0341000	Gear unit for SHAK 340 1:3
37R0343000	Gear unit for SHAK 470 1:3

### SHAK INDUCTIVE SENSOR

Code	Description
095340A0000	SHAK inductive sensor accessory kit

### ELECTRIC MOTORS



See page 68

### DRIVES



See page 73

## ELECTRIC AXIS SERIES ELEKTRO SHAK GANTRY



TECHNICAL DATA		SHAK GANTRY 340		SHAK GANTRY 470	
Ambient temperature	°C	from -10 to +50			
Maximum relative humidity		90% (no condensate)			
Maximum value of duty cycle		100%			
Maximum X-axis empty speed	m/s	1.8		2.1	
Maximum Y-axis empty speed	m/s	2.4		2.7	
Maximum X-axis empty acceleration	m/s <sup>2</sup>	35		25	
Maximum Y-axis empty acceleration	m/s <sup>2</sup>	50		50	
Maximum admissible mass	kg	15		25	

MECHANICAL CHARACTERISTICS		SHAK GANTRY 340		SHAK GANTRY 470	
Maximum axial force	N	800		1000	
Maximum force applicable on the pulley	Nm	15		25	
Standard strokes (special execution on request)		<b>X-axis</b>	<b>Y-axis</b>	<b>X-axis</b>	<b>Y-axis</b>
(see dimensional drawings for standard combinations)	mm	400	400	800	600
	mm	600	600	1200	1000
	mm	800	800	1600	1400
	mm	1000	1000	2000	1800
	mm	1200	1200	2400	2200
Repetition accuracy	mm	±0.05			
Noise level	dBA	<66			
Mounting position		Horizontal			
Planarity required for the support surface	mm/m	0.1			
Protection level		IP30			
Toothed belt pitch	mm	5			
Type of belt		PowerGrip® LL GT 5MR 25 FV		PowerGrip® LL GT 5MR 30 ST	
Belt elongation at maximum load		0.15%		0.25%	
Pulley pitch diameter	mm	35.01		44.56	
Stroke / Revolution	mm/rev	110		140	
Homing position sensor		Inductive sensor switch			

MASS AND MOMENT OF INERTIA		SHAK GANTRY 340 X-AXIS	SHAK GANTRY 340 Y-AXIS	SHAK GANTRY 470 X-AXIS	SHAK GANTRY 470 Y-AXIS
Weight (without motor and gear box)	kg	16.2 (stroke 400)	7.7 (stroke 400)	32.7 (stroke 800)	15.9 (stroke 600)
		19 (stroke 600)	9 (stroke 600)	40.9 (stroke 1200)	19.8 (stroke 1000)
		21.9 (stroke 800)	10.4 (stroke 800)	48.8 (stroke 1600)	23.6 (stroke 1400)
		24.6 (stroke 1000)	11.7 (stroke 1000)	56.9 (stroke 2000)	27.5 (stroke 1800)
		27.5 (stroke 1200)	13 (stroke 1200)	64.6 (stroke 2400)	31.2 (stroke 2200)
Motor weight	kg	1.3	1.3	2.6	2.6
		0.8	0.8	4	4
Gear unit weight	kg	10.3 (stroke 400)	1.28 (stroke 400)	20.3 (stroke 800)	2.18 (stroke 600)
		11.6 (stroke 600)	1.32 (stroke 600)	24.4 (stroke 1200)	2.28 (stroke 1000)
Moving mass (without motor and gear box)	kg	13.1 (stroke 800)	1.36 (stroke 800)	28.4 (stroke 1600)	2.38 (stroke 1400)
		14.5 (stroke 1000)	1.40 (stroke 1000)	32.5 (stroke 2000)	2.48 (stroke 1800)
		15.9 (stroke 1200)	1.44 (stroke 1200)	36.4 (stroke 2400)	2.58 (stroke 2200)
		476 (stroke 400)	158 (stroke 400)	1759 (stroke 800)	530 (stroke 600)
		523 (stroke 600)	162 (stroke 600)	1986 (stroke 1200)	548 (stroke 1000)
Reduced inertia at motor (with motor and gear box)	kg mm <sup>2</sup>	573 (stroke 800)	166 (stroke 800)	2207 (stroke 1600)	566 (stroke 1400)
		620 (stroke 1000)	170 (stroke 1000)	2434 (stroke 2000)	584 (stroke 2000)
		667 (stroke 1200)	174 (stroke 1200)	2650 (stroke 2400)	602 (stroke 2200)

CONNECTION JOINT		SHAK GANTRY 340 Y-AXIS	SHAK GANTRY 470 Y-AXIS
Max. number of revs	rpm	2000 (all strokes)	2000 (stroke 600/1000/1400) 1400 (stroke 1800) 1000 (stroke 2200)
Maximum transmissible torque	Nm	25 (hole Ø12)	32 (hole Ø15)

**MOTOR-DRIVE COUPLINGS**

MOTOR CODES		Metal Work Manufacturer	DRIVES CODES 37D2400008 SANYO DENKI RS3A03 (30A 400 - 750 W) SHAK GANTRY 340 SHAK GANTRY 470
Metal Work 37M2220000	Manufacturer Motor SANYO DENKI R2AA06040FXH11M (400W)		
37M2330000	Motor SANYO DENKI R2AA08075FXH11M (750W)		

The motor must be controlled in such a way as to avoid sudden changes in speed.

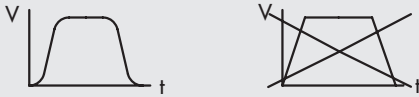

**KEY TO CODES**

CYL	37 TYPE	5	G	1 SIZE	0800 X-AXIS STROKE ◆	0600 Y-AXIS STROKE ◆	1 REDUCTION	1 MOTORS POSITION	200 DRIVE	
	37 Electric actuators	5 SHAK electric axis	G GANTRY	1 Size 340	400 600 800 1000 1200	400 600 800 1000 1200	1 1:5 ratio (X axis) 1:3 ratio (Y axis)	1 Left 2 Right	2 BRUSHLESS motor	0 Standard 0 Standard
				2 Size 470	800 1200 1600 2000 2400	600 1000 1400 1800 2200				

◆ For orderable configurations see the general catalog.

**ACCESSORIES**

**CABLE TRAY CHAIN**

**X AXIS**

Code	Description
095340B0400	Cable tray chain accessory kit, SHAK GANTRY 340 - X400 X-axis
095340B0600	Cable tray chain accessory kit, SHAK GANTRY 340 - X600 X-axis
095340B0800	Cable tray chain accessory kit, SHAK GANTRY 340 - X800 X-axis
095340B1000	Cable tray chain accessory kit, SHAK GANTRY 340 - X1000 X-axis
095340B1200	Cable tray chain accessory kit, SHAK GANTRY 340 - X1200 X-axis

095470B0800	Cable tray chain accessory kit, SHAK GANTRY 470 - X800 X-axis
095470B1200	Cable tray chain accessory kit, SHAK GANTRY 470 - X1200 X-axis
095470B1600	Cable tray chain accessory kit, SHAK GANTRY 470 - X1600 X-axis
095470B2000	Cable tray chain accessory kit, SHAK GANTRY 470 - X2000 X-axis
095470B2400	Cable tray chain accessory kit, SHAK GANTRY 470 - X2400 X-axis

**Y AXIS**

Code	Description
095340A0400	Cable tray chain accessory kit, SHAK 340 - 400
095340A0600	Cable tray chain accessory kit, SHAK 340 - 600
095340A0800	Cable tray chain accessory kit, SHAK 340 - 800
095340A1000	Cable tray chain accessory kit, SHAK 340 - 1000
095340A1200	Cable tray chain accessory kit, SHAK 340 - 1200

095470A0800	Cable tray chain accessory kit, SHAK 470 - 600
095470A1200	Cable tray chain accessory kit, SHAK 470 - 1000
095470A1600	Cable tray chain accessory kit, SHAK 470 - 1400
095470A2000	Cable tray chain accessory kit, SHAK 470 - 1800
095470A2400	Cable tray chain accessory kit, SHAK 470 - 2200

**DRIVES AND CABLE**

See drive code 37D2400008

**OIL**

Code	Description	Volume [ml]
9910490	PARALIQ P 460	80

**SPARE PARTS**

**SHAK GANTRY GEAR BOX**

Codice	Description
37R0541000	X axis gear unit for SHAK GANTRY 340 1:5
37R0543000	X axis gear unit for SHAK GANTRY 470 1:5
37R0341000	Y axis gear unit for SHAK GANTRY 340 1:3
37R0343000	Y axis gear unit for SHAK GANTRY 470 1:3

**SHAK INDUCTIVE SENSOR**

Code	Description
095340A0000	SHAK inductive sensor accessory kit

**ELECTRIC MOTORS**

For SHAK GANTRY 340, please refer to motor code 37M2220000  
For SHAK GANTRY 470, please refer to motor code 37M2330000



## ELECTRIC AXIS SERIES ELEKTRO SVAK



TECHNICAL DATA		
Ambient temperature	°C	from 0 to +40
Maximum relative humidity		90% (no condensate)
Maximum value of duty cycle		100%
Maximum speed without load	m/s	3.5
Maximum acceleration without load	m/s <sup>2</sup>	50
Maximum additional load limit	kg	8
Maximum value of axial force available (with Metal Work motors)	N	300
Maximum axial force supportable by mechanical devices	N	600
Maximum torque applicable to the drive pulley	Nm	5
Standard strokes	mm	200 400 600 800
Repetition accuracy	mm	± 0.05
Toothed belt reduction gear		1:2 ratio
Noise level	dBA	<66
Mounting position		Any
Degree of protection		IP30
Toothed belt pitch	mm	5
Type of belt		PowerGrip® LL GT 5MR 25 FV
Belt elongation at maximum load	mm	
Stroke 200		0.05
Stroke 400		0.06
Stroke 600		0.07
Stroke 800		0.08
Drive shaft pulley pitch diameter	mm	27.06
Stroke per motor rev.	mm/rev	42.5
Homing position sensor		Inductive sensor switch

MASS AND MOMENT OF INERTIA					
Stroke	mm	200	400	600	800
Weight without motor	kg	2.9	3.2	3.5	3.8
Weight of Brushless 200W motor with brake	kg			1.23	
Moving mass	kg	0.8	1.1	1.4	1.7
Reduced inertia at motor (without load)	kg mm <sup>2</sup>	66	80	94	108
Moment of inertia reduced at motor for each kg of load	kg mm <sup>2</sup>			45	

### KEY TO CODES

CYL	37	5	V	0	0	0200	0	4	2	0	0
	TYPE					STROKE ◆		MOTOR	DRIVE	TORQUE	
	37 Electric actuators	5 Belt-driven electric axes	V SVAK	0 STD	0 STD	0200 0400 0600 0800	0 STD	4 BRUSHLESS with BRAKE	2 60 FLANGE	0 0÷0.79 Nm	0 STD

◆ Other strokes on request.

## ACCESSORIES

### OIL

Code	Description	Volume [ml]
9910490	PARALIQ P 460	80

### CABLE TRAY CHAIN

Code	Description
095000C0200	Cable tray chain accessory kit SVAK stroke 200
095000C0400	Cable tray chain accessory kit SVAK stroke 400
095000C0600	Cable tray chain accessory kit SVAK stroke 600
095000C0800	Cable tray chain accessory kit SVAK stroke 800

Note: suitable for connection with SHAK 340 and SHAK 470

## SPARE PARTS

### SHAK INDUCTIVE SENSOR

Code	Description
095340A0000	SHAK inductive sensor accessory kit

### ELECTRIC MOTORS

See motor code 37M4200000

### DRIVES

See drive code 37D2400008

## ELECTRIC AXIS - RODLESS SERIES ELEKTRO SK

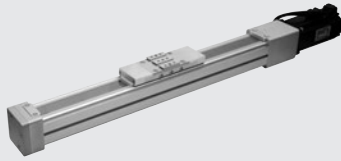

### TECHNICAL DATA

Admissible ambient temperature for STEPPING motor	°C	from -10 to +50
BRUSHLESS motor	°C	from 0 to +40
Maximum relative humidity (IP40)		90% at 40°C; 57% at 50°C (no condensate)
Maximum duty cycle for STEPPING motor		50%
BRUSHLESS motor		100%
Minimum stroke	mm	100
Maximum stroke	mm	1200
Positioning repeatability	mm	± 0.02
Positioning accuracy	mm	± 0.2 **
Uncontrolled impact at the end of stroke		NOT ALLOWED (it provides an extra-stroke minimum 5 mm)
Sensor magnet		YES
Work position		Any
Interface for fixing on carriage		Axial V-Lock / Orthogonal V-Lock / Blank
Noise level	dBA	<66

\*\* indicative average data that gets influenced by various factors such as the stroke, the type of motor, the cylinder version, etc ...

### MECHANICAL FEATURES

Worm screw pitch	mm	4	10
Worm screw diameter	mm		12
Maximum static axial load* (F <sub>0</sub> )	N		2800
Dynamic axial load	N	5200	3600
Maximum number of revs	1/min	3000	4000
Maximum speed (V <sub>max</sub> )	mm/s	200	670
Maximum acceleration without load	m/s <sup>2</sup>		5
Maximum drive torque applicable to the worm screw shank	Nm		5

\* Maximum admissible static load without causing damage.

**N.B.:** For the verification of the linear guide system, please refer to general catalogue. For the verification of the screw, please refer to general catalogue.

### WEIGHTS

Worm screw pitch (p)	mm	4	10
Weight at stroke 0 (excluding the carriage fixing interface)	g	2990	3000
Additional weight each mm of stroke	g		7
Weight of the in-line transmission (without motor)	g		400
Weight of the geared transmission (without motor)	g		600
Moving mass	g		1050

**N.B.:** You get the total weight of a complete cylinder by adding: weight stroke 0 + stroke [mm] x weight for each mm of stroke + weight of the transmission + weight of the motor

### MASS MOMENTS OF INERTIA

Worm screw pitch	mm	4	10
J0 at stroke 0	kg mm <sup>2</sup>	2.7909	5.3633
J1 each metre of stroke	kg mm <sup>2</sup> /m	12.0259	17.3353
J2 each kg of load	kg mm <sup>2</sup> /kg	0.4056	2.5355
J3 in-line transmission	kg mm <sup>2</sup>		5.2
J3 geared transmission	kg mm <sup>2</sup>		19

Total mass moment of inertia Jtot = J0 + J1 · stroke [m] + J2 · load [kg] + J3

### MOTOR-DRIVE COUPLINGS

#### MOTOR CODES

Metal Work	Manufacturer	DRIVES CODES			
		37D1222000	37D1332000	37D1442000	37D1552000
		RTA CSD 94	RTA NDC 96	RTA PLUS A4	RTA PLUS B7
		(4.4A 24÷48VDC)	(6A 24÷75VDC)	(6A 77÷140VDC)	(10A 28÷62VAC) ●

#### STEPPING

37M1120001   Motor SANYO DENKI 103-H7126-6640 (5.6A 75V max)	-	√	-	√ ■
--	---	---	---	-----

#### STEPPING WITH BRAKE

37M5120000   Motor SANYO DENKI 103-H7126-1710.B (4A 75V max)	√	√ ◆	-	√ ■
--	---	-----	---	-----

#### STEPPING WITH BRAKE + ENCODER

37M3230000   Motor B&R 80MPF5.500D114-01 (5A 80V max)	-	√ ◆	√ ■	√ ■
---	---	-----	-----	-----

◆ Important! Limit current

■ Important! Limit current and voltage

● Important! AC drive to continuous voltage VDC VDC = VAC · √2

#### MOTOR CODES

Metal Work	Manufacturer	DRIVES CODES
		37D2300000
		DELTA ASD-A2-0421-M
		(400W)

#### BRUSHLESS

37M2220001   Motor DELTA ECMA-C20604RS (400W)	√
---	---

#### BRUSHLESS WITH BRAKE

37M4220001   Motor DELTA ECMA-C20604SS (400W)	√
---	---



## ELECTRIC AXIS BELT-DRIVEN RODLESS, SERIES ELEKTRO BK



TECHNICAL DATA	VERSION		
	Medium		Heavy
Admissible ambient temperature for STEPPING motor	from -10 to +50		
BRUSHLESS motor	from 0 to +40		
Maximum relative humidity	90% at 40°C; 57% at 50°C (no condensate)		
Maximum duty cycle for STEPPING motor	50%		
BRUSHLESS motor	100%		
Minimum stroke	100		
Maximum stroke	3800		1800
Repeatability	± 0.05		
Positioning accuracy *	± 0.4		
Uncontrolled impact at the end of stroke	NOT ALLOWED (it provides an extra-stroke minimum 5 mm)		
Homing position sensor	Inductive sensors		
Work position	Any		
Noise level	<66		
Type of belt	RPP5 in polyurethane with steel tensioning cables		
Maximum belt extension	0.1%		
Pulley travel/rotation	110		
Pulley pitch diameter	35.01		
Maximum axial force**	800		
Maximum number of revs	3500		3500
Maximum speed (without load)	6		6
Maximum acceleration without load	50		
Maximum driving torque applicable to the pulley	15		

\* Indicative average data that gets influenced by various factors such as the stroke, the type of motor, the cylinder version, etc...

\*\* Maximum load admissible on the belt.

WEIGHTS	VERSION		
	Medium		Heavy
Weight at stroke 0 (drive excluded)	2324		2325
Additional weight each mm of stroke	4		3.7
Weight of standard motors with flange, joint and bolts and nuts			
STEPPING		1560	
BRUSHLESS		1750	
BRUSHLESS with brake		2150	
BRUSHLESS with 1:3 gearbox		2600	
BRUSHLESS with brake + 1:3 gearbox		3000	
BRUSHLESS with 1:5 gearbox		2600	
BRUSHLESS with brake + 1:5 gearbox		3000	

MASS AND MOMENT OF INERTIA	VERSION		
	Medium		Heavy
Moving mass at stroke 0 (Mx)	570		625
Moving mass for each mm of stroke		0.22	
J <sub>0</sub> at stroke 0		72	
J <sub>1</sub> each metre of stroke		68	
J <sub>2</sub> each kg of load		307	
Maximum masses that can be moved VERTICALLY with standard motors:			
STEPPING	1		1
BRUSHLESS	3		3
BRUSHLESS with brake	3		3
BRUSHLESS with gearbox	15		15
BRUSHLESS with brake + gearbox	15		15
Maximum masses that can be moved HORIZONTALLY with standard motors:			
STEPPING	3		3
BRUSHLESS	3		3
BRUSHLESS with brake	3		3
BRUSHLESS with gearbox	15		15
BRUSHLESS with brake + gearbox	15		15

The reduced moment of inertia of total mass at the driving shaft is:  $J_{red} = J_1 \cdot \text{Corsa [m]} + J_2 \cdot (\text{Carico [kg]} + Mx [\text{kg}]) + J_0 \cdot \tau^2 + J_3$

$\tau = 1/u$

$u = \text{Gearing ratio}$

$J_3 = J_{\text{gear ratio}}$

**MOTOR-DRIVE COUPLINGS**

MOTOR CODES		DRIVES CODES		
Metal Work	Manufacturer	37D1222000	37D1332000	37D1552000
		RTA CSD 94	RTA NDC 96	RTA PLUS B7
		(4.4A 24÷48VDC)	(6A 24÷75VDC)	(10A 28÷62VAC) ●
<b>STEPPING</b>			◆	■
37M1230000	Motor SANYO DENKI 103-H7823-1740 (4A 75V max)	√		

◆ Important! Limit current

■ Important! Limit current and voltage

 ● Important! AC drive to continuous voltage  $VDC = VAC \cdot \sqrt{2}$ 

MOTOR CODES		DRIVES CODES		
Metal Work	Manufacturer	37D2300000	DELTA ASD-A2-0421-M	
			(400W)	
<b>BRUSHLESS</b>			√	
37M2220001	Motor DELTA ECMA-C20604RS (400W)			
<b>BRUSHLESS WITH BRAKE</b>			√	
37M4220001	Motor DELTA ECMA-C20604SS (400W)			

The motor must be controlled in such a way as to avoid sudden changes in speed.

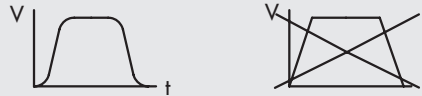
**KEY TO CODES AXIS ELECTRIC (WITHOUT MOTOR)**

CYL	37	4	0	1	1	0300	2	T
	TYPE			SIZE	INTERFACE	STROKE	VERSION	
	37 Electric actuators	4 Electric axis rodless elektro BK	0 STD	1 Size 1	1 Axial V-lock	Medium From 100 to 3800 mm  Heavy From 100 to 1800 mm	2 Medium (steel guide and steel wheels) 3 Heavy (steel guide and pads ball-recirculation)	T Without motor (plugged outlets)

**KEY TO CODES AXIS ELECTRIC MOTOR**

CYL	37	4	0	1	1	0300	2	6	1	2	3	0
	TYPE		SIZE	INTERFACE	STROKE	VERSION	MOTOR POSITION		MOTOR	DRIVE FLANGE	TORQUE	
	37 Electric actuators	4 Electric axis rodless elektro BK	0 STD	1 Size 1	1 Axial V-lock	Medium From 100 to 3800 mm  Heavy From 100 to 1800 mm	2 Medium (steel guide and steel wheels) 3 Heavy (steel guide and pads ball-recirculation)	6 Right 9 Left	1 Stepping 2 Brushless 4 Brushless with BRAKE + Encoder 6 Brushless with 1:3 gearbox 7 Brushless with BRAKE + 1:3 gearbox 8 Brushless with 1:5 gearbox 9 Brushless with BRAKE + 1:5 gearbox	2 60	2 1.2÷2.19 Nm 3 2.2÷3 Nm	0 Base

N.B.: For orderable configurations see the general catalog.

**ACCESSORIES**
**INDUCTION SENSOR Ø 6.5**

Code	Description
W095K030006	PNP Ø 6.5 PNP inductive sensor with LED 2 m
W095K031006	NPN Ø 6.5 NPN inductive sensor with LED 2 m

**CABLE WITH STRAIGHT CONNECTOR FOR Ø 6.5 PUSH-IN INDUCTIVE SENSOR (MOBILE INSTALLATION)**

Code	Description
02400A0100	M8 female 3 PIN HIGH FLEX CL6 connector with cable L = 1 m
02400A0250	M8 female 3 PIN HIGH FLEX CL6 connector with cable L = 2.5 m
02400A0500	M8 female 3 PIN HIGH FLEX CL6 connector with cable L = 5 m
02400A1000	M8 female 3 PIN HIGH FLEX CL6 connector with cable L = 10 m

Note: Mobile laying cable, class 6 according to IEC 60228

**CABLE WITH 90° CONNECTOR FOR Ø 6.5 PUSH-IN INDUCTIVE SENSOR (MOBILE INSTALLATION)**

Code	Description
02400B0100	M8 female 3 PIN 90° HIGH FLEX CL6 connector with cable L = 1 m
02400B0250	M8 female 3 PIN 90° HIGH FLEX CL6 connector with cable L = 2.5 m
02400B0500	M8 female 3 PIN 90° HIGH FLEX CL6 connector with cable L = 5 m
02400B1000	M8 female 3 PIN 90° HIGH FLEX CL6 connector with cable L = 10 m

Note: Mobile laying cable, class 6 according to IEC 60228

**QUICK-FIT INDUCTIVE SENSOR Ø 6.5**

Code	Description
W095K030009	PNP Ø 6.5 inductive sensor with push-in LED

**BRACKET FOR INDUCTION SENSOR Ø 6.5**

Code	Description
095BK1R001	Proximity switch support for BK

**CONNECTION JOINT KIT FOR BK**

Code	Description
095BK1R011	Connection joint kit for BK, centre distance 475 mm
095BK1R012	Connection joint kit for BK, centre distance 675 mm
095BK1R013	Connection joint kit for BK, centre distance 875 mm
095BK1R014	Connection joint kit for BK, centre distance 1075 mm
095BK1R015	Connection joint kit for BK, centre distance 1275 mm
095BK1R016	Connection joint kit for BK, centre distance 1475 mm

 Max revs: 2000 rpm.  
Max torque: 25 Nm (hole Ø 12 mm)

**SPARE PARTS**
**BK GEARBOXES**

Code	Description
37R0341000	Gearbox MP053 1:3
37R0541000	Gearbox MP053 1:5

**ELECTRIC MOTORS**

See page 68

**DRIVES**

See page 73

## ELECTRIC MOTORS



### TECHNICAL FEATURES OF ELECTRIC STEPPING MOTORS

TECHNICAL DATA		MOTOR 37M1110000
Motor type		STEPPING
Seal torque (with motor stopped)	Nm	<b>0.8</b>
Coupling flange		<b>NEMA 23</b>
Base step angle		1.8°±0.09°
Bipolar current	A	4
Resistance	Ω	0.41
Inductance	mH	1.6
Bipolar retaining torque	Nm	1.1
Rotor inertia	kgmm <sup>2</sup>	21
Theoretical acceleration	rad · s <sup>-2</sup>	50000
Back E.M.F.	V/krpm	20
Mass	kg	0.65
Degree of protection		IP40

TECHNICAL DATA		MOTOR 37M1120000
Motor type		STEPPING
Seal torque (with motor stopped)	Nm	<b>1.2</b>
Coupling flange		<b>NEMA 23</b>
Base step angle		1.8°±0.09°
Bipolar current	A	4
Resistance	Ω	0.48
Inductance	mH	2.2
Bipolar retaining torque	Nm	1.65
Rotor inertia	kgmm <sup>2</sup>	36
Theoretical acceleration	rad · s <sup>-2</sup>	45800
Back E.M.F.	V/krpm	31
Mass	kg	1
Degree of protection		IP40

TECHNICAL DATA		MOTOR 37M1120001
Motor type		STEPPING
Seal torque (with motor stopped)	Nm	<b>1.2</b>
Coupling flange		<b>NEMA 23</b>
Base step angle		1.8°±0.09°
Bipolar current	A	5.6
Resistance	Ω	0.3
Inductance	mH	0.85
Bipolar retaining torque	Nm	1.65
Rotor inertia	kgmm <sup>2</sup>	36
Theoretical acceleration	rad · s <sup>-2</sup>	45800
Back E.M.F.	V/krpm	23
Mass	kg	1
Degree of protection		IP43

TECHNICAL DATA		MOTOR 37M1230000
Motor type		STEPPING
Nominal torque	Nm	<b>2.2</b>
Coupling flange (square)	mm	<b>60</b>
Base step angle		1.8°±0.09°
Bipolar current	A	4
Resistance	Ω	0.65
Inductance	mH	2.4
Bipolar holding torque	Nm	3
Rotor inertia	kgmm <sup>2</sup>	84
Theoretical acceleration	rad · s <sup>-2</sup>	35700
Back E.M.F.	V/krpm	75
Mass	kg	1.4
Degree of protection		IP40

TECHNICAL DATA		MOTOR 37M1430000
Motor type		STEPPING
Seal torque (with motor stopped)	Nm	<b>2.4</b>
Coupling flange		<b>NEMA 34</b>
Base step angle		1.8°±0.09°
Bipolar current	A	6
Resistance	Ω	0.3
Inductance	mH	1.65
Bipolar retaining torque	Nm	3
Rotor inertia	kgmm <sup>2</sup>	145
Theoretical acceleration	rad · s <sup>-2</sup>	20600
Back E.M.F.	V/krpm	50
Mass	kg	1.5
Degree of protection		IP43

TECHNICAL DATA		MOTOR 37M1440000
Motor type		STEPPING
Seal torque (with motor stopped)	Nm	<b>4.2</b>
Coupling flange		<b>NEMA 34</b>
Base step angle		1.8°±0.09°
Bipolar current	A	6
Resistance	Ω	0.35
Inductance	mH	2.7
Bipolar retaining torque	Nm	5.6
Rotor inertia	kgmm <sup>2</sup>	290
Theoretical acceleration	rad · s <sup>-2</sup>	19300
Back E.M.F.	V/krpm	93
Mass	kg	2.5
Degree of protection		IP43

TECHNICAL DATA		MOTOR 37M1450000
Motor type		STEPPING
Seal torque (with motor stopped)	Nm	<b>6.7</b>
Coupling flange		<b>NEMA 34</b>
Base step angle		1.8°±0.09°
Bipolar current	A	6
Resistance	Ω	0.46
Inductance	mH	3.8
Bipolar retaining torque	Nm	9.2
Rotor inertia	kgmm <sup>2</sup>	450
Theoretical acceleration	rad · s <sup>-2</sup>	20500
Back E.M.F.	V/krpm	161
Mass	kg	4
Certifications		UL, CSA, CE, RoHS
Tension d'isolement		250VAC (350VDC)
Degree of protection		IP43 - F

TECHNICAL DATA		MOTOR 37M1470000
Motor type		STEPPING
Nominal torque	Nm	<b>9.3</b>
Coupling flange		<b>NEMA 34</b>
Base step angle		1.8°
Bipolar current	A	10
Resistance	Ω	0.24
Inductance	mH	1.6
Bipolar holding torque	Nm	13.6
Rotor inertia	kgmm <sup>2</sup>	392
Mass	kg	4.2
Degree of protection		IP40
Power cable for stepping motors with brake, 3 metres		<b>37C1330000</b>
Power cable for stepping motors with brake, 5 metres		<b>37C1350000</b>

TECHNICAL DATA		MOTOR 37M1890000
Motor type		STEPPING
Nominal torque	Nm	<b>17.5</b>
Coupling flange		<b>NEMA 42</b>
Base step angle		1.8°±0.09°
Bipolar current	A	6
Resistance	Ω	0.63
Inductance	mH	8
Bipolar holding torque	Nm	24.6
Rotor inertia	kgmm <sup>2</sup>	2200
Theoretical acceleration	rad · s <sup>-2</sup>	11100
Back E.M.F.	V/krpm	410
Mass	kg	10
Degree of protection		IP43





TECHNICAL DATA	MOTOR 37M3450000	TECHNICAL DATA	MOTOR 37M3470000
Motor type	STEPPING with BRAKE + ENCODER	Motor type	STEPPING with BRAKE + ENCODER
Nominal torque	Nm <b>6.3</b>	Nominal torque	Nm <b>9.3</b>
Coupling flange	<b>NEMA 34</b>	Coupling flange	<b>NEMA 34</b>
Base step angle	<b>1.8°</b>	Base step angle	<b>1.8°</b>
Bipolar current	A <b>10</b>	Bipolar current	A <b>10</b>
Resistance	$\Omega$ <b>0.2</b>	Resistance	$\Omega$ <b>0.24</b>
Inductance	mH <b>1.4</b>	Inductance	mH <b>1.6</b>
Bipolar holding torque	Nm <b>9.5</b>	Bipolar holding torque	Nm <b>13.6</b>
Rotor inertia	kgmm <sup>2</sup> <b>261</b>	Rotor inertia	kgmm <sup>2</sup> <b>392</b>
Mass	kg <b>3.7</b>	Mass	kg <b>4.2</b>
Degree of protection	<b>IP65</b>	Degree of protection	<b>IP65</b>
Encoder cable for stepping motors with brake, 3 metres	<b>37C1230000</b>	Encoder cable for stepping motors with brake, 3 metres	<b>37C1230000</b>
Power cable for stepping motors with brake, 3 metres	<b>37C1330000</b>	Power cable for stepping motors with brake, 3 metres	<b>37C1330000</b>
Encoder cable for stepping motors with brake, 5 metres	<b>37C1250000</b>	Encoder cable for stepping motors with brake, 5 metres	<b>37C1250000</b>
Power cable for stepping motors with brake, 5 metres	<b>37C1350000</b>	Power cable for stepping motors with brake, 5 metres	<b>37C1350000</b>
<b>ENCODER</b>			
Number of outputs	<b>3 A / B / R</b>	Number of outputs	<b>3 A / B / R</b>
Resolution	positions per rev <b>1024</b>	Resolution	positions per rev <b>1024</b>
Supply voltage	VDC <b>18 - 30</b>	Supply voltage	VDC <b>18 - 30</b>
<b>BRAKE</b>			
Supply voltage	VDC <b>24 +6% / -10%</b>	Supply voltage	VDC <b>24 +6% / -10%</b>
Braking torque	Nm <b>9</b>	Braking torque	Nm <b>9</b>
Power consumption	W <b>18</b>	Power consumption	W <b>18</b>
Connecting time	ms <b>7</b>	Connecting time	ms <b>7</b>
Delay time	ms <b>2</b>	Delay time	ms <b>2</b>
Disconnection time	ms <b>40</b>	Disconnection time	ms <b>40</b>

**TECHNICAL FEATURES OF ELECTRIC BRUSHLESS MOTORS (SANYO DENKI)**

TECHNICAL DATA	MOTOR 37M2200000	TECHNICAL DATA	MOTOR 37M2220000
Motor type	BRUSHLESS	Motor type	BRUSHLESS
Nominal torque	Nm <b>0.64</b>	Nominal torque	Nm <b>1.27</b>
Coupling flange (square)	mm <b>60</b>	Coupling flange (square)	mm <b>60</b>
Nominal power	W <b>200</b>	Nominal power	W <b>400</b>
Nominal speed	rpm <b>3000</b>	Nominal speed	rpm <b>3000</b>
Maximum speed	rpm <b>6000</b>	Maximum speed	rpm <b>6000</b>
Stall torque	Nm <b>0.686</b>	Stall torque	Nm <b>1.37</b>
Maximum torque	Nm <b>2.2</b>	Maximum torque	Nm <b>4.8</b>
Rotor inertia	kgmm <sup>2</sup> <b>21.9</b>	Rotor inertia	kgmm <sup>2</sup> <b>41.2</b>
Mass	kg <b>0.84</b>	Mass	kg <b>1.3</b>
Encoder	pulse/rev <b>131072 (17 bit)</b>	Encoder	pulse/rev <b>131072 (17 bit)</b>
Degree of protection	<b>IP65</b>	Degree of protection	<b>IP65</b>
Drive code	<b>37D2400008</b>	Drive code	<b>37D2400008</b>
Connecting cable:			
Brushless motor-drive, 3 metres	<b>37C2130000</b>	Brushless motor-drive, 3 metres	<b>37C2130000</b>
Brushless motor-drive-encoder, 3 metres	<b>37C2230000</b>	Brushless motor-drive-encoder, 3 metres	<b>37C2230000</b>
Brushless motor-drive, dynamic cable, 3 metres	<b>37C2130003</b>	Brushless motor-drive, dynamic cable, 3 metres	<b>37C2130003</b>
Brushless motor-drive-encoder, dynamic cable, 3 metres	<b>37C2230003</b>	Brushless motor-drive-encoder, dynamic cable, 3 metres	<b>37C2230003</b>
Brushless motor-drive, 5 metres	<b>37C2150000</b>	Brushless motor-drive, 5 metres	<b>37C2150000</b>
Brushless motor-drive-encoder, 5 metres	<b>37C2250000</b>	Brushless motor-drive-encoder, 5 metres	<b>37C2250000</b>
Brushless motor-drive, dynamic cable, 5 metres	<b>37C2150003</b>	Brushless motor-drive, dynamic cable, 5 metres	<b>37C2150003</b>
Brushless motor-drive-encoder, dynamic cable, 5 metres	<b>37C2250003</b>	Brushless motor-drive-encoder, dynamic cable, 5 metres	<b>37C2250003</b>
Brushless motor-drive, dynamic cable, 10 metres	<b>37C2110003</b>	Brushless motor-drive, dynamic cable, 10 metres	<b>37C2110003</b>
Brushless motor-drive-encoder, dynamic cable, 10 metres	<b>37C2210003</b>	Brushless motor-drive-encoder, dynamic cable, 10 metres	<b>37C2210003</b>
<b>TECHNICAL DATA</b>			
Motor type	BRUSHLESS	Motor type	BRUSHLESS
Nominal torque	Nm <b>2.39</b>	Nominal torque	Nm <b>3.18</b>
Coupling flange (square)	mm <b>80</b>	Coupling flange (square)	mm <b>86</b>
Nominal power	W <b>750</b>	Nominal power	W <b>1000</b>
Nominal speed	rpm <b>3000</b>	Nominal speed	rpm <b>3000</b>
Maximum speed	rpm <b>6000</b>	Maximum speed	rpm <b>3000</b>
Stall torque	Nm <b>2.55</b>	Stall torque	Nm <b>3.92</b>
Maximum torque	Nm <b>7.1</b>	Maximum torque	Nm <b>11.6</b>
Rotor inertia	kgmm <sup>2</sup> <b>182</b>	Rotor inertia	kgmm <sup>2</sup> <b>238.3</b>
Mass	kg <b>2.6</b>	Mass	kg <b>3.5</b>
Encoder	pulse/rev <b>131072 (17 bit)</b>	Encoder	pulse/rev <b>131072 (17 bit)</b>
Degree of protection	<b>IP65</b>	Degree of protection	<b>IP65</b>
Drive code	<b>37D2400008</b>	Drive code	<b>37D2400008</b>
Connecting cable:			
Brushless motor-drive, 3 metres	<b>37C2130000</b>	Brushless motor-drive, 3 metres	<b>37C2130000</b>
Brushless motor-drive-encoder, 3 metres	<b>37C2230000</b>	Brushless motor-drive-encoder, 3 metres	<b>37C2230000</b>
Brushless motor-drive, dynamic cable, 3 metres	<b>37C2130003</b>	Brushless motor-drive, dynamic cable, 3 metres	<b>37C2130003</b>
Brushless motor-drive-encoder, dynamic cable, 3 metres	<b>37C2230003</b>	Brushless motor-drive-encoder, dynamic cable, 3 metres	<b>37C2230003</b>
Brushless motor-drive, 5 metres	<b>37C2150000</b>	Brushless motor-drive, 5 metres	<b>37C2150000</b>
Brushless motor-drive-encoder, 5 metres	<b>37C2250000</b>	Brushless motor-drive-encoder, 5 metres	<b>37C2250000</b>
Brushless motor-drive, dynamic cable, 5 metres	<b>37C2150003</b>	Brushless motor-drive, dynamic cable, 5 metres	<b>37C2150003</b>
Brushless motor-drive-encoder, dynamic cable, 5 metres	<b>37C2250003</b>	Brushless motor-drive-encoder, dynamic cable, 5 metres	<b>37C2250003</b>
Brushless motor-drive, dynamic cable, 10 metres	<b>37C2110003</b>	Brushless motor-drive, dynamic cable, 10 metres	<b>37C2110003</b>
Brushless motor-drive-encoder, dynamic cable, 10 metres	<b>37C2210003</b>	Brushless motor-drive-encoder, dynamic cable, 10 metres	<b>37C2210003</b>



TECHNICAL DATA	MOTOR 37M4330000	TECHNICAL DATA	MOTOR 37M4540000
Motor type	BRUSHLESS with BRAKE	Motor type	BRUSHLESS with BRAKE
Nominal torque	Nm 2.39	Nominal torque	Nm 3.18
Coupling flange (square)	mm 80	Coupling flange (square)	mm 86
Nominal power	W 750	Nominal power	W 1000
Nominal speed	rpm 3000	Nominal speed	rpm 3000
Maximum speed	rpm 6000	Maximum speed	rpm 3000
Stall torque	Nm 2.55	Stall torque	Nm 3.92
Maximum torque	Nm 8.5	Maximum torque	Nm 11.6
Rotor inertia	kgmm <sup>2</sup> 207	Rotor inertia	kgmm <sup>2</sup> 272.6
Mass	kg 2.19	Mass	kg 4.34
Encoder	pulse/rev 131072 (17 bit)	Encoder	pulse/rev 131072 (17 bit)
Degree of protection	IP65	Degree of protection	IP65
Drive code	37D2400008	Drive code	37D2400008
Connecting cable:		Connecting cable:	
Brushless motor-drive, 3 metres	37C2130005	Brushless motor-drive, 3 metres	37C2130005
Brushless motor-drive-encoder, 3 metres	37C2230005	Brushless motor-drive-encoder, 3 metres	37C2230005
Brushless motor-drive, dynamic cable, 3 metres	37C2130004	Brushless motor-drive, dynamic cable, 3 metres	37C2130004
Brushless motor-drive-encoder, dynamic cable, 3 metres	37C2230004	Brushless motor-drive-encoder, dynamic cable, 3 metres	37C2230004
Brushless motor-brake, dynamic cable, 3 metres	37C2330000	Brushless motor-brake, dynamic cable, 3 metres	37C2330000
Brushless motor-drive, 5 metres	37C2150005	Brushless motor-drive, 5 metres	37C2150005
Brushless motor-drive-encoder, 5 metres	37C2250005	Brushless motor-drive-encoder, 5 metres	37C2250005
Brushless motor-drive, dynamic cable, 5 metres	37C2150004	Brushless motor-drive, dynamic cable, 5 metres	37C2150004
Brushless motor-drive-encoder, dynamic cable, 5 metres	37C2250006	Brushless motor-drive-encoder, dynamic cable, 5 metres	37C2250006
Brushless motor-brake, dynamic cable, 5 metres	37C2350000	Brushless motor-brake, dynamic cable, 5 metres	37C2350000
Brushless motor-drive, dynamic cable, 10 metres	37C2100004	Brushless motor-drive, dynamic cable, 10 metres	37C2100004
Brushless motor-drive-encoder, dynamic cable, 10 metres	37C2200004	Brushless motor-drive-encoder, dynamic cable, 10 metres	37C2200004
Brushless motor-brake, dynamic cable, 10 metres	37C2310000	Brushless motor-brake, dynamic cable, 10 metres	37C2310000
<b>BRAKE</b>		<b>BRAKE</b>	
Supply voltage	VDC 24 ±10%	Supply voltage	VDC 24 ±10%
Braking torque static	Nm 2.55 min	Braking torque static	Nm 3.92 min

**TECHNICAL FEATURES OF ELECTRIC BRUSHLESS MOTOR WITH BRAKE (DELTA)**

TECHNICAL DATA	MOTOR 37M4200001	TECHNICAL DATA	MOTOR 37M4770000
Motor type	BRUSHLESS with BRAKE	Motor type	BRUSHLESS with BRAKE
Nominal torque	Nm 0.64	Nominal torque	Nm 9.55
Coupling flange (square)	mm 60	Coupling flange (square)	mm 130
Nominal power	W 200	Nominal power	W 3000
Nominal speed	rpm 3000	Nominal speed	rpm 3000
Maximum speed	rpm 5000	Maximum speed	rpm 4500
Stall torque	Nm 0.64	Stall torque	Nm 9.55
Maximum torque	Nm 1.92	Maximum torque	Nm 28.65
Rotor inertia	kgmm <sup>2</sup> 19.2	Rotor inertia	kgmm <sup>2</sup> 1400
Mass	kg 1.5	Mass	kg 9.2
Encoder	imp./giro 131072 (17 bit)	Encoder	pulse/rev 1048576 (20 bit)
Degree of protection	IP40	Degree of protection	IP65
Drive code	37D2200001	Drive code	37D2600001
Connecting cable:		Connecting cable:	
Brushless motor-drive with brake, 3 metres	37C2730000	Brushless motor-drive-encoder, 3 metres	37C3230001
Brushless motor-drive-encoder, 3 metres	37C2230001	Brushless motor-drive with brake, 3 metres	37C3730000
Brushless motor-drive with brake, 5 metres	37C2750000	Brushless motor-drive-encoder, 5 metres	37C3250001
Brushless motor-drive-encoder, 5 metres	37C2250001	Brushless motor-drive with brake, 5 metres	37C3750000
<b>BRAKE</b>		<b>BRAKE</b>	
Supply voltage	VDC 24 ±10%	Supply voltage	VDC 24 ±10%
Braking torque static	Nm 1.3	Braking torque static	Nm 10
Absorption	W 6.5		

TECHNICAL DATA	MOTOR 37M4220001	NOTE
Motor type	BRUSHLESS with BRAKE	
Nominal torque	Nm 1.27	
Coupling flange (square)	mm 60	
Nominal power	W 400	
Nominal speed	rpm 3000	
Maximum speed	rpm 5000	
Stall torque	Nm 1.27	
Maximum torque	Nm 3.82	
Rotor inertia	kgmm <sup>2</sup> 30	
Mass	kg 2	
Encoder	pulse/rev 131072 (17 bit)	
Degree of protection	IP40	
Drive code	37D2300000	
Connecting cable:		
Brushless motor-drive with brake, 3 metres	37C2730000	
Brushless motor-drive-encoder, 3 metres	37C2230001	
Brushless motor-drive with brake dynamic cable, 3 metres	37C2730001	
Brushless motor-drive, dynamic cable, 3 metres	37C2130002	
Brushless motor-drive with brake, 5 metres	37C2750000	
Brushless motor-drive-encoder, 5 metres	37C2250001	
Brushless motor-drive with brake dynamic cable, 5 metres	37C2750001	
Brushless motor-drive-encoder, dynamic cable, 5 metres	37C2250002	
Brushless motor-drive with brake dynamic cable, 10 metres	37C2700001	
Brushless motor-drive-encoder, dynamic cable, 10 metres	37C2200003	
<b>BRAKE</b>		
Supply voltage	VDC 24 ±10%	
Braking torque static	Nm 1.3	
Absorption	W 6.5	

## PROGRAMMING UNIT e.motion



TECHNICAL DATA	
Code	37D0000000
Stand-alone motion programming unit for motors-drives with a STEP/DIRECTION interface, type	Metal box
Dimensions	mm 148 x 99 x 30
Weight	g 460
Connectors	Screw type, pull-out
Temperature range	0 to 50 °C – relative humidity 10-90%, non-condensing
Degree of protection	IP 20
Voltage	24VDC ±10%
Communication interface	Serial USB port for connection to PC
Configuration/programming/debug and diagnosis software	MW POS in Windows® environment
Dedicated signals	Encoder input (A + B + Z), Line Driver type STEP/DIRECTION outputs, with frequency up to 100 kHz, Line Driver type
Digital inputs	16, optoisolati, configurabili PNP o NPN, liberamente programmabili
Analogue inputs	2, from 0 to 10V, freely programmable
Digital outputs	15, Line Driver type, PNP, freely programmable
Analogue outputs	1, from 0 to 10V, freely programmable
Controls available	<ul style="list-style-type: none"> <li>- Search for home position on the end stop, up against the stop, on the end stop and the encoder mark, up against the stop and the encoder zero mark;</li> <li>- Positioning in relative or absolute mode;</li> <li>- Force control;</li> <li>- Closed-loop motion control and step-loss control in the case of STEPPING motors with encoder;</li> <li>- Integrated brake control in the case of motors with a brake;</li> <li>- Possible control of multiple separate drivers in parallel for concurrent applications;</li> <li>- Complementary and logical instructions for complex work cycles, such as: timings; repetitions; analogue and digital I/O control; variables control; tests</li> </ul>

## ACCESSORIES

### BRACKET TO FIT ONTO OMEGA BAR

Code	Description	Weight [g]
095000M000	Bracket to fix e.motion board onto Omega bar (DIN EN 50022)	30

### CABLE USB

Code	Description	Weight [g]
37C0030000	3 m cable for USB 2.0 male A-B connector with ferrite core, for connecting the e.motion board to a PC	150

### CABLE FOR BRUSHLESS DRIVERS

Code	Description	Weight [g]
37C2510000	Cable for connecting the e.motion board to Sanyo Denki RS_A0_driver	130
37C2510001	Cable for connecting the e.motion board to Delta ASDA A2, 1 m	130

## PROGRAMMABLE STEPPING MOTOR DRIVE - e.drive



TECHNICAL DATA		
Code		<b>37D1332002</b>
Motion control logic power supply	VDC	24
Drive power supply	VDC	24 to 55
Motor phase peak current	A	1 to 6
Temperature range	°C	-20 to 40
Relative humidity (without condensation)	%	5 to 85
Bipolar motor inductance (1.8° angle)	mH	1 to 12
Dimensions	mm	148 x 99 x 50.5
Weight	g	790
Degree of protection		IP20
Communication interface		Serial USB port for connection to PC
Configuration/programming/debug and diagnosis software		MW DRIVE in Windows® environment
Dedicated signals		Encoder input (A + B + Z), 5V line driver or 24V Push-Pull/Open collector
Digital inputs		14
Digital outputs		7
Analogue inputs		2, from 0 to 10V, freely programmable
Analogue outputs		1, from 0 to 10V
Controls available		<ul style="list-style-type: none"> <li>- Can be used with motors with a 1.8° base angle, 200 pulses/rev.;</li> <li>- Step Mode settable in various ways: Full Step, Half Step, 1/4, 1/8, 1/16 of step;</li> <li>- Integrated linear position transducer by connecting directly to the analogue output;</li> <li>- Automatic 60% reduction of the current supplied with motor stopped;</li> <li>- Possible dynamic regulation of the current supplied via cycle software instructions, for energy-saving purposes;</li> <li>- Home position search on limit switch, mechanical stop, encoder limit switch and zero mark, encoder mechanical stop and zero mark;</li> <li>- Positioning in relative or absolute mode;</li> <li>- Closed-loop motion control and step-loss control in the case of STEPPING motors with an encoder;</li> <li>- Integrated, automatic brake control via dedicated digital output in the case of motors with a brake;</li> <li>- Complementary and logical instructions for complex work cycles, such as: timings; variables control; test; analogue and digital I/O control</li> </ul>

## ACCESSORIES

### BRACKET MOUNTING ON OMEGA BAR (DIN EN 50022)

Code	Description	Weight [g]
<b>095000M000</b>	Bracket mounting e.motion / e.drive on Omega bar (DIN EN 50022)	30

### CABLE USB

Code	Description	Weight [g]
<b>37C0030000</b>	Cable for USB 2.0 male A-B connector with ferrite core, for connecting the e.motion / e.drive board to a PC, 3 m	150

## DRIVERS FOR STEPPING MOTORS

### 4.4A - 48VDC DRIVE FOR STEPPING MOTORS, CODE 37D1222000

	Drive code		<b>37D1222000</b>
	Type of STEPPING motor drive		Metal box
	Dimensions	mm	90 x 99 x 21
	Connectors		Screw type, pull-out
	Onboard power supply		NO
	Control		Step and direction
	Operating voltage range	VDC	24 - 48
	Current range	A	2.6 - 4.4
	Current values selected via a dip-switch		8
	Pulses per rev values selected by dip-switch	1/U	400, 800, 1600, 3200
	Automatic current reduction with motor off		YES (50%)
	Type of inputs		Pull-up or Pull-down, settable
	Protections		Maximum and minimum voltage. Motor output short-circuiting. Thermal protection. Electronic damping circuit for maximum control of noise and vibration.



**6A 75V DC DRIVE TECHNICAL DATA FOR STEPPING MOTORS, CODE 37D1332000**

Drive code		<b>37D1332000</b>
Type of STEPPING motor drive		Metal box
Dimensions	mm	110 x 108 x 34
Connectors		Screw type, pull-out
Onboard power supply		NO
Control		Step and direction
Operating voltage range	VDC	24 - 75
Current range	A	1.9 - 6
Current values selected via a dip-switch		8
Pulses per rev values selected by dip-switch	pulse/rev	400, 500, 800, 1000, 1600, 2000, 3200, 4000
Automatic current reduction with motor off		YES (50%)
Type of inputs		Opto-isolated
Protections		Maximum and minimum voltage. Motor output short-circuiting. Thermal protection. Electronic damping circuit for maximum control of noise and vibration.

**6A 140V DC DRIVE FOR STEPPING MOTORS, CODE: 37D1442000  
10A 62V DC DRIVE FOR STEPPING MOTORS, CODE: 37D1552000**

Drive code		<b>37D1442000</b>		<b>37D1552000</b>
Type of STEPPING motor drive			Metal box	
Dimensions	mm		152 x 129 x 46	
Connectors			Screw type, pull-out	
Onboard power supply			NO	
Control			Step and direction	
Operating voltage range	VDC	77 - 140 VDC		28 - 62 VAC
Current range	A	1.9 - 6		3 - 10
Current values selected via a dip-switch			8	
Pulses per rev values selected by dip-switch	pulse/rev	400, 500, 800, 1000, 1600, 2000, 3200, 4000		400, 500, 800, 1000, 1600, 2000, 3200, 4000
Automatic current reduction with motor off		YES (50%)		YES (50%)
Type of inputs			Opto-isolated	
Protections			Maximum and minimum voltage. Motor output short-circuiting. Thermal protection. Electronic damping circuit for maximum control of noise and vibration.	

**6A - 110 - 230VAC DRIVE FOR STEPPING MOTORS, CODE 37D1362001**

Drive code		<b>37D1362001</b>
Type of STEPPING motor drive		Metal box
Dimensions	mm	180 x 173 x 53
Connectors		Screw type, pull-out
Onboard power supply		NO
Control		Step and direction
Operating voltage range	VAC	Single-phase 110 - 230
Current range	A	3.4 - 6
Motor output stage		High-efficiency CHOPPER with IGBT final stage output
Current values selected via a dip-switch		8
Pulses per rev values selected by dip-switch	pulse/rev	400, 500, 800, 1000, 1600, 2000, 3200, 4000
Automatic current reduction with motor off		YES
Type of inputs		Opto-isolated
Protections		Maximum and minimum voltage. Motor output short-circuiting. Thermal protection. Electronic damping circuit for maximum control of noise and vibration.
Standards		UL and CSA
Other features		Possibility to switch off motor current via an external logic control device. Electronic sound-damping circuit for enhanced reduced noise and mechanical vibration at low and medium speed. Storage and reporting of the intervention of protection circuits. It must be coupled with STEPPING motors designed for high-voltage rating and flanges not below 86 mm. No need for forced ventilation.
Suitable for motors code		<b>37M1890000</b>

**ACCESSORIES**
**POWER CABLE FOR MOTOR WITH BRAKE**

Code	Description
37C1330000	Power cable for stepping motor with brake, 3 metres
37C1350000	Power cable for stepping motor with brake, 5 metres

**ENCODER CABLE**

Code	Description
37C1230000	Encoder cable for stepping motors with brake, 3 metres
37C1250000	Encoder cable for stepping motors with brake, 5 metres

## DRIVES FOR BRUSHLESS MOTORS

ACTUATORS

DRIVES FOR BRUSHLESS MOTORS



### 30A DRIVE FOR BRUSHLESS MOTORS, CODE 37D2400008

Drive code		<b>37D2400008</b>
Type of drive for BRUSHLESS motors		Metal box
Dimensions	mm	50 x 160 x 130
Power connectors and motor power		Plug-type 3M
Encoder connectors and signals		Plug-type 3M
Max output current	A	30
Motor output stage		IGBT, PWM control, sinusoidal current
Power voltage		Single-phase or three-phase (user configurable) 200-230VAC (+10%, -15%) 50/60 Hz (± 3 Hz)
Logic voltage		Single-phase 200-230VAC (+10%, -15%) 50/60 Hz (± 3 Hz)
Control		With analogue signal (proportional to speed and torque). Pulse-train (clock + direction; forward + backward pulse; 90° phase difference) 8 inputs and 8 outputs, user configurable.
		In the event of pulse-train command, the control system outputs should be the Line Driver type. If the outputs are the open-collector type, you can use a 37D2000000 board, which is sold separately (see accessories).
		YES
Auto-tuning		Mini USB for settings and monitoring via a personal computer.
Communication interface		Integrated against overloads, input extra-voltages, incorporated filters for suppressing the system's own resonance frequencies
Protections		CE, UL and CSA.
Standards		5-digit display and programming keypad.
Other features		Integrated closed-loop system with position, speed and torque control modes. Instant changeover option: position + speed; position + torque; speed + torque. Automatic dynamic braking circuit in a alarm and power-off conditions. Connector for external braking resistance (optional). Configuration and control software.

## ACCESSORIES FOR BRUSHLESS MOTOR DRIVES

### ENCODER CABLE

Code	Description
37C2230005	Brushless motor-drive-encoder connecting cable 3 m
37C2250005	Brushless motor-drive-encoder connecting cable 5 m
37C2230004	Brushless motor-drive-encoder connecting dynamic cable, 3 m
37C2250006	Brushless motor-drive-encoder connecting dynamic cable, 5 m
37C2210004	Brushless motor-drive-encoder connecting dynamic cable, 10 m

### MOTOR POWER CABLE

Code	Description
37C2130005	Brushless motor-drive connecting cable 3 m
37C2150005	Brushless motor-drive connecting cable 5 m
37C2130004	Brushless motor-drive connecting dynamic cable, 3 m
37C2150004	Brushless motor-drive connecting dynamic cable, 5 m
37C2110004	Brushless motor-drive connecting dynamic cable, 10 m

### BRAKE CABLE

Code	Description
37C2330000	Brushless motor-brake connecting dynamic cable, 3 m
37C2350000	Brushless motor-brake connecting dynamic cable, 5 m
37C2310000	Brushless motor-brake connecting dynamic cable, 10 m

### LINE-DRIVER INTERFACE BOARD

Code	Description
37D2000000	BRINT.A line-driver interface board

### EXTERNAL BRAKING RESISTANCES

Code	Description	For drive code
37D2R00000	220W 50 Ω braking resistance	37D2400008

Under certain operating conditions, such as sudden deceleration with high inertial load, it may be necessary to dissipate externally the reverse energy generated by the motor. The drive indicates this requirement via a specific alarm. Excess energy is dissipated externally via a braking resistance.

**DRIVE FOR 200W BRUSHLESS MOTOR, CODE 37D2200001**  
**DRIVE FOR 400W BRUSHLESS MOTOR, CODE 37D2300000**



		37D2200001	37D2300000
Drive code		200	400
Nominal power	W		
Type of drive for BRUSHLESS motors		Metal box	
Dimensions	mm	170 x 173 x 45	
Power connectors and motor power		Screw type, pull-out	
Encoder connectors and signals		Plug-type 3M	
Max output current	A	4.65	7.80
Motor output stage		IGBT, PWM control, sinusoidal current	
Power voltage		Single-phase or three-phase (user configurable) 200VAC-230VAC (+10%, -15%) 50/60 Hz (± 3 Hz)	
Logic voltage		Single-phase 200-230VAC (+10%, -15%) 50/60 Hz (± 3 Hz)	
Control		With analogue signal (proportional to speed and torque).	
		Pulse-train (clock + direction; forward + backward pulse; 90° phase difference)	
		fieldbus with "CANopen" communication protocol	
		8 inputs and 5 outputs, user configurable.	
		In the event of pulse-train command, the control system outputs should be the Line Driver type.	
		If the outputs are the open-collector type, you can use a 37D2000000 board, which is sold separately (see accessories).	
Auto-tuning		Yes	
Communication interface		Serial USB port for settings and monitoring via a personal computer	
Protections		Integrated against overloads, input extra-voltages, incorporated filters for suppressing the system's own resonance frequencies.	
Standards		CE and UL	
Other features		5-digit display and programming keypad.	
		Integrated closed-loop system with position, speed and torque control modes.	
		Control mode: position + speed; position + torque; speed + torque.	
		Circuito automatico di frenatura dinamica in condizioni di allarme o power-off.	
		Connector for external braking resistance (optional).	
		Configuration and control software (optional).	
Suitable for motors code		37M2200001 - 37M4200001	37M2220001 - 37M4220001

## ACCESSORIES

### ENCODER CABLE

Code	Description
37C2230001	200W-750W Brushless motor-drive-encoder connecting cable, 3 m
37C2250001	200W-750W Brushless motor-drive-encoder connecting cable, 5 m
37C2230002	200W-750W Brushless motor-drive-encoder connecting dynamic cable, 3 metres
37C2250002	200W-750W Brushless motor-drive-encoder connecting dynamic cable, 5 metres
37C2200003	200W-750W Brushless motor-drive-encoder connecting dynamic cable, 10 metres

### MOTOR POWER CABLE

Code	Description
37C2130001	200W-750W Brushless motor-drive connecting cable, 3 m
37C2150001	200W-750W Brushless motor-drive connecting cable, 5 m
37C2130002	200W-750W Brushless motor-drive connecting dynamic cable, 3 metres, mobile laying
37C2150002	200W-750W Brushless motor-drive connecting dynamic cable, 5 metres
37C2100003	200W-750W Brushless motor-brake connecting dynamic cable, 5 metres

### MOTOR POWER CABLE + BRAKE

Code	Description
37C2730000	200W-750W Brushless motor drive connecting cable + brake, 3 m
37C2750000	200W-750W Brushless motor drive connecting cable + brake, 5 m
37C2730001	200W-750W Brushless motor-brake connecting dynamic cable, 3 metres
37C2750001	200W-750W Brushless motor-brake connecting dynamic cable, 5 metres
37C2700001	200W-750W Brushless motor-brake connecting dynamic cable, 10 metres

**DRIVE FOR 3kW BRUSHLESS MOTOR, CODE 37D2600001**



Drive code	37D2600001
Type of drive for BRUSHLESS motors	Metal box
Dimensions	245 x 205.4 x 123
Power connectors and motor power	Screw type, pull-out
Encoder connectors and signals	Plug-type 3M
Max output current	33.32
Motor output stage	IGBT, PWM control, sinusoidal current
Power voltage	Three-phase from 380VAC to 480VAC $\pm 10\%$ 50/60 Hz ( $\pm 3$ Hz)
Logic voltage	24VDC $\pm 10\%$
Control	With analogue signal (proportional to speed and torque). Pulse-train (clock + direction; forward + backward pulse; 90° phase difference) fieldbus with "CANopen" communication protocol 8 inputs and 5 outputs, user configurable In the event of pulse-train command, the control system outputs should be the Line Driver type. If the outputs are the open-collector type, you can use a 37D2000000 board, which is sold separately (see accessories).
Auto-tuning	Yes
Communication interface	Serial USB port for settings and monitoring via a personal computer
Protections	Integrated against overloads, input extra-voltages, incorporated filters for suppressing the system's own resonance frequencies.
Standards	CE and UL
Other features	5-digit display and programming keypad. Integrated closed-loop system with position, speed and torque control modes. Control mode: position + speed; position + torque; speed + torque. Circuito automatico di frenatura dinamica in condizioni di allarme o power-off. Connector for external braking resistance (optional). Configuration and control software (optional).
Suitable for motors code	<b>37M2770000 - 37M4770000</b>

**ACCESSORIES**

**CAVO ENCODER**

Code	Description
37C3230001	3kW Brushless motor-drive-encoder connecting cable, 3 m
37C3250001	3kW Brushless motor-drive-encoder connecting cable, 5 m

**MOTOR POWER CABLE**

Code	Description
37C3130001	3kW Brushless motor-drive connecting cable, 3 m
37C3150001	3kW Brushless motor-drive connecting cable, 5 m

**MOTOR POWER CABLE + BRAKE**

Code	Description
37C3730000	3kW brushless motor drive connecting cable + brake, 3 m
37C3750000	3kW brushless motor drive connecting cable + brake, 5 m

**LINE-DRIVER INTERFACE BOARD**

Code	Description
37D2000000	BRINT.A line driver interface board

**EXTERNAL BRAKING RESISTANCES**

Code	Description	For drive code
37D2R00000	220W 50 $\Omega$ braking resistance	37D2200001 - 37D2300000
37D2R00004	400W 40 $\Omega$ braking resistance	37D2600001

Under certain operating conditions, such as sudden deceleration with high inertial load, it may be necessary to dissipate externally the reverse energy generated by the motor. The drive indicates this requirement via a specific alarm. Excess energy is dissipated externally via a braking resistance.

## MAGNETIC SENSORS

### RETRACTABLE SENSOR SQUARE TYPE

For ISO 6432 - ISO 15552 - ISO 15552 ELEKTRO - COMPACT - COMPACT GUIDED - LINER - SSCY - RODLESS - RODLESS V-Lock - RODLESS ELEKTRO SK - HIDRAULIC BRAKE - GRIPPERS P1, P1K, P4, P4K, P7, P7K, P9, P9K - ROTARY R1, R3, R3K - SLIDES S10 (Ø 16 ÷ 30), S11 (Ø 16 ÷ 30), S12, DAPK

Code	Description
T7	
W095414	REED sensor, T7 SQUARE, 2 wires 2.5 m
W095415	REED sensor, T7 SQUARE, 2 wires 5 m
W095416	REED sensor, T7 SQUARE, 2 wires 10 m
W09541C	REED sensor, T7 SQUARE, 2 wires 2.5 m robotics
W095411	REED sensor, T7 SQUARE, 2 wires 300 mm M8 robotics
W095434	HALL sensor, T7 SQUARE, 3 wires 2.5 m
W095435	HALL sensor, T7 SQUARE, 3 wires 5 m
W09543C	HALL sensor, T7 SQUARE, 3 wires 2.5 m robotics
W095431	HALL sensor, T7 SQUARE, 3 wires 300 mm M8 robotics

T8 ATEX	
W0955A9	HALL sensor, T8 SQUARE, 3 wires ATEX 2 m SH.OV. robotics

T8 (for corrosive environments)	
W0952125396	HALL sensor, T8 SQUARE, 3 wires 2 m HCR
W0952129394	HALL sensor, T8 SQUARE, 3 wires 300 mm M8 HCR

**Note: Not to be used with rodless cylinders Ø 25 having "V" guide.**  
For this type of cylinder use only the HS version of the oval type.



TECHNICAL DATA	RZT7	MRZT7	ATEX MZT8	HCR
Type of contact	REED	HALL EFFECT	HALL EFFECT	HALL EFFECT
Switch	N.O.	N.O.	N.O.	N.O.
Supply voltage (Ub)	V	10 to 30 DC	10 to 26 DC	10 to 30 DC
Power	W	3 (6 di picco)	≤ 1.7	-
Voltage variation	-	≤ 10% of Ub	≤ 10% of Ub	-
Voltage drop at Imax	V	≤ 3.5	≤ 2.2	≤ 2.2
Input current	mA	≤ 8	≤ 10	≤ 10
Output current	mA	≤ 100	≤ 50	≤ 200
Switching frequency	Hz	≤ 400	1000	≤ 1000
Short-circuit protection	-	Yes	Yes	Yes
Over-voltage suppression	-	-	-	Yes
Polarity inversion protection	-	Yes	Yes	Yes
EMC	EN 60 947-5-2	EN 60 947-5-2	EN 60 947-5-2	EN 60 947-5-2
LED display	Yellow	Yellow	Yellow	Yellow
Magnetic sensitivity	mT	2.1 - 3.5	2.4 - 3.6	2.4 - 3.6
Repeatability	mT	≤ 0.1	≤ 0.1 (Ub and to fixed)	≤ 0.1
Degree of protection (EN 60529)	IP 67	IP 67	IP 67	IP 68 (M8) - IP69K 2m
Vibration and shock resistance	30 g, 11 ms, 10 ÷ 55 Hz, 1 mm			
Operating life	10 <sup>7</sup> impulses	10 <sup>9</sup> impulses	10 <sup>9</sup> impulses	-
Temperature range	°C			
with polyurethane cable	-30 to 80 (static installation) / -20 to 80 (dynamic installation)		-	-30 to 80 (static installation)
with PVC cable	-30 to 80 (static installation) / -5 to 80 (dynamic installation)		-20 to 50	-
Sensor capsule material	PA	PA	PA	PA12
2.5 m/2 m connecting cable	PVC; 2 x 0.12 mm <sup>2</sup>	PVC; 3 x 0.12 mm <sup>2</sup>	PVC; 3 x 0.14 mm <sup>2</sup>	PUR; 3 x 0.14 mm <sup>2</sup>
Connecting cable with M8x1	Polyurethane; 2 x 0.14 mm <sup>2</sup>	Polyurethane; 3 x 0.14 mm <sup>2</sup>	-	PUR; 3 x 0.14 mm <sup>2</sup>
Wire NO.	2	3	3	3
Category ATEX	-	-	II 3G Ex nA IIC T4 Gc X II 3D Ex tc IIIC T135°C Dc IP67 X	-
Certifications	CE	CE	CE $\Xi$	CE cULus
<b>ROBOTICS VERSIONS</b>				
Angle of twist	±270° / 10 cm			
No. of cycles torsion	> 350.000 (±270° / 0.1 mm)			
Bending cycles	> 5 Mio (bending radius 29 mm)			
Maximum acceleration	m/s <sup>2</sup> max 5			
Maximum traverse speed at 5 m horizontal path	m/min max 200			

#### WIRING DIAGRAM

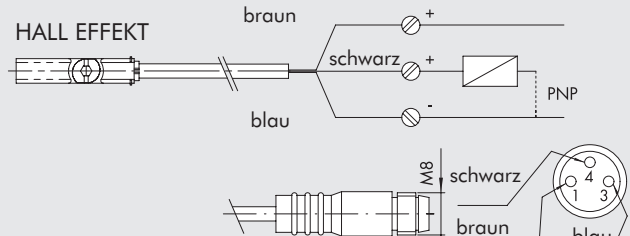
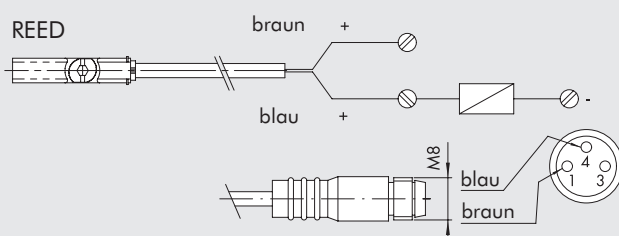

## RETRACTABLE SENSOR OVAL TYPE

For ISO 6432, ISO 15552, ISO 15552 Ø 160-200-250-320, ISO 15552 ELEKTRO, COMPACT, COMPACT GUIDED CMPG, COMPACT GUIDED CMPGK, LINER, ROUND, RODLESS, RODLESS V-LOCK, HIDRAULIC BRAKE, GRIPPERS P1 - P1K - P4 (Ø 12-30) - P4K - P7 - P7K - P8 - P9 - P9K, ROTARY R1, R3, R3K, DAPK, SLIDES S10 (Ø 16-30), S11 (Ø 16-30), S12, DAPK



ACTUATORS

SENSORS

Code	Description	ID Number
W0952025390	HALL N.O. sensor, OVAL, 2.5 m	CE32MP
W0952225390	HALL N.O. sensor, OVAL, 2.5 m robotics	CE32MPR
W0952029394	HALL N.O. sensor, OVAL, 300 mm M8 robotics	CE3M8P
W0952022180	REED N.O. sensor, OVAL, 2.5 m	CR22M
W0952222180	REED N.O. sensor, OVAL, 2.5 m robotics	CR22RM
W0952028184	REED N.O. sensor, OVAL, 300 mm M8 robotics	CR2M8

W0952025500*	HALL N.O. sensor, OVAL, HS 2.5 m	-
W0952029504*	HALL N.O. sensor, OVAL, HS 300 mm M8	-
W0952022500*	REED N.O. sensor, OVAL, HS 2.5 m	-
W0952128184*	REED N.O. sensor, OVAL, HS 300 mm M8	-

\* For use on the rodless cylinder "V" guide Ø25 or when standard sensors do not detect the magnet, e.g. near metal masses.

Note: Individually packed

### TECHNICAL DATA

	REED	HALL EFFECT
Type of contact	N.O.	N.O.
Switch	-	PNP
Supply voltage (U <sub>b</sub> )	V 10 to 30 AC/DC	10 to 30 DC
Power	W 3 (peak valve = 6)	3
Voltage variation	-	≤ 10% of U <sub>b</sub>
Voltage drop	V -	≤ 2
Input current	mA -	≤ 10
Output current	mA ≤ 100	≤ 100
Switching frequency	Hz ≤ 400	≤ 5000
Short-circuit protection	-	Yes
Over-voltage suppression	-	Yes
Polarity inversion protection	-	Yes
EMC	EN 60 947-5-2	EN 60 947-5-2
LED display	Yellow	Yellow
Magnetic sensitivity	2.8 mT ± 25% 1.9 mT ± 20% (for HS)	2.8 mT ± 25% 2.1 mT ± 20% (for HS)
Repeatability	≤ 0.1 mT	≤ 0.1 mT
Degree of protection (EN 60529)	IP 67	IP 67
Vibration and shock resistance	30 g, 11 ms, 10 to 55 Hz, 1 mm	30 g, 11 ms, 10 to 55 Hz, 1 mm
Operating life	10 <sup>7</sup> impulses	10 <sup>9</sup> impulses
Temperature range	°C -25 to +75	-25 to +75
Sensor capsule material	PA66 + PA6I/6T	PA66 + PA6I/6T
2.5 m/2 m connecting cable	PVC; 2 x 0.12 mm <sup>2</sup>	PVC; 3 x 0.14 mm <sup>2</sup>
Connecting cable with M8x1	Polyurethane; 2 x 0.14 mm <sup>2</sup>	Polyurethane; 3 x 0.14 mm <sup>2</sup>
Wire NO.	2	3
Certifications		
<b>ROBOTICS VERSIONS</b>		
2.5 m / 300 mm connecting cables	Polyurethane; 2 x 0.14 mm <sup>2</sup>	Polyurethane; 3 x 0.14 mm <sup>2</sup>
Cable test conditions:	bending torsion	> 5.000.000 cycles (bending radius 29 mm) > 350.000 cycles (± 270°/0.1 mm)

### WIRING DIAGRAM

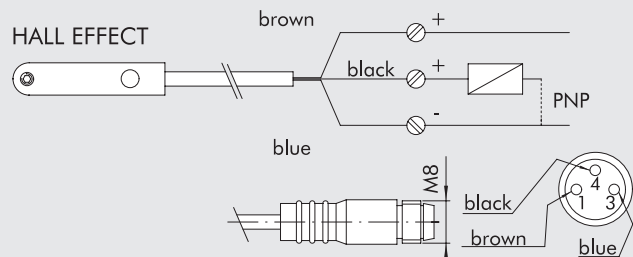
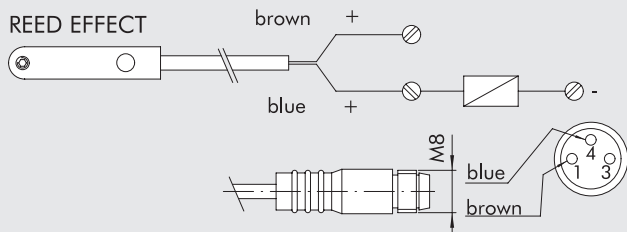



## SENSOR Ø 4

PER PINZE P2 - P2K - P4 (Ø 10-30) - P3 - P3K - P4K - P12 - P12K - GPLK - ROTANTE R2 - SLITTE S10 (Ø 12) S11 (Ø 12) - S13 - S14K

Code	Description
W0950044180	Sensor REED 2 wires 2.5 m robotics
W0950045390	Sensor HALL 3 wires 2.5 m robotics



TECHNICAL DATA		REED	HALL EFFECT
Type of contact		N.O.	N.O.
Switch		-	PNP
Supply voltage (U <sub>b</sub> )	V	3 to 30 AC/DC	6 to 30 DC
Power (resistive load)	W	6	6
Voltage drop	V	< 3	< 1
Input current	mA	-	≤ 10
Output current	mA	≤ 200	≤ 200
Switching frequency	Hz	≤ 500	≤ 200000
Short-circuit protection		-	-
Over-voltage suppression		-	-
Polarity inversion protection		-	Yes
EMC		EN 60 947-5-2	EN 60 947-5-2
LED display		Yellow	Yellow
Magnetic sensitivity		2.3 mT ± 10%	2.8 mT ± 25%
Repeatability		≤ 0.1 mT	≤ 0.1 mT
Degree of protection (EN 60529)		IP 67	IP 67
Operating life		10 <sup>7</sup> impulses	10 <sup>9</sup> impulses
Temperature range	°C	-10 to +60	-10 to +60
Sensor capsule material		PET + AISI 303	PET + AISI 303
2.5 m connecting cable		Polyurethane; 2 x 0.13 mm <sup>2</sup>	Polyurethane; 3 x 0.13 mm <sup>2</sup>
Wire NO.		2	3
Certifications		CE cUL <sub>us</sub>	CE cUL <sub>us</sub>
Cable test conditions:	bending torsion	> 5.000.000 cycles (bending radius 28 mm) > 350.000 cycles (± 270°/0.1 mm)	

### WIRING DIAGRAM

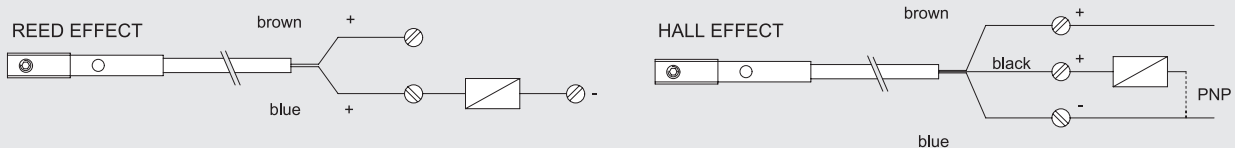

## INDUCTION SENSOR Ø 4

FOR GRIPPER P8

Code	Description
W0950037391	Induction sensor Ø 4 mm PNP-NO-2 m

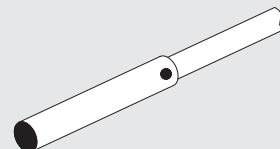

## SENSOR SERIES DSM

FOR ISO 15552, ISO 15552 Ø 160 to 200-250-320, ISO 6432  
TWIN-ROD, ROUND, ROTARY R1, HYDRAULIC BRAKE,  
ELEKTRO ROUND DC



Code	Description
W0950000201	Acc. REED sensor DSM2-C525 HS
W0950000222	Acc. E. HALL PNP sensor DSM3-N225
W0950000232	Acc. E. HALL NPN sensor DSM3-M225

TECHNICAL DATA SERIE DSM	REED		HALL EFFECT	
	Type of contact	N.O.		N.O. PNP
Switch	-		-	
Supply voltage (U <sub>b</sub> )	V	3 to 250 AC/DC	6 to 30 DC	
Power	W	10	6	
Voltage drop	V	< 3	< 1	
Output current	mA	1500	250	
Switching frequency	Hz	500	> 2000	
Polarity inversion protection		Yes	Yes	
EMC		EN 60 947-5-2	EN 60 947-5-2	
LED display		Yellow	Yellow	
Degree of protection (EN 60529)		IP 67	IP 67	
Operating life		10 <sup>7</sup> impulses	10 <sup>9</sup> impulses	
Temperature range	°C	-10 to +70	-10 to +70	
Sensor capsule material		PA; AISI 303; OT 63	PA; AISI 303; OT 63	
2.5 m connecting cable		PVC; 2 x 0.25 mm <sup>2</sup>	PVC; 3 x 0.25 mm <sup>2</sup>	
Wire NO.		2	3	
Certifications		<b>CE</b>	<b>CE</b>	

## SENSOR SERIES DCB

FOR SSCY

Code	Version	Bore	Model
W0950000252	Reed connector + bracket - CB	12 to 100	REED sensor DCB 2C-425
W0950000253	Hall PNP connector + bracket - CB	12 to 100	E HALL PNP sensor DCB3-N225
W0950014360	Hall NPN connector + bracket - CB	12 to 100	E HALL NPN sensor DCB3-M225



TECHNICAL DATA	REED + VARISTOR + LED 2 WIRES		HALL VERSION PNP/NPN 3 WIRES	
	REED + VARISTOR + LED NO		HALL EFFECT NO PNP/NPN	
Type				
Contact				
Max AC/DC voltage	V	3 to 48 (DC); 3 to 110 (AC)	6 to 30 (DC)	
Max current at 25°C	mA	300	250	
Power with inductive load	VA	8	-	
Power with resistive load	Watt	15	6	
Switch-on time	m sec	0.5	0.8	
Switch-off time	m sec	0.1	3	
Switch-on point	Gauss	110	15	
Switch-off point	Gauss	60	8	
Operating life		10 <sup>7</sup> impulses	10 <sup>9</sup> impulses	
Contact resistance		0.1	-	
Cable length	m	2.5	2.5	
Cable cross section	mm <sup>2</sup>	0.35	0.35	
Cable material		Soft PVC	Soft PVC	

### WIRING DIAGRAM SERIES DSM AND DCB SENSORS

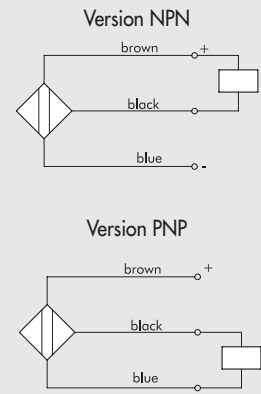
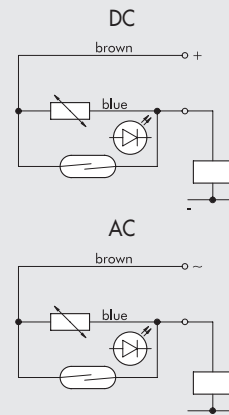

## ACCESSORIES

**SENSOR CIRCLIP MOD. DSW**  
FOR ISO 6432 STD AND TP



Code	Ø	Model
W0950000608	8	BEF-KHZ-RT-08F23
W0950000610	10	BEF-KHZ-RT-10F23
W0950000612	12	BEF-KHZ-RT-12F23
W0950000616	16	BEF-KHZ-RT-16F23
W0950000620	20	BEF-KHZ-RT-20F23
W0950000625	25	BEF-KHZ-RT-25F23

**UNIVERSAL CIRCLIP FOR ISO 6432 STD, TP, STAINLESS STEEL ROUND CYLINDER, STAINLESS STEEL ISO 6432**



Code	Ø	Model
W0950001103	8 to 63	Universal bracket

**MATERIAL**  
Bracket: stainless steel  
Sensor holder: plastic

**SENSOR CIRCLIP MOD. DXF**  
FOR ALUMINIUM BARREL



Code	Ø	Model
<b>FOR ISO 6432 STD</b>		
W0950000508	8	Bracket DXF - 09
W0950000510	10	Bracket DXF - 11
W0950000512	12	Bracket DXF - 13
W0950000516	16	Bracket DXF - 17
W0950000520	20	Bracket DXF - 21
W0950000525	25	Bracket DXF - 26

**FOR ROUND CYLINDER**

W0950000132	32	Bracket DXF - 36
W0950000140	40	Bracket DXF - 40
W0950000150	50	Bracket DXF - 50

**FOR ISO 6432 TP**

W0950000108	8	Bracket DXF 12- 8
W0950000110	10	Bracket DXF 14-10
W0950000112	12	Bracket DXF 16-12
W0950000116	16	Bracket DXF 20-16
W0950000120	20	Bracket DXF 24-20
W0950000125	25	Bracket DXF 29-25

**SENSOR SUPPORT BRACKET**  
FOR ISO 15552 Ø 160-200  
(WITH ROUND BARREL)



Code	Description
0951602093	Bracket 160-200

**SENSOR SUPPORT BRACKETS**  
FOR SENSORS DSM (32 to 125)  
FOR ISO 15552 STD, ISO 15552 250-320, SERIES 3, RORAY R1, INTEGRATED HYDRAULIC BRAKE, TWIN- ROD

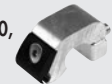

Code	Ø	Description
W0950000711	32-40	Bracket D.32-40 DST 80
W0950000712	50-63	Bracket D.50-63 DST 81
W0950000713	80-100	Bracket D.80-100-125 DST 82
W0950000715	160	Bracket ST250
W0950000716	200	Bracket ST320

**SENSOR SUPPORT BRACKETS**  
FOR SENSORS SQUARE TYPE AND OVAL TYPE FOR ISO 15552 (32 ÷ 125), ROTARY ACTUATOR R1



Code	Ø	Description
W0950001711	32-40	Bracket D.32-40
W0950001712	50-63	Bracket D.50-63
W0950001713	80÷125	Bracket D.80-100-125

**ADAPTOR FOR RETRACTABLE SENSOR FOR BRACKET DST/ST**



Code	Description
W0950001001	Adaptor DSS005 for DST/ST brackets

**ADAPTOR ASSEMBLY DIAGRAM**

- ISO 15552 cylinder with Serie STD or Serie 3 barrel
- Sensor bracket mod. DST (Ø 32 to 200)
- Adaptor
- Retractable sensor "oval type"

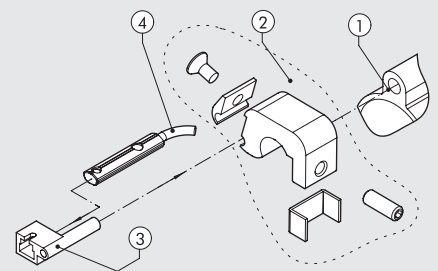

**ADAPTER FOR RETRACTABLE SENSOR FOR SSCY CYLINDERS**

**ASSEMBLY DIAGRAM**

- SSCY cylinder
- Sensor adapter for SSCY cylinders
- Retractable sensor "oval type"
- Retractable sensor "square type"
- Grub screw for fixing adapter on profile

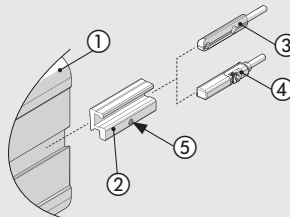

Code	Ø	Description
W0950001801	Ø 12 to 100	Sensor Adapter for SSC cylinders

**USE SENSORS FOR CYLINDERS ISO 6432**

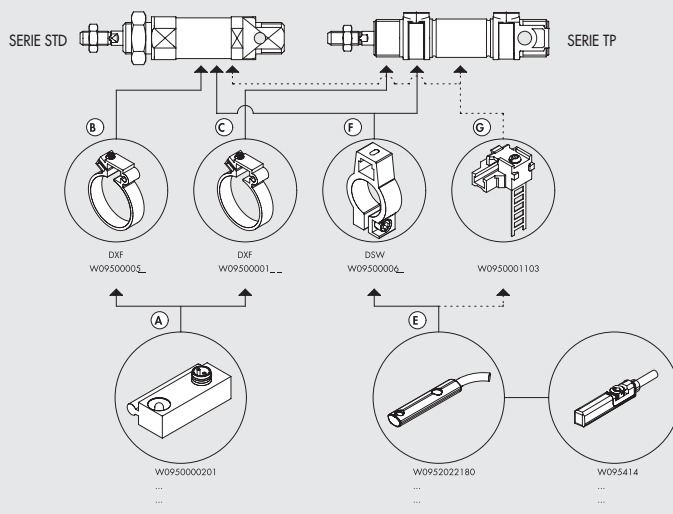

## ACCESSORIES T-SLOT

**BAR FOR GROOVING**



Code	Description
W0950000160	Bar for grooving L = 500 mm

**SLOTTED FIXING PLATE**



Code	Description
0950003001	M4 T-slotted fixing plate
0950003002	M3 T-slotted fixing plate

**SLOTTED FIXINGPLATE**



Code	Description
0950003000	Fixing block

## POSITION SENSOR

Position sensor LTS



Position sensor LTL



Position sensor LTE



TECHNICAL DATA		LTS	LTL	LTE
Measuring length	mm	from 0 to 256 (± 1 mm)	from 257 to 503 (± 1 mm)	150 - 200 - 250 - 300 - 350 - 400 - 450 - 500
Electrical connection		M8x1 - 4 pin	M8x1 - 4 pin	M8x1 - 4 pin
Electromagnetic compatibility in accordance with standard		EN 60947-5-7	EN 60947-5-7	-
Sample time	ms	1	1.15	1 for measuring lengths up to 600 mm, 1.5 for greater lengths
IEC 60068-2-6 shock test		30 g, 11 ms	30 g, 11 ms	-
IEC 60068-2-6 vibration test		10 Hz ... 55 Hz, 1 mm	10 Hz ... 55 Hz, 1 mm	-
DIN IEC68T2-27 shock test		-	-	100 g - 11 ms - single stroke
DIN IEC68T2-6 vibration test		-	-	12g / 10 ... 2000 Hz
Maximum displacement speed	m/s	< 3	< 3	≤ 10
Maximum acceleration	m/s <sup>2</sup>	-	-	≤ 100
Resolution	mm	0.03 % FSR (≥ 0.05 mm)	0.03 % FSR (≥ 0.06 mm)	Endless
Repeatability	mm	0.06 % FSR (≥ 0.1 mm)	0.06 % FSR (≥ 0.1 mm)	-
Linearity	mm	0.3*	0.5	≤ ±0.2% f.s. (min ±1 mm)
Maximum repeatability	mm	-	-	≤ 0.05
Maximum hysteresis	mm	-	-	≤ 0.2
Operating temperature	°C	-20 to +70	-20 to +70	0 to +50
Storage temperature	°C	-	-	-40 to +100
Temperature coefficient		-	-	≤ ±0.01% f.s./°C (min 0.015 mm/°C)
Index of protection		IP 67	IP 65, IP 67	IP 65
Protection class		III	III	-
Spam		-	-	9 VDC ± 100 mV max
Voltage	V	15 to 30	15 to 30	24 ± 20%
Black current (without load)	mA	< 25	< 35	-
Analogue output (voltage)	V	0 to 10	0 to 10	-
Out-of-range analogue output	V	11	11	-
Analogue output (current)	mA	4 to 20	4 to 20	-
Out-of-range analogue output	mA	3	3	-
Max. load resistance (current output)	Ω	500	< 500	-
Min. load resistance (voltage output)	Ω	2000	> 2000	-
Electrical zero	V	-	-	0.8
Maximum ripple voltage		-	-	1 Vpp
Output current consumption	mA	-	-	35
Output load	kΩ	-	-	≥ 10
Max. output value	V	-	-	12
Alarm output value	V	-	-	10.5
Electrical insulation	V	-	-	50
Polarity inversion protection		YES	YES	YES
Short-circuit protection		YES	YES	YES
Overload protection		YES	-	YES

\* In some applications, linearity may be higher than the value indicated.

### ORDERING CODES POSITION SENSOR LTS

Code	Description
W0950000470	LTS-032 position sensor with M8 4-PIN 0.3 m connector
W0950000471	LTS-064 position sensor with M8 4-PIN 0.3 m connector
W0950000472	LTS-096 position sensor with M8 4-PIN 0.3 m connector
W0950000473	LTS-128 position sensor with M8 4-PIN 0.3 m connector
W0950000474	LTS-160 position sensor with M8 4-PIN 0.3 m connector
W0950000475	LTS-192 position sensor with M8 4-PIN 0.3 m connector
W0950000476	LTS-224 position sensor with M8 4-PIN 0.3 m connector
W0950000477	LTS-256 position sensor with M8 4-PIN 0.3 m connector

### ORDERING CODES POSITION SENSOR LTL

Code	Description
W0950000478	LTL-287 Position sensor with M8 4-PIN 0.3 m connector
W0950000479	LTL-359 Position sensor with M8 4-PIN 0.3 m connector
W0950000480	LTL-431 Position sensor with M8 4-PIN 0.3 m connector
W0950000481	LTL-503 Position sensor with M8 4-PIN 0.3 m connector

### ORDERING CODES POSITION SENSOR LTE

Code	Description Metal Work	Description GEFRAN
W0950000482	LTE-150 position sensor	ONPP-A-S-0150-N
W0950000483	LTE-200 position sensor	ONPP-A-S-0200-N
W0950000484	LTE-250 position sensor	ONPP-A-S-0250-N
W0950000485	LTE-300 position sensor	ONPP-A-S-0300-N
W0950000486	LTE-350 position sensor	ONPP-A-S-0350-N
W0950000487	LTE-400 position sensor	ONPP-A-S-0400-N
W0950000488	LTE-450 position sensor	ONPP-A-S-0450-N
W0950000489	LTE-500 position sensor	ONPP-A-S-0500-N

**ACCESSORIES**

**T-SLOT BRACKET  
POSITION SENSOR LTL**



Code	Description
<b>W0950000721</b>	Bracket for mounting LTL on cylinder with T-slot
Bracket for fixing the LTL position sensor in the T-slot of the actuator.	

**SLOTTED FIXING PLATE WITH INSERTION FROM ABOVE  
POSITION SENSOR LTE/LTL**

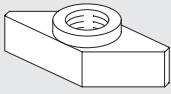

Code	Description	Weight [g]
<b>W0950000469</b>	M4 T-slotted fixing plate	4
Note: 2 items plus 2 M4x14 screws per pack		
Materials: Stainless steel plate and screws		

**STRAIGHT M8 CONNECTORS  
POSITION SENSOR LTS/LTL/LTE**

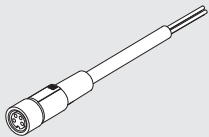

Code	Description
<b>0240009100</b>	M8 4-pin female, straight connector with shielded cable L = 2 m
<b>0240009101</b>	M8 4-pin female, straight connector with shielded cable L = 5 m

**90° M8 CONNECTORS  
POSITION SENSOR LTS/LTL/LTE**

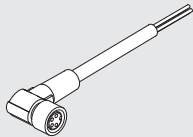

Code	Description
<b>0240009102</b>	M8 4-pin female, 90° connector with shielded cable L = 2 m
<b>0240009103</b>	M8 4-pin female, 90° connector with shielded cable L = 5 m

**SENSOR TESTER**



TECHNICAL DATA	
Container material	PA 6.6 blue
Degree of protection	IP00
Connections	M8 and M12 plug-socket type with 40 cm cable
Additional connections	3 terminals for wire connection
Power supply	9V DC (battery type 6LR61)
Internal voltage	15V DC
Green light	tester switched on
Yellow light	sensor in operation
Red light	battery flat

Code	Description
<b>W0950060000</b>	Sensor tester

**NOTE**

---

---

---

---

---

---

---

---

---

---

---

---

---

---

---

---

---

---

---

---

---

---

---

---

---

---

## MINIVALVES, MECHANICALLY AND HAND OPERATED SERIES VME



### TECHNICAL DATA

Valve fitting port		Push-in fitting for pipe diam. 4 and M5 (axial or side)
Fluid		Filtered air without lubrication; lubrication, if used, must be continuous
Type		With poppet
Versions		Mechanical and manual
Operators:		With Plunger – Plunger for wall-mounting – Roller lever – Unidirectional roller lever
• mechanical		Depending on the type of actuation panel selected
• manual		
Operating pressure	bar	0,5 to 10
Operating temperature range	°C	-10° to +60
Nominal diameter	mm	2,5
Conductance C	Nl/min · bar	16,5
Critical ratio b	bar/bar	0,03
Flow rate at 6 Bar ΔP 0,5 Bar	Nl/min	35
Flow rate at 6 Bar ΔP 1 Bar	Nl/min	60
Actuation force – Plunger at 6 Bar	N	8
Recommended lubricant		ISO and UNI FD22
Installation		In any position

VALVES

MINIVALVES, MECHANICALLY AND HAND OPERATED SERIES VME

### PLUNGER 3/2 NO - AXIAL FITTINGS

Symbol	Code	Description
	W3501000101	VME1-10 NO Ø 4
	W3501000110	VME1-16 NO M5

### PLUNGER 3/2 NC - AXIAL FITTINGS

Symbol	Code	Description
	W3501000100	VME1-01 NC Ø 4
	W3501000111	VME1-11 NC M5

### PLUNGER FOR WALL MOUNTING, 3/2 NC - AXIAL FITTINGS

Symbol	Code	Description
	W3501000400	VME1-04 NC Ø 4
	W3501000411	VME1-14 NC M5

### UNIDIRECTIONAL ROLLER LEVER, 3/2 NC - AXIAL FITTINGS

Symbol	Code	Description
	W3501000300	VME1-03 NC Ø 4
	W3501000311	VME1-13 NC M5

### ROLLER LEVER, 3/2 NO - AXIAL FITTINGS

Symbol	Code	Description
	W3501000201	VME1-05 NO Ø 4
	W3501000210	VME1-15 NO M5

### ROLLER LEVER, 3/2 NC - AXIAL FITTINGS

Symbol	Code	Description
	W3501000200	VME1-02 NC Ø 4
	W3501000211	VME1-12 NC M5

### PLUNGER 3/2 NO - SIDE FITTINGS

Symbol	Code	Description
	W3501001100	VME2-00 NO Ø 4
	W3501001110	VME2-10 NO M5

### PLUNGER 3/2 NC - SIDE FITTINGS

Symbol	Code	Description
	W3501001101	VME2-01 NC Ø 4
	W3501001111	VME2-11 NC M5

### PLUNGER FOR WALL MOUNTING, 3/2 NC - SIDE FITTINGS

Symbol	Code	Description
	W3501001401	VME2-04 NC Ø 4
	W3501001411	VME2-14 NC M5

### UNIDIRECTIONAL ROLLER LEVER, 3/2 NC - SIDE FITTINGS

Symbol	Code	Description
	W3501001301	VME2-03 NC Ø 4
	W3501001311	VME2-13 NC M5

### ROLLER LEVER, 3/2 NO - SIDE FITTINGS

Symbol	Code	Description
	W3501001200	VME2-05 NO Ø 4
	W3501001210	VME2-15 NO M5

### ROLLER LEVER, 3/2 NC - SIDE FITTINGS

Symbol	Code	Description
	W3501001201	VME2-02 NC Ø 4
	W3501001211	VME2-12 NC M5



## MANUAL VME VALVES – ASSEMBLY DIAGRAM

### NOTES:

- For 5/2 pneumatic operation, assemble a 3/2 NC plunger valve and a 3/2 NO one on the adapter.
- For 5/3 pneumatic operation with open centres, assemble two 3/2 NC plunger valves on the adapter.
- For 5/3 pneumatic operation with pressure centres, assemble two 3/2 NO plunger valves on the adapter.

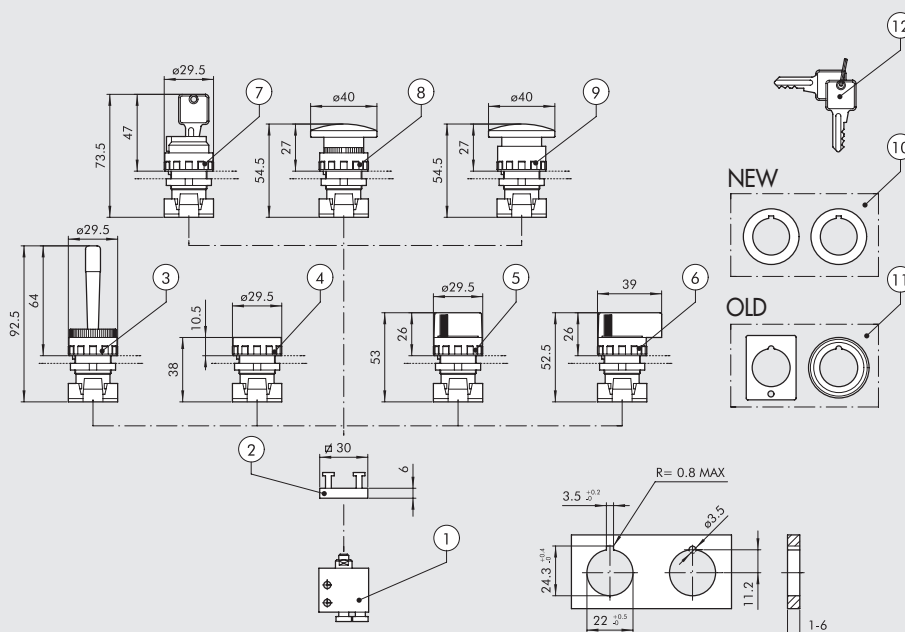

Symbol	Reference	Code	Description	Weight [g]
	①	W3501000100	3/2 NC Axial fittings Ø 4	42
		W3501000111	3/2 NC Axial fittings M5	36
		W3501001101	3/2 NC Side fittings Ø 4	34
		W3501001111	3/2 NC Side fittings M5	34
	①	W3501000101	3/2 NO Axial fittings Ø 4	42
		W3501000110	3/2 NO Axial fittings M5	36
		W3501001100	3/2 NO Side fittings Ø 4	34
		W3501001110	3/2 NO Side fittings M5	34
	②	0351000050	2 places adaptor thickness 6.8 mm	5
	③	W0351000015	Red handler with horizontally pivoted lever	25
	④	W0351000011	Fat push button + 2 red/black coloured disks ◆ Bistable fat push button without disk	15
	⑤	W0351000030	Black selector short lever at 2 positions with return	20
		W0351000031	Black selector short lever at 2 positions	20
	⑤	W0351000032	Black selector short lever at 3 positions with return	20
		W0351000033	Black selector short lever at 3 positions	20
	⑥	W0351000034	Black selector long lever at 2 positions with return	26
		W0351000035	Black selector long lever at 2 positions	26
	⑥	W0351000036	Black selector long lever at 3 positions with return	26
		W0351000037	Black selector long lever at 3 positions	26
	⑦	W0351000016	2 positions key selector with extractable key in 2 positions	50
		W0351000018	2 positions key selector with extractable key in 0	50
	⑧	W0351000013	Red mushroom-head push button Ø 40	27
		W0351000017	Black mushroom-head push button Ø 40	27
	⑨	W0351000014	Red mushroom-head push button with lock Ø 40	29
◆ It can't be supplied. As working replaced by selector with bistable short lever at 2 positions ⑤.	⑩	W0351000049	♣ Reducer from 30 to 22.5 mm	
♣ Usable only with technopolymer body selectors.	⑪	W0351000050	▲ Adapter for bore Ø 30 G2326	
▲ Usable only with metal body selectors.	⑫	W0351000021	♣ Key for ESC selectors	
		W0351000056	Green disk for push button ④	

## VALVES SERIES PEV PEDAL OPERATED



TECHNICAL DATA		Ø 4	M5	1/4"
Valve fitting port	Type	Mono/ bistable guarded	Monostable not guarded	Mono/ bistable guarded
Operating pressure	bar	2.5 to 10	2.5 to 10	-
	Mpa	0.25 to 1	0.25 to 1	
	psi	36 to 145	36 to 145	
Operating temperature range	°C	-10 + 60	-10 + 60	
Nominal diameter	mm	2.5	2.5	7.5
Conductance C	Nl/min · bar	16.5	16.5	264.26
Critical ratio b	bar/bar	0.03	0.03	0.32
Flow rate at 6.3 bar ΔP 0.5 bar	Nl/min	60	60	640
Flow rate at 6.3 bar ΔP 1 bar	Nl/min	95	95	840
Fluid		Filtered air without lubrication; lubrication, if used, must be continuous		

### GUARDED PEDAL WITH VALVES 5/2 1/4" - 3/2 M5 - 3/2 Ø 4

Symbol	Code	Description	Abbrev.
	W312000001	5/2 - 1/4" monostable, guarded	PEV 35 PES PR
	W312000011	5/2 - 1/4" bistable, guarded ●	PEV 35 PEB PR
	W3120000301	3/2 M5 monostable, guarded	PEV 03 PES PR
	W3120000321	3/2 Ø 4 monostable, guarded	PEV F3 PES PR
	W3120000331	3/2 M5 bistable, guarded ●	PEV 03 PEB PR
	W3120000311	3/2 Ø 4 bistable, guarded ●	PEV F3 PEB PR

Symbol	Code	Description	Abbrev.
	W312000021	5/2 - 1/4" monostable, with mechanical block and guarden ■	PEV 35 PEC PR

- The pedal-down position is maintained by a lever. When the foot presses on the lever, the pedal releases and can rise.
- When the foot presses on a locking lever, the pedal can be lowered.

### NOT-GUARDED PEDAL WITH VALVES 3/2 M5 - 3/2 Ø 4

Symbol	Code	Description	Abbrev.
	W3120000411	3/2 - M5 monostable, not guarded	PEV 03 PES WP
	W3120000401	3/2 Ø 4 monostable, not guarded	PEV F3 PES WP

### SYNOPTIC, SIZES AND VERSIONS

PEV FAMILY	F DIMENSIONS	3 FUNCTION	PE OPERATORS 14	C RESETTING (12)	WP FURTHER DETAILS
PEV valve with pedal	3 1/4 0 M5 F Ø 4	3 3/2 5 5/2	PE pedal operated	S mechanical springs C mechanical block B bistable	WP not guarded PR guarded

## TWO HAND SAFETY VALVE SERIES SAFE AIR®

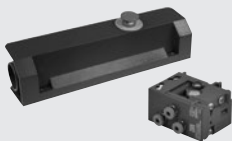

TECHNICAL DATA	
Compressed air couplings	mm
Fluid	Push-in fitting for Ø 4 pipe
Version	Filtered, unlubricated compressed air, max 50 µm
Standard	Single-control - Complete pushbutton panel
	EN574 type IIIA, TÜV approved according to 2006/42/EC
	Certified TÜV-A-MHF/MG 18-00134 (code W360500001)
	Certified Bureau Veritas CV 002-03-2018 (code 0227700000)
Synchronisation, max. time between two signals	s
De-activation time, with pipe L = max 1000 mm	s
Actuation	0.4
Reset	< 0.05
Operating pressure	bar
Temperature range	°C
Nominal diameter	mm
Flow rate at 6 bar (0.6 Mpa - 87 psi) ΔP 1 bar (0.1MPa - 1.45 psi)	Nl/min
Mounting position	In any direction

### TWO HAND SAFETY VALVE

Code	Description
W360500001	Two hand safety valve
<b>Materials</b>	
Body: technopolymer	
Internal parts: brass and technopolymer	
Gaskets: NBR	
Spring: alloy steel	

### PUSHBUTTON HOUSING

Code	Description
W312000021	Pushbutton housing
<b>Materials</b>	
Pressure die-cast and painted aluminium alloy	

### COMPLETE PUSHBUTTON PANEL

Code	Description
0227700000	Complete pushbutton panel
<b>Materials</b>	
Pressure die-cast and painted aluminium alloy	

## SERIES 70 VALVES



### VALVES SERIES 70, HAND OPERATED

TECHNICAL DATA		1/8"	1/4"	1/2"
Operating pressure range:				
• version with direct control	bar		Vacuum to 10	
• pilot-assisted version	bar		2.5 to 10	
Operating temperature range	°C		-10 to +60	
Nominal diameter	mm	5	7.5	15
Conductance C	Nl/min · bar	121.43	264.26	971.43
Critical ratio b	bar/bar	0.32	0.27	0.43
Flow rate at 6 bar ΔP 0.5 bar	Nl/min	400	750	3200
Flow rate at 6 bar ΔP 1 bar	Nl/min	550	1100	4600

#### SYNOPTIC, SIZES AND VERSIONS

M A V FAMILY	2 DIMENSIONS	3 FUNCTION	P P OPERATORS 14	S RESETTING (12)	N C FURTHER DETAILS
MAV manual valves	2 1/8" 3 1/4" 4 1/2"	3 3/2 5 5/2 6 5/3 8 2 x 3/2	PP drawer VL axial lever LE 90° lever BRE arranged for manual panel actuators	A pneumatic/mechanical springs* S mechanical springs B bistable D differential O stable for 5/3	NC normally closed NO normally open OO no indication CC closed centres OC open centres PC pressure centres

\*on demand

#### 90° LEVER 3/2

Symbol	Code	Abbrev.
	7010000100	MAV 23 LES NC 1/8"
	7020000100	MAV 33 LES NC 1/4"
	7030000100	MAV 43 LES NC 1/2"
	7010000200	MAV 23 LEB OO 1/8"
	7020000200	MAV 33 LEB OO 1/4"
	7030000200	MAV 43 LEB OO 1/2"

#### FRONT LEVER 5/3

Symbol	Code	Abbrev.
	7010001150	MAV 28 VLO OC 1/8"
	7010001160	MAV 28 VLS OC 1/8"

#### DRAWER 3/2

Symbol	Code	Abbrev.
	7010001300	MAV 23 PPB OO 1/8"
	7010001200	MAV 23 PPS NC 1/8"

#### 90° LEVER 5/2

Symbol	Code	Abbrev.
	7010000300	MAV 25 LES OO 1/8"
	7020000300	MAV 35 LES OO 1/4"
	7030000300	MAV 45 LES OO 1/2"
	7010000400	MAV 25 LEB OO 1/8"
	7020000400	MAV 35 LEB OO 1/4"
	7030000400	MAV 45 LEB OO 1/2"

#### 90° LEVER 5/3

Symbol	Code	Abbrev.
	7010000500	MAV 26 LEO CC 1/8"
	7020000500	MAV 36 LEO CC 1/4"
	7030000500	MAV 46 LEO CC 1/2"
	7010000600	MAV 26 LEO OC 1/8"
	7020000600	MAV 36 LEO OC 1/4"
	7030000600	MAV 46 LEO OC 1/2"
	7010000700	MAV 26 LEO PC 1/8"
	7020000700	MAV 36 LEO PC 1/4"
	7030000700	MAV 46 LEO PC 1/2"

#### DRAWER 5/2

Symbol	Code	Abbrev.
	7010001600	MAV 25 PPB OO 1/8"
	7010001500	MAV 25 PPS OO 1/8"

#### FRONT LEVER 3/2

Symbol	Code	Abbrev.
	7010001400	MAV 23 VLB OO 1/8"
	7020001400	MAV 33 VLB OO 1/4"

#### PILOT-ASSISTED PLUNGER 3/2 FOR PANEL ACTUATORS

Symbol	Code	Abbrev.
	7010001800	MAV 23 BRE NC 1/8"

#### FRONT LEVER 5/2

Symbol	Code	Abbrev.
	7010001700	MAV 25 VLB OO 1/8"
	7020001700	MAV 35 VLB OO 1/4"

#### PILOT-ASSISTED PLUNGER 5/2 FOR PANEL ACTUATORS

Symbol	Code	Abbrev.
	7010001900	MAV 25 BRE OO 1/8"

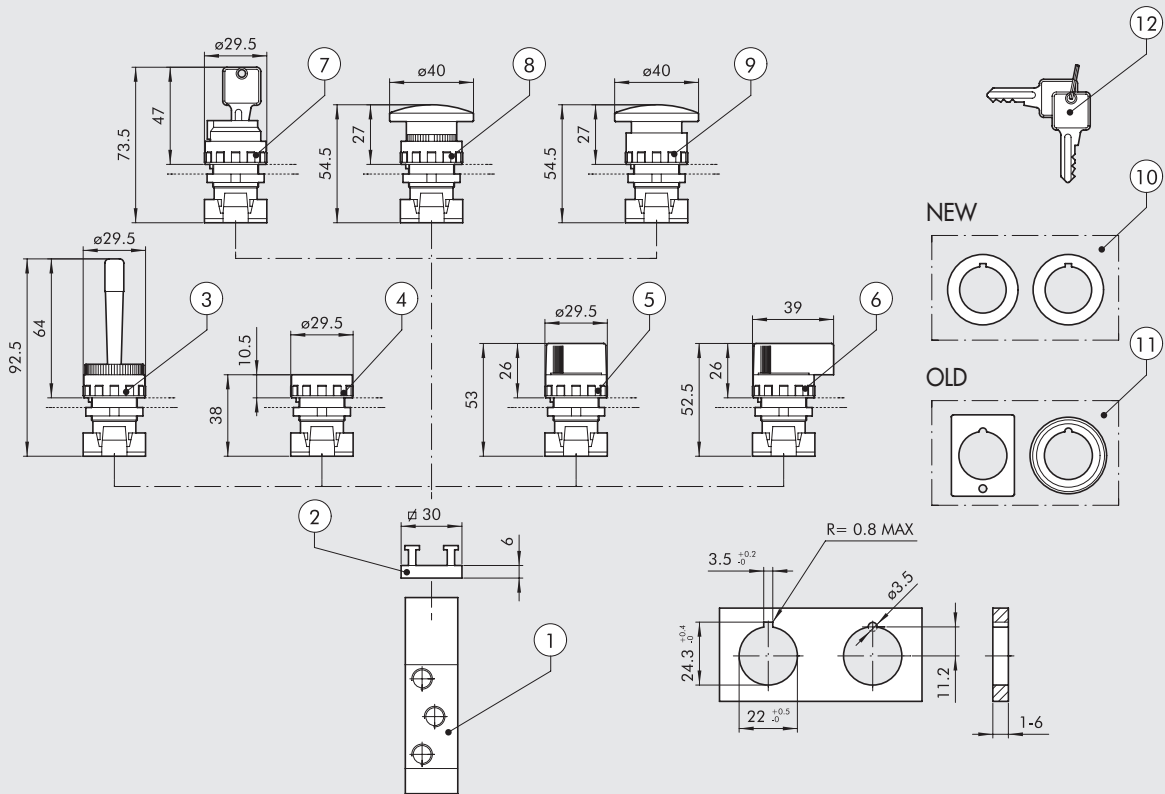
**ASSEMBLY DIAGRAM FOR PILOT-ASSISTED HAND-OPERATED VALVES SERIES 70 WITH PANEL ACTUATORS**

**VALVES**

SERIES 70 VALVES

Symbol	Reference	Code	Description	Weight [g]
	①	7010001800	Pilot-assisted plunger 3/2, 1/8"	124
	①	7010001900	Pilot-assisted plunger 5/2, 1/8"	150
	②	0351000050	2 places adaptor thickness 6.8 mm	5
	③	W0351000015	Red handler with horizontally pivoted lever	25
	④	W0351000011	Fat push button + 2 red/black coloured disks ◆ Bistable fat push button without disk	15
	⑤	W0351000030	Black selector short lever at 2 positions with return	20
	⑤	W0351000031	Black selector short lever at 2 positions	20
	⑤	W0351000032	Black selector short lever at 3 positions with return	20
	⑤	W0351000033	Black selector short lever at 3 positions	20
	⑥	W0351000034	Black selector long lever at 2 positions with return	26
	⑥	W0351000035	Black selector long lever at 2 positions	26
	⑥	W0351000036	Black selector long lever at 3 positions with return	26
	⑥	W0351000037	Black selector long lever at 3 positions	26
	⑦	W0351000016	2 positions key selector with extractable key in 2 positions	50
	⑦	W0351000018	2 positions key selector with extractable key in 0	50
	⑧	W0351000013	Red mushroom-head push button Ø 40	27
	⑧	W0351000017	Black mushroom-head push button Ø 40	27
	⑨	W0351000014	Red mushroom-head push button with lock Ø 40	29
◆ It can't be supplied. As working replaced by selector with bistable short lever at 2 positions ⑤.	⑩	W0351000049	✦ Reducer from 30 to 22.5 mm	
✦ Usable only with technopolymer body selectors.	⑪	W0351000050	▲ Adapter for bore Ø 30 G2326	
▲ Usable only with metal body selectors.	⑫	W0351000021	✦ Key for ESC selectors	
		W0351000056	Green disk for push button ④	

## VALVES SERIES 70, MECHANICALLY OPERATED



TECHNICAL DATA		
Thread at valve ports		1/8"
Operation force at 6 bar:		
• version with direct control	N	50
• pilot-assisted version	N	6
Operating pressure:		
• version with direct control	bar	Vacuum to 10
• pilot-assisted version	bar	2.5 to 10
Operating temperature range	°C	-10 to +60
Nominal diameter	mm	5
Conductance C	Nl/min · bar	121.43
Critical ratio b	bar/bar	0.32
Flow rate at 6 bar ΔP 0.5 bar	Nl/min	400
Flow rate at 6 bar ΔP 1 bar	Nl/min	550

### SYNOPTIC, SIZES AND VERSIONS

M EV FAMILY	2 DIMENSIONS	3 FUNCTION	T A OPERATORS 14	S RESETTING (12)	N C FURTHER DETAILS
MEV mechanically-operated valves	2 1/8"	3 3/2 5 5/2	TA plunger BR bidirectional roller UR unidirectional roller TS sensitive plunger RS sensitive roller AS sensitive aerial LL frontal roller lever	S mechanical springs A pneumatic/mechanical spring* *on demand	NC normally closed OO 5/2

#### PLUNGER 3/2

Symbol	Code	Abbrev.
	7001000100	MEV 23 TAS NC 1/8"

#### UNIDIRECTIONAL ROLLER LEVERS 5/2

Symbol	Code	Abbrev.
	7001000610	MEV 25 URS OO 1/8"

#### PILOT-ASSISTED AERIAL 3/2 NC

Symbol	Code	Abbrev.
	7001000700	MEV 23 ASS NC 1/8"

#### PLUNGER 5/2

Symbol	Code	Abbrev.
	7001000110	MEV 25 TAS OO 1/8"

#### PILOT-ASSISTED PLUNGER 3/2 NC

Symbol	Code	Abbrev.
	7001000200	MEV 23 TSS NC 1/8"

#### PILOT-ASSISTED AERIAL 5/2

Symbol	Code	Abbrev.
	7001000710	MEV 25 ASS OO 1/8"

#### ROLLER LEVER 3/2

Symbol	Code	Abbrev.
	7001000500	MEV 23 BRS NC 1/8"

#### PILOT-ASSISTED PLUNGER 5/2

Symbol	Code	Abbrev.
	7001000210	MEV 25 TSS OO 1/8"

#### ROLLER LEVER 3/2

Symbol	Code	Abbrev.
	7001000900	MEV 23 LLS NC 1/8"

#### ROLLER LEVER 5/2

Symbol	Code	Abbrev.
	7001000510	MEV 25 BRS OO 1/8"

#### PILOT-ASSISTED ROLLER LEVER 3/2 NC

Symbol	Code	Abbrev.
	7001000400	MEV 23 RSS NC 1/8"

#### ROLLER LEVER 5/2

Symbol	Code	Abbrev.
	7001000910	MEV 25 LLS OO 1/8"

#### UNIDIRECTIONAL ROLLER LEVERS 3/2

Symbol	Code	Abbrev.
	7001000600	MEV 23 URS NC 1/8"

#### PILOT-ASSISTED ROLLER LEVER 5/2

Symbol	Code	Abbrev.
	7001000410	MEV 25 RSS OO 1/8"

# VALVES SERIES 70, PNEUMATIC



VALVES

SERIES 70 VALVES

TECHNICAL DATA		1/8"	1/4"	3/8"	1/2"
Operating pressure	bar	Vacuum to 10			
Minimum pilot pressure		2.5			
• monostable	bar	1			
• bistable	bar	-10 to +60			
Operating temperature range	°C	-10 to +60			
Nominal diameter	mm	5	7.5	13.3	15
Conductance C	Nl/min · bar	121.43	264.26	505.52	971.43
Critical ratio b	bar/bar	0.32	0.27	0.32	0.43
Flow rate at 6 bar ΔP 0.5 bar	Nl/min	400	750	1560	3200
Flow rate at 6 bar ΔP 1 bar	Nl/min	550	1100	2150	4600
TRA / TRR monostable at 6 bar	ms	6/15	7/15	5/28	16/46
TRA / TRR bistable at 6 bar	ms	7/7	7/7	13/13	16/16
Manual		-	-	-	monostable on valve body

## SYNOPTIC, SIZES AND VERSIONS

P N V FAMILY	2 DIMENSIONS	3 FUNCTION	P N OPERATORS 14	S RESETTING (12)	N C FURTHER DETAILS
PNV pneumatic valves	2 1/8" 3 1/4" C 3/8" 4 1/2"	3 3/2 5 5/2 6 5/3 ■ 8 2-3/2	PN pneumatic	S mechanical springs B bistable D differential O stable for 5/3 ◆ A pneumatic/mechanical spring	OO 5/2 NC normally closed NO normally open CC closed centres OC open centres PC pressure centres ▲ NC-NO normally closed - normally open

- Only available for size 1/8" and 1/4"
- ◆ On demand
- ▲ Only available for function 2-3/2

### MONOSTABLE 3/2 NO

Symbol	Code	Abbrev.
	7010010400	PNV 23 PNS NO 1/8"
	7020010400	PNV 33 PNS NO 1/4"
	7040010400	PNV C3 PNS NO 3/8"
	7030010400	PNV 43 PNS NO 1/2"

### MONOSTABLE 3/2 NC

Symbol	Code	Abbrev.
	7010010200	PNV 23 PNS NC 1/8"
	7020010200	PNV 33 PNS NC 1/4"
	7040010200	PNV C3 PNS NC 3/8"
	7030010200	PNV 43 PNS NC 1/2"

### MONOSTABLE 5/2

Symbol	Code	Abbrev.
	7010011100	PNV 25 PNS OO 1/8"
	7020011100	PNV 35 PNS OO 1/4"
	7040011100	PNV C5 PNS OO 3/8"
	7030011100	PNV 45 PNS OO 1/2"

### BISTABLE 5/2

Symbol	Code	Abbrev.
	7010011200	PNV 25 PNB OO 1/8"
	7020011200	PNV 35 PNB OO 1/4"
	7040011200	PNV C5 PNB OO 3/8"
	7030011200	PNV 45 PNB OO 1/2"
	7010011300	PNV 25 PND OO 1/8"
	7020011300	PNV 35 PND OO 1/4"
	7040011300	PNV C5 PND OO 3/8"
	7030011300	PNV 45 PND OO 1/2"

### DOUBLE 3/2

Symbol	Code	Abbrev.
	7010013100	PNV 28 PNS NC 1/8"
	7020013100	PNV 38 PNS NC 1/4"
	7010013200	PNV 28 PNS NO 1/8"
	7020013200	PNV 38 PNS NO 1/4"
	7010013300	PNV 28 PNS NC-NO 1/8"
	7020013300	PNV 38 PNS NC-NO 1/4"

### BISTABLE 3/2

Symbol	Code	Abbrev.
	7010010100	PNV 23 PNB OO 1/8"
	7020010100	PNV 33 PNB OO 1/4"
	7040010100	PNV C3 PNB OO 3/8"
	7030010100	PNV 43 PNB OO 1/2"

### MONOSTABLE 5/3

Symbol	Code	Abbrev.
	7010012100	PNV 26 PNS CC 1/8"
	7020012100	PNV 36 PNS CC 1/4"
	7040012100	PNV C6 PNS CC 3/8"
	7030012100	PNV 46 PNS CC 1/2"
	7010012200	PNV 26 PNS OC 1/8"
	7020012200	PNV 36 PNS OC 1/4"
	7040012200	PNV C6 PNS OC 3/8"
	7030012200	PNV 46 PNS OC 1/2"
	7010012300	PNV 26 PNS PC 1/8"
	7020012300	PNV 36 PNS PC 1/4"
	7040012300	PNV C6 PNS PC 3/8"
	7030012300	PNV 46 PNS PC 1/2"



# VALVES SERIES 70, SOLENOID/PNEUMATIC



TECHNICAL DATA	1/8"	1/4"	3/8"	1/2"	
Operating pressure:					
• monostable	bar				
• bistable	bar				
• asserted	bar				
Minimum pilot pressure	bar				
Operating temperature range	°C				
Nominal diameter	mm	5	7.5	13.3	15
Conductance C	Nl/min · bar	121.43	264.26	505.52	971.43
Critical ratio b	bar/bar	0.32	0.27	0.32	0.43
Flow rate at 6 bar ΔP 0.5 bar	Nl/min	400	750	1530	3200
Flow rate at 6 bar ΔP 1 bar	Nl/min	550	1100	2150	4600
TRA / TRR monostable at 6 bar	ms	15/35	19/45	21/72	36/60
TRA / TRR bistable at 6 bar	ms	20/20	21/21	18/18	30/30
Hand operation	bistable				
Coil voltage values	12; 24VDC - 24; 110; 220VAC 50/60Hz				
Power	2 W (DC) 3.5VA (AC)				
Voltage tolerance	%	-10 to +15			
Insulation class		F 155			
Maximum coil nut torque	Nm	1			
Manual		Bistable		Bistable on solenoid pilot Monostable on valve body	

## SYNOPTIC, SIZES AND VERSIONS

SOV FAMILY	2 DIMENSIONS	3 FUNCTION	SO OPERATORS 14	S RESETTING (12)	NC FURTHER DETAILS
SOV solenoid/ pneumatic	2 1/8" 3 1/4" C 3/8" 4 1/2"	3 3/2 5 5/2 6 5/3 ■ 8 2-3/2	SO solenoid SE solenoid assisted	S mechanical springs B bistable D differential P pneumatic ◆ A pneumatic/mechanical spring	NC normally closed NO normally open CC closed centres OC open centres PC pressure centres OO 5/2 ▲ NC-NO normally closed - normally open

■ Only available for size 1/8" and 1/4"  
 ◆ On demand  
 ▲ Only available for function 2-3/2

### MONOSTABLE 3/2 NO

Symbol	Code	Abbrev.
	7010020400	SOV 23 SOS NO 1/8"
	7020020400	SOV 33 SOS NO 1/4"
	7040020400	SOV C3 SOS NO 3/8"
	7030020400	SOV 43 SOS NO 1/2"
	7040020600	SOV C3 SES NO 3/8"

### MONOSTABLE 3/2 NC

Symbol	Code	Abbrev.
	7010020200	SOV 23 SOS NC 1/8"
	7020020200	SOV 33 SOS NC 1/4"
	7040020200	SOV C3 SOS NC 3/8"
	7030020200	SOV 43 SOS NC 1/2"
	7010020500	SOV 23 SES NC 1/8"
	7020020500	SOV 33 SES NC 1/4"
	7040020500	SOV C3 SES NC 3/8"
	7030020500	SOV 43 SES NC 1/2"

### MONOSTABLE 5/2

Symbol	Code	Abbrev.
	7010021100	SOV 25 SOS OO 1/8"
	7020021100	SOV 35 SOS OO 1/4"
	7040021100	SOV C5 SOS OO 3/8"
	7030021100	SOV 45 SOS OO 1/2"
	7010021500	SOV 25 SES OO 1/8"
	7020021500	SOV 35 SES OO 1/4"
	7040021500	SOV C5 SES OO 3/8"
	7030021500	SOV 45 SES OO 1/2"

### BISTABLE 5/2

Symbol	Code	Abbrev.
	7010021200	SOV 25 SOB OO 1/8"
	7020021200	SOV 35 SOB OO 1/4"
	7040021200	SOV C5 SOB OO 3/8"
	7030021200	SOV 45 SOB OO 1/2"
	7010021300	SOV 25 SOD OO 1/8"
	7020021300	SOV 35 SOD OO 1/4"
	7040021300	SOV C5 SOD OO 3/8"
	7030021300	SOV 45 SOD OO 1/2"
	7010021600	SOV 25 SEB OO 1/8"
	7020021600	SOV 35 SEB OO 1/4"
	7040021600	SOV C5 SEB OO 3/8"
	7030021600	SOV 45 SEB OO 1/2"

### BISTABLE 3/2

Symbol	Code	Abbrev.
	7010020100	SOV 23 SOB OO 1/8"
	7020020100	SOV 33 SOB OO 1/4"
	7040020100	SOV C3 SOB OO 3/8"
	7030020100	SOV 43 SOB OO 1/2"
	7010020300	SOV 23 SEB OO 1/8"
	7020020300	SOV 33 SEB OO 1/4"
	7040020300	SOV C3 SEB OO 3/8"
	7030020300	SOV 43 SEB OO 1/2"

### DOUBLE 3/2

Symbol	Code	Abbrev.
	7010023100	SOV 28 SOS NC 1/8"
	7020023100	SOV 38 SOS NC 1/4"
	7010023200	SOV 28 SOS NO 1/8"
	7020023200	SOV 38 SOS NO 1/4"
	7010023300	SOV 28 SOS NC-NO 1/8"
	7020023300	SOV 38 SOS NC-NO 1/4"
	7010023400	SOV 28 SES NC 1/8"
	7020023400	SOV 38 SES NC 1/4"
	7010023500	SOV 28 SES NO 1/8"
	7020023500	SOV 38 SES NO 1/4"
	7010023600	SOV 28 SES NC-NO 1/8"
	7020023600	SOV 38 SES NC-NO 1/4"

### MONOSTABLE 5/3

Symbol	Code	Abbrev.
	7010022100	SOV 26 SOS CC 1/8"
	7020022100	SOV 36 SOS CC 1/4"
	7040022100	SOV C6 SOS CC 3/8"
	7030022100	SOV 46 SOS CC 1/2"
	7010022200	SOV 26 SOS OC 1/8"
	7020022200	SOV 36 SOS OC 1/4"
	7040022200	SOV C6 SOS OC 3/8"
	7030022200	SOV 46 SOS OC 1/2"
	7010022300	SOV 26 SOS PC 1/8"
	7020022300	SOV 36 SOS PC 1/4"
	7040022300	SOV C6 SOS PC 3/8"
	7030022300	SOV 46 SOS PC 1/2"
	7010022400	SOV 26 SES CC 1/8"
	7020022400	SOV 36 SES CC 1/4"
	7040022400	SOV C6 SES CC 3/8"
	7030022400	SOV 46 SES CC 1/2"
	7010022500	SOV 26 SES OC 1/8"
	7020022500	SOV 36 SES OC 1/4"
	7040022500	SOV C6 SES OC 3/8"
	7030022500	SOV 46 SES OC 1/2"
	7010022600	SOV 26 SES PC 1/8"
	7020022600	SOV 36 SES PC 1/4"
	7040022600	SOV C6 SES PC 3/8"
	7030022600	SOV 46 SES PC 1/2"

## ACCESSORIES FOR SERIES 70 VALVES

### MANIFOLD FOR PNV-SOV VALVES



Code	Description
0221000190	Kit high bracket + fit valv. 1/8
0221000191	Kit low bracket + fit valv. 1/8
0221000192	Kit extra low bracket + fit valv. 1/8
0221000200	Kit manifold 2-position CSA-18-02
0221000300	Kit manifold 3-position CSA-18-03
0221000400	Kit manifold 4-position CSA-18-04
0221000500	Kit manifold 5-position CSA-18-05
0221000600	Kit manifold 6-position CSA-18-06
0221000700	Kit manifold 6-position CSA-18-07
0222000190	Kit high bracket + fit valv. 1/4
0222000191	Kit low bracket + fit valv. 1/4
0222000192	Kit extra low bracket + fit valv. 1/4
0222000200	Kit manifold 2-position CSA-14-02
0222000300	Kit manifold 3-position CSA-14-03
0222000400	Kit manifold 4-position CSA-14-04
0222000500	Kit manifold 5-position CSA-14-05
0222000600	Kit manifold 6-position CSA-14-06
0222000700	Kit manifold 7-position CSA-14-07

### MODULAR BASES FOR SOV-PNV VALVES



Code	Description
0226004000	Acc. intermediate diaphragm 1/8
0226004001	Complete plug 3/2 1/8
0226004150	Acc. modular manifold base 1/8
0226004200	Acc. end plate with OR 1/8
0226004201	Acc. end plate without OR 1/8
0226004300	Acc. intermediate part for upper feed 1/8
0226004500	Acc. blanking plate 1/8
0226004600	Acc. adapter for omega bar 1/8
0226005000	Acc. intermediate diaphragm 1/4
0226005001	Complete plug 3/2 1/4
0226005150	Acc. modular manifold base 1/4
0226005200	Acc. end plate with OR 1/4
0226005201	Acc. end plate without OR 1/4
0226005300	Acc. intermediate part for upper feed 1/4
0226005500	Acc. blanking plate 1/4
0226005600	Acc. adapter for omega bar 1/4
0226006600	Dimensional adapter 1/8-1/4

### MULTIPLE BASES FOR SOV-PNV VALVES

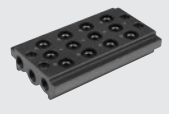

Code	Description
0223000201	2-position base CVM-18-02
0223000301	3-position base CVM-18-03
0223000401	4-position base CVM-18-04
0223000501	5-position base CVM-18-05
0223000601	6-position base CVM-18-06
0223000701	7-position base CVM-18-07
0223000801	8-position base CVM-18-08
0223000901	9-position base CVM-18-09
0223001001	10-position base CVM-18-10
0224000201	2-position base CVM-14-02
0224000301	3-position base CVM-14-03
0224000401	4-position base CVM-14-04
0224000501	5-position base CVM-14-05
0224000601	6-position base CVM-14-06
0224000701	7-position base CVM-14-07
0224000801	8-position base CVM-14-08
0224000901	9-position base CVM-14-09
0224001001	10-position base CVM-14-10

### GASKET KIT



Code	Description
0226004701	Kit gasket for 1/8" base
0226005701	Kit gasket for 1/4" base

## VALVES SERIES 70, ON BASE

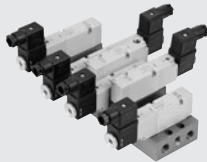

### SYNOPTIC, SIZES AND VERSIONS

P N V FAMILY		B DIMENSIONS	5 FUNCTION	P N OPERATORS 14	S RESETTING (12)	O O FURTHER DETAILS
PNV	pneumatic	B 1/8" on base	5 5/2	PN pneumatic	S mechanical springs	OO 5/2
SOV	electro-pneumatic		6 5/3	SO solenoid	B bistable	CC closed centres
				SE solenoid assisted	D differential	OC open centres
						PC pressure centres

### MULTI-PURPOSE BASE FOR VALVES SERIES 70 ON BASE

Reference	Code	Description
①	0223100201	2-position base 1/8 on base
	0223100401	4-position base 1/8 on base
	0223100601	6-position base 1/8 on base
	0223100801	8-position base 1/8 on base
	0223101001	10-position base 1/8 on base
②	0223106301	Separate feed kit
③	0223106303	Exhaust regulation kit
④	0223106302	Exhaust feed kit
⑤	0223106500	Blanking plate
⑥	0226004600	Adapter for omega bar

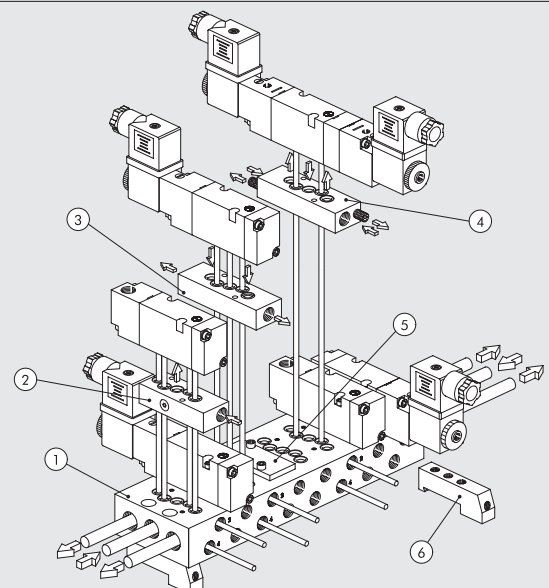

## VALVES, SERIES 70, PNEUMATIC, ON BASE



TECHNICAL DATA		
Operating pressure	bar	Vacuum to 10
Minimum actuation pressure:		
• monostable	bar	2.5
• bistable	bar	1
Operating temperature range	°C	-10 to +60
Nominal diameter	mm	5
Conductance C	NI/min · bar	107.69
Critical ratio b	bar/bar	0.29
Flow rate at 6 bar ΔP 0.5 bar	NI/min	320
Flow rate at 6 bar ΔP 1 bar	NI/min	450
TRA / TRR monostable at 6 bar	ms	6/15
TRA / TRR bistable at 6 bar	ms	7/7

### MONOSTABLE 5/2

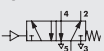
Symbol	Code	Abbrev.
	7011011100	PNV B5 PNS OO

### BISTABLE 5/2

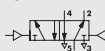
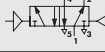
Symbol	Code	Abbrev.
	7011011200	PNV B5 PNB OO
	7011011300	PNV B5 PND OO

### MONOSTABLE 5/3

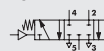
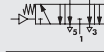
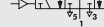
Symbol	Code	Abbrev.
	7011012100	PNV B6 PNS CC
	7011012200	PNV B6 PNS OC
	7011012300	PNV B6 PNS PC

## VALVES SERIES 70, SOLENOID/PNEUMATIC, ON BASE



TECHNICAL DATA		
Operating pressure:		
• monostable	bar	2.5 to 10
• bistable	bar	1 to 10
• pilot-assisted	bar	Vacuum to 10
Minimum pilot pressure	bar	2.5
Operating temperature range	°C	-10 to +60
Nominal diameter	mm	5
Conductance C	NI/min · bar	107.69
Critical ratio b	bar/bar	0.29
Flow rate at 6 bar ΔP 0.5 bar	NI/min	320
Flow rate at 6 bar ΔP 1 bar	NI/min	450
TRA / TRR monostable at 6 bar	ms	15 / 35
TRA / TRR bistable at 6 bar	ms	20 / 20
<b>Electrical technical data</b>		
Coil voltage values		12VDC to 24VDC to 24VAC to 110VAC to 220VAC 50/60Hz
Power		2 W (DC) 3.5VA (AC)
Voltage tolerance	%	-10 to +15
Insulation class		F 155
Maximum coil nut torque	Nm	1

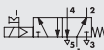
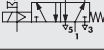

### MONOSTABLE 5/2

Symbol	Code	Abbrev.
	7011021100	SOV B5 SOS OO
	7011021500	SOV B5 SES OO

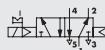
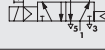
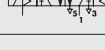
### BISTABLE 5/2

Symbol	Code	Abbrev.
	7011021200	SOV B5 SOB OO
	7011021300	SOV B5 SOD OO
	7011021600	SOV B5 SEB OO

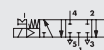
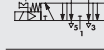
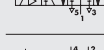
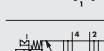
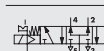
### MONOSTABLE 5/3

Symbol	Code	Abbrev.
	7011022100	SOV B6 SOS CC
	7011022200	SOV B6 SOS OC
	7011022300	SOV B6 SOS PC
	7011022400	SOV B6 SES CC
	7011022500	SOV B6 SES OC
	7011022600	SOV B6 SES PC

## NAMUR VALVES



### TECHNICAL DATA

Operating pressure:		
• monostable, electric	bar	2.5 to 10
• bistable, electric	bar	1 to 10
• pilot-assisted, electric	bar	Vacuum to 10
Minimum actuation pressure:		
• monostable, pneumatic	bar	2.5
• bistable, pneumatic	bar	1
Operating temperature range	°C	-10 to +60
Nominal diameter	mm	7.5
Conductance C	Nl/min · bar	264.26
Critical ratio b	bar/bar	0.27
Flow rate at 6 bar ΔP 0.5 bar	Nl/min	750
Flow rate at 6 bar ΔP 1 bar (0.1 Mpa - 14.5 psi)	Nl/min	1100
Response time at 6 bar:		
• TRA/TRR monostable, pneumatic at 6 bar	ms	7 / 15
• TRA/TRR bistable, pneumatic at 6 bar	ms	7 / 7
• TRA/TRR monostable electric at 6 bar	ms	19 / 45
• TRA/TRR bistable electric at 6 bar	ms	21 / 21

### SYNOPTIC, SIZES AND VERSIONS

P N V FAMILY		A DIMENSIONS		5 FUNCTION		P N OPERATORS 14		S RESETTING (12)		O O FURTHER DETAILS	
PNV	pneumatic	A	NAMUR	5	5/2	PN	pneumatic	S	mechanical springs	OO	5/2
SOV	electro-pneumatic			4	4/2	SO	solenoid	B	bistable	NC	normally closed

#### MONOSTABLE, PNEUMATIC 4/2

Symbol	Code	Abbrev.
	7021010110	PNV A4 PNS NC

#### BISTABLE, SOLENOID/PNEUMATIC 4/2

Symbol	Code	Abbrev.
	7021020210	SOV A4 SOB OO

#### MONOSTABLE, SOLENOID/PNEUMATIC 5/2

Symbol	Code	Abbrev.
	7021020100	SOV A5 SOS OO

#### BISTABLE, PNEUMATIC 4/2

Symbol	Code	Abbrev.
	7021010210	PNV A4 PNB OO

#### MONOSTABLE, PNEUMATIC 5/2

Symbol	Code	Abbrev.
	7021010100	PNV A5 PNS OO

#### BISTABLE, SOLENOID/PNEUMATIC 5/2

Symbol	Code	Abbrev.
	7021020200	SOV A5 SOB OO

#### MONOSTABLE, SOLENOID/PNEUMATIC 4/2

Symbol	Code	Abbrev.
	7021020110	SOV A4 SOS NC

#### BISTABLE, PNEUMATIC 5/2

Symbol	Code	Abbrev.
	7021010200	PNV A5 PNB OO

## VALVES SERIES BASIC

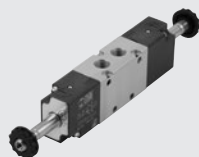

TECHNICAL DATA	1/8"	1/4"
Operating pressure:		
• monostable	bar	2.5 to 10
• bistable	bar	1 to 10
Operating temperature range	°C	-10 to +60
Nominal diameter	mm	5
Conductance C	NI/min · bar	121.43
Critical ratio b	bar/bar	0.32
Flow rate at 6 bar ΔP 0.5 bar	NI/min	400
Flow rate at 6 bar ΔP 1 bar	NI/min	550
TRA / TRR monostable at 6 bar	ms	15/35
TRA / TRR bistable at 6 bar	ms	20/20
Coil voltage values		12; 24 VDC - 24; 110; 220V AC 50/60Hz
Power		2 W (DC) 3.5VA (AC)
Voltage tolerance	%	-10 to +15
Insulation class		F 155
Maximum coil nut torque	Nm	1
Hand operation		Bistable
Installation		In any position (vertical assembly is not recommended for bistable valves subjected to vibration)
Fluid		Filtered air without lubrication; lubrication, if used, must be continuous
Recommended lubricant		ISO and UNI FD 22
Maximum coil nut torque	Nm	1

### MONOSTABLE 3/2 NO

Symbol	Code	Abbrev.
	7090020200	ELPN 1/8 3/2 MON NC 1/8"
	7091020200	ELPN 1/4 3/2 MON NC 1/4"

### MONOSTABLE 3/2 NC

Symbol	Code	Abbrev.
	7090021100	ELPN 1/8 5/2 MON 1/8"
	7091021100	ELPN 1/4 5/2 MON 1/4"

### BISTABLE 5/2

Symbol	Code	Abbrev.
	7090021200	ELPN 1/8 5/2 BIS 1/8"
	7091021200	ELPN 1/4 5/2 BIS 1/4"

## ACCESSORIES

### MANIFOLDS



See pag. 89

### BASES



See pag. 89

### MULTIPLE BASE



Code	Description
0223200201	2 positions multiple base BASIC 1/8
0223200301	3 positions multiple base BASIC 1/8
0223200401	4 positions multiple base BASIC 1/8
0223200501	5 positions multiple base BASIC 1/8
0223200601	6 positions multiple base BASIC 1/8
0223200701	7 positions multiple base BASIC 1/8
0223200801	8 positions multiple base BASIC 1/8
0223200901	9 positions multiple base BASIC 1/8
0223201001	10 positions multiple base BASIC 1/8
0224200201	2 positions multiple base BASIC 1/4
0224200301	3 positions multiple base BASIC 1/4
0224200401	4 positions multiple base BASIC 1/4
0224200501	5 positions multiple base BASIC 1/4
0224200601	6 positions multiple base BASIC 1/4
0224200701	7 positions multiple base BASIC 1/4
0224200801	8 positions multiple base BASIC 1/4
0224200901	9 positions multiple base BASIC 1/4
0224201001	10 positions multiple base BASIC 1/4

## 10-mm SOLENOID VALVES SERIES PLT-10



TECHNICAL DATA	
Type	3/2 NC
Operating temperature range (Te) °C	5 to 50
Fluid temperature (Tg) °C	5 to 50
Fluid	Filtered, lubricated or unlubricated air
Operating life	Over 50 million cycles
Weight g	12
Voltage tolerance ΔV	± 10 %
Max operating frequency f	30 Hz
Switching factor ED	100 %
Insulation class	F155
Index of protection	IP51 for PLUG-IN version IP65 for M8 version

### KEY TO CODES

7 2 2	1	1	3	3	4	0	1	00
FAMILY	POSITIONING	POWER CONNECTION	Ø THROUGH	POWER	VOLTAGE	LED	MANUAL CONTROL	VERSION
Solenoid valves series "PLT-10"	1 Base and connection on same side	1 Plug-in	3 0.6 mm 6 1.2 mm	3 0.7 W 5 0.8 W 8 3/0.3 W 9 4.2/0.7 W	3 12 VDC 4 24 VDC 4 24 VDC	0 - 1 LED 1 LED	0 - 1 Manual monostable	00 Standard
	2 Base and connection opposite sides							
	2 Base and connection opposite sides	M M8x1		5 0.8 W 9 4.2/0.7 W				

### PLT-10 WITH BASE AND CONNECTION ON THE SAME SIDE

Version (3/2 NC)	Code	Manual	Voltage [Volt]	Power [Watt]	Through Ø [mm]	Operating press. [bar]	Flow rate at 6 ΔP=1 bar [NI/min]	Tmax coil a 24VDC Te 20°C a ED100% [°C]	Weight [g]
Without LED	722113330000	without	12 VDC	0.7	0.6	3 to 7	9	93	12
	722113330100	with	12 VDC	0.7	0.6	3 to 7	9	93	12
	722113340000	without	24 VDC	0.7	0.6	3 to 7	9	93	12
	722113340100	with	24 VDC	0.7	0.6	3 to 7	9	93	12
With LED	722113531000	without	12 VDC	0.8	0.6	3 to 7	9	93	12
	722113531100	with	12 VDC	0.8	0.6	3 to 7	9	93	12
	722113541000	without	24 VDC	0.8	0.6	3 to 7	9	93	12
	722113541100	with	24 VDC	0.8	0.6	3 to 7	9	93	12
SPEED-UP and LED	722116841000	without	24 VDC	3/0.3	1.2	2 to 7	16	51	12
	722116841100	with	24 VDC	3/0.3	1.2	2 to 7	16	51	12
	722116941000	without	24 VDC	4.2/0.7	1.2	2 to 7	30	51	12
	722116941100	with	24 VDC	4.2/0.7	1.2	2 to 7	30	51	12

### PLT-10 WITH BASE AND CONNECTION ON OPPOSITE SIDES

Version (3/2 NC)	Code	Manual	Voltage [Volt]	Power [Watt]	Through Ø [mm]	Operating press. [bar]	Flow rate at 6 ΔP=1 bar [NI/min]	Tmax coil a 24VDC Te 20°C a ED100% [°C]	Weight [g]
Without LED	722213330000	without	12 VDC	0.7	0.6	3 to 7	9	93	12
	722213330100	with	12 VDC	0.7	0.6	3 to 7	9	93	12
	722213340000	without	24 VDC	0.7	0.6	3 to 7	9	93	12
	722213340100	with	24 VDC	0.7	0.6	3 to 7	9	93	12
With LED	722213531000	without	12 VDC	0.8	0.6	3 to 7	9	93	12
	722213531100	with	12 VDC	0.8	0.6	3 to 7	9	93	12
	722213541000	without	24 VDC	0.8	0.6	3 to 7	9	93	12
	722213541100	with	24 VDC	0.8	0.6	3 to 7	9	93	12
SPEED-UP and LED	722216841000	without	24 VDC	3/0.3	1.2	2 to 7	16	51	12
	722216841100	with	24 VDC	3/0.3	1.2	2 to 7	16	51	12
	722216941000	without	24 VDC	4.2/0.7	1.2	2 to 7	30	51	12
	722216941100	with	24 VDC	4.2/0.7	1.2	2 to 7	30	51	12

### PLT-10 WITH BASE AND M8 CONNECTION ON OPPOSITE SIDES

Version 3/2 NC	Code	Manual	Voltage [Volt]	Power [Watt]	Through Ø [mm]	Operating press. [bar]	Flow rate at 6 bar ΔP=1 bar [NI/min]	Tmax coil a 24VDC Te 20°C a ED100% [°C]	Weight [g]
With LED	7222M3541000	without	24 VDC	0.8	0.6	3 to 7	9	93	12
	7222M3541100	with	24 VDC	0.8	0.6	3 to 7	9	93	12
SPEED-UP and LED	7222M6941000	without	24 VDC	4.2/0.7	1.2	2 to 7	30	51	12
	7222M6941100	with	24 VDC	4.2/0.7	1.2	2 to 7	30	51	12



### BASES FOR PLT-10

Code	Description	Code	Description	N.B.: For multiple manifold bases with PLT-10 M8 connection, only use straight connectors code 02400A_____
W0400100101	Base 1 posn. for PLT-10	W0400100107	Base 7 posn. for PLT-10	
W0400100102	Base 2 posn. for PLT-10	W0400100108	Base 8 posn. for PLT-10	
W0400100103	Base 3 posn. for PLT-10	W0400100109	Base 9 posn. for PLT-10	
W0400100104	Base 4 posn. for PLT-10	W0400100110	Base 10 posn. for PLT-10	
W0400100105	Base 5 posn. for PLT-10			
W0400100106	Base 6 posn. for PLT-10			

## BASES FOR PLT-10 MULTIPLE CONNECTION

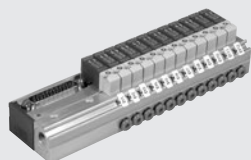

TECHNICAL DATA		
Supply voltage		12 VDC or 24 VDC
Max input	W	0.7 for position for PLT-10 STD without LED 0.8 for position for PLT-10 STD with LED 3/0.3 for position for PLT-10 NC with Speed-up 3/0.7 for position for PLT-10 NO with Speed-up 4.2/0.7 for position for PLT-10 NC with Speed-up high flow
Valve actuation indicator		Led mounted on the PLT-10 (on versions of solenoid valve where envisaged)
Operating temperature range	°C	5 to 50
Protection degree (with valves and connectors mounted)		IP 40
Maximum number of mountable PLT-10s		24
Number of contacts		9, of which 1 common, for versions with 4 and 8 positions 25, of which 1 common, for versions with 4, 8, 12, 16, 20, 24 positions

### CONNECTION DIAGRAM

25 PIN						9 PIN			
Position of electrical contact	N° PLT	Position of electrical contact	N° PLT	Position of electrical contact	N° PLT	Position of electrical contact	N° PLT	Position of electrical contact	N° PLT
1	PLT1	8	PLT8	15	PLT15	22	PLT22	1	PLT1
2	PLT2	9	PLT9	16	PLT16	23	PLT23	2	PLT2
3	PLT3	10	PLT10	17	PLT17	24	PLT24	3	PLT3
4	PLT4	11	PLT11	18	PLT18	25	COMMON (-)	4	PLT4
5	PLT5	12	PLT12	19	PLT19			5	PLT5
6	PLT6	13	PLT13	20	PLT20			6	PLT6
7	PLT7	14	PLT14	21	PLT21			7	PLT7
								8	PLT8
								9	COMMON (-)

### CODES FOR BASES 9 AND 25 PINS

Code	Description	Weight [g]
0210040004	4-posn. base PLT 10 9-PIN mult conn.	160
0210040008	8-posn. base PLT 10 9-PIN mult conn.	235
0210240004	4-posn. base PLT 10 25-PIN mult conn.	210
0210240008	8-posn. base PLT 10 25-PIN mult conn.	280
0210240012	12-posn. base PLT 10 25-PIN mult conn.	355
0210240016	16-posn. base PLT 10 25-PIN mult conn.	430
0210240020	20-posn. base PLT 10 25-PIN mult conn.	500
0210240024	24-posn. base PLT 10 25-PIN mult conn.	575

## PLT-10 FOR MULTIPLE ELECTRIC CONNECTION

TECHNICAL DATA		NC	NO
Type		3/2 NC et NO	
Operating temperature range (Te)	°C	5 to 50	
Fluid temperature (Tg)	°C	5 to 50	
Fluid		Filtered, lubricated or unlubricated air	
Operating life		Over 50 million cycles	
Weight	g	12	
Voltage tolerance	ΔV	± 10 %	
Max operating frequency	f	30 Hz	
Switching factor	ED	100 %	
Insulation class		F155	
Degree of protection		IP 51	IP 50

### KEY TO CODES

7 2 2	1	1	3	3	4	0	1	0	0
FAMILY	POSITIONING	POWER CONNECTION	Ø THROUGH	POWER	VOLTAGE	LED	MANUAL CONTROL	VERSION	
Solenoid valves series "PLT-10"	1 Base and connection on same side	1 For multiple base	3 0.6 mm 6 1.2 mm	3 0.7 W 5 0.9 W 8 3/0.3 W for NC 3/0.7 W for NO 9 4.2/0.7 W	3 12 VDC 4 24 VDC	0 - 1 LED	0 - 1 manual monostable	0 NC 1 NO	0 Standard

**PLT-10 NC-NO FOR MULTIPLE ELECTRIC CONNECTION**

Version (3/2 NC)	Code	Manual	Voltage [Volt]	Power [Watt]	Ø Through [mm]	Operating pressure [bar]	Flow rate at 6 ΔP=1 bar [Nl/min]	T Max coil T at 24VDC Te 20°C α ED100% [°C]	Weight [g]
Without LED	722123330000	without	12 VDC	0.7	0.6	3 to 7	9	93	12
	722123330100	with	12 VDC	0.7	0.6	3 to 7	9	93	12
	722123340000	without	24 VDC	0.7	0.6	3 to 7	9	93	12
	722123340100	with	24 VDC	0.7	0.6	3 to 7	9	93	12
With LED	722123531000	without	12 VDC	0.8	0.6	3 to 7	9	93	12
	722123531100	with	12 VDC	0.8	0.6	3 to 7	9	93	12
	722123541000	without	24 VDC	0.8	0.6	3 to 7	9	93	12
	722123541100	with	24 VDC	0.8	0.6	3 to 7	9	93	12
SPEED-UP and LED	722126841000	without	24 VDC	3/0.3	1.2	2 to 7	16	51	12
	722126841100	with	24 VDC	3/0.3	1.2	2 to 7	16	51	12
	722126941000	without	24 VDC	4.2/0.7	1.2	2 to 7	30	51	12
	722126941100	with	24 VDC	4.2/0.7	1.2	2 to 7	30	51	12
Version (3/2 NO)	Code	Manual	Voltage [Volt]	Power [Watt]	Ø Through [mm]	Operating pressure [bar]	Flow rate at 6 ΔP=1 bar [Nl/min]	T Max coil T at 24VDC Te 20°C α ED100% [°C]	Weight [g]
SPEED-UP and LED	722126841010	without	24 VDC	3/0.7	1.0	2 to 7	14	51	12
	722126841110	with	24 VDC	3/0.7	1.0	2 to 7	14	51	12

**ACCESSORIES**
**CAP FOR UNUSED POSITION**

Code	Description	Weight [g]
W0400100200	Cap 10 mm	6

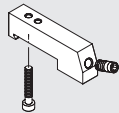
**CONNECTION BRACKETS ON BAR OMEGA (DIN EN 50022)**

Code	Description	Weight [g]
0227301610	Connection brackets on DIN BAR PLT-10	30

Supplied complete with one M3x20 screws and one M6 grub screw. Individually packed

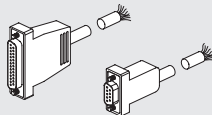
**STRAIGHT PRE-WIRED CONNECTOR KIT**

Code	Description	Weight [g]
0226900100	Straight D-Sub 9-PIN connector + cable L = 1 m	80
0226900250	Straight D-Sub 9-PIN connector + cable L = 2.5 m	170
0226900500	Straight D-Sub 9-PIN connector + cable L = 5 m	320
0226900750	Straight D-Sub 9-PIN connector + cable L = 7.5 m	470
0226901000	Straight D-Sub 9-PIN connector + cable L = 10 m	620
0226901500	Straight D-Sub 9-PIN connector + cable L = 15 m	920
0226902000	Straight D-Sub 9-PIN connector + cable L = 20 m	1220
0226905000	Straight D-Sub 9-PIN connector + cable L = 50 m	3020
0226920100	Straight D-Sub 25-PIN connector + cable L = 1 m	132
0226920250	Straight D-Sub 25-PIN connector + cable L = 2.5 m	320
0226920500	Straight D-Sub 25-PIN connector + cable L = 5 m	636

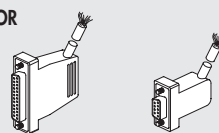
**PRE-WIRED 90° CONNECTOR**

Code	Description	Weight [g]
0226910100	90° D-Sub 9-PIN connector + cable L = 1 m	80
0226910250	90° D-Sub 9-PIN connector + cable L = 2.5 m	170
0226910500	90° D-Sub 9-PIN connector + cable L = 5 m	320
0226910750	90° D-Sub 9-PIN connector + cable L = 7.5 m	470
0226911000	90° D-Sub 9-PIN connector + cable L = 10 m	620
0226911500	90° D-Sub 9-PIN connector + cable L = 15 m	920
0226930100	90° D-Sub 25-PIN connector + cable L = 1 m	132
0226930250	90° D-Sub 25-PIN connector + cable L = 2.5 m	320
0226930500	90° D-Sub 25-PIN connector + cable L = 5 m	636

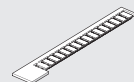
**IDENTIFICATION PLATE KIT**

Code	Description	Weight [g]
0226107000	Identification plate kit	30

Comes in 16-pc. packs

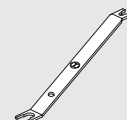
**R17 - PIPE RELEASE SPANNER**

Code	Description	Ø Pipe
2L17001	RL17	from Ø 3 to Ø 10

Note: For racc. R et racc. Fox

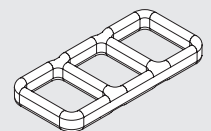
**SPARE PARTS**
**INTERFACE GASKET**

Code	Description
0226009701	PLT-10 gasket

N.B. 50 for pack

**STANDARD SECURING SCREW (FOR ALUMINIUM)**

Code	Description
0226009702	PLT-10 screw for aluminium

N.B. 100 for pack

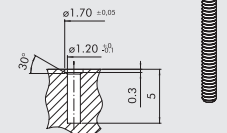
**SECURING SCREWS FOR TECHNOPOLYMER**

Code	Description
0226009703	Screw PLT-10 for technopol.

N.B. 100 for pack

When mounting on technopolymer bodies, use these screws instead of the ones supplied with the PLT-10. **ATTENTION: approximative dimensions for not added glass plastic materials It's always advisable to effect assembling tests.**

## SOLENOID VALVES PIV.M 15 mm

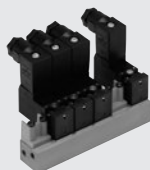



TECHNICAL DATA		
Voltage tolerance	%	-10 to +15
Frequenza tensione alternativa (AC)	Hz	50/60
Max operating frequency	Hz	30
Solenoid rating		100% ED
Response time	ms	~ 10
Type of protection		IP 65 EN 60529
Power connection		9.4 mm micro centre distance
Insulation class		155
Ambient temperature	°C	-10 to + 50
Fluid temperature	°C	-10 to + 50
Fluid		Filtered lubricated or unlubricated air
Operating life		100 million cycles
Materials		Body: PPS Spring: 302 stainless steel FKM/FPM gaskets
Weight	g	30
Manual control		Monostable
Assembly position		In any position

### SYNOPTIC, SIZES AND VERSIONS

P I V FAMILY	1 AIR HOLE	3 NUMBER OF WAYS	M DIMENSIONS	0 THREAD	1 VERSION	N C FURTHER DETAILS
	1 1 mm	3 3 ways	M 15 x 15	0 on base	1 24 VDC	NC normally closed
	3 1.1 mm				3 24 VAC	NO normally open
	6 1.5 mm				5 110 VAC	
					7 220 VAC	

### PIV.M STD

Symbol	Code	Description	Voltage [Volt]	Flow rate [Watt]	Air hole Ø [mm]	kv Factor	Operating [bar]
	W4015001000	PIV33M01 NC	24VDC	2.5W	1.1	0.42	0 to 10
	W4015001010	PIV33M03 NC	24VAC	2W - 3VA	1.1	0.42	0 to 10
	W4015001020	PIV33M05 NC	110VAC	2W - 3VA	1.1	0.42	0 to 10
	W4015001030	PIV33M07 NC	220VAC	2W - 3VA	1.1	0.42	0 to 10
	W4015001100	PIV63M01 NC	24VDC	2.5W	1.5	0.55	0 to 6
	W4015001110	PIV63M03 NC	24VAC	2W - 3VA	1.5	0.55	0 to 6
	W4015001120	PIV63M05 NC	110VAC	2W - 3VA	1.5	0.55	0 to 6
	W4015002000	PIV13M01 NO	24VDC	2.5W	1	0.33	0 to 6
	W4015002010	PIV13M03 NO	24VAC	2W - 3VA	1	0.33	0 to 6
	W4015002020	PIV13M05 NO	110VAC	2W - 3VA	1	0.33	0 to 6
	W4015002030	PIV13M07 NO	220VAC	2W - 3VA	1	0.33	0 to 6

### MULTIPLE BASE FOR PIV.M

Code	Description	Abbrev.	Weight [g]
W0400101001	Single base 1 position	B5001	6
W0400101002	Multiple base 2 positions	B5002	24
W0400101003	Multiple base 3 positions	B5003	34
W0400101004	Multiple base 4 positions	B5004	46
W0400101005	Multiple base 5 positions	B5005	58
W0400101006	Multiple base 6 positions	B5006	70
W0400101007	Multiple base 7 positions	B5007	82
W0400101008	Multiple base 8 positions	B5008	98
W0400101009	Multiple base 9 positions	B5009	106
W0400101010	Multiple base 10 positions	B5010	114

### MICRO ELECTRIC CONNECTOR 15 mm

Code	Colour	Type
W0970500011	Black	Standard
W0970500012	Transparent	LED 24V
W0970500013	Transparent	LED 110V
W0970500015	Transparent	LED + VDR 24V
W0970500016	Transparent	LED + VDR 110V

### END PLUG - UNUSED POSITION

Code	Description	Weight [g]
W0400102000	End plug	6

### END PLUG - PORT 1

Code	Description	Weight [g]
W0400102002	End plug - port 1	4

## PIV VALVES ON BASE





TECHNICAL DATA	PIV.I ON BASE	PIV.T ON BASE	PIV.B ON BASE
Absorption	5W - 5VA	3.8W - 6.5VA	10W - 13VA
Voltage available	12-24 VDC / 24-110-220 VAC	24VDC / 24-110-220 VAC	24VDC / 24-110-220 VAC
Voltage tolerance	% -10 to +15	% -10 to +15	% -10 to +15
Max operating frequency	Hz 30	Hz 30	Hz 15
Solenoid rating	% 100	% 100	% 100
Response time	ms 8 to 15	ms 8 to 15	ms 10 to 15
Type of protection	IP 65	IP 65	IP 65
Type of coil	Coil side 22 Ø 8 DIN 43650	Coil side 22 Ø 9 DIN 43650	Coil side 30 DIN 43650
Insulation class	155	155	155
Ambient temperature	°C -15 to 50	°C -15 to 50	°C -15 to 50
Fluid temperature	°C -15 to 50	°C -15 to 50	°C -15 to 50
Fluid	Filtered lubricated or unlubricated air 25 million cycles	Filtered lubricated or unlubricated air 25 million cycles	Filtered lubricated or unlubricated air
Working life			-
Weight	g 80 to 120 (according to the version)	g 85	g 250
Maximum coil nut torque	Nm 1	Nm 1	Nm 1



### SYNOPTIC, SIZES AND VERSIONS

PIV FAMILY	5 AIR HOLE	3 NUMBER OF WAYS	T CONNECTION	0 THREAD	O VERSION	N C FURTHER DETAILS
	4 1.2 mm 7 1.6 mm 8 1.8 mm Y 2.4 mm	2 2 ways 3 3 ways	I 22x22 operator Ø 8 T 22x22 operator Ø 9 B 30x30 operator Ø 13	0 on base	O on base with conveyed exhaust B on base S standard	NC normally closed NO normally open



#### PIV.I VALVES, OPERATOR Ø 8, ON BASE

Symbol	Code	Description	Air hole Ø [mm]	kv Factor	Max oper. pressure [bar]	
					DC	AC
	W4018000200	PIV42IOS NC	1.2	0.65	10	10
	W4018000300	PIV72IOS NC	1.6	1	8	8
	W4018001200	PIV43IOS NC	1.2	0.65	10	10
	W4018001300	PIV73IOS NC	1.6	1	8	8

#### PIV.T VALVES, OPERATOR Ø 9, ON BASE WITH CONVEYED EXHAUST

Symbol	Code	Description	Air hole Ø [mm]	kv Factor	Pressure range [bar]	
					DC	AC
	W4025002001	PIV73T00 NO	1.6	0.75	0.5 to 7	0.5 to 7
	W4025002501	PIV83T00 NO	1.8	0.85	0 to 6	0.5 to 6.5
	W4025002000	PIV73T00 NC	1.6	0.8	0.5 to 10	0.5 to 10
	W4025002500	PIV83T00 NC	1.8	1	0.5 to 8	0.5 to 8

#### PIV.T VALVES, OPERATOR Ø 9, ON BASE

Symbol	Code	Description	Air hole Ø [mm]	kv Factor	Pressure range [bar]	
					DC	AC
	W4025002101	PIV73T0B NO	1.6	0.75	0.5 to 7	0.5 to 7
	W4025002301	PIV83T0B NO	1.8	0.85	0.5 to 6.5	0.5 to 6.5
	W4025002100	PIV73T0B NC	1.6	0.8	0.5 to 10	0.5 to 10
	W4025002300	PIV83T0B NC	1.8	1	0.5 to 8	0.5 to 8

#### PIV.B VALVES, OPERATOR Ø 13, ON BASE

Symbol	Code	Description	Air hole Ø [mm]	kv Factor	Max oper. pressure [bar]	
					DC	AC
	W4026003000	PIVY3B0S NC	2.4	2.2	8	10

## ACCESSORIES

### MULTIPLE BASES FOR PIV.I SOLENOID VALVES, OPERATOR Ø 8

Code	Description	Abbrev.
W040011101	Base 1 position	EB 6001
W040011102	Base 2 positions	EB 6002
W040011103	Base 3 positions	EB 6003
W040011104	Base 4 positions	EB 6004
W040011105	Base 5 positions	EB 6005
W040011106	Base 6 positions	EB 6006
W040011107	Base 7 positions	EB 6007
W040011108	Base 8 positions	EB 6008
W040011109	Base 9 positions	EB 6009
W040011110	Base 10 positions	EB 6010

### MULTIPLE BASES FOR PIV.T SOLENOID VALVES, OPERATOR Ø 9

Code	Description	Abbrev.
W0400101101	Base 1 position	19001
W0400101102	Base 2 positions	19002
W0400101103	Base 3 positions	19003
W0400101104	Base 4 positions	19004
W0400101105	Base 5 positions	19005
W0400101106	Base 6 positions	19006
W0400101107	Base 7 positions	19007
W0400101108	Base 8 positions	19008
W0400101109	Base 9 positions	19009
W0400101110	Base 10 positions	19010

### MULTIPLE BASES FOR PIV.B VALVES

Code	Description	Abbrev.
W0400101201	Base 1 position	B4001
W0400101202	Base 2 positions	B4002
W0400101203	Base 3 positions	B4003
W0400101204	Base 4 positions	B4004
W0400101205	Base 5 positions	B4005
W0400101206	Base 6 positions	B4006
W0400101207	Base 7 positions	B4007
W0400101208	Base 8 positions	B4008
W0400101209	Base 9 positions	B4009

### MANIFOLD BASES FOR PIV.I SOLENOID VALVES, OPERATOR Ø 8

Code	Description	Abbrev.
W0400111200	Manifold base	EB 8000 I
W0400111201	LH end plate	EB 8000 TI
W0400111202	RH end plate	EB 8000 T2

### BASE BLANKING PLATE FOR PIV.T AND PIV.I VALVES, UNUSED POSITIONS

Code	Description	Abbrev.
W0400112000	Blanking plate	B 6000

### BASE BLANKING PLATE FOR PIV.B VALVES, UNUSED POSITIONS

Code	Description
W0400112001	Blanking plate

### NC/NO ADAPTER FOR PIV.T VALVES

Code	Description	Abbrev.
W0400101190	NC/NO adapter	I-9000

## PIV VALVES IN LINE







TECHNICAL DATA	PIV.I IN LINE	PIV.B IN LINE
Absorption	5W to 5VA	10W - 13VA
Voltage available	12; 24VDC - 24; 110; 220 VAC - 50/60 Hz	24VDC - 24; 110; 220 VAC - 50/60 Hz
Voltage tolerance	%	-10 to 15
Max operating frequency	Hz	15
Solenoid rating	%	100
Response time	ms	10 to 15
Type of protection	IP 65	IP 65
Type of coil	Coil side 22 Ø 8 DIN 43650	Coil side 30 DIN 43650
Insulation class	155	155
Ambient temperature	°C	-15 to 50
Fluid temperature	°C	-15 to 50
Fluid	Filtered lubricated or unlubricated air	Filtered lubricated or unlubricated air
Working life	25 million cycles	-
Weight	35 to 40 (depending on version)	130
Maximum coil/nut torque	Nm	1

**Note on use:**  
The 2/2 NC and 2/2 NO valves work only with inlet pressure  $\geq$  outlet pressure.



### SYNOPTIC, SIZES AND VERSIONS

P I V FAMILY	7 AIR HOLE	2 NUMBER OF WAYS	B CONNECTION	4 THREAD	5 VERSION	N C FURTHER DETAILS
	4 1.2 mm	2 2 ways	I 22 x 22 operator Ø 8	5 M5	S standard	NC normally closed
	7 1.6 mm	3 3 ways	B 30 x 30 operator Ø 13	4 G1/4"		NO normally open
	9 2.4 mm			8 G1/8"		
	W 3 mm					
	X 4 mm					
	Z 6 mm					

### PIV.I VALVES, OPERATOR Ø 8 mm, IN LINE – M5 – 1/8"

Symbol	Code	Description	Input thread	Air hole Ø [mm]	kv Factor	Max oper. pressure [bar]	
						DC	AC
	W4017000100	PIV4215S NC	M5	1.2	0.65	30	30
	W4017001300	PIV9218S NC	G1/8"	2.4	2	6	7
	W4017001100	PIV4218S NC	G1/8"	1.2	0.65	30	30
	W4017001200	PIV7218S NC	G1/8"	1.6	1.2	15	14
	W4017000101	PIV7215S NO	M5	1.4	0.8	10	10
	W4017001201	PIV7218S NO	G1/8"	1.4	0.8	10	10
	W4017003100	PIV4315S NC	M5	1.2	0.65	10	10
	W4017004100	PIV4318S NC	G1/8"	1.2	0.65	10	10
	W4017004200	PIV7318S NC	G1/8"	1.6	1	6.5	6.5
	W4017004201	PIV7318S NO	G1/8"	1.4	0.7	6	7

### PIV.B VALVES, OPERATOR Ø 13, IN LINE

Symbol	Code	Description	Input thread	Ø Air hole [mm]	kv Factor	Max oper. pressure [bar]	
						DC	AC
	W4026005001	PIV73B8S NO	G1/8"	1.6	1.2	6	12
	W4026005101	PIV73B4S NO	G1/4"	1.6	1.2	6	12
	W4026005111	PIV93B4S NO	G1/4"	2.4	2	3	4
	W4026005010	PIV93B8S NC	G1/8"	2.4	2.8	8	10
	W4026005020	PIVW3B8S NC	G1/8"	3	4	5.5	6
	W4026005000	PIV73B8S NC	G1/8"	1.6	1.4	14	17
	W4026005100	PIV73B4S NC	G1/4"	1.6	1.4	14	17
	W4026005110	PIV93B4S NC	G1/4"	2.4	2.8	8	8
	W4026005120	PIVW3B4S NC	G1/4"	3	4	5.5	6
	W4026004000	PIV92B4S NC	G1/4"	2.4	3	15	30
	W4026004010	PIVX2B4S NC	G1/4"	4	7	6	12
	W4026004020	PIVZ2B4S NC	G1/4"	6	9	1.5	5
	W4026004001	PIV92B4S NO	G1/4"	2.4	2.6	13	15

## CNOMO SOLENOID VALVE



#### TECHNICAL DATA

Operating pressure	bar	Max 10
Operating temperature range	°C	-10 to 60
Solenoid rating		100% ED
Fluid		Filtered lubricated or unlubricated air
System		With poppet
Nominal flow rate	l/min	40
TRA/TRR at 6 bar	ms	22/32
Maximum coil nut torque	Nm	10

## ACCESSORIES

### CNOMO MANIFOLD BASE

Code	Description	Code	Description
9453920	Cnomo 3/2 with monostable manual actuation	0227000150	Cnomo manifold base kit
9453922	Cnomo 3/2 with bistable manual actuation	0227000200	Cnomo manifold base input kit



## VALVES MINIMACH

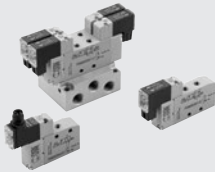



TECHNICAL DATA		
Valve port thread		M5
Type of actuation		electric-pneumatic
Maximum external diameter of fittings	mm	∅ 11
Operating temperature range	°C	-10 to +60
	°F	14 to +140
Fluid		Filtered air without lubrication; lubrication, if used, must be continuous
Pressure range	MPa	0.3 to 0.7
	bar	3 to 7
	psi	44 to 102
Flow rate at 6 bar ΔP 1 3/2	Nl/min	140
Flow rate at 6 bar ΔP 1 5/2	Nl/min	170
Flow rate at 6 bar ΔP 1 5/3	Nl/min	80
Voltage range		24 VDC ± 10%
Power	W	0.9
Solenoid rating		100% ED
Manual operator		Monostable
TRA/TRR 3/2 at 6 bar	ms	8/23
TRA/TRR 5/2 monostable at 6 bar	ms	8/30
TRA/TRR 5/2 bistable at 6 bar	ms	15/15
TRA/TRR 5/3 at 6 bar	ms	9/30
Insulation class		F155
Degree of protection		IP51 for PLUG-IN version IP65 for M8 version
Installation	In any position. As for the bistable ones, if subject to vibration, the vertical assembly is not advisable	

### SYNOPTIC, SIZES AND VERSIONS

M S V	0	5	S O	B	O O	2 4 V D C
FAMILY	DIMENSIONS	FUNCTION	OPERATORS 14	RESETTING (12)	FURTHER DETAILS	
MSV minivalves solenoid	0 M5	3 3/2 5 5/2 6 5/3	SO solenoid	B bistable S mechanical springs	NC normally closed NO normally open OO 5/2 standard CC closed centres OC open centres PC pressure centres	24VDC PLUG-IN 24VDC connector M8 M8 24VDC connector

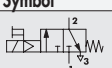
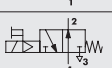
#### MONOSTABLE 3/2

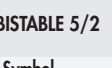
Symbol	Code	Abbrev.	Weight [g]
	7080020532	MSV 03 SOS NC 24VDC	36.2
	708002053M	MSV 03 SOS NC 24VDC M8	36.2
	7080020632	MSV 03 SOS NO 24VDC	36.2
	708002063M	MSV 03 SOS NO 24VDC M8	36.2

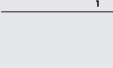

#### MONOSTABLE 5/2

Symbol	Code	Abbrev.	Weight [g]
	7080020132	MSV 05 SOS OO 24VDC	43.3
	708002013M	MSV 05 SOS OO 24VDC M8	43.3

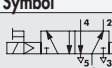
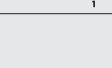
#### BISTABLE 5/2

Symbol	Code	Abbrev.	Weight [g]
	7080020112	MSV 05 SOB OO 24VDC	57
	708002011M	MSV 05 SOB OO 24VDC M8	57

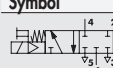
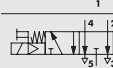
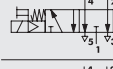
#### MONOSTABLE 5/3

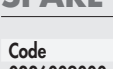
Symbol	Code	Abbrev.	Weight [g]
	7080020212	MSV 06 SOS CC 24VDC	57
	708002021M	MSV 06 SOS CC 24VDC M8	57
	7080020312	MSV 06 SOS OC 24VDC	57
	708002031M	MSV 06 SOS OC 24VDC M8	57
	7080020412	MSV 06 SOS PC 24VDC	57
	708002041M	MSV 06 SOS PC 24VDC M8	57

## ACCESSORIES

Code	Description	Position
0225004600	Adapter for bar omega (Din EN 50022)	
0226009010	Multiple base diaphragm	
0225010201	Base 2 position for 3/2 valves Minimach	2
0225010401	Base 4 position for 3/2 valves Minimach	4
0225010601	Base 6 position for 3/2 valves Minimach	6
0225010801	Base 8 position for 3/2 valves Minimach	8
0226009500	Blanking plate for 3/2 bases Minimach	
0225020201	Base 2 position for 5/2-5/3 valves Minimach	2
0225020401	Base 4 position for 5/2-5/3 valves Minimach	4
0225020601	Base 6 position for 5/2-5/3 valves Minimach	6
0225020801	Base 8 position for 5/2-5/3 valves Minimach	8
0226009501	Blanking plate for 5/2-5/3 bases Minimach	

N.B.: It is advisable to use straight connectors code 02400A

## SPARE PARTS

Code	Description
0226009000	Kit of spare gasket bases for 3/2 valves
0226009001	Kit of spare gasket bases for 5/2-5/3 valves

## MACH 11 VALVES

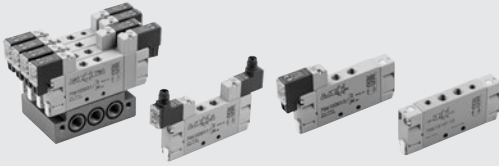

TECHNICAL DATA				
Valve port thread		M7		
Pilot thread		M5		
Maximum external diameter of fittings	mm	Pneumatic: M7 = Ø 11 - M5 = Ø 9 - Electric: M7 - M5 = Ø 11		
Operating temperature range	°C	-10 to +60		
Fluid		Filtered air without lubrication; lubrication, if used, must be continuous		
Screw for valve wall-mounting		M3		
Flow rate at 6 bar ΔP 1 bar	Nl/min	400		
Pressure range	bar	<b>Electric</b>	<b>Electric pilot-assisted</b>	<b>Pneumatic</b>
		monostable: 2 to 7	pilot pressure: 2 to 7	monostable control pres. values: 2 to 10
		bistable: 2 to 7	valve: vacuum to 10	bistable control pres. values: 1 to 10
		5/3: 2 to 7		control pressure 5/3: 2 to 10
				valve: vacuum to 10
Voltage range		24 VDC ± 10%		
Power	W	0.9		
Insulation class		F155		
Degree of protection		IP51 for PLUG-IN version		
		IP65 for M8 version		
Solenoid rating		100% ED		
TRA/TRR monostable at 6 bar	ms	10 / 45		
TRA/TRR bistable at 6 bar	ms	22 / 22		
TRA/TRR 5/3 monostable at 6 bar	ms	22 / 22		

### SYNOPTIC, SIZES AND VERSIONS

M S V	1	5	S O	B	O O	2 4 V D C
FAMILY	DIMENSIONS	FUNCTION	OPERATORS 14	RESETTING (12)	FURTHER DETAILS	
MSV mini-solenoid valve	1 M7	5 5/2 6 5/3	SO solenoid SE solenoid assisted PN pneumatic	B bistable S mechanical springs	OO 5/2 standard closed centres CC closed centres OC open centres PC pressure centres	24VDC PLUG-IN 24VDC connector M8 M8 24VDC connector
MPV mini-pneumatic valve						

## MACH 11 VALVES, PNEUMATIC

### MONOSTABLE 5/2

Symbol	Code	Abbrev.	Weight [g]
	7061010130	MPV 15 PNS OO	52

### BISTABLE 5/2

Symbol	Code	Abbrev.	Weight [g]
	7061010110	MPV 15 PNB OO	52

### MONOSTABLE 5/3

Symbol	Code	Abbrev.	Weight [g]
	7061010210	MPV 16 PNS CC	62
	7061010310	MPV 16 PNS OC	62
	7061010410	MPV 16 PNS PC	62

## MACH 11 VALVES, SOLENOID-PNEUMATIC

### MONOSTABLE 5/2

Symbol	Code	Abbrev.	Weight [g]
	7061020132	MSV 15 SOS OO 24VDC	60
	706102013M	MSV 15 SOS OO 24VDC M8	60
	7061030132	MSV 15 SES OO 24VDC	60
	706103013M	MSV 15 SES OO 24VDC M8	60

### BISTABLE 5/2

Symbol	Code	Abbrev.	Weight [g]
	7061020112	MSV 15 SOB OO 24VDC	72
	706102011M	MSV 15 SOB OO 24VDC M8	72
	7061030112	MSV 15 SEB OO 24VDC	88
	706103011M	MSV 15 SEB OO 24VDC M8	88

### MONOSTABLE 5/3

Symbol	Code	Abbrev.	Weight [g]
	7061020212	MSV 16 SOS CC 24VDC	82
	706102021M	MSV 16 SOS CC 24VDC M8	82
	7061020312	MSV 16 SOS OC 24VDC	82
	706102031M	MSV 16 SOS OC 24VDC M8	82
	7061020412	MSV 16 SOS PC 24VDC	82
	706102041M	MSV 16 SOS PC 24VDC M8	82
	7061030212	MSV 16 SES CC 24VDC	82
	706103021M	MSV 16 SES CC 24VDC M8	82
	7061030312	MSV 16 SES OC 24VDC	82
	706103031M	MSV 16 SES OC 24VDC M8	82
	7061030412	MSV 16 SES PC 24VDC	82
	706103041M	MSV 16 SES PC 24VDC M8	82



## VALVOLE MACH 16

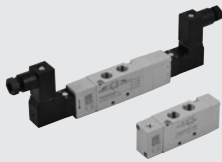

### TECHNICAL DATA

Valve port thread		1/8"
Type of control		M5 pneumatic actuation - Solenoid/pneumatic operation with integrated coil
Maximum outer diameter of gaskets for ports 1 - 3 - 5	mm	15
Maximum outer diameter for ports 2 - 4	mm	15
Operating temperature range	°C	-10 to +60
Minimum pressure pilot-pneumatic controls	bar	Monostable with pneumatic spring: see general catalogue
	bar	1.6 bar for monostable valves - mechanical spring
	bar	1 bar for bistable valves - 1.9 bar for valves 5/3
Operating pressure	bar	vacuum -10
Fluid		Filtered lubricated or unlubricated air lubrication, if used, must be continuous
Recommended lubricant		ISO e UNI FD22
Solenoid pilot		Integrated coil DIN 43650 C shape
Manual		Monostable on solenoid pilot (with bistable manual valve on request)
Number of ways in base		1-3-5 and pilot exhaust
Screws for wall-mounting single valve		2 screws M3
Screws for base-mounting valve		2 screws M2.5x30
Installation		In any position (vertical assembly is not recommended for bistable valves subjected to vibration)

### SYNOPTIC, SIZES AND VERSIONS

M S V FAMILY	2 DIMENSIONS	5 FUNCTION	S O OPERATORS 14	B RESETTING 12	O O FURTHER DETAILS	2 4 V D C VOLTAGE
MSV solenoid/pneumatic	2 1/8"	5 5/2	SO solenoid/pneumatic	P pneumatic spring	OO 5/2	24VDC
MPV pneumatic		6 5/3	SE solenoid pilot	S mechanical springs	CC closed centres	24VAC
			PN pneumatic	B bistable	OC open centres	110VAC
					PC pressure centres	220VAC

## MACH 16 VALVES MPV, PNEUMATIC



### TECHNICAL DATA

Operating pressure	bar	Vacuum to 10
Minimum operating pressure:	bar	
• monostable with pneumatic spring		See general catalogue
• monostable with mechanical spring		1.6
• monostable 5/3		1.9
• bistable		1
Conductance C	NI/min · bar	149.8
Critical ratio b	bar/bar	0.525
Flow rate at 6 bar ΔP 0.5 bar	NI/min	540
Flow rate at 6 bar ΔP 1 bar	NI/min	750
Actuation response times at 6 bar:		
• monostable	ms	4
• bistable	ms	4
Repositioning response times at 6 bar:		
• monostable	ms	8.4
• bistable	ms	4

### MONOSTABLE 5/2

Symbol	Code	Abbrev.	Weight [g]
	7062010100	MPV 25 PNP OO	60
	7062010130	MPV 25 PNS OO	61

### BISTABLE 5/2

Symbol	Code	Abbrev.	Weight [g]
	7062010110	MPV 25 PNB OO	62

### MONOSTABLE 5/3

Symbol	Code	Abbrev.	Weight [g]
	7062010210	MPV 26 PNS CC	73
	7062010310	MPV 26 PNS OC	73
	7062010410	MPV 26 PNS PC	73

## MACH 16 VALVES MPV, SOLENOID/PNEUMATIC



TECHNICAL DATA	
Operating pressure:	bar
• monostable	1.9 to 10
• bistable	1 to 10
• pilot-assisted	Vacuum to 10
Minimum pilot pressure	bar
Operating temperature range	°C
Conductance C	Nl/min · bar
Critical ratio b	bar/bar
Flow rate at 6 bar ΔP 0.5 bar	Nl/min
Flow rate at 6 bar ΔP 1 bar	Nl/min
TRA / TRR monostable at 6 bar	ms
TRA / TRR bistable at 6 bar	ms
Type of operation: Manual	
Pilot with integrated coil	
Power	W
Voltage tolerance	-10% to +15%
Insulation class	F 155
Degree of protection	IP 65 EN60529 with connector
Solenoid rating	100% ED
Electrical contacts	DIN 43650 C shape

### MONOSTABLE 5/2

Symbol	Code	Abbrev.	Weight [g]
	7062020102	MSV 25 SOP OO 24VDC	92
	7062020103	MSV 25 SOP OO 24VAC	92
	7062020104	MSV 25 SOP OO 110VAC	92
	7062020105	MSV 25 SOP OO 220VAC	92
	7062020132	MSV 25 SOS OO 24VDC	93
	7062020133	MSV 25 SOS OO 24VAC	93
	7062020134	MSV 25 SOS OO 110VAC	93
	7062020135	MSV 25 SOS OO 220VAC	93
	7062030132	MSV 25 SES OO 24VDC	93
	7062030133	MSV 25 SES OO 24VAC	93
	7062030134	MSV 25 SES OO 110VAC	93
	7062030135	MSV 25 SES OO 220VAC	93

### BISTABLE 5/2

Symbol	Code	Abbrev.	Weight [g]
	7062020112	MSV 25 SOB OO 24VDC	124
	7062020113	MSV 25 SOB OO 24VAC	124
	7062020114	MSV 25 SOB OO 110VAC	124
	7062020115	MSV 25 SOB OO 220VAC	124
	7062030112	MSV 25 SEB OO 24VDC	125
	7062030113	MSV 25 SEB OO 24VAC	125
	7062030114	MSV 25 SEB OO 110VAC	125
	7062030115	MSV 25 SEB OO 220VAC	125

### MONOSTABLE 5/3

Symbol	Code	Abbrev.	Weight [g]
	7062020212	MSV 26 SOS CC 24VDC	142
	7062020213	MSV 26 SOS CC 24VAC	142
	7062020214	MSV 26 SOS CC 110VAC	142
	7062020215	MSV 26 SOS CC 220VAC	142
	7062020312	MSV 26 SOS OC 24VDC	142
	7062020313	MSV 26 SOS OC 24VAC	142
	7062020314	MSV 26 SOS OC 110VAC	142
	7062020315	MSV 26 SOS OC 220VAC	142
	7062020412	MSV 26 SOS PC 24VDC	142
	7062020413	MSV 26 SOS PC 24VAC	142
	7062020414	MSV 26 SOS PC 110VAC	142
	7062020415	MSV 26 SOS PC 220VAC	142
	7062030212	MSV 26 SES CC 24VDC	143
	7062030213	MSV 26 SES CC 24VAC	143
	7062030214	MSV 26 SES CC 110VAC	143
	7062030215	MSV 26 SES CC 220VAC	143
	7062030312	MSV 26 SES OC 24VDC	143
	7062030313	MSV 26 SES OC 24VAC	143
	7062030314	MSV 26 SES OC 110VAC	143
	7062030315	MSV 26 SES OC 220VAC	143
	7062030412	MSV 26 SES PC 24VDC	143
	7062030413	MSV 26 SES PC 24VAC	143
	7062030414	MSV 26 SES PC 110VAC	143
	7062030415	MSV 26 SES PC 220VAC	143

## MANIFOLD BASES

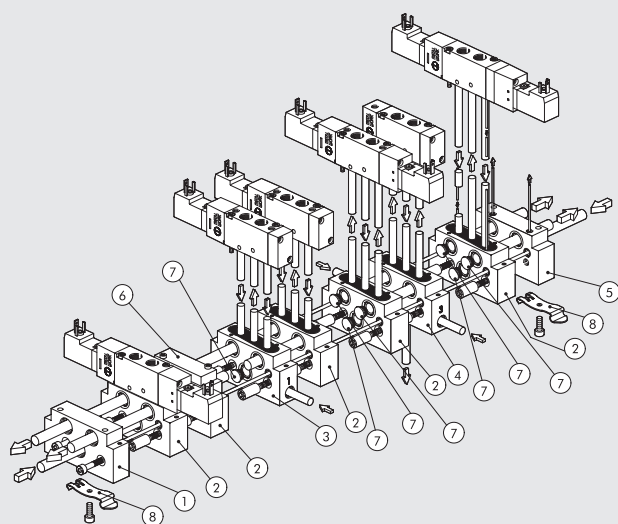

Reference	Code	Description
①	0227100201	Input end-plate kit M16/VDMA
②	0227100150	Manifold base kit M16
③	0227100301	Manifold base kit-separate feed M16
④	0227100302	Manifold base kit-exhaust feed M16
⑤	0227100200	Output end-plate kit M16/VDMA
⑥	0225004500	Accessories - blanking plate for Mach 16
⑦	0227100000	Intermediate diaphragm
⑧	0227300600	Connection bracket on DIN bar

## MULTIPLE BASES FOR MACH 16 VALVES

## SPARE PARTS

### MULTIPLE BASE FOR MACH 16



### INTERMEDIATE DIAPHRAGM



### GASKET KIT (FOR OLD BASES)



Code	Description	N° of posiz.	Weight [g]
0225000201	Base CVM.PN-08-02-0-000	2	180
0225000401	Base CVM.PN-08-04-0-000	4	286
0225000601	Base CVM.PN-08-06-0-000	6	390
0225000801	Base CVM.PN-08-08-0-000	8	500
0225001001	Base CVM.PN-08-10-0-000	10	613
0225001201	Base CVM.PN-08-12-0-000	12	706

Code	Description	Weight [g]
0227100001	Acc. multiple base diaphragm	6

Code	Description	Weight [g]
0226007001	M16 multiple base gasket kit	5

### ADATTATORE BARRA OMEGA (DIN EN 50022)



### KIT OF SPARE INTEGRATED GASKET



Code	Description	Weight [g]
0225004600	Adattatore omega Mach 16	46

Code	Description	Weight [g]
0226007003	M16 multiple base gasket kit	5

## MULTIPLE CONNECTORS MACH 16

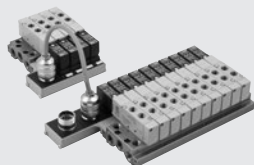

TECHNICAL DATA		
Supply voltage		24VDC - 24VAC
Maximum absorption		50 mA for each position
Valve actuation indicator		Yellow LED
Protection		Fuse
Operating temperature range	°C	-10 to +60
Degree of protection with valves mounted		IP65
Insulation class		In compliance with IEC 664-1 and VDE 0110 Group C
Electromagnetic compatibility		In compliance with EEC 366/89
Maximum number of solenoid valves which can be applied		16
n° of contacts		19, 16 of which for solenoid valves, 2 common and 1 earth
<b>Pre-wired version</b>		
Cable length	m	5
n° of wires		19, 16 of which for solenoid valves, 2 common and 1 earth
Wire section	mm <sup>2</sup>	0,22
Shielding		Tin plated - covering 80 to 90%
Cable		Outer oil-proof and flame-proof PVC sheath
Cable outside diameter	mm	8,5

### SYNOPTIC, SIZES AND VERSIONS

A		0 8		B		W C 5		0 8		M M V L		2 4 V D C	
FAMILY		NO. OF POSITIONS						SIZE				VOLTAGE	
A	multiple base for solenoid/pneumatic connection Mach 16	04	4 posn.	M	electrical connection only for monostable valves	MCN	electrical connection	08	G 1/8"	M	MSV 25 SMS OO	24VDC	
		06	6 posn.							V	MSV 25 SCS OO	24VAC	
		08	8 posn.							L	MSV 25 SMP OO		
		10	10 posn.							J	MSV 25 SMB OO		
		12	12 posn.	B	electrical connection for bistable valves	WC5	pre-wired cable 5 m			K	MSV 25 SCB OO		
B	manifold base for Mach 16 solenoid/pneumatic connection					ACM	additional connection for monostable battery			G	MSV 26 SMS CC		
										O	MSV 26 SCS CC		
										E	MSV 26 SMS OC		
										F	MSV 26 SCS OC		
										B	MSV 26 SMS PC		
										C	MSV 26 SCS PC		
										A	blanking plate		
										D	intermediate diaphragm		

N.B.: The valve insertion order inside the descriptive key is the following, starting from the connector, from the left towards the right: the first left square corresponds to the first valve close to the connector on the base. There are 12 squares available for the description: if you order a base with less than 12 positions, complete by placing a 0 in the remaining boxes.



## MACH 16 VALVES FOR MULTIPLE CONNECTOR

### (M) MONOSTABLE 5/2, SOLENOID/PNEUMATIC - MECHANICAL SPRING

Symbol	Code	Abbrev.	Port	Weight [g]
	7062040132	MSV 25 SMS OO 24VDC	1/8"	92
	7062040133	MSV 25 SMS OO 24VAC	1/8"	92

### (V) MONOSTABLE 5/2, SOLENOID/PNEUMATIC, PILOT-ASSISTED - MECHANICAL SPRING

Symbol	Code	Abbrev.	Port	Weight [g]
	7062060132	MSV 25 SCS OO 24VDC	1/8"	93
	7062060133	MSV 25 SCS OO 24VAC	1/8"	93

### (L) MONOSTABLE 5/2, SOLENOID/PNEUMATIC - PNEUMATIC SPRING

Symbol	Code	Abbrev.	Port	Weight [g]
	7062040102	MSV 25 SMP OO 24VDC	1/8"	93
	7062040103	MSV 25 SMP OO 24VAC	1/8"	93

### (J) BISTABLE 5/2, SOLENOID/PNEUMATIC

Symbol	Code	Abbrev.	Port	Weight [g]
	7062040112	MSV 25 SMB OO 24VDC	1/8"	139
	7062040113	MSV 25 SMB OO 24VAC	1/8"	139

### (K) BISTABLE 5/2, SOLENOID/PNEUMATIC, PILOT-ASSISTED

Symbol	Code	Abbrev.	Port	Weight [g]
	7062060112	MSV 25 SCB OO 24VDC	1/8"	140
	7062060113	MSV 25 SCB OO 24VAC	1/8"	140

### (G) MONOSTABLE 5/3, SOLENOID/PNEUMATIC - CLOSED CENTRES

Symbol	Code	Abbrev.	Port	Weight [g]
	7062040212	MSV 26 SMS CC 24VDC	1/8"	142
	7062040213	MSV 26 SMS CC 24VAC	1/8"	142

### (C) MONOSTABLE 5/3, SOLENOID/PNEUMATIC, PILOT-ASSISTED - CLOSED CENTRES

Symbol	Code	Abbrev.	Port	Weight [g]
	7062060212	MSV 26 SCS CC 24VDC	1/8"	143
	7062060213	MSV 26 SCS CC 24VAC	1/8"	143

### (E) MONOSTABLE 5/3 SOLENOID/PNEUMATIC - OPEN CENTRES

Symbol	Code	Abbrev.	Port	Weight [g]
	7062040312	MSV 26 SMS OC 24VDC	1/8"	142
	7062040313	MSV 26 SMS OC 24VAC	1/8"	142

### (F) MONOSTABLE 5/3 SOLENOID/PNEUMATIC, PILOT-ASSISTED - OPEN CENTRES

Symbol	Code	Abbrev.	Port	Weight [g]
	7062060312	MSV 26 SCS OO 24VDC	1/8"	143
	7062060313	MSV 26 SCS OO 24VAC	1/8"	143

### (B) MONOSTABLE 5/3, SOLENOID/PNEUMATIC - PRESSURE CENTRES

Symbol	Code	Abbrev.	Port	Weight [g]
	7062040412	MSV 26 SMS PC 24VDC	1/8"	142
	7062040413	MSV 26 SMS PC 24VAC	1/8"	142

### (D) MONOSTABLE 5/3, SOLENOID/PNEUMATIC, PILOT-ASSISTED - PRESSURE CENTRES

Symbol	Code	Abbrev.	Port	Weight [g]
	7062060412	MSV 26 SCS PC 24VDC	1/8"	143
	7062060413	MSV 26 SCS PC 24VAC	1/8"	143

## MODULAR MULTIPLE CONNECTOR KIT

### MAIN KIT - VERSION WITH CONNECTOR

Code	Description	Weight [g]
0226500401	Main multiple connection kit, 4 positions 24VDC	245
0226510401	Main multiple connection kit, 4 positions 24VAC	245
0226500601	Main multiple connection kit, 6 positions 24VDC	280
0226510601	Main multiple connection kit, 6 positions 24VAC	280
0226500801	Main multiple connection kit, 8 positions 24VDC	308
0226510801	Main multiple connection kit, 8 positions 24VAC	308
0226501001	Main multiple connection kit, 10 positions 24VDC	344
0226511001	Main multiple connection kit, 10 positions 24VAC	344
0226501201	Main multiple connection kit, 12 positions 24VDC	396
0226511201	Main multiple connection kit, 12 positions 24VAC	396

### SECONDARY KIT

Code	Description	Weight [g]
0226200401	Multiple secondary connector kit, 4 positions 24VDC	166
0226210401	Multiple secondary connector kit, 4 positions 24VAC	166
0226200601	Multiple secondary connector kit, 6 positions 24VDC	210
0226210601	Multiple secondary connector kit, 6 positions 24VAC	210
0226200801	Multiple secondary connector kit, 8 positions 24VDC	257
0226210801	Multiple secondary connector kit, 8 positions 24VAC	257

### MAIN MULTIPLE PRE-WIRED CONNECTION KIT

Code	Description	Weight [g]
0226400401	Pre-wired multiple main connector kit, 4 positions 24VDC	3350
0226410401	Pre-wired multiple main connector kit, 4 positions 24VAC	3350
0226400601	Pre-wired multiple main connector kit, 6 positions 24VDC	3400
0226410601	Pre-wired multiple main connector kit, 6 positions 24VAC	3400
0226400801	Pre-wired multiple main connector kit, 8 positions 24VDC	3423
0226410801	Pre-wired multiple main connector kit, 8 positions 24VAC	3423
0226401001	Pre-wired multiple main connector kit, 10 positions 24VDC	3460
0226411001	Pre-wired multiple main connector kit, 10 positions 24VAC	3460
0226401201	Pre-wired multiple main connector kit, 12 positions 24VDC	3490
0226411201	Pre-wired multiple main connector kit, 12 positions 24VAC	3490

### ADDITIONAL SECONDARY KIT

Code	Description	Weight [g]
0226300401	Multiple secondary connector kit, 4 positions 24VDC	158
0226310401	Multiple secondary connector kit, 4 positions 24VAC	158
0226300601	Multiple secondary connector kit, 6 positions 24VDC	199
0226310601	Multiple secondary connector kit, 6 positions 24VAC	199
0226300801	Multiple secondary connector kit, 8 positions 24VDC	243
0226310801	Multiple secondary connector kit, 8 positions 24VAC	243

## BASES WITH MULTIPLE CONNECTION

### MONOSTABLE SOLENOID/PNEUMATIC BASE WITH 4, 6, 8, 10, 12 POSITIONS

	N. pos.	Description	Code 24VDC	Code 24VAC	Weight [g]
With multiple connector	4	CVM EP 08 04 M MCN . . . . .	0225100401	0225110401	504
	6	CVM EP 08 06 M MCN . . . . .	0225100601	0225110601	644
	8	CVM EP 08 08 M MCN . . . . .	0225100801	0225110801	784
	10	CVM EP 08 10 M MCN . . . . .	0225101001	0225111001	924
	12	CVM EP 08 12 M MCN . . . . .	0225101201	0225111201	1264
With pre-wired cable	4	CVM EP 08 04 M WC5 . . . . .	0225400401	0225410401	3642
	6	CVM EP 08 06 M WC5 . . . . .	0225400601	0225410601	3781
	8	CVM EP 08 08 M WC5 . . . . .	0225400801	0225410801	3923
	10	CVM EP 08 10 M WC5 . . . . .	0225401001	0225411001	4070
	12	CVM EP 08 12 M WC5 . . . . .	0225401201	0225411201	4195

..... : • 24VDC = direct current • 24VAC = alternating current

### BISTABLE SOLENOID/PNEUMATIC BASE WITH 12 POSITIONS

	N. pos.	Description	Code 24VDC	Code 24VAC	Weight [g]
With multiple connector	12	CVM EP 08 12 B MCN . . . . .	0225201201	0225211201	1315
With pre-wired cable	12	CVM EP 08 12 B WC5 . . . . .	0225501201	0225511201	4700

..... : • 24VDC = direct current • 24VAC = alternating current

### BISTABLE SOLENOID/PNEUMATIC BASE WITH 10 POSITIONS

	N. pos.	Description	Code 24VDC	Code 24VAC	Weight [g]
With multiple connector	10	CVM EP 08 10 B MCN . . . . .	0225201001	0225211001	1245
With pre-wired cable	10	CVM EP 08 10 B WC5 . . . . .	0225501001	0225511001	4600

..... : • 24VDC = direct current • 24VAC = alternating current

### BISTABLE SOLENOID/PNEUMATIC BASE WITH 4, 6, 8 POSITIONS

	N. pos.	Description	Code 24VDC	Code 24VAC	Weight [g]
With multiple connector	4	CVM EP 08 04 B MCN . . . . .	0225200401	0225210401	770
	6	CVM EP 08 06 B MCN . . . . .	0225200601	0225210601	965
	8	CVM EP 08 08 B MCN . . . . .	0225200801	0225210801	1200
With pre-wired cable	4	CVM EP 08 04 B WC5 . . . . .	0225500401	0225510401	3910
	6	CVM EP 08 06 B WC5 . . . . .	0225500601	0225510601	4086
	8	CVM EP 08 08 B WC5 . . . . .	0225500801	0225510801	4264

..... : • 24VDC = direct current • 24VAC = alternating current

### ADDITIONAL MONOSTABLE SOLENOID/PNEUMATIC BASE WITH 4, 6, 8 POSITIONS

	N. pos.	Description	Code 24VDC	Code 24VAC	Weight [g]
	4	CVM EP 08 04 M ACM . . . . .	0225300401	0225310401	500
	6	CVM EP 08 06 M ACM . . . . .	0225300601	0225310601	640
	8	CVM EP 08 08 M ACM . . . . .	0225300801	0225310801	780

..... : • 24VDC = direct current • 24VAC = alternating current

## ACCESSORIES FOR MACH 16 MULTIPLE CONNECTOR

#### 10-WIRE RETURN CABLE

Code	Description
0226150022	10-wire return cable L = 22 cm
022615....	10-wire return cable

Please contact our sales offices  
....Length in cm

#### 10-WIRE RETURN CABLE - ONE END WITH CONNECTOR

Code	Description
022613....	10-wire return cable - one end with connector

Please contact our sales offices  
....Length in cm

#### ELECTRIC CONTACT GASKETS

Code	Description
0226107001	Set of electric contact gaskets

Package: 10 pieces

#### 10-WIRE CONNECTOR KIT

Code	Description
0226170002	10-wire connector kit

#### SET OF IDENTIFICATION PLATES

Code	Description
0226107000	Set of identification plates

Package: 16 pieces

#### 19-WIRE CABLE, ONE END WITH CONNECTOR

Code	Description
0226140250	19-wire cable, one end with connector L = 2.5 m
0226140500	19-wire cable, one end with connector L = 5 m
0226141000	19-wire cable, one end with connector L = 10 m
0226141500	19-wire cable, one end with connector L = 15 m
0226142000	19-wire cable, one end with connector L = 20 m
0226143000	19-wire cable, one end with connector L = 30 m

#### CABLE WITH 10 CONNECTORS

Code	Description
0226107201	10-wires cable

Please specify the desired length in metres

#### SET OF MULTIPLE BASE GASKETS

Code	Description
0226007001	Set of M16 multiple base gaskets

#### ELECTRIC CONNECTION BLANKING PLATE

Code	Description
0225004502	Mach 16 electric connection blanking plate

#### BASE BLANKING PLATE

Code	Description
0225004500	Mach 16 base blanking plate

#### MALE CONNECTOR

Code	Description
W0970504021	Male connector 2 mm

Max power for each position = 5W  
Max total power of multiple connector = 36W

#### KIT OF MULTIPLE BASE GASKETS

Code	Description
0226007003	Kit of M16 multiple base integrate gaskets

#### REDUCER WITH GAUGE FOR VALVES, SERIES RMV

Code	Description
9061601	RMV 1/8"

## VALVES TO ISO 15407-1/ VDMA 24563-02 SERIES MACH 18

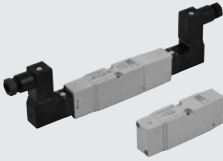

TECHNICAL DATA		
Fluid		Filtered air without lubrication; lubrication, if used, must be continuous
Operating pressure:	bar	
• monostable		1.5 to 10
• monostable 5/3		Vacuum to 10 pneumatic/1.9 to 10 solenoid/pneumatic
• bistable		Vacuum to 10 pneumatic/1 to 10 solenoid/pneumatic
• pilot-assisted		Vacuum to 10
Minimum pilot pressure	bar	2 to 10
Operating temperature range	°C	-10 to +60
Conductance C	Nl/min · bar	114.86
Critical ratio b	bar/bar	0.25
Flow rate at 6 bar ΔP 0.5 bar	Nl/min	340
Flow rate at 6 bar ΔP 1 bar	Nl/min	470
Installation		In any position (vertical assembly is not recommended for bistable valves subjected to vibration)
Assembly		On manifold bases
Recommended lubricant		ISO and UNI FD 22
Solenoid pilot		Integrated coil to DIN 43650 C-shape
Manual		Monostable on solenoid pilot (with manual monostable on request)

### SYNOPTIC, SIZES AND VERSIONS

M S V FAMILY	D DIMENSIONS	5 FUNCTION	S O OPERATORS 14	S RESETTING (12)	O O FURTHER DETAILS	2 4 V D C VOLTAGE
MSV solenoid/pneumatic	D ISO 15407-1/ VDMA 24563-02	5 5/2 6 5/3	SO solenoid/pneumatic SE solenoid-pilot-assisted PN pneumatic	S mechanical springs B bistable	OO 5/2 CC closed centres OC open centres PC pressure centres	24VDC 24VAC 110VAC 220VAC

## MACH 18 ISO 15407-1/VDMA 24563-02 MPV PNEUMATIC



TECHNICAL DATA		
Operating pressure:	bar	Vacuum to 10
Minimum operating pressure:	bar	
• monostable		1.5
• monostable 5/3		1.9
• bistable		1
Conductance C	Nl/min · bar	114.86
Critical ratio b	bar/bar	0.25
Flow rate at 6 bar ΔP 0.5 bar	Nl/min	340
Flow rate at 6 bar ΔP 1 bar	Nl/min	470
Actuation response times at 6 bar:	ms	
• monostable		4
• bistable		4
Repositioning response times at 6 bar:	ms	
• monostable		8.4
• bistable		4
Operating temperature range	°C	-10 + 60

### MONOSTABLE 5/2

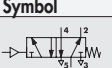
Symbol	Code	Abbrev.	Weight [g]
	7063010130	MPV D5 PNS OO	80

### BISTABLE 5/2

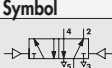
Symbol	Code	Abbrev.	Weight [g]
	7063010110	MPV D5 PNB OO	78

### MONOSTABLE 5/3

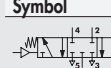
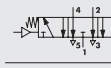
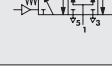
Symbol	Code	Abbrev.	Weight [g]
	7063010210	MPV D6 PNS CC	93
	7063010310	MPV D6 PNS OC	93
	7063010410	MPV D6 PNS PC	93

# MACH 18 ISO 15407-1/VDMA 24563-02 SOLENOID/PNEUMATIC MSV

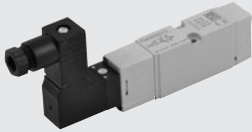

## TECHNICAL DATA

Operating pressure:	bar	1.5 to 10
• monostable		1.9 to 10
• monostable 5/3		1 to 10
• bistable		Vacuum to 10
• pilot-assisted		2
Minimum pilot pressure	bar	-10 to +60
Operating temperature range	°C	114.86
Conductance C	Nl/min · bar	0.25
Critical ratio b	bar/bar	340
Flow rate at 6 bar ΔP 0.5 bar	Nl/min	470
Flow rate at 6 bar ΔP 1 bar	Nl/min	12 / 26
TRA / TRR monostable at 6 bar	ms	21 / 21
TRA / TRR bistable at 6 bar	ms	Monostable on solenoid pilot (with bistable manual valve on request)
Type of manual actuation		24 VDC - 24 VAC - 110 VAC - 220 VAC
Pilot with integrated coil		1
Power	W	-10% to -15%
Voltage tolerance		F 155
Insulation class		IP 65 EN60529 with connector
Degree of protection		100% ED
Solenoid rating		DIN 43650 C Shape
Electrical contacts		

## MONOSTABLE 5/2

Symbol	Code	Abbrev.	Weight [g]
	7063020132	MSV D5 SOS OO 24VDC	110
	7063020133	MSV D5 SOS OO 24VAC	110
	7063020134	MSV D5 SOS OO 110VAC	110
	7063020135	MSV D5 SOS OO 220VAC	110
	7063030132	MSV D5 SES OO 24VDC	110
	7063030133	MSV D5 SES OO 24VAC	110
	7063030134	MSV D5 SES OO 110VAC	110
	7063030135	MSV D5 SES OO 220VAC	110

## MONOSTABLE 5/3

Symbol	Code	Abbrev.	Weight [g]
	7063020212	MSV D6 SOS CC 24VDC	156
	7063020213	MSV D6 SOS CC 24VAC	156
	7063020214	MSV D6 SOS CC 110VAC	156
	7063020215	MSV D6 SOS CC 220VAC	156
	7063020312	MSV D6 SOS OC 24VDC	156
	7063020313	MSV D6 SOS OC 24VAC	156
	7063020314	MSV D6 SOS OC 110VAC	156
	7063020315	MSV D6 SOS OC 220VAC	156
	7063020412	MSV D6 SOS PC 24VDC	156
	7063020413	MSV D6 SOS PC 24VAC	156
	7063020414	MSV D6 SOS PC 110VAC	156
	7063020415	MSV D6 SOS PC 220VAC	156
	7063030212	MSV D6 SES CC 24VDC	156
	7063030213	MSV D6 SES CC 24VAC	156
	7063030214	MSV D6 SES CC 110VAC	156
	7063030215	MSV D6 SES CC 220VAC	156
	7063030312	MSV D6 SES OC 24VDC	156
	7063030313	MSV D6 SES OC 24VAC	156
	7063030314	MSV D6 SES OC 110VAC	156
	7063030315	MSV D6 SES OC 220VAC	156
	7063030412	MSV D6 SES PC 24VDC	156
	7063030413	MSV D6 SES PC 24VAC	156
	7063030414	MSV D6 SES PC 110VAC	156
	7063030415	MSV D6 SES PC 220VAC	156

## BISTABLE 5/2

Symbol	Code	Abbrev.	Weight [g]
	7063020112	MSV D5 SOB OO 24VDC	143
	7063020113	MSV D5 SOB OO 24VAC	143
	7063020114	MSV D5 SOB OO 110VAC	143
	7063020115	MSV D5 SOB OO 220VAC	143
	7063030112	MSV D5 SEB OO 24VDC	143
	7063030113	MSV D5 SEB OO 24VAC	143
	7063030114	MSV D5 SEB OO 110VAC	143
	7063030115	MSV D5 SEB OO 220VAC	143

# BASES TO ISO 15407-1/VDMA 24563-02 FOR MACH 18 VALVES

Reference	Code	Description
①	0227100201	ISO 15407-1 input end plate kit
②	0227200150	ISO 15407-1 manifold base, side ports kit
③	0227200300	ISO 15407-1 intermediate upper ports kit
④	0227100200	ISO 15407-1 output end-plate kit
⑤	0227200500	ISO 15407-1 blanking plate
⑥	0227100000	Intermediate diaphragm
⑦	0227300600	Connection brackets on DIN bar
⑧	0227200800	ISO 15407-1 individual base kit

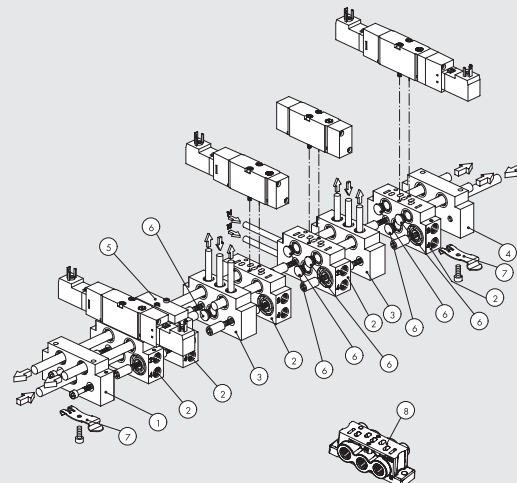

## VALVES ISO 5599/1, SERIES IPV-ISV

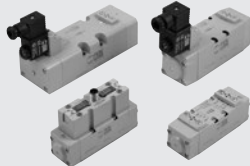

TECHNICAL DATA		ISO 1	ISO 2	ISO 3
Fluid		Filtered air without lubrication; lubrication, if used, must be continuous		
Operating pressure: bar		Vacuum to 10 pneumatic / 2.5 to 10 solenoid/pneumatic		
• monostable		Vacuum to 10 pneumatic / 1 to 10 solenoid/pneumatic		
• bistable		Vacuum to 10		
• pilot-assisted		2.5		
Minimum pilot pressure bar		-10 to +60		
Operating temperature range °C		7.5		
Nominal diameter mm		12		
Conductance C NI/min · bar		15		
Critical ratio b bar/bar		250		
Flow rate at 6 bar ΔP 0.5 bar NI/min		0.36		
Flow rate at 6 bar ΔP 1 bar NI/min		700		
Installation		1100		
Assembly		In any position (vertical assembly is not recommended for bistable valves subjected to vibration)		
Recommended lubricant		On single and manifold bases according to ISO 5599/1		
Solenoid pilot		ISO and UNI FD 22		
Manual		to CNOMO/in-line pilot / M12   to CNOMO		
Maximum coil nut torque Nm		Bistable on solenoid pilot Monostable on valve body 1		

### SYNOPTIC, SIZES AND VERSIONS

I P V FAMILY	5 DIMENSIONS	5 FUNCTION	P N OPERATORS 14	S RESETTING (12)	O O FURTHER DETAILS
IPV ISO pneumatic	5 ISO 1	5 5/2	PN pneumatic	S mechanical springs	OO 5/2
ISV ISO solenoid/pneumatic	6 ISO 2	6 5/3	SO solenoid/pneumatic	B bistable	CC closed centres
	7 ISO 3		SE electric pilot-assisted	D differential	OC open centres
			* DO solenoid/pneumatic in line		PC pressure centres
			* DE solenoid assisted in line M12		
			● CO M12 solenoid/pneumatic		
			● CE M12 solenoid assisted		

\* Only for ISO 1  
● Only for ISO 1 and ISO 2

## VALVES ISO 5599/1, PNEUMATIC SERIES IPV



TECHNICAL DATA		ISO 1	ISO 2	ISO 3
Operating pressure bar		Vacuum to 10		
Minimum operation pressure: bar		2.5		
• monostable		1		
• bistable		-10 to +60		
Operating temperature range °C		7.5		
Nominal diameter mm		12		
Conductance C NI/min · bar		250		
Critical ratio b bar/bar		0.36		
Flow rate at 6 bar ΔP 0.5 bar NI/min		700		
Flow rate at 6 bar ΔP 1 bar NI/min		1100		
Actuation response times at 6 Bar: ms		12		
• monostable		24		
• bistable		35		
Repositioning response times at 6 Bar: ms		20		
• monostable		30		
• bistable		45		
Manual		30		
		43		
		20		
		30		
		45		
		monostable on valve body		

### PNEUMATIC ACTUATION

Symbol	Code	Abbrev.	Weight [g]	Symbol	Code	Abbrev.	Weight [g]
	7051011100	IPV 55 PNS OO ISO 1	310		7051012100	IPV 56 PNS CC ISO 1	310
	7052011100	IPV 65 PNS OO ISO 2	705		7052012100	IPV 66 PNS CC ISO 2	705
	7056011100	IPV 75 PNS OO ISO 3	1175		7056012100	IPV 76 PNS CC ISO 3	1290
	7051011200	IPV 55 PNB OO ISO 1	310		7051012200	IPV 56 PNS OC ISO 1	310
	7052011200	IPV 65 PNB OO ISO 2	705		7052012200	IPV 66 PNS OC ISO 2	705
	7056011200	IPV 75 PNB OO ISO 3	1175		7056012200	IPV 76 PNS OC ISO 3	1290
	7051011300	IPV 55 PND OO ISO 1	310		7051012300	IPV 56 PNS PC ISO 1	310
	7052011300	IPV 65 PND OO ISO 2	705		7052012300	IPV 66 PNS PC ISO 2	705
	7056011300	IPV 75 PND OO ISO 3	1175		7056012300	IPV 76 PNS PC ISO 3	1290

## VALVES ISO 5599/1, SOLENOID/PNEUMATIC, SERIES ISV



TECHNICAL DATA		ISO 1	ISO 2	ISO 3
Operating pressure:	bar		2.5 to 10	
• monostable			1 to 10	
• bistable			Vacuum to 10	
• pilot-assisted			2.5	
Minimum pilot pressure	bar		-10 to +60	
Operating temperature range	°C		12	15
Nominal diameter	mm	7.5	12	15
Conductance C	Nl/min · bar	250	657.14	971.43
Critical ratio b	bar/bar	0.36	0.25	0.43
Flow rate at 6 bar ΔP 0.5 bar	Nl/min	700	1800	3200
Flow rate at 6 bar ΔP 1 bar	Nl/min	1100	2700	4600
TRA / TRR monostable at 6 bar	ms	24 / 50	39 / 60	50 / 120
TRA / TRR bistable at 6 bar	ms	20 / 20	25 / 25	35 / 35
Solenoid pilot		Standards CNOMO		
Manual		Bistable on solenoid pilot		
		Monostable on valve body		
Coils		30 mm side DIN 43650 Form A – ISO		
		22 mm side		
Maximum coil nut torque	Nm	1		

### MONOSTABLE 5/2

Symbol	Code	Abbrev.	Weight [g]
	7051021100	ISV 55 SOS OO ISO 1	344
	7052021100	ISV 65 SOS OO ISO 2	715
	7056021100	ISV 75 SOS OO ISO 3	1207

Symbol	Code	Abbrev.	Weight [g]
	7051021400	ISV 55 SES OO ISO 1	344
	7052021400	ISV 65 SES OO ISO 2	715
	7056021400	ISV 75 SES OO ISO 3	1207

### BISTABLE 5/2 - MONOSTABLE 5/3

Symbol	Code	Abbrev.	Weight [g]
	7051021200	ISV 55 SOB OO ISO 1	388
	7052021200	ISV 65 SOB OO ISO 2	740
	7056021200	ISV 75 SOB OO ISO 3	1230
	7051021300	ISV 55 SOD OO ISO 1	375
	7052021300	ISV 65 SOD OO ISO 2	710
	7056021300	ISV 75 SOD OO ISO 3	1230
	7051022100	ISV 56 SOS CC ISO 1	372
	7052022100	ISV 66 SOS CC ISO 2	720
	7056022100	ISV 76 SOS CC ISO 3	1355
	7051022200	ISV 56 SOS OC ISO 1	372
	7052022200	ISV 66 SOS OC ISO 2	720
	7056022200	ISV 76 SOS OC ISO 3	1355
	7051022300	ISV 56 SOS PC ISO 1	372
	7052022300	ISV 66 SOS PC ISO 2	720
	7056022300	ISV 76 SOS PC ISO 3	1355

Symbol	Code	Abbrev.	Weight [g]
	7051021500	ISV 55 SEB OO ISO 1	388
	7052021500	ISV 65 SEB OO ISO 2	740
	7056021500	ISV 75 SEB OO ISO 3	1230
	7051021600	ISV 55 SED OO ISO 1	375
	7052021600	ISV 65 SED OO ISO 2	710
	7056021600	ISV 75 SED OO ISO 3	1230
	7051022400	ISV 56 SES CC ISO 1	372
	7052022400	ISV 66 SES CC ISO 2	720
	7056022400	ISV 76 SES CC ISO 3	1355
	7051022500	ISV 56 SES OC ISO 1	372
	7052022500	ISV 66 SES OC ISO 2	720
	7056022500	ISV 76 SES OC ISO 3	1355
	7051022600	ISV 56 SES PC ISO 1	372
	7052022600	ISV 66 SES PC ISO 2	720
	7056022600	ISV 76 SES PC ISO 3	1355

## VALVES ISO 5599/1, PNEUMATIC, SERIES ISV WITH IN-LINE SOLENOID PILOT



LOOK ABOVE TABLE FOR TECHNICAL DATA

### MONOSTABLE 5/2 ISO 1

Symbol	Code	Abbrev.	Weight [g]
	7053021100	ISV 55 DOS OO	396
	7053021400	ISV 55 DES OO	396

### BISTABLE 5/2 ISO 1

Symbol	Code	Abbrev.	Weight [g]
	7053021200	ISV 55 DOB OO	450
	7053021500	ISV 55 DEB OO	450

### MONOSTABLE 5/3 ISO 1

Symbol	Code	Abbrev.	Weight [g]
	7053022100	ISV 56 DOS CC	517
	7053022200	ISV 56 DOS OC	516
	7053022300	ISV 56 DOS PC	516

Symbol	Code	Abbrev.	Weight [g]
	7053022400	ISV 56 DES CC	517
	7053022500	ISV 56 DES OC	516
	7053022600	ISV 56 DES PC	515





# VALVES ISO 5599/1, SOLENOID/PNEUMATIC, SERIES ISV WITH M12 CONNECTOR



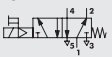
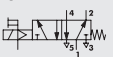

TECHNICAL DATA		ISO 1	ISO 2
Operating pressure:	bar		2.5 to 10 1 to 10 Vacuum to 10
• monostable			2.5
• bistable			-10 to +60
• pilot-assisted			
Minimum pilot pressure	bar		
Operating temperature range	°C		
Nominal diameter	mm	7.5	12
Conductance C	NI/min · bar	250	657.14
Critical ratio b	bar/bar	0.36	0.25
Flow rate at 6 bar ΔP 0.5 bar	NI/min	700	1800
Flow rate at 6 bar ΔP 1 bar	NI/min	1100	2700
TRA / TRR monostable at 6 bar	ms	22 / 60	78 / 180
Solenoid pilot			With built-in coil
Manual			Monostable on solenoid pilot
			Monostable on valve body
Coil power	W		1.2
Voltage			24 VDC ±10%
Electrical connection			M12
Degree of protection			IP65 EN60529
Electrical protection			Transil

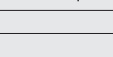
## MONOSTABLE 5/2

Symbol	Code	Abbrev.	Weight [g]	Symbol	Code	Abbrev.	Weight [g]
	7054021100	ISV 55 COS OO ISO 1	508		7054021400	ISV 55 CES OO ISO 1	508
	7055021100	ISV 65 COS OO ISO 2	901		7055021400	ISV 65 CES OO ISO 2	901

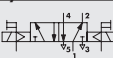
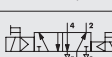
## BISTABLE 5/2 - MONOSTABLE 5/3

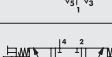
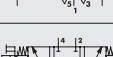
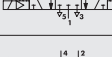
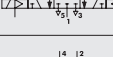
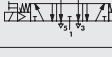
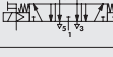
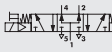
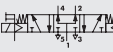
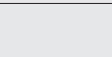
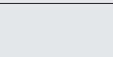
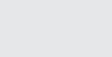
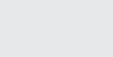
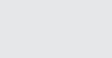
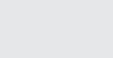
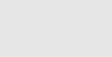
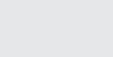
Symbol	Code	Abbrev.	Weight [g]	Symbol	Code	Abbrev.	Weight [g]
	7054021200	ISV 55 COB OO ISO 1	512		7054021500	ISV 55 CEB OO ISO 1	512
	7055021200	ISV 65 COB OO ISO 2	860		7055021500	ISV 65 CEB OO ISO 2	860
	7054021300	ISV 55 COD OO ISO 1	490		7054021600	ISV 55 CED OO ISO 1	490
	7055021300	ISV 65 COD OO ISO 2	860		7055021600	ISV 65 CED OO ISO 2	860
	7054022100	ISV 56 COS CC ISO 1	496		7054022400	ISV 56 CES CC ISO 1	496
	7055022100	ISV 66 COS CC ISO 2	868		7055022400	ISV 66 CES CC ISO 2	868
	7054022200	ISV 56 COS OC ISO 1	496		7054022500	ISV 56 CES OC ISO 1	496
	7055022200	ISV 66 COS OC ISO 2	868		7055022500	ISV 66 CES OC ISO 2	868
	7054022300	ISV 56 COS PC ISO 1	496		7054022600	ISV 56 CES PC ISO 1	496
	7055022300	ISV 66 COS PC ISO 2	868		7055022600	ISV 66 CES PC ISO 2	868

## BASES ISO 5599/1 FOR VALVES SERIES IPV-ISV SIZE 1 AND 2

Reference	Code ISO 1	Code ISO 2	Description
①	0228000150	0228001150	Manifold base - side ports
②	0228000155	0228001155	Manifold base with bottom ports
③	0228000200	0228001200	Input end plate
④	0228000201	0228001201	Additional input end plate
⑤	0228000210	0228001210	Blind end plate
⑥	0228000300	0228001300	Intermediate - top ports
⑦	0228000301	0228001301	Intermediate - back ports
⑧	0228000500	0228001500	Blanking plate
⑨	0228000400	0228001400	Intermediate diaphragm
⑩	0228000600	-	ISO 1/ISO 2 port adapter
⑪	0228000100	0228001100	Individual base - side ports
⑫	0228000110	0228001110	Base - bottom ports
⑬	0228000700	0228001700	Assembly kit

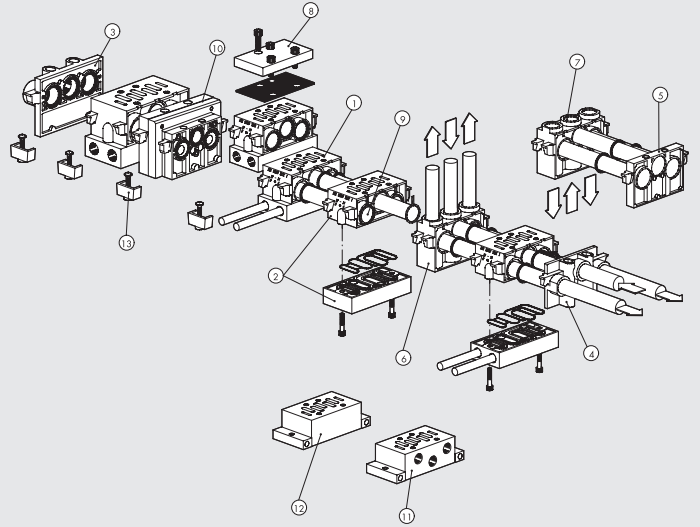

## BASES ISO 5599/1 FOR VALVES SERIES IPV-ISV SIZE ISO 3

Reference	Code ISO 3	Description
②	0228002155	Manifold base with bottom ports
③	0228002200	Input end plate
⑧	0228002500	Blanking plate
⑪	0228002100	Individual base - side ports
⑫	0228002110	Base - bottom ports
⑭	0228002150	Side interface

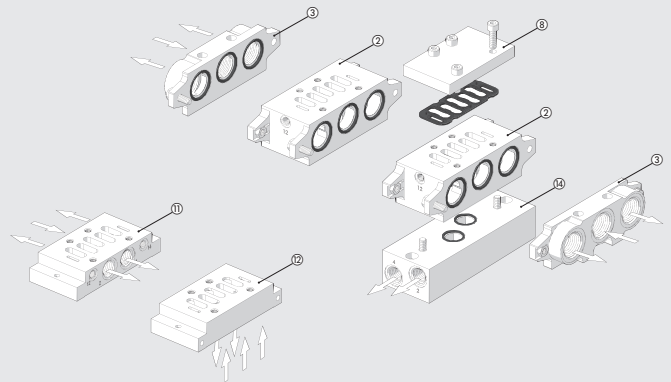

## SANDWICH REGULATORS FOR ISO 5599/1 BASES ISO 1-2



TECHNICAL DATA	ISO 1		ISO 2	
	Max upstream pressure	bar		13
Pressure range	bar		0 to 12	
Pressure gauge range	bar		0 to 12	
Flow rate at $\delta$ bar $\Delta P$ 1 bar	Nl/min		400	
Operating temperature range	°C		-10 to +60	
Fixing screw on ISO 5599/1 base	M5 ant-extraction		M6 ant-extraction	
Installation	In any position			
Instructions for use	Downstream pressure must always be set to increasing values			

### SANDWICH REGULATOR FOR ISO 1 VALVES

Symbol	Code	Description	Weight [g]
	0228000804	Sandwich regulator 1 0 to 12 bar ISO 1	760
	0228000814*	Sandwich regulator 3 0 to 12 bar ISO 1	760

### SANDWICH REGULATOR FOR ISO 2 VALVES

Symbol	Code	Description	Weight [g]
	0228001804	Sandwich regulator 1 0 to 12 bar ISO 2	900
	0228001814*	Sandwich regulator 3 0 to 12 bar ISO 2	900

\* A pilot-assisted valve needs to be used since port 1 relieves pressure, it is not under pressure

\* A pilot-assisted valve needs to be used since port 1 relieves pressure, it is not under pressure



## VALVE SERIES 70 SAFE AIR®

SINGLE



DOUBLE



TECHNICAL DATA	SINGLE VALVE			DOUBLE VALVE		
	1/8"	1/4"	3/8"	1/8"	1/4"	3/8"
Fluid	Filtered unlubricated air (50µm); lubrication, if used, must be continuous					
Operation	3/2 monostable			double 3/2 monostable		
Operating pressure: bar	from 2.5 to 10					
• non-assisted	from vacuum to 10					
• pilot-assisted	2.5					
Minimum pilot pressure bar	from -10 to +60 (from -10 to +45 for ATEX version)					
Operating temperature range °C						
Nominal diameter mm	5	7.5	13.3	-	-	-
Conductance C NI/min · bar	121	264	505	80	202	346
Critical ratio b bar/bar	0.32	0.27	0.32	0.35	0.11	0.24
Flow rate at 6.3 bar Δp 0.5 bar NI/min	390	820	1600	261	561	1038
Flow rate at 6.3 bar Δp 1 bar NI/min	530	1130	2200	358	778	1433
Conductance C on relief NI/min · bar	128	270	491	132	228	491
Critical ratio b on relief bar/bar	0.23	0.29	0.40	0.27	0.21	0.21
Flow rate on free exhaust at 6.3 bar NI/min	900	2050	3550	930	1700	3550
TRA/TRR α 6.3 bar ms/ms	15 / 35	19 / 45	21 / 72	28 / 35	38 / 45	50 / 72
Installation	Any position					
Assembly	In-line					
Manual actuator	Monostable					
Recommended lubricant	ISO and UNI FD 22					
Compatibility with oils	See www.metalwork.it/ita/materiali_compatibilita.html					
Coils	22 mm side, ø 8 hole – EN175301-803 connection, type B Certified EN 60204.1 and VDE 0580					
Class of protection	Refer to the Accessories section for the electrical features page 122*					
Noise level	IP65 with coil and connector mounted					
Max coil ring nut torque Nm	Max. 78 dBA with silenced relief					
CE marking	1					
ATEX category (only for versions with an ATEX sensor)	In accordance with Machinery Directive, Annex V (**) ⊕ II 3G Ex nA c IIC T4 Gc x -10°C<Ta<45°C ⊕ II 3D Ex tc IIIC T135°C IP65 Dc					
Safety function	Cuts off the power supply and relieves the air circuit connected to port 2					
Type of sensor used	Hall effect (refer to page 77 for sensor details)					
B10d	40 x 10 <sup>6</sup> cycles					
Category - ISO EN 13849	2			4		
DC	Low (80 %)			High (≥ 99 %)		
CCF	-			80		
PL - ISO EN 13849	Suitable for use in safety circuits up to PL=c			Suitable for use in safety circuits up to PL = e		
IMPORTANT	Do not mount 2 or more SAFE AIR® valves in adjacent positions. When mounting valves side by side, the minimum distance is specified in the user manual.					

\* To avoid malfunctions, we recommend using Metal Work accessories

\*\* The declaration can be downloaded from www.metalwork.it

**IMPORTANT:** Any ferromagnetic masses must be at least 40 mm from the sensor.  
Prevent magnetic fields from creating disturbance in the sensor area.

### SYNOPTIC, SIZES AND VERSIONS

SOV FAMILY	2 DIMENSIONS	3 FUNCTION	SO OPERATORS 14	S RESETTING 12	NC FURTHER DETAILS	3 F SENSOR
SOV solenoid/pneumatic	2 1/8" 3 1/4" C 3/8"	3 3/2	SO solenoid/pneumatic SE electric pilot-assisted	S mechanical springs	NC Normally-Closed DD Double 3/2	3F 2.5 m 3 wires M8 0.3 m M8 AT 2 m ATEX

### SINGLE VALVE SERIES 70 SAFE AIR®

Symbol	Code	Abbrev.	Sensor	Weight [g]	Symbol	Code	Abbrev.	Sensor	Weight [g]
	7015020200	SOV 23 SOS NC 3F 1/8"	2.5 m 3 wires	182		7015020500	SOV 23 SES NC 3F 1/8"	2.5 m 3 wires	182
	7015120200	SOV 23 SOS NC M8 1/8"	0.3 m M8	178		7015120500	SOV 23 SES NC M8 1/8"	0.3 m M8	178
	7015220200	SOV 23 SOS NC AT 1/8"	2 m ATEX	174		7015220500	SOV 23 SES NC AT 1/8"	2 m ATEX	174
	7025020200	SOV 33 SOS NC 3F 1/4"	2.5 m 3 wires	252		7025020500	SOV 33 SES NC 3F 1/4"	2.5 m 3 wires	252
	7025120200	SOV 33 SOS NC M8 1/4"	0.3 m M8	248		7025120500	SOV 33 SES NC M8 1/4"	0.3 m M8	248
	7025220200	SOV 33 SOS NC AT 1/4"	2 m ATEX	244		7025220500	SOV 33 SES NC AT 1/4"	2 m ATEX	244
	7045020200	SOV C3 SOS NC 3F 3/8"	2.5 m 3 wires	402		7045020500	SOV C3 SES NC 3F 3/8"	2.5 m 3 wires	402
	7045120200	SOV C3 SOS NC M8 3/8"	0.3 m M8	398		7045120500	SOV C3 SES NC M8 3/8"	0.3 m M8	398
	7045220200	SOV C3 SOS NC AT 3/8"	2 m ATEX	394		7045220500	SOV C3 SES NC AT 3/8"	2 m ATEX	394

### DOUBLE VALVE SERIES 70 SAFE AIR®

Symbol	Taille	Abbrev.	Sensor	Weight [g]
7015020210	1/8"	SOV 23 SOS DD 3F	2.5 m 3 wires	482
7015120210	1/8"	SOV 23 SOS DD M8	0.3 m M8	479
7015220210	1/8"	SOV 23 SOS DD AT	2 m ATEX	466
7015020510	1/8"	SOV 23 SES DD 3F	2.5 m 3 wires	482
7015120510	1/8"	SOV 23 SES DD M8	0.3 m M8	474
7015220510	1/8"	SOV 23 SES DD AT	2 m ATEX	466
7025020210	1/4"	SOV 33 SOS DD 3F	2.5 m 3 wires	632
7025120210	1/4"	SOV 33 SOS DD M8	0.3 m M8	624
7025220210	1/4"	SOV 33 SOS DD AT	2 m ATEX	616
7025020510	1/4"	SOV 33 SES DD 3F	2.5 m 3 wires	632
7025120510	1/4"	SOV 33 SES DD M8	0.3 m M8	624
7025220510	1/4"	SOV 33 SES DD AT	2 m ATEX	616
7045020210	3/8"	SOV C3 SOS DD 3F	2.5 m 3 wires	972
7045120210	3/8"	SOV C3 SOS DD M8	0.3 m M8	964
7045220210	3/8"	SOV C3 SOS DD AT	2 m ATEX	956
7045020510	3/8"	SOV C3 SES DD 3F	2.5 m 3 wires	972
7045120510	3/8"	SOV C3 SES DD M8	0.3 m M8	964
7045220510	3/8"	SOV C3 SES DD AT	2 m ATEX	956

### WIRING DIAGRAM

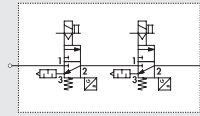

### ACCESSORIES

#### SY1 - SY2 KIT FOR CONNECTION TO SERIE 70 SAFE AIR® VALVES

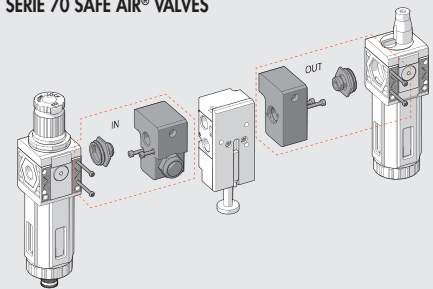

Symbol	Description
9210015	IN 1/4 SY1 block accessory
9210016	OUT 1/4 SY1 block accessory
9210017	IN 3/8 SY2 block accessory
9210018	OUT 3/8 SY2 block accessory

Max torque for screw, 0.4 Nm for SY1  
Max torque for screw, 2.5 Nm for SY2

VALVES

### VALVES ISO 5599/1 SERIES SAFE AIR®

SINGLE



DOUBLE



#### TECHNICAL DATA

	SINGLE VALVE			DOUBLE VALVE		
	ISO 1	ISO 2	ISO 3	ISO 1	ISO 2	ISO 3
Fluid	Filtered un lubricated air (50µm); lubrication, if used, must be continuous					
Operation	5/2 monostable					
Operating pressure:	bar					
• non-assisted	from 2.5 to 10					
• pilot-assisted	from vacuum to 10					
Minimum pilot pressure	bar					
Operating temperature range	°C					
Nominal diameter	mm					
Conductance C	NI/min · bar					
Critical ratio b	bar/bar					
Flow rate at 6.3 bar Δp 0.5 bar	NI/min					
Flow rate at 6.3 bar Δp 1 bar	NI/min					
Conductance C on relief	NI/min · bar					
Critical ratio b on relief	bar/bar					
Flow rate on free exhaust at 6.3 bar	NI/min					
TRA/TRR α 6.3 bar	ms/ms					
Installation	Any position					
Assembly	On single or manifold bases to ISO 5599/1 (*)					
Solenoid pilot	to CNOMO					
Manual actuator	Monostable on solenoid pilot and valve body					
Recommended lubricant	ISO and UNI FD 22					
Coils	30 mm side, ø 8 hole - EN175301-803 connection, type A					
	22 mm side, ø 8 hole - EN175301-803 connection, type B					
	Certified EN 60204.1 and VDE 0580					
	Refer to the Accessories section for the electrical features page 122*					
Class of protection	IP65 with coil and connector mounted					
Noise level	Max. 78 dBA with silenced relief					
Max coil ring nut torque	Nm					
CE marking	1					
ATEX category (only for versions with an ATEX sensor)	In accordance with Machinery Directive, Annexe V (**)					
	⊕ II 3G Ex nA c IIC T4 Gc x -10°C<Ta<45°C					
	⊕ II 3D Ex tc IIC T1 35°C IP65 Dc					
Safety function	Cuts off the power supply and relieves the air circuit connected to port 4					
Type of sensor used	Hall effect (refer to page 77 for sensor details)					
B10d	40 x 10 <sup>6</sup> cycles					
Category - ISO EN 13849	2			4		
DC	Low (80 %)			High (≥ 99 %)		
CCF	-			80		
PL - ISO EN 13849	Suitable for use in safety circuits up to PL=c			Suitable for use in safety circuits up to PL= e		
IMPORTANT	Do not mount 2 or more SAFE AIR® valves in adjacent positions.					

\* To avoid malfunctions, we recommend using Metal Work accessories

\*\* The declaration can be downloaded from [www.metalwork.it](http://www.metalwork.it)

**IMPORTANT:** Any ferromagnetic masses must be at least 30 mm from the sensor.  
Prevent magnetic fields from creating disturbance in the sensor area.

**SYNOPTIC, SIZES AND VERSIONS**

IS V FAMILY		5 DIMENSIONS		5 FUNCTION		S O OPERATORS 14		S RESETTING 12		O O FURTHER DETAILS		3 F SENSOR	
ISV	ISO solenoid/pneumatic	5	ISO1	5	5/2	SO	solenoid/pneumatic	S	mechanical springs	OO	5/2	3F	2.5 m 3 wires
		6	ISO2			SE	electric pilot-assisted			DD	Double 3/2	M8	0.3 m M8
		7	ISO3									AT	2 m ATEX

**SINGLE VALVE ISO 5599/1 SERIES SAFE AIR®**

Symbol	Code	Abbrev.	Sensor	Weight [g]
	7057021100	ISV 55 SOS OO 3F ISO 1	2.5 m 3 wires	380
	7057121100	ISV 55 SOS OO M8 ISO 1	0.3 m M8	350
	7057221100	ISV 55 SOS OO AT ISO 1	2 m ATEX	370
	7058021100	ISV 65 SOS OO 3F ISO 2	2.5 m 3 wires	750
	7058121100	ISV 65 SOS OO M8 ISO 2	0.3 m M8	720
	7058221100	ISV 65 SOS OO AT ISO 2	2 m ATEX	740
	7059021100	ISV 75 SOS OO 3F ISO 3	2.5 m 3 wires	1240
	7059121100	ISV 75 SOS OO M8 ISO 3	0.3 m M8	1210
	7059221100	ISV 75 SOS OO AT ISO 3	2 m ATEX	1230

Symbol	Code	Abbrev.	Sensor	Weight [g]
	7057021400	ISV 55 SES OO 3F ISO 1	2.5 m 3 wires	380
	7057121400	ISV 55 SES OO M8 ISO 1	0.3 m M8	350
	7057221400	ISV 55 SES OO AT ISO 1	2 m ATEX	370
	7058021400	ISV 65 SES OO 3F ISO 2	2.5 m 3 wires	750
	7058121400	ISV 65 SES OO M8 ISO 2	0.3 m M8	720
	7058221400	ISV 65 SES OO AT ISO 2	2 m ATEX	740
	7059021400	ISV 75 SES OO 3F ISO 3	2.5 m 3 wires	1240
	7059121400	ISV 75 SES OO M8 ISO 3	0.3 m M8	1210
	7059221400	ISV 75 SES OO AT ISO 3	2 m ATEX	1230

**DOUBLE VALVE ISO 5599/1 SERIES SAFE AIR®**

Code	Size	Abbrev.	Sensor	Weight [g]
7057021110	ISO 1	ISV 55 SOS DD 3F	2.5 m 3 wires	2100
7057121110	ISO 1	ISV 55 SOS DD M8	0.3 m M8	2100
7057221110	ISO 1	ISV 55 SOS DD AT	2 m ATEX	2100
7057021410	ISO 1	ISV 55 SES DD 3F	2.5 m 3 wires	2100
7057121410	ISO 1	ISV 55 SES DD M8	0.3 m M8	2100
7057221410	ISO 1	ISV 55 SES DD AT	2 m ATEX	2100
7058021110	ISO 2	ISV 65 SOS DD 3F	2.5 m 3 wires	4000
7058121110	ISO 2	ISV 65 SOS DD M8	0.3 m M8	4000
7058221110	ISO 2	ISV 65 SOS DD AT	2 m ATEX	4000
7058021410	ISO 2	ISV 65 SES DD 3F	2.5 m 3 wires	4000
7058121410	ISO 2	ISV 65 SES DD M8	0.3 m M8	4000
7058221410	ISO 2	ISV 65 SES DD AT	2 m ATEX	4000
7059021110	ISO 3	ISV 75 SOS DD 3F	2.5 m 3 wires	5300
7059121110	ISO 3	ISV 75 SOS DD M8	0.3 m M8	5300
7059221110	ISO 3	ISV 75 SOS DD AT	2 m ATEX	5300
7059021410	ISO 3	ISV 75 SES DD 3F	2.5 m 3 wires	5300
7059121410	ISO 3	ISV 75 SES DD M8	0.3 m M8	5300
7059221410	ISO 3	ISV 75 SES DD AT	2 m ATEX	5300

**WIRING DIAGRAM**

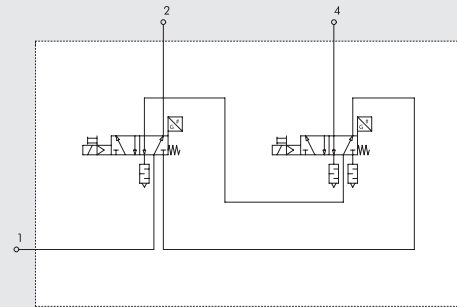

**NOTES**

Blank area for notes.

**VALVES**  
VALVES ISO 5599/1 SERIES SAFE AIR®



## COILS AND CONNECTORS L=15 MM, L=22 MM, L=30 MM

### COILS SIDE 22 mm

- Voltage tolerance: -10 to +15%
- Insulation class: F155
- Degree of protection: IP65 - EN60529 with connector
- Avoid prolonged exposure to the atmospheric agents.
- Maximum coil temperature at 100% use: 55°C at 20° ambient temperature (70° ± 10° per operator Ø 9)
- According to ATEX 94/9 CE rule, group II, category 3 GD (Only standard version)



### STANDARD

Code	Abbrev.	Nominal voltage	Absorption	
			Inrush	Holding
<b>COILS FOR PIV.I SOLENOID VALVES</b>				
W021500051	Coil 22 Ø 8 5W-12VDC	12VDC	5W	5W
W021500001	Coil 22 Ø 8 5W-24VDC	24VDC	5W	5W
W021500011	Coil 22 Ø 8 5VA-24VAC	24V 50/60Hz	8VA	5VA
W021500021	Coil 22 Ø 8 5VA-110VAC	110V 50/60Hz	8VA	5VA
W021500031	Coil 22 Ø 8 5VA-220VAC	220V 50/60Hz	8VA	5VA

### COILS FOR SERIES 70 SOLENOID VALVES - ISO 5599/1

W0215000151	Coil 22 Ø 8 BA 2W-12VDC	12VDC	2W	2W
W0215000101	Coil 22 Ø 8 BA 2W-24VDC	24VDC	2W	2W
W0215000111	Coil 22 Ø 8 BA 3.5VA-24VAC	24V 50/60Hz	5.3VA	3.5VA
W0215000121	Coil 22 Ø 8 BA 3.5VA-110VAC	110V 50/60Hz	5.3VA	3.5VA
W0215000131	Coil 22 Ø 8 BA 3.5VA-220VAC	220V 50/60Hz	5.3VA	3.5VA

### COILS FOR PIV.T SOLENOID VALVES, OPERATOR Ø 9

W0216000001	Coil 22 Ø 9 3.8W-24VDC	24VDC	3.8W	3.8W
W0216000011	Coil 22 Ø 9 6.5VA-24VAC	24V 50/60Hz	9VA	6.5VA
W0216000021	Coil 22 Ø 9 6.5VA-110VAC	110V 50/60Hz	9VA	6.5VA
W0216000031	Coil 22 Ø 9 6.5VA-220VAC	220V 50/60Hz	9VA	6.5VA

### "UL" AND "CSA" COILS 22 mm FOR SERIES 70 - NAMUR - ISO 5599/1 - CNOMO



Code	Abbrev.	Nominal voltage	Absorption	
			Inrush	Holding
W0215000251	Coil 22 Ø 8 BA 2W-12VDC UR	12VDC	2W	2W
W0215000201	Coil 22 Ø 8 BA 2W-24VDC UR	24VDC	2W	2W
W0215000211	Coil 22 Ø 8 BA 3.5VA-24VAC UR	24V 50/60Hz	5.3VA	3.5VA
W0215000221	Coil 22 Ø 8 BA 3.5VA-110VAC UR	110V 50/60Hz	5.3VA	3.5VA
W0215000231	Coil 22 Ø 8 BA 3.5VA-220VAC UR	220V 50/60Hz	5.3VA	3.5VA

### COILS SIDE 30 mm FOR PIV.B SOLENOID VALVES

- Voltage tolerance: -10 to +15%
- Insulation class: M180
- Degree of protection: IP65 - EN60529 with connector
- Avoid prolonged exposure to the atmospheric agents
- According to ATEX 94/9 CE rule, group II, category 3 GD



Code	Abbrev.	Nominal voltage	Power absorption (average power input)	
			Inrush	Holding
W0216001001	Coil 30 Ø13 10W-24VDC	24Vcc	10W	
W0216001011	Coil 30 Ø13 13VA-24VAC	24V 50/60Hz	13VA	
W0216001021	Coil 30 Ø13 13VA-110VAC	110V 50/60Hz	13VA	
W0216001031	Coil 30 Ø13 13VA-220VAC	220V 50/60Hz	13VA	

### COILS, SIDE 30 mm FOR SOLENOID VALVES ISO 5599/1 - CNOMO

- Electric contact DIN 43650 Shape A
- Voltage tolerance: -10% to +10%
- Insulation class: F155
- Degree of protection: IP65 EN 60529 with connector
- Solenoid rating: 100% ED
- Maximum coil temperature at 100% ED use 70°C at 20° ambient temperature

Code	Abbrev.	Nominal voltage	Absorption	
			Inrush	Holding
W0210010100	Coil 30 Ø8 2W-24VDC	24Vcc	5W	2W
W0210011100	Coil 30 Ø8 3.5VA-24VAC	24V 50/60Hz	10VA	3.5VA
W0210012100	Coil 30 Ø8 3.5VA-110VAC	110V 50/60Hz	10VA	3.5VA
W0210013100	Coil 30 Ø8 3.5VA-220VAC	220V 50/60Hz	10VA	3.5VA

### KIT COIL EEXM FOR SERIES 70 - ISO 5599/1 - ATEX

- According to ATEX 94/9 CE rule,  
 Ⓢ II 2G Ex mb IIC T4/T5 Gb  
 Ⓢ II 2D Ex tb IIIC T130/T95 °C IP66 Db



Code	Description
0227606913	Kit for coil 30 24VDC EEXMT5 cable 3 m
0227606915	Kit for coil 30 24VDC EEXMT5 cable 5 m
0227608013	Kit for coil 30 24VAC EEXMT5 cable 3 m
0227608015	Kit for coil 30 24VAC EEXMT5 cable 5 m
0227608023	Kit for coil 30 110VAC EEXMT5 cable 3 m
0227608025	Kit for coil 30 110VAC EEXMT5 cable 5 m
0227608033	Kit for coil 30 230VAC EEXMT5 cable 3 m
0227608035	Kit for coil 30 230VAC EEXMT5 cable 5 m

### KIT COILS SIDE 22 IP65 FOR SERIES 70 - ISO 5599/1

- Improved IP65 protection, even after prolonged exposure to atmospheric agents.  
 Applicable to valves with a technopolymer control.



Code	Description
0222100100	Kit for coils 22 - IP65

### CONNECTOR 15 mm SHAPE C TO DIN 43650 FOR SOLENOID VALVES MACH 16 - MACH 18



Code	Description
W0970501021	Connector 15 mm shape C DIN 43650
W0970501022	Connector 15 mm shape C DIN 43650 LED 24V
W0970501025	Connector 15 mm shape C DIN 43650 LED+VDR 24V

### COIL CONNECTORS, SIDE 22 mm FOR SOLENOID VALVES PIV.I - PIV.T - SERIES 70 - ISO 5599/1

Code	Type	Colour	Ø Cable
W0970510011	Standard	22 mm	Black PG9
W0970510012	LED 24V	22 mm	Transparent PG9
W0970510013	LED 110V	22 mm	Transparent PG9
W0970510014	LED 220V	22 mm	Transparent PG9
W0970510015	LED + VDR 24V	22 mm	Transparent PG9
W0970510016	LED + VDR 110V	22 mm	Transparent PG9
W0970510017	LED + VDR 220V	22 mm	Transparent PG9
W0970510070	Atex II 2 GD	22 mm	Black PG9

### CONNECTORS, SIDE 30 mm FOR SOLENOID VALVES PIV.B - ISO 5599/1 - CNOMO

Code	Type	Colour	Ø Cable
W0970520033	Standard	30 mm	Black PG11
W0970520034	LED 24V	30 mm	Transparent PG11
W0970520035	LED 110V	30 mm	Transparent PG11
W0970520036	LED 220V	30 mm	Transparent PG11
W0970520037	LED + VDR 24V	30 mm	Transparent PG11
W0970520038	LED + VDR 110V	30 mm	Transparent PG11
W0970520039	LED + VDR 220V	30 mm	Transparent PG11

### PLUG-IN CONNECTOR FOR SOLENOID VALVES MINIMACH - MACH 11 - PLT 10

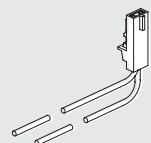

Code	Description
W0970512000	MACH 11 PLUG-IN connector L = 300





## EB 80 ELECTRO-PNEUMATIC SYSTEM



VALVES

EB 80 ELECTRO-PNEUMATIC SYSTEM

TECHNICAL DATA							
Supply voltage range	V	12 -10%		24 +30%			
Minimum operating voltage	V			10,8 *			
Maximum operating voltage	V			31.2			
Maximum admissible voltage	V			32 ***			
Power for each controlled pilot	W	3 for 15 ms, then holding 0.3		PNP or NPN		100% ED	
Drive (for multi-pole)				See chapter "Electrical connection - E"			
Solenoid rating				See chapter "Signal module - S"			
Solenoid valve supply power				Overload and short-circuit protected solenoid pilot Output			
Signal module supply power				See chapter "Electrical connection - E"			
Protection				21 or 38 multi-pole connection; field bus 128			
Diagnostics				-10 to + 50 (at 8 bar)			
Maximum number of solenoid pilots				14 to 122 (at 8 bar)			
Ambient temperature	°C						
	°F						
Operating pressure		<b>5/2 and 5/3</b>				<b>2/2 and 3/2</b>	
Non-assisted valves	bar	3 to 8				3.5 to 8	
	MPa	0.3 to 0.8				0.35 to 0.8	
	psi	43 to 116				51 to 116	
Assisted valves	bar			Vacuum to 10			
	MPa			Vacuum to 1			
	psi			Vacuum to 145			
Servo pressure	bar	3 to 8				min. (see graph on general catalogue) / max. 8	
	MPa	0.3 to 0.8				min. (see graph on general catalogue) / max. 0.8	
	psi	43 to 116				min. (see graph on general catalogue) / max. 116	
Valve flow rate, at 6.3 bar ΔP 1 bar		<b>Ø 4 [5/32"]</b>	<b>Ø 6</b>	<b>Ø 8 [5/16"]</b>	<b>Ø 1/4"</b>	<b>Ø 10 **</b>	<b>Ø 3/8" **</b>
	valve 2/2 NI/min	350	430	500	430	-	-
	valve 3/2 NI/min	350	600	700	600	1250	1250
	valve 5/2 NI/min	350	650	800	650	1250 - 1400	1250 - 1400
	valve 5/3 NI/min	350	460	500	460	1000 - 1250	1000 - 1250
	valve V3V (R) NI/min	-	-	-	-	1000	1000
Actuation response time (TRA) / reset response time (TRR) at 6 bar				14 / 28			
	TRA/TRR valve 2/2 and 3/2			12 / 45			
	TRA/TRR valves 5/2 monostable and shut-off valve			12 / 14			
	TRA/TRR valve 5/2 bistable			15 / 45			
	TRA/TRR valve 5/3			13 / 36			
	TRA/TRR valve 3/2 high flow			Unlubricated air			
Fluid				ISO 8573-1 class 4-7-3			
Air quality required				IP65 (with connectors connected or plugged if not used)			
Degree of protection							

\* Minimum voltage 10.8V required at solenoid pilots. Check the minimum voltage at the power supply output using the calculations shown on general catalogue

\*\* Using high-flow valves or connected valves.

\*\*\* IMPORTANT! Voltage greater than 32VDC will damage the system irreparably.

N.B.: Refer to the chapter of each EB 80 sub-assembly for specific technical data.

### KEY TO CODES

A complete system has a compound description of all its subsystems listed in sequence from left to right, as shown below.

The abbreviation of each subsystem is obtained by taking the code and omitting the first digits 02282.

For example: the digital 8-input signal module is identified with code 02282S01; only write S01 in the description.

The abbreviation of each base for valves consists of:

Abbreviation of the Base	Manual valve control	Type of valves
Obtained from the code, after removing 02282	0 = monostable 1 = bistable	Valves Dummy valve Bypass
<b>Example</b>		
4-position base, 8 solenoid pilots, Ø 6 pipe; code 02282B4086666	Monostable	2 monostable 5/2 valves - V 1 double 3/2 NO - W 1 dummy valve - F
<b>Abbreviation</b>		
B4086666	0	VVWF

The description is therefore a sequence of this type:

EB 80	- S _	- E _ _	- P _ _ _	- B _ _ _ _	- M _ _ _ _	- C _
EB 80 system	Signal module (if present)	Electrical connection	Compressed air supply	Base for valves (as many as there are) with normal or dummy	Intermediate (if present)	Closed end-plate

Example: EB 80-S01-E0EN-P3XZ00-B4086660VWKN-M300Z30-B30388800VVN-C2

EB 80	- S01	- E0EN	- P3XZ00	- B4086660VWKN	- M300Z30	- B30388800VVN	- C2
EB 80 system	Signal module complete 8 M8 digital inputs	Electrical connection EtherNet/IP	Compressed air supply - fitting Ø 12 - pilot servo Ø 4 - silenced relief	Base for valves - 4 positions - 8 controls - fittings for pipe Ø 6 - manual monostable control - 5/2 monostable valve - 2 3/2 NO valves - bistable 5/2 valve - dummy valve	Intermediate - fittings for pipe Ø 12 - through ports - without supplementary power supply	Base - 3 positions - 3 controls - fittings for pipe Ø 8 - manual monostable control - 5/2 monostable valve - 5/2 monostable valve - dummy valve	Closed end-plate for valve Island with field bus

Endless number of EB 80 systems can be obtained and their description is variable in length, which can be very extended. The actual ordering CODE of an EB 80 system is created by Metal Work S.p.A. with a limited number of characters. The ordering code is not explicative. The description only is univocal, complete and explicative.

## EB 80 SIGNAL MODULES - S



TECHNICAL DATA	
Supply voltage range	V 12 -10% 24 +30%
Minimum operating voltage	V 10.8 *
Maximum operating voltage	V 31.2
Maximum admissible voltage	V 32 ***
Power and current	see individual "Signal Modules - S"
Protection	Overload and polarity inversion protection
Diagnostics	Local via LED light and software message
Maximum number of signal modules	Undervoltage, overvoltage, short-circuit and overload of individual connector and the entire module, 16 digital inputs modules 8 M8 + 16 digital outputs modules 8 M8 (or 8 modules with 16 Inputs + 8 modules with 16 Outputs) ** + 4 analogue inputs modules + 4 analogue outputs modules + 4 analogue input modules for temperature measurement
Ambient temperature	°C -10 to + 50 °F 14 to 122
Versions	digital input, digital output, analogue input, analogue output
Degree of protection	IP65 (with connectors connected or plugged if not used) IP40 for 16-position I/O modules

- \* Minimum voltage 10.8V required at solenoid pilots. Check the minimum voltage at the power supply output using the calculations shown on general catalogue  
 \*\* For 16-IN/OUT modules, powered via the fieldbus. Check that the total current of simultaneously connected Inputs and Outputs is not greater than 3.5 A.  
 \*\*\* IMPORTANT! Voltage greater than 32VDC will damage the system irreparably.

Code	Description	Weight [g]	Code	Description	Weight [g]	Code	Description	Weight [g]
02282S01	Modulo 8 Input digitali M8 EB 80	240	02282S04	Modulo 4 Input analogici M8 EB 80	223	02282S07	EB 80 module with 16 digital terminal block outputs	240
02282S02	Modulo 8 Output digitali M8 EB 80	240	02282S05	Modulo 4 Output analogici M8 EB 80	223	02282S08	EB 80 module with 4 M8 analogue inputs for temperature measurement	223
02282S03	Modulo 6 Output digitali M8 + alimentazione elettrica EB 80	248	02282S06	EB 80 module with 16 digital terminal block inputs	240			

## ACCESSORIES

### M8 PLUG

Code	Description
0240009039	Plug for M8 connector

### M8 CONNECTOR FOR DIGITAL INPUTS / OUTPUTS

Code	Description
0240009010	M8 3-pin straight connector

### M8 CONNECTOR WITH CABLE FOR DIGITAL INPUTS/OUTPUTS

Code	Description
0240009009	M8-M8 3-pin straight connector with cable L = 3 m

### M8 MALE CONNECTOR FOR ANALOGUE INPUTS/OUTPUTS

Code	Description
0240010300	M8 4-pin male connector

### M8 CONNECTOR FOR POWER SUPPLY

Code	Description
0240009060	M8 4-pin female connector for power supply, cable L = 3 m
0240009037	M8 4-pin female connector for power supply, cable L = 5 m
0240009058	M8 4-pin female connector for power supply, cable L = 10 m
0240009059	M8 4-pin female connector for power supply, cable L = 15 m
0240009P60 *	M8 4-pin female connector for power supply, H-FLEX CL6, cable L = 3 m
0240009P37 *	M8 4-pin female connector for power supply, H-FLEX CL6, cable L = 5 m
0240009P58 *	M8 4-pin female connector for power supply, H-FLEX CL6, cable L = 10 m
0240009P59 *	M8 4-pin female connector for power supply, H-FLEX CL6, cable L = 15 m

\* Mobile laying cable, class 6 according to IEC 60228

### 90° M8 CONNECTORS WITH SHIELDED CABLE

Code	Description
0240009102	M8 4-pin female, 90° connector with shielded cable L = 2 m
0240009103	M8 4-pin female, 90° connector with shielded cable L = 5 m

### NOTE

### M8 4-POLE MALE CONNECTOR

Code	Description
0240010105	M8 4-pin connector shielded cable L = 5 m

### M8 3-POLE MALE – M12 5-POLE FEMALE CONNECTOR WITH CABLE FOR DIGITAL INPUTS/OUTPUTS

Code	Description
0240009045	M8 3-pole male straight - M12 5-pole female connector with cable L= 0.2 m

### M8 4-POLE MALE – M12 8-POLE FEMALE CONNECTOR WITH CABLE FOR REGTRONIC CONNECTION

Code	Description
0240009046	M8 4-pole male straight - M12 8-pole female connector with cable L= 1 m

### M8 CONNECTOR WITH SHIELDED CABLE FOR ANALOGUE INPUTS/OUTPUTS

Code	Description
0240005005	M8-M, M8-F 4-pole straight connector ith shielded cable L = 1 m
0240005006	M8-M, M8-F 4-pole straight connector ith shielded cable L = 3 m
0240005003	M8-M, M8-F 4-pole straight connector ith shielded cable L = 5 m
0240005008	M8-M, M8-F 4-pole straight connector ith shielded cable L = 10 m

### ADDITIONAL FIXING BRACKET TO OMEGA BAR

Code	Description
02282R4001	Additional fixing bar accessory to EB 80 omega bar

N.B.: to be used to improve the fixing to Omega bars of islands with more than 40 valves. The bracket must be positioned every 20-25 valves.

## SPARE PARTS

### EB 80 BUS/SIGNAL INTERFACE OR SEAL

Code	Description
02282R1005	EB 80 BUS/Signal interface OR seal

Comes in 10-pc. packs

### EB 80 GASKET BETWEEN BASE AND BUS/SIGNAL COVER

Code	Description
02282R1004	Kit of gaskets between base and BUS/Signal cover

Comes in 10-pc. packs

### IDENTIFICATION PLATE KIT

Code	Description
0226107000	Identification plate kit

Comes in 16-pc. packs

## EB 80 ELECTRICAL CONNECTION - E

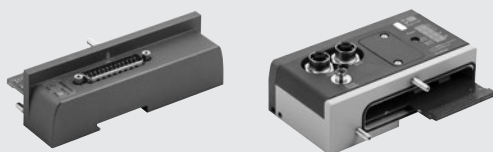

TECHNICAL DATA	
Supply voltage range	V 12 -10% 24 +30%
Minimum operating voltage	V 10.8 *
Maximum operating voltage	V 31.2
Maximum admissible voltage	V 32 ***
Drive (for multi-pole)	PNP or NPN
Solenoid rating	100% ED
Power supply without controlled valves:	
steady rate, with multi-pole connection	W 0.1 for "Electrical connection - E" + 0.25 for each "Base - B"
steady rate, with fieldbus connection	W 4 for "Electrical connection - E" + 0.25 for each "Base - B"
Signal module supply power	See chapter "Signal module - S"
Maximum operating power supply (data useful for the sizing of the power supply unit)	W 3.15 for each solenoid pilot operated simultaneously + input and output
Maximum current admissible with multi-pole connection	A 6 continuous, 9 instantaneous
with fieldbus connection	A 4 continuous, 6 instantaneous for valve supply 4 continuous, 6 instantaneous for bus and signal supply
Protection	Overload and short-circuit protected solenoid pilot Output
Diagnostics	LED signal on valve, LED light on electrical connection. With multi-pole: fault signal OUT activation. With field bus: software message.
Faults signalled	Short-circuited solenoid pilot; Solenoid pilot broken or missing Power supply out of range (under-voltage or over-voltage) With fieldbus only, different configuration, on switching on, compared to that stored; communication control between modules
Ambient temperature	°C -10 to + 50 °F 14 to 122
Versions	Plug connectors, fieldbus with various protocols, additional island
Maximum number of controllable solenoid pilots **	25-pin connector   44-pin connector   Fieldbus   additional island 21   38   128   128
Maximum number of controllable solenoid valves	Ditto as above, depending on the number of solenoid pilots and type of base
Degree of protection	IP65 (with connectors connected or plugged if not used)
Weight	g 180   180   350   320

\* Minimum voltage 10.8V required at solenoid pilots. Check the minimum voltage at the power pack output using the calculations shown on general catalogue.

\*\* If the units are made up of bases exceeding the maximum number of controllable solenoid pilots (by mounting a dummy valve N or a bypass Y in the excess positions), operation is only possible on the islands with a positive signal (PNP), conversely (with an NPN signal), an error message is generated by the diagnostic system.

\*\*\* IMPORTANT! Voltage greater than 32VDC will damage the system irreparably.

Code	Description	Weight [g]	Code	Description	Weight [g]	Code	Description	Weight [g]
02282E025	EB 80 25-pin electrical connection	180	02282E0EN	EB 80 Electrical connection EtherNet/IP	350	02282E0AD	Additional electrical connection EB 80	320
02282E044	EB 80 44-pin electrical connection	180	02282E0EC	EB 80 Electrical connection EtherCAT	350			
			02282E0PN	EB 80 Electrical connection Profinet IO	350			
			02282E0CN	EB 80 Electrical connection CANopen	350			
			02282E0PB	EB 80 Electrical connection Profibus-DP	350			
			02282E0PL	EB 80 Electrical connection Ethernet POWERLINK	350			
			02282E0IO	EB 80 Electrical connection IO-Link	350			

## ACCESSORIES

### MULTI-POLE ELECTRICAL CONNECTION

#### 25-PIN PRE-WIRED PLUG CONNECTOR

Code	Description	Weight [g]
02269A0100	IP65 25-pin 90° connector, UL cable L = 1 m	180
02269A0250	IP65 25-pin 90° connector, UL cable L = 2.5 m	365
02269A0500	IP65 25-pin 90° connector, UL cable L = 5 m	680
02269A1000	IP65 25-pin 90° connector, UL cable L = 10 m	1220
02269A2000	IP65 25-pin 90° connector, UL cable L = 20 m	2350
02269C0100 **	IP65 25-pin 90° connector, UL H-FLEX CL6, cable L = 1 m	180
02269C0250 **	IP65 25-pin 90° connector, UL H-FLEX CL6, cable L = 2.5 m	365
02269C0500 **	IP65 25-pin 90° connector, UL H-FLEX CL6, cable L = 5 m	680
02269C1000 **	IP65 25-pin 90° connector, UL H-FLEX CL6, cable L = 10 m	1220

\*\* Mobile laying cable, class 6 according to IEC 60228

#### 44-PIN PRE-WIRED PLUG CONNECTOR

Code	Description	Weight [g]
02269B0100	IP65 44-pin 90° connector, UL cable L = 1 m	275
02269B0250	IP65 44-pin 90° connector, UL cable L = 2.5 m	630
02269B0500	IP65 44-pin 90° connector, UL cable L = 5 m	1180
02269B1000	IP65 44-pin 90° connector, UL cable L = 10 m	2210
02269B2000	IP65 44-pin 90° connector, UL cable L = 20 m	4340
02269D0100 **	IP65 44-pin 90° connector, UL H-FLEX CL6, cable L = 1 m	275
02269D0250 **	IP65 44-pin 90° connector, UL H-FLEX CL6, cable L = 2.5 m	630
02269D0500 **	IP65 44-pin 90° connector, UL H-FLEX CL6, cable L = 5 m	1180
02269D1000 **	IP65 44-pin 90° connector, UL H-FLEX CL6, cable L = 10 m	2210

\*\* Mobile laying cable, class 6 according to IEC 60228

### EB80 - ELECTRICAL CONNECTION WITH FIELDBUS

#### M12 FEMALE CONNECTOR FOR BUS-IN, A ENCODING

Code	Description
0240009055	M12 5-pin female connector, encoding A

Note: Can be used for Bus CANopen and IO-Link

#### M12 MALE CONNECTOR FOR BUS-IN, A ENCODING

Code	Description
0240009038	M12 5-pin male connector, encoding A

Note: Can be used for Bus CANopen

#### M12 FEMALE CONNECTOR FOR BUS-IN, B ENCODING

Code	Description
0240009036	M12 5-pin female connector, encoding B

Note: Can be used for Profibus-DP

#### M12 MALE CONNECTOR FOR BUS-IN, B ENCODING

Code	Description
0240009035	M12 5-pin male connector, encoding B

Note: Can be used for Profibus-DP

#### M12 BUS CONNECTOR, D ENCODING

Code	Description
0240005051	M12 4-pin BUS connector, D-coded

Note: Can be used for BUS units in the EtherNet family (Profinet IO, EtherCAT, EtherNet/IP, Ethernet POWERLINK)

#### STRAIGHT CONNECTOR FOR M12-M12 BUS, D-CODED

Code	Description
0240005103	Straight connector for M12-M12 4-pin BUS, D-coded, with 3 m cable
0240005105	Straight connector for M12-M12 4-pin BUS, D-coded, with 5 m cable
0240005110	Straight connector for M12-M12 4-pin BUS, D-coded, with 10 m cable

Note: Can be used for BUS units in the EtherNet family (Profinet IO, EtherCAT, EtherNet/IP, Ethernet POWERLINK)

#### STRAIGHT CONNECTOR FOR M12 BUS, D-CODED

Code	Description
0240005093	Straight connector for M12 4-pin BUS, D-coded, with 3 m cable
0240005095	Straight connector for M12 4-pin BUS, D-coded, with 5 m cable
0240005100	Straight connector for M12 4-pin BUS, D-coded, with 10 m cable

Note: Can be used for BUS units in the EtherNet family (Profinet IO, EtherCAT, EtherNet/IP, Ethernet POWERLINK)

#### STRAIGHT CONNECTOR FOR M12, A-CODED

Code	Description
W0970513001	5-PIN M12X1 straight connector

Note: Can be used for IO-Link

#### STRAIGHT CONNECTOR WITH WIRE FOR M12, A-CODED

Code	Description
W0970513002	5-PIN M12X1 straight connector with wire L = 5 m

Note: Can be used for IO-Link

#### 90° CONNECTOR FOR M12, A-CODED

Code	Description
W0970513003	M12X1 5-PIN 90° connector

Note: Can be used for IO-Link

#### 90° CONNECTOR WITH WIRE FOR M12, A-CODED

Code	Description
W0970513004	M12X1 5-PIN 90° connector with wire L = 5 m

Note: Can be used for IO-Link

#### CABLE FOR BUS

Code	Description
0240005220*	Cable for BUS 20 m
0240005250	Cable for BUS CANopen BUS 20 m

\* Can be used for BUS units in the EtherNet family (Profinet IO, EtherCAT, EtherNet/IP, Ethernet POWERLINK)

### RJ45 CONNECTOR

Code	Description
0240005050	RJ45 connector with 4 contacts according to IEC 60 603-7

### M8 CONNECTOR FOR POWER SUPPLY

Code	Description
0240009060	M8 4-pin female connector for power supply, cable L = 3 m
0240009037	M8 4-pin female connector for power supply, cable L = 5 m
0240009058	M8 4-pin female connector for power supply, cable L = 10 m
0240009059	M8 4-pin female connector for power supply, cable L = 15 m
0240009P60 *	M8 4-pin female connector for power supply, H-FLEX CL6, cable L = 3 m
0240009P37 *	M8 4-pin female connector for power supply, H-FLEX CL6, cable L = 5 m
0240009P58 *	M8 4-pin female connector for power supply, H-FLEX CL6, cable L = 10 m
0240009P59 *	M8 4-pin female connector for power supply, H-FLEX CL6, cable L = 15 m

\* Mobile laying cable, class 6 according to IEC 60228

### M8-M12 PLUG

Code	Description
0240009039	Plug for M8 connector
0240009040	Plug for M12 connector

### EB80 - ADDITIONAL ELECTRICAL CONNECTION

#### M8 CONNECTOR FOR POWER SUPPLY

Code	Description
0240009060	M8 4-pin female connector for power supply, cable L = 3 m
0240009037	M8 4-pin female connector for power supply, cable L = 5 m
0240009058	M8 4-pin female connector for power supply, cable L = 10 m
0240009059	M8 4-pin female connector for power supply, cable L = 15 m
0240009P60 *	M8 4-pin female connector for power supply, H-FLEX CL6, cable L = 3 m
0240009P37 *	M8 4-pin female connector for power supply, H-FLEX CL6, cable L = 5 m
0240009P58 *	M8 4-pin female connector for power supply, H-FLEX CL6, cable L = 10 m
0240009P59 *	M8 4-pin female connector for power supply, H-FLEX CL6, cable L = 15 m

\* Mobile laying cable, class 6 according to IEC 60228

#### M8 CONNECTOR WITH CABLE FOR CONNECTION BETWEEN EB 80 ISLANDS

Code	Description	Weight [g]
0240010201	M8-M8 4-pin male shielded cable L = 1 m	45
0240010205	M8-M8 4-pin male shielded cable L = 5 m	185
0240010210	M8-M8 4-pin male shielded cable L = 10 m	330
0240010215	M8-M8 4-pin male shielded cable L = 15 m	475
0240010220	M8-M8 4-pin male shielded cable L = 20 m	620
0240010405 *	M8-M8 4-pin male shielded cable H-FLEX CL6, L = 5 m	185
0240010410 *	M8-M8 4-pin male shielded cable H-FLEX CL6, L = 10 m	330
0240010415 *	M8-M8 4-pin male shielded cable H-FLEX CL6, L = 15 m	475
0240010420 *	M8-M8 4-pin male shielded cable H-FLEX CL6, L = 20 m	620

\* Mobile laying cable, class 6 according to IEC 60228

N.B.: For correct operation of the entire EB 80 system, use M8-M8 pre-wired, twisted and shielded cables only.

### M8-M12 PLUG

Code	Description
0240009039	Plug for M8 connector

## SPARE PARTS

### EB 80 ELECTRICAL CONNECTION INTERFACE OR-SEAL

Code	Description
02282R1003	EB 80 electrical connection interface or-seal

Comes in 10-pc. packs

### GASKET BETWEEN EB 80 BASE AND COVER BUS/SIGNALS

Code	Description
02282R1004	Kit of gaskets between EB 80 base and cover bus/signals

Comes in 10-pc. packs

### EB 80 BUS/SIGNAL INTERFACE OR-SEAL

Code	Description
02282R1005	EB 80 BUS/Signal interface OR-seal

Comes in 10-pc. packs



## EB 80 COMPRESSED-AIR SUPPLY - P

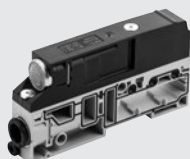

TECHNICAL DATA					
Operating pressure					
Non-servo versions and solenoid pilot servo pressure					
	bar	5/2 and 5/3		2/2 and 3/2	
	MPa	3 to 8		min. (see graph on general catalogue) / max. 8	
	psi	0.3 to 0.8		min. (see graph on general catalogue) / max. 0.8	
	bar	43 to 116		min. (see graph on general catalogue) / max. 116	
Assisted valves				Vacuum to 10	
	MPa			Vacuum to 1	
	psi			Vacuum to 145	
Ambient temperature				-10 to +50	
	°C			14 to 122	
	°F				
Flow rate at 6.3 bar ΔP 1 bar					
Feeding (port 1)		Ø 8 (5/16")	Ø 10	Ø 12	Ø 1/2"
	NI/min	1800	2800	3500	3500
Exhaust with fitting (ports 3 and 5)					
	NI/min	2000	3200	4400	4400
Separate exhausts Ø 8 (N.B.: Pmax 8 bar)					
	NI/min	1800 x 2	-	-	-
Flow rate at 6.3 bar free exhaust					
Exhaust with fitting (ports 3 and 5)					
	NI/min	2700	3900	6100	6100
Silenced exhaust				3600	
	NI/min			6000	
Exhaust with fitting Ø12 and silencer W0970530086					
	NI/min				
Separate exhausts Ø 8 (N.B.: Pmax 8 bar)					
	NI/min	2700 x 2	-	-	-
Fluid		Unlubricated air			
Versions		Silenced relief or conveyed relief, fittings for pipes Ø 8, 10, 12, 1/2"			
Degree of protection		IP65			
Weight		g	140	130	125
				125	125

### KEY TO CODES

02282 FAMILY	P SUBSYSTEM	3 PORT PIPE 1	1 PILOT SERVO-ASSISTED	Z UPPER PART	3 PORTS 3 AND 5 CONNECTION	0 SPECIALTY
02282 EB 80	P Compressed air supply	1 Pipe Ø 8 (5/16") 2 Pipe Ø 10 3 Pipe Ø 12 5 Pipe Ø 1/2"	1 Non-servo-assisted X Servo-assisted	Z The upper part is present	0 Silencer ▲ 1 Pipe Ø 8 (5/16") ▲ 2 Pipe Ø 10 ▲ 3 Pipe Ø 12 ▲ 5 Pipe Ø 1/2" 6 2 pipes Ø 8 (5/16") (one for port 3, one for port 5) 9 Without connection	0 Standard
		9 Module for electric version only	1 Non-servo-assisted			

▲ For ports 3 and 5 use the same pipe Ø of port 1.

### COMPRESSED AIR SUPPLY - SILENCED RELIEF

Pipe fitting	Code	Weight [g]
<b>Servo-assisted</b>		
Ø 8 (5/16")	02282P1XZ00	140
Ø 10	02282P2XZ00	130
Ø 12	02282P3XZ00	125
Ø 1/2"	02282P5XZ00	125
<b>Non-servo-assisted</b>		
Ø 8 (5/16")	02282P11Z00	140
Ø 10	02282P21Z00	130
Ø 12	02282P31Z00	125
Ø 1/2"	02282P51Z00	125

### COMPRESSED AIR SUPPLY - SEPARATE RELIEFS

N.B.: Maximum pressure in the ports 3 and 5: 8 bar

Pipe fitting	Code	Weight [g]
<b>Servo-assisted</b>		
Ø 8 (5/16")	02282P1XZ60	155
Ø 10	02282P2XZ60	145
Ø 12	02282P3XZ60	140
Ø 1/2"	02282P5XZ60	140
<b>Non-servo-assisted</b>		
Ø 8 (5/16")	02282P11Z60	155
Ø 10	02282P21Z60	145
Ø 12	02282P31Z60	140
Ø 1/2"	02282P51Z60	140

### COMPRESSED AIR SUPPLY - CONVEYED RELIEF

Pipe fitting	Code	Weight [g]
<b>Servo-assisted</b>		
Ø 8 (5/16")	02282P1XZ10	140
Ø 10	02282P2XZ20	130
Ø 12	02282P3XZ30	125
Ø 1/2"	02282P5XZ50	125
<b>Non-servo-assisted</b>		
Ø 8 (5/16")	02282P11Z10	140
Ø 10	02282P21Z20	130
Ø 12	02282P31Z30	125
Ø 1/2"	02282P51Z50	125

### MODULE FOR ELECTRIC VERSION ONLY

Code	Description	Weight [g]
02282P91Z90	Module for electric version only	120

N.B.: Version used to make up an EB 80 island without pneumatic part, but only with "S" signal modules and fieldbus or additional electrical connection "E". Bases and valves cannot be added.

## ACCESSORIES

### SILENCER FOR FITTING

Code	Description	Weight [g]
W0970530084	Silencer for fitting, Ø 8	15
W0970530086	Silencer for fitting, Ø 12	24

## SPARE PARTS

### CARTRIDGE

Code	Description	Ø
02282R2110	EB 80 silencer cartridge kit	silencer
02282R2113	EB 80 Ø 8 power supply round cartridge kit	8 (5/16")
02282R2114	EB 80 Ø 10 power supply round cartridge kit	10
02282R2115	EB 80 Ø 12 power supply round cartridge kit	12
02282R2118	EB 80 Ø 1/2 power supply round cartridge kit	1/2"

Comes in 10-pc. packs

### BASE INTERFACE GASKET

Code	Description
02282R1000	EB 80 base interface gasket kit

Comes in 10-pc. packs

### LOWER / UPPER BODY GASKET

Code	Description
02282R1001	EB 80 lower/upper body gasket kit

Comes in 10-pc. packs

## EB 80 BASES FOR VALVES - B

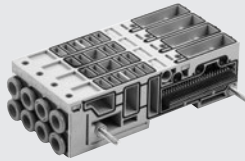

TECHNICAL DATA	
Ambient temperature	°C -10 to + 50 °F 14 to 122
Fluid	Unlubricated air
Versions	3-position base for controlling 3 solenoid pilots; 3 positions for 6 solenoid pilots; 4 positions for 4 solenoid pilots; 4 positions for 8 solenoid pilots. Pipe fittings Ø 4 (5/32"), 6, 8 (5/16"), 1/4" Ducts 1, 3, 5 and X full flow
Degree of protection	3-position base with 1 sectioned duct; 1, 3 a 5 sectioned; 3 and 5 sectioned (after the first position) IP65

### KEY TO CODES

02282 FAMILY	B SUBSYSTEM	3 NUMBER OF POSITIONS	0 PORTS IN THE BASE	6 NUMBER OF SOLENOID PILOT CONTROLS	8 1 <sup>st</sup> position (from left)	8 FITTINGS 2 <sup>nd</sup> position	8 3 <sup>rd</sup> position	0 FITTINGS 4 <sup>th</sup> position
02282 EB 80	B Base for valve	3 3 positions 4 4 positions	0 Full-flow ports ▲ 1 Port 1 sectioned ▲ 2 Ports 1, 3 and 5 sectioned ▲ 3 Ports 3 and 5 sectioned	▲ 3 3 controls ■ 4 4 controls ▲ 6 6 controls ■ 8 8 controls	1 Without cartridges 2 Pipe fitting Ø 1/4" 4 Pipe fitting Ø 4 (5/32") 6 Pipe fitting Ø 6 8 Pipe fitting Ø 8 (5/16")			▲ 0 (for 3-position base) ■ 1 Without cartridges ■ 2 Pipe fitting Ø 1/4" ■ 4 Pipe fitting Ø 4 (5/32") ■ 6 Pipe fitting Ø 6 ■ 8 Pipe fitting Ø 8 (5/16")

- ▲ For 3-position base only.
- For 4-position base only.

### 3-POSITION BASE FOR VALVES

Pipe fitting	Code	Weight [g]
3 CONTROLS		
<b>Full-flow ports</b>		
without cartridges	02282B3031110	148
Ø 4 (5/32")	02282B3034440	210
Ø 6	02282B3036660	200
Ø 8 (5/16")	02282B3038880	183
Ø 1/4"	02282B3032220	200
<b>Port 1 sectioned after the first position</b>		
without cartridges	02282B3131110	148
Ø 4 (5/32")	02282B3134440	210
Ø 6	02282B3136660	200
Ø 8 (5/16")	02282B3138880	183
Ø 1/4"	02282B3132220	200

### 4-POSITION BASE FOR VALVES

Pipe fitting	Code	Weight [g]
4 CONTROLS		
<b>Full-flow ports</b>		
without cartridges	02282B4041111	196
Ø 4 (5/32")	02282B4044444	276
Ø 6	02282B4046666	256
Ø 8 (5/16")	02282B4048888	244
Ø 1/4"	02282B4042222	256

## ACCESSORIES

### SILENCER FOR FITTING, Ø 8

Code	Description	Weight [g]
W0970530084	Silencer for fitting, Ø 8	15

### ADDITIONAL FIXING BRACKET TO OMEGA BAR

Code	Description
02282R4001	Additional fixing bar accessory to EB 80 omega bar

N.B.: to be used to improve the fixing to Omega bars of islands with more than 40 valves. The bracket must be positioned every 20-25 valves.

## SPARE PARTS

### CARTRIDGE

Code	Description	Ø
02282R2001	EB 80 Ø 4 base square cartridge kit	4 (5/32")
02282R2002	EB 80 Ø 6 base square cartridge kit	6
02282R2003	EB 80 Ø 8 base square cartridge kit	8 (5/16")
02282R2006	EB 80 Ø 1/4 base square cartridge kit	1/4"

Comes in 10-pc. packs

### BASE INTERFACE GASKET

Code	Description
02282R1000	EB 80 base interface gasket kit

Comes in 10-pc. packs

### BASE-VALVE GASKET

Code	Description
02282R1002	EB 80 base-valve gasket kit

Comes in 10-pc. packs

## EB 80 VALVES



TECHNICAL DATA								
Operating pressure			<b>5/2 and 5/3</b>		<b>2/2 and 3/2</b>			
Non-assisted valves	bar		3 to 8		3.5 to 8			
	MPa		0.3 to 0.8		0.35 to 0.8			
	psi		43 to 116		51 to 116			
Assisted valves	bar		Vacuum to 10					
	MPa		Vacuum to 1					
	psi		Vacuum to 145					
Servo pressure	bar		3 to 8		min. (see graph on general catalogue) / max. 8			
	MPa		0.3 to 0.8		min. (see graph on general catalogue) / max. 0.8			
	psi		43 to 116		min. (see graph on general catalogue) / max. 116			
Ambient temperature	°C		-10 to 50 (at 8 bar)					
	°F		14 to 122 (at 8 bar)					
Flow rate at 6.3 bar ΔP 1 bar			<b>Ø 4 (5/32")</b>	<b>Ø 6</b>	<b>Ø 8 (5/16")</b>	<b>Ø 1/4"</b>	<b>Ø 10 **</b>	<b>Ø 3/8" **</b>
	valve 2/2	Nl/min	350	430	500	430	-	-
	valve 3/2	Nl/min	350	600	700	600	1250	1250
	valve 5/2	Nl/min	350	650	800	650	1250 - 1400	1250 - 1400
	valve 5/3	Nl/min	350	460	500	460	1000 - 1250	1000 - 1250
	valve V3V (R)	Nl/min	-	-	-	-	1000	1000
Actuation response time (TRA) / reset response time (TRR) at 6 bar								
	TRA/TRR valves 2/2 and 3/2	ms	14 / 28					
	TRA/TRR valves 5/2 monostable and shut-off valve	ms	12 / 45					
	TRA/TRR valve 5/2 bistable	ms	12 / 14					
	TRA/TRR valve 5/3	ms	15 / 45					
	TRA/TRR valve 3/2 high flow	ms	13 / 36					
Fluid			Unlubricated air					
Air quality required			ISO 8573-1 class 4-7-3					
Supply voltage range	V		12 -10% 24 +30%					
Minimum operating voltage	V		10.8 *					
Maximum operating voltage	V		31.2					
Maximum admissible voltage	V		32 ***					
Power for each valve	W		3 for a few milliseconds. Holding 0.3					
Drive			PNP or NPN					
Solenoid rating			100% ED					
Versions			Manual monostable or bistable control. Various compressed air diagrams					
Degree of protection			IP65					

\* Minimum voltage 10.8V required at solenoid pilots. Check the minimum voltage at the power pack output using the calculations shown on general catalogue

\*\* Using high-flow valves or connected valves.

\*\*\* IMPORTANT! Voltage greater than 32VDC will damage the system irreparably.

### EB 80 VALVE

N.B.: The valves Z, I, W, L, K, O can be mounted only on bases having 6 or 8 controls.

Symbol	Type	Code	Manual control	Weight [g]	Symbol	Type	Code	Manual control	Weight [g]
<b>Z</b>	2 valves 2/2 NC	708203Z0	monostable	82	<b>V</b>	monostable 5/2	708203V0	monostable	69
			bistable	82				bistable	69
<b>I</b>	2 valves 3/2 NC	708203I0	monostable	82	<b>K</b>	bistable 5/2	708203K0	monostable	81
			valid as 5/3 OC	bistable				82	bistable
<b>W</b>	2 valves 3/2 NO	708203W0	monostable	82	<b>O</b>	5/3 CC	708203O0	monostable	82
			valid as 5/3 PC	bistable				82	bistable
<b>L</b>	3/2 NC + 3/2 NO	708203L0	monostable	82					
			bistable	82					

### EB 80 HIGH-FLOW VALVE

Symbol	Type	Code	Manual control	Weight [g]
<b>G</b>	3/2 NC high flow	708203G0	monostable	69
		708203G1	bistable	69
<b>J</b>	3/2 NO high flow	708203J0	monostable	69
		708203J1	bistable	69

### EB 80 SHUT-OFF VALVE (V3V)

Symbol	Type	Code	Manual control	Weight [g]
<b>R</b>	Shut-off valve	708203R0	monostable	69
		708203R1	bistable	69

## ACCESSORIES

#### Y-FITTING

Code	Description	Release bushing color
02282R2Y04	Y-fitting for EB 80 Ø 8 (5/16") - Ø 10	Orange
02282R2Y14	Y-fitting for EB 80 Ø 8 (5/16") - Ø 10	Black
02282R2Y07	Y-fitting for EB 80 Ø 8 (5/16") - Ø 3/8"	Orange
02282R2Y17	Y-fitting for EB 80 Ø 8 (5/16") - Ø 3/8"	Black

#### NOTE

### DUMMY VALVE (PLUG)

Symbol	Description	Code	Weight [g]
<b>N</b>	Dummy valve	708203N0	47

### BYPASS

Symbol	Description	Code	Weight [g]
<b>Y</b>	Bypass Ø 8	708203Y8	50

**N.B.:** Maximum pressure in the ports 2 and 4: 8 bar  
Connects port 3 of the base to port 2 and port 5 to port 4.  
The fitting present is connected to port 1.

## SPARE PARTS

#### BASE FIXING SCREW

Code	Description
02282R3000	Kit of screws for fixing the EB 80 base

Comes in 10-pc. packs

#### IDENTIFICATION PLATE KIT

Code	Description
0226107000	Identification plate kit

Comes in 16-pc. packs

## EB 80 INTERMEDIATE SUPPORT - M

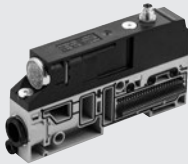

TECHNICAL DATA		Vacuum to 10 bar / Vacuum to 1 MPa / Vacuum to 145 psi			
Operating pressure		-10 to +50 °C / 14 to 122 °F			
Ambient temperature					
Flow rate at 6.3 bar ΔP 1 bar		Ø 8 (5/16")	Ø 10	Ø 12	Ø 1/2"
Feeding (port 1)	Nl/min	1800	2800	3500	3500
Exhaust with fitting (ports 3 and 5)	Nl/min	2000	3200	4400	4400
Separate exhausts Ø 8	Nl/min	1800 x 2	-	-	-
Flow rate at 6.3 bar free exhaust					
Exhaust with fitting (ports 3 and 5)	Nl/min	2700	3900	6100	6100
Silenced exhaust	Nl/min		3600		
Exhaust with fitting Ø 12 and silencer W0970530086	Nl/min		6000		
Separate exhausts Ø 8 (N.B.: Pmax 8 bar)	Nl/min	2700 x 2	-	-	-
Fluid		Unlubricated air			
Additional electrical power supply		M8 4-pin connector *			
Voltage range	V	12 to 31.2			
Maximum number of solenoid pilots that can be actuated simultaneously from the additional electrical connection:		With 100% simultaneity: 48 / With 60% simultaneity: 80			
at 24VDC		With 100% simultaneity: 32 / With 60% simultaneity: 64			
at 12VDC		Pipe fittings Ø 8, 10, 12, 1/2"; Silenced relief, conveyed relief, ports 3 and 5 separate			
Versions		Full-flow ports in the base, 1 closed, 1, 3 and 5 closed, 3 and 5 closed, 1, 3, 5 and X closed			
Degree of protection		With or without additional electrical power supply IP65 (with connectors connected or plugged if not used)			

**IMPORTANT! Voltage greater than 32VDC will damage the system irreparably.**

\* If electric power is not supplied: the red power LED light comes on and the LEDs at the base keep flashing (voltage out of range); in the version with multi-pin electrical connection, the "OUT" fault signal is triggered; in the version with fieldbus, a software message is sent.

### KEY TO CODES

02282 FAMILY	M SUBSYSTEM	3 PORT FITTING 1	0 PORTS IN THE BASE	0 ADDITIONAL ELECTRICAL POWER SUPPLY	Z UPPER PART	3 PORTS 3 AND 5 FITTING	0 ELECTRICAL CONNECTOR
02282 EB 80	M Intermediate	1 Pipe fitting Ø 8 (5/16") 2 Pipe fitting Ø 10 3 Pipe fitting Ø 12 5 Pipe fitting Ø 1/2"	0 Full-flow ports 1 Port 1 closed 2 Ports 1, 3 and 5 closed 3 Ports 3 and 5 closed 4 Ports 1, 3, 5 and X closed	■ 0 Without ● 1 With	Z The upper part is present	0 Silencer ▲ 1 Pipe fitting Ø 8 (5/16") ▲ 2 Pipe fitting Ø 10 ▲ 3 Pipe fitting Ø 12 ▲ 5 Pipe fitting Ø 1/2" 6 2 pipes fitting Ø 8 (5/16") (one for port 3, one for port 5)	■ 0 Without ● 1 With

▲ For ports 3/5, use the same Ø pipe as port 1 ■ Same number for both positions ● Same number for both positions.

### INTERMEDIATE MODULE - SILENCED RELIEF

Pipe fitting	Code	Weight [g]
	Additional electric power supply WITHOUT	WITH
<b>Full-flow ports</b>		
Ø 8 (5/16")	02282M100Z00	02282M101Z01 168
Ø 10	02282M200Z00	02282M201Z01 164
Ø 12	02282M300Z00	02282M301Z01 160
Ø 1/2"	02282M500Z00	02282M501Z01 160
<b>Port 1 closed</b>		
Ø 8 (5/16")	02282M110Z00	02282M111Z01 168
Ø 10	02282M210Z00	02282M211Z01 164
Ø 12	02282M310Z00	02282M311Z01 160
Ø 1/2"	02282M510Z00	02282M511Z01 160
<b>Ports 1, 3 and 5 closed</b>		
Ø 8 (5/16")	02282M120Z00	02282M121Z01 168
Ø 10	02282M220Z00	02282M221Z01 164
Ø 12	02282M320Z00	02282M321Z01 160
Ø 1/2"	02282M520Z00	02282M521Z01 160
<b>Ports 3 and 5 closed</b>		
Ø 8 (5/16")	02282M130Z00	02282M131Z01 168
Ø 10	02282M230Z00	02282M231Z01 164
Ø 12	02282M330Z00	02282M331Z01 160
Ø 1/2"	02282M530Z00	02282M531Z01 160
<b>Ports 1, 3, 5 and X closed</b>		
Ø 8 (5/16")	02282M140Z00	02282M141Z01 168
Ø 10	02282M240Z00	02282M241Z01 164
Ø 12	02282M340Z00	02282M341Z01 160
Ø 1/2"	02282M540Z00	02282M541Z01 160

### INTERMEDIATE MODULE - CONVEYED RELIEF

Pipe fitting	Code	Weight [g]
	Additional electric power supply WITHOUT	WITH
<b>Full-flow ports</b>		
Ø 8 (5/16")	02282M100Z10	02282M101Z11 168
Ø 10	02282M200Z10	02282M201Z11 164
Ø 12	02282M300Z10	02282M301Z11 160
Ø 1/2"	02282M500Z10	02282M501Z11 160
<b>Port 1 closed</b>		
Ø 8 (5/16")	02282M110Z10	02282M111Z11 168
Ø 10	02282M210Z10	02282M211Z11 164
Ø 12	02282M310Z10	02282M311Z11 160
Ø 1/2"	02282M510Z10	02282M511Z11 160
<b>Ports 1, 3 and 5 closed</b>		
Ø 8 (5/16")	02282M120Z10	02282M121Z11 168
Ø 10	02282M220Z10	02282M221Z11 164
Ø 12	02282M320Z10	02282M321Z11 160
Ø 1/2"	02282M520Z10	02282M521Z11 160
<b>Ports 3 and 5 closed</b>		
Ø 8 (5/16")	02282M130Z10	02282M131Z11 168
Ø 10	02282M230Z10	02282M231Z11 164
Ø 12	02282M330Z10	02282M331Z11 160
Ø 1/2"	02282M530Z10	02282M531Z11 160
<b>Ports 1, 3, 5 and X closed</b>		
Ø 8 (5/16")	02282M140Z10	02282M141Z11 168
Ø 10	02282M240Z10	02282M241Z11 164
Ø 12	02282M340Z10	02282M341Z11 160
Ø 1/2"	02282M540Z10	02282M541Z11 160

### INTERMEDIATE MODULE - SEPARATE RELIEF

N.B.: Maximum pressure in the ports 3 and 5: 8 bar

Pipe fitting	Code	Weight [g]
	Additional electric power supply WITHOUT	WITH
<b>Full-flow ports</b>		
Ø 8 (5/16")	02282M100Z60	02282M101Z61 179
Ø 10	02282M200Z60	02282M201Z61 175
Ø 12	02282M300Z60	02282M301Z61 171
Ø 1/2"	02282M500Z60	02282M501Z61 171
<b>Port 1 closed</b>		
Ø 8 (5/16")	02282M110Z60	02282M111Z61 179
Ø 10	02282M210Z60	02282M211Z61 175
Ø 12	02282M310Z60	02282M311Z61 171
Ø 1/2"	02282M510Z60	02282M511Z61 171
<b>Ports 1, 3 and 5 closed</b>		
Ø 8 (5/16")	02282M120Z60	02282M121Z61 179
Ø 10	02282M220Z60	02282M221Z61 175
Ø 12	02282M320Z60	02282M321Z61 171
Ø 1/2"	02282M520Z60	02282M521Z61 171
<b>Ports 3 and 5 closed</b>		
Ø 8 (5/16")	02282M130Z60	02282M131Z61 179
Ø 10	02282M230Z60	02282M231Z61 175
Ø 12	02282M330Z60	02282M331Z61 171
Ø 1/2"	02282M530Z60	02282M531Z61 171
<b>Ports 1, 3, 5 and X closed</b>		
Ø 8 (5/16")	02282M140Z60	02282M141Z61 179
Ø 10	02282M240Z60	02282M241Z61 175
Ø 12	02282M340Z60	02282M341Z61 171
Ø 1/2"	02282M540Z60	02282M541Z61 171

## ACCESSORIES

### M8 CONNECTOR FOR POWER SUPPLY

Code	Description
0240009060	M8 4-pin female connector for power supply, cable L = 3 m
0240009037	M8 4-pin female connector for power supply, cable L = 5 m
0240009058	M8 4-pin female connector for power supply, cable L = 10 m
0240009059	M8 4-pin female connector for power supply, cable L = 15 m
0240009P60 *	M8 4-pin female connector for power supply, H-FLEX CL6, cable L = 3 m
0240009P37 *	M8 4-pin female connector for power supply, H-FLEX CL6, cable L = 5 m
0240009P58 *	M8 4-pin female connector for power supply, H-FLEX CL6, cable L = 10 m
0240009P59 *	M8 4-pin female connector for power supply, H-FLEX CL6, cable L = 15 m

\* Mobile laying cable, class 6 according to IEC 60228

### M8 90° CONNECTOR FOR POWER SUPPLY

Code	Description
0240009103	M8 4-pin connector - female, 90° angle L = 5 m

### SILENCER FOR FITTING

Code	Description	Weight [g]
W0970530084	Silencer for fitting, Ø 8	15
W0970530086	Silencer for fitting, Ø 12	24

## SPARE PARTS

### CARTRIDGE

Code	Description	Ø
02282R2110	EB 80 silencer cartridge kit	silencer
02282R2113	EB 80 Ø 8 power supply round cartridge kit	8 (5/16")
02282R2114	EB 80 Ø 10 power supply round cartridge kit	10
02282R2115	EB 80 Ø 12 power supply round cartridge kit	12
02282R2118	EB 80 Ø 1/2 power supply round cartridge kit	1/2"

Comes in 10-pc. packs

### BASE INTERFACE GASKET

Code	Description
02282R1000	EB 80 base interface gasket kit

Comes in 10-pc. packs

### LOWER / UPPER BODY GASKET

Code	Description
02282R1001	EB 80 lower/upper body gasket kit

Comes in 10-pc. packs

## EB 80 CLOSED END-PLATE - C



### TECHNICAL DATA

Ambient temperature	°C	-10 to + 50
	°F	14 to 122
Versions	For islands with multi-pole connection. For island with fieldbus. For connection to additional islands.	
Degree of protection	IP65 (with connectors connected or plugged if not used)	
Notes	All valve units (including multi-pole versions) require earthing protection. Use M4 thread on the end plate with braided cable code 02282R6000 provided or, when fixing the unit onto a DIN bar, connect the bar to earthing.	

### CLOSED END PLATE FOR ISLANDS WITH MULTI-POLE CONNECTOR

Code	Description	Weight [g]
02282C1	Closed end-plate for islands with multi-pole connector	92

### CLOSED END-PLATE FOR ISLANDS WITH FIELDBUS

Code	Description	Weight [g]
02282C2	Closed end-plate for islands with fieldbus	148

Note: also usable for islands with multi-pole connector

### CLOSED END PLATE FOR ELECTRICAL CONNECTION TO ADDITIONAL ISLANDS

Code	Description	Weight [g]
02282C3	Closed end-plate for electrical connection to additional islands	148

Note: if you do not connect additional island you must mount the M8 end connector

## ACCESSORIES

### M8 CONNECTOR WITH CABLE FOR CONNECTION BETWEEN EB 80 ISLANDS

Code	Description	Weight [g]
0240010201	M8-M8 4-pin male shielded cable L = 1 m	45
0240010205	M8-M8 4-pin male shielded cable L = 5 m	185
0240010210	M8-M8 4-pin male shielded cable L = 10 m	330
0240010215	M8-M8 4-pin male shielded cable L = 15 m	475
0240010220	M8-M8 4-pin male shielded cable L = 20 m	620
0240010405 *	M8-M8 4-pin male shielded cable H-FLEX CL6, L = 5 m	185
0240010410 *	M8-M8 4-pin male shielded cable H-FLEX CL6, L = 10 m	330
0240010415 *	M8-M8 4-pin male shielded cable H-FLEX CL6, L = 15 m	475
0240010420 *	M8-M8 4-pin male shielded cable H-FLEX CL6, L = 20 m	620

\* Mobile laying cable, class 6 according to IEC 60228

N.B.: For correct operation of the entire EB 80 system, use M8-M8 pre-wired, twisted and shielded cables only.

### M8 END CONNECTOR FOR EB 80 VALVES

Code	Description
02282R5000	M8 end connector for EB 80 valves

### BRAIDED EARTH CABLE

Code	Description
02282R6000	Braided earth cable



## EB 80 BOXI - 4-POSITION VALVE ISLAND



TECHNICAL DATA									
Supply voltage range	V			12 -10%	24 +30%				
Minimum operating voltage	V			10.8 *					
Maximum operating voltage	V			31.2					
Maximum admissible voltage	V			32 ***					
Power for each controlled pilot	W			3 for 15 ms, then holding 0.3					
Drive				PNP					
Solenoid rating				100% ED					
Protection				Overload and short-circuit protected solenoid pilot Output					
Grounding				With a Ø3 mm screw on a metal closing plate					
Diagnostics				LED light signal on the base					
Faults signalled				Solenoid pilot broken or missing; short-circuited solenoid pilot;					
				power supply out of range					
Maximum number of controls (solenoid pilots)				4-control version, 5/2 monostable valves;					
				8-control version, for each type of valve.					
Electrical connection				Multipole with D-Sub 9-pin connector;					
				I/O Link with M12x1 connector.					
Ambient temperature	°C			-10 to + 50 (at 8 bar)					
	°F			14 to 122 (at 8 bar)					
Operating pressure				<b>5/2 and 5/3</b>				<b>2/2 and 3/2</b>	
Non-assisted valves	bar			3 to 8				3.5 to 8	
	MPa			0.3 to 0.8				0.35 to 0.8	
	psi			43 to 116				51 to 116	
Assisted valves	bar			Vacuum to 10					
	MPa			Vacuum to 1					
	psi			Vacuum to 145					
Servo pressure	bar			3 to 8				min. (see graph on general catalogue) / max. 8	
	MPa			0.3 to 0.8				min. (see graph on general catalogue) / max. 0.8	
	psi			43 to 116				min. (see graph on general catalogue) / max. 116	
Pneumatic fittings				Supply (port 1) and exhaust (ports 3 and 5): 1/4" G (BSP) or 1/4" NPT.					
				Piloting (X): M5					
Pneumatic outputs				Pipe fittings Ø 4 (5/32"), 6, 8 (5/16"), 1/4"					
Flow rate at 6.3 bar ΔP 1 bar Feeding (port 1)	l/min			4500					
6.3 bar flow rate with free exhaust from ports 3 and 5	l/min			5500 + 5500					
Valve flow rate, at 6.3 bar ΔP 1 bar				<b>Ø 4 (5/32")</b>	<b>Ø 6</b>	<b>Ø 8 (5/16")</b>	<b>Ø 1/4"</b>	<b>Ø 10 **</b>	<b>Ø 3/8" **</b>
	valve 2/2	l/min		350	430	500	430	-	-
	valve 3/2	l/min		350	600	700	600	1250	1250
	valve 5/2	l/min		350	650	800	650	1250 - 1400	1250 - 1400
	valve 5/3	l/min		350	460	500	460	1000 - 1250	1000 - 1250
	valve V3V (R)	l/min		-	-	-	-	1000	1000
Actuation response time (TRA) / reset response time (TRR) at 6 bar									
	TRA/TRR valve 2/2 and 3/2	ms					14 / 28		
	TRA/TRR valves 5/2 monostable and shut-off valve	ms					12 / 45		
	TRA/TRR valve 5/2 bistable	ms					12 / 14		
	TRA/TRR valve 5/3	ms					15 / 45		
	TRA/TRR valve 3/2 high flow	ms					13 / 36		
Fluid							Unlubricated air		
Air quality required							ISO 8573-1 class 4-7-3		
Degree of protection							IP65		
Weight (without valves)	g						330		

\* Minimum voltage 10.8V required at solenoid pilots. Check the minimum voltage at the power pack output using the calculations shown on general catalogue

\*\* Using high-flow valves or connected valves.

\*\*\* IMPORTANT! Voltage greater than 32VDC will damage the system irreparably.

**EB 80 BOXI WITH D-Sub 9-PIN MULTIPOLE ELECTRICAL CONNECTION**

		Code	
T - Pipe fitting	4 CONTROLS	8 CONTROLS	
<b>Port threads 1, 3, 5 in G (BSP)</b>			
<b>Servo-assisted</b>	without cartridges	0228BGX4M1111	0228BGX8M1111
	Ø 4 (5/32")	0228BGX4M4444	0228BGX8M4444
	Ø 6	0228BGX4M6666	0228BGX8M6666
	Ø 8 (5/16")	0228BGX4M8888	0228BGX8M8888
	Ø 1/4"	0228BGX4M2222	0228BGX8M2222
<b>Non-servo-assisted</b>	without cartridges	0228BG14M1111	0228BG18M1111
	Ø 4 (5/32")	0228BG14M4444	0228BG18M4444
	Ø 6	0228BG14M6666	0228BG18M6666
	Ø 8 (5/16")	0228BG14M8888	0228BG18M8888
	Ø 1/4"	0228BG14M2222	0228BG18M2222
<b>Port threads 1, 3, 5 in NPT</b>			
<b>Servo-assisted</b>	without cartridges	0228BUX4M1111	0228BUX8M1111
	Ø 4 (5/32")	0228BUX4M4444	0228BUX8M4444
	Ø 6	0228BUX4M6666	0228BUX8M6666
	Ø 8 (5/16")	0228BUX4M8888	0228BUX8M8888
	Ø 1/4"	0228BUX4M2222	0228BUX8M2222
<b>Non-servo-assisted</b>	without cartridges	0228BU14M1111	0228BU18M1111
	Ø 4 (5/32")	0228BU14M4444	0228BU18M4444
	Ø 6	0228BU14M6666	0228BU18M6666
	Ø 8 (5/16")	0228BU14M8888	0228BU18M8888
	Ø 1/4"	0228BU14M2222	0228BU18M2222

**EB 80 BOXI WITH ELECTRICAL CONNECTION I/O link (M12x1)**

		Code	
T - Pipe fitting	4 CONTROLS	8 CONTROLS	
<b>Port threads 1, 3, 5 in G (BSP)</b>			
<b>Servo-assisted</b>	without cartridges	0228BGX8L1111	0228BGX8L4444
	Ø 4 (5/32")	0228BGX8L4444	0228BGX8L6666
	Ø 6	0228BGX8L6666	0228BGX8L8888
	Ø 8 (5/16")	0228BGX8L8888	0228BGX8L2222
	Ø 1/4"	0228BGX8L2222	
<b>Non-servo-assisted</b>	without cartridges	0228BG18L1111	0228BG18L4444
	Ø 4 (5/32")	0228BG18L4444	0228BG18L6666
	Ø 6	0228BG18L6666	0228BG18L8888
	Ø 8 (5/16")	0228BG18L8888	0228BG18L2222
	Ø 1/4"	0228BG18L2222	
<b>Port threads 1, 3, 5 in NPT</b>			
<b>Servo-assisted</b>	without cartridges	0228BUX8L1111	0228BUX8L4444
	Ø 4 (5/32")	0228BUX8L4444	0228BUX8L6666
	Ø 6	0228BUX8L6666	0228BUX8L8888
	Ø 8 (5/16")	0228BUX8L8888	0228BUX8L2222
	Ø 1/4"	0228BUX8L2222	
<b>Non-servo-assisted</b>	without cartridges	0228BU18L1111	0228BU18L4444
	Ø 4 (5/32")	0228BU18L4444	0228BU18L6666
	Ø 6	0228BU18L6666	0228BU18L8888
	Ø 8 (5/16")	0228BU18L8888	0228BU18L2222
	Ø 1/4"	0228BU18L2222	

**KEY TO CODING OF THE EB 80 BOXI WITHOUT VALVES**

0228B FAMILY	G PORT THREADS 1, 3, 5	1 PILOTING	8 NUMBER OF SOLENOID PILOT CONTROLS	M ELECTRICAL CONNECTION	4 FITTINGS			
					1° position (from left)	2° position	3° position	4° position
0228B EB 80 BOXI	G 1/4" G (BSP) U 1/4" NPT	1 Non-servo-assisted X Servo-assisted	4 4 controls 8 8 controls	M D-Sub 9-pin multipole connection ▲ L I/O link, M12x1	1 Without cartridges 2 Pipe fitting Ø 1/4" 4 Pipe fitting Ø 4 (5/32") 6 Pipe fitting Ø 6 8 Pipe fitting Ø 8 (5/16")			

▲ Only for version with 8 commands.

**KEY TO CODING OF THE EB 80 BOXI COMPLETE WITH VALVES**

0228B FAMILY	G PORT THREADS 1, 3, 5	1 PILOTING	8 NUMBER OF SOLENOID PILOT CONTROLS	M ELECTRICAL CONNECTION	4 FITTINGS				0 MANUAL CONTROL	V V K I VALVES
					1° position (from left)	2° position	3° position	4° position		
0228B EB 80 BOXI	G 1/4" G (BSP) U 1/4" NPT	1 Non-servo-assisted X Servo-assisted	4 4 controls 8 8 controls	M D-Sub 9-pin multipole connection ▲ L I/O link, M12x1	1 Without cartridges 2 Pipe fitting Ø 1/4" 4 Pipe fitting Ø 4 (5/32") 6 Pipe fitting Ø 6 8 Pipe fitting Ø 8 (5/16")			0 Monostable 1 Bistable	▲ Z 2 valves 2/2 NC ▲ I 2 valves 3/2 NC ▲ W 2 valves 3/2 NO ▲ L 3/2 NC + 3/2 NO V 5/2 monostable ▲ K 5/2 bistable ▲ O 5/3 CC G 3/2 NC high flow J 3/2 NO high flow + Shut-off valve Y Bypass N Dummy valve (plug)	

▲ Only for version with 8 commands.

+ Requires inlet port X slave synchronisation.

## ACCESSORIES

### STRAIGHT IP65 9-PIN PLUG CONNECTOR KIT

Code	Description	Weight [g]
02269G0000	Straight D-Sub 9-PIN IP65 connector kit	20

### PRE-WIRED STRAIGHT IP65 9-PIN PLUG CONNECTOR KIT

Code	Description	Weight [g]
02269G0100	Straight D-Sub 9-PIN IP65 connector + cable L = 1 m	80
02269G0250	Straight D-Sub 9-PIN IP65 connector + cable L = 2.5 m	170
02269G0500	Straight D-Sub 9-PIN IP65 connector + cable L = 5 m	320
02269G1000	Straight D-Sub 9-PIN IP65 connector + cable L = 10 m	620
02269H0100*	Straight D-Sub 9-PIN IP65 connector, UL H-FLEX CL6, cable L = 1 m	80
02269H0250*	Straight D-Sub 9-PIN IP65 connector, UL H-FLEX CL6, cable L = 2.5 m	170
02269H0500*	Straight D-Sub 9-PIN IP65 connector, UL H-FLEX CL6, cable L = 5 m	320
02269H1000*	Straight D-Sub 9-PIN IP65 connector, UL H-FLEX CL6, cable L = 10 m	620

\* Mobile laying cable, class 6 according to IEC 60228

### STRAIGHT IP40 9-PIN PLUG CONNECTOR KIT

Code	Description	Weight [g]
0226180102	Straight D-Sub 9-PIN connector kit	20

### CABLE

Code	Description	Weight [g/m]
0226107201	10-PIN cable	60

Specify the number of metres desired.

### PRE-WIRED STRAIGHT IP40 9-PIN PLUG CONNECTOR KIT

Code	Description	Weight [g]
0226900100	Straight D-Sub 9-PIN connector + cable L = 1 m	80
0226900250	Straight D-Sub 9-PIN connector + cable L = 2.5 m	170
0226900500	Straight D-Sub 9-PIN connector + cable L = 5 m	320
0226900750	Straight D-Sub 9-PIN connector + cable L = 7.5 m	470
0226901000	Straight D-Sub 9-PIN connector + cable L = 10 m	620
0226901500	Straight D-Sub 9-PIN connector + cable L = 15 m	920
0226902000	Straight D-Sub 9-PIN connector + cable L = 20 m	1220
0226905000	Straight D-Sub 9-PIN connector + cable L = 50 m	3020

## SPARE PARTS

### CARTRIDGE

Code	Description	Ø
02282R2001	EB 80 Ø 4 base square cartridge kit	4 (5/32")
02282R2002	EB 80 Ø 6 base square cartridge kit	6
02282R2003	EB 80 Ø 8 base square cartridge kit	8 (5/16")
02282R2006	EB 80 Ø 1/4 base square cartridge kit	1/4"

Comes in 10-pc. packs

### BASE-VALVE GASKET

Code	Description
02282R1002	EB 80 base-valve gasket kit

Comes in 10-pc. packs

### PRE-WIRED 90° IP40 9-PIN PLUG CONNECTOR

Code	Description	Weight [g]
0226910100	90° D-Sub 9-PIN connector + cable L = 1 m	80
0226910250	90° D-Sub 9-PIN connector + cable L = 2.5 m	170
0226910500	90° D-Sub 9-PIN connector + cable L = 5 m	320
0226910750	90° D-Sub 9-PIN connector + cable L = 7.5 m	470
0226911000	90° D-Sub 9-PIN connector + cable L = 10 m	620
0226911500	90° D-Sub 9-PIN connector + cable L = 15 m	920

### STRAIGHT CONNECTOR FOR M12, A-CODED

Code	Description
W0970513001	5-PIN M12x1 straight connector

Note: Can be used for IO-Link

### STRAIGHT CONNECTOR WITH WIRE FOR M12, A-CODED

Code	Description
W0970513002	5-PIN M12x1 straight connector with wire L = 5 m

Note: Can be used for IO-Link

### 90° CONNECTOR FOR M12, A-CODED

Code	Description
W0970513003	M12x1 5-PIN 90° connector

Note: Can be used for IO-Link

### 90° CONNECTOR WITH WIRE FOR M12, A-CODED

Code	Description
W0970513004	M12x1 5-PIN 90° connector with wire L = 5 m

Note: Can be used for IO-Link

### T-CONNECTOR M12 A-CODED / M8 MALE FOR AUXILIARY POWER

Code	Description
0240009070	T - connector for auxiliary power

Note: Can be used for IO-Link

### GASKETS BETWEEN BASE AND COVER SHEET METAL

Code	Description
02282R1006	EB 80 BOXI kit of gaskets between base and cover sheet metal

Comes in 10-pc. packs

### FIXING FOOT

Code	Description
02282R4002	EB 80 BOXI fixing foot

Comes in 3-pc. packs

## EB 80 MULTI-FUNCTION MODULE

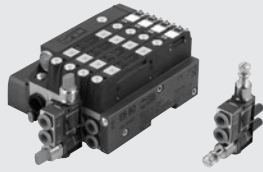

TECHNICAL DATA	
Operating pressure	bar 10 MPa 1 psi 145
Temperature range	°C -10 to +50 °F 14 to 122
Fluid	Unlubricated air
Air quality required	ISO 8573-1 class 4-7-3
Functions	Unidirectional flow regulator, bidirectional flow regulator, pressure regulator, quick-relief valve, check valve, 2- or 3-way shut-off valve, pneumatic valve, pressure display, calibrated choke.
Air inlet	Tubes for Ø 8 mm fittings
Air delivery	Cartridge fittings for pipes Ø 4 (5/32"), Ø 6, Ø 1/4", Ø 8 (5/16")
Recommended pipe	Rilsan PA 11 - Nylon 6 - Polyamide 12 - Polypropylene

**N.B.:** For more specific technical data, please refer to the chapters for individual function-modules

### KEY TO CODES

02282 FAMILY	L SUBSYSTEM	6 FITTINGS	610 FUNCTION PORT 2 (Top)	410 FUNCTION PORT 4 (Bottom)
02282 EB 80	L Multi-function module	2 Pipe fitting Ø 1/4" 4 Pipe fitting Ø 4 (5/32") 6 Pipe fitting Ø 6 8 Pipe fitting Ø 8 (5/16")	000 NF - No function 410 RFL - Flow regulator unidirectional 411 RFL - Flow regulator bidirectional 610 REG - Pressure regulator 630 VSRC - Quick-exhaust valve, conveyed 631 VSRS - Quick-exhaust valve, silenced 632 VSRR - Quick-exhaust valve, regulated 640 VNR - Check valve 650 V2V - 2-way shut-off valve 660 V3V - 3-way shut-off valve 670 PNV - 3-way pneumatic valve 671 P2V - Unidirectional 2-way pneumatic valve 680 LAM - Orange pressure indicator 682 LAM - Green pressure indicator 7_ * RFF - Calibrated choke unidirectional - type V 8_ * RFF - Calibrated choke bidirectional - type B	000 NF - No function 410 RFL - Flow regulator unidirectional 411 RFL - Flow regulator bidirectional 610 REG - Pressure regulator 630 VSRC - Quick-exhaust valve, conveyed 631 VSRS - Quick-exhaust valve, silenced 632 VSRR - Quick-exhaust valve, regulated 640 VNR - Check valve 650 V2V - 2-way shut-off valve 660 V3V - 3-way shut-off valve 670 PNV - 3-way pneumatic valve 671 P2V - Unidirectional 2-way pneumatic valve 680 LAM - Orange pressure indicator 682 LAM - Green pressure indicator 7_ * RFF - Calibrated choke unidirectional - type V 8_ * RFF - Calibrated choke bidirectional - type B

\* The last two digits indicate the narrowing Ø.

02 = Ø 0.2 mm	05 = Ø 0.5 mm	10 = Ø 1.0 mm
03 = Ø 0.3 mm	06 = Ø 0.6 mm	13 = Ø 1.3 mm
04 = Ø 0.4 mm	08 = Ø 0.8 mm	15 = Ø 1.5 mm

## SPARE PARTS

### CARTRIDGE

Code	Description	Ø
02282R2001	EB 80 Ø 4 base square cartridge kit	4 (5/32")
02282R2002	EB 80 Ø 6 base square cartridge kit	6
02282R2003	EB 80 Ø 8 base square cartridge kit	8 (5/16")
02282R2006	EB 80 Ø 1/4 base square cartridge kit	1/4"

Comes in 10-pc. packs

## EB 80 SPLASH AREA



TECHNICAL DATA	
General technical data	See page 124
Protection rating at the splash-area side	IP67
Versions	3 to 8 positions; 8 to 12 positions
Bases configurable with this number of valves	For maximum 8-position version: 3, 4, 6, 7, 8 valves For the maximum 12-position version: 8, 9, 10, 11, 12 valves
Pneumatic fittings	1/4" supply and discharge M5 piloting 1/8" delivery

N.B.: The valve island to be used with the splash-area must be configured with Ø8 mm fittings on ports 2 and 4 and Ø12 mm fittings on ports 1, 3 and 5.

### KEY TO CODES

02282 FAMILY	R CATEGORY	7 SUBSYSTEM	08 NUMBER OF POSITIONS	0 MATERIAL
02282 EB 80	R Spares and accessories	7 Splash-area	08 8 positions 12 12 positions	0 Anodized aluminum plate 6082 1 Plate AISI 304

Code	Description	Weight [g]
02282R7080	EB 80 splash-area kit 3-8 positions aluminum	919
02282R7081	EB 80 splash-area kit 3-8 positions stainless steel	2354
02282R7120	EB 80 splash-area kit 8-12 positions aluminum	1189
02282R7121	EB 80 splash-area kit 8-12 positions stainless steel	3046

### NOTE

## HDM + MULTI-POLE CONNECTION

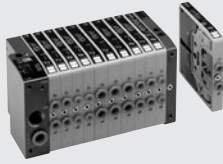

TECHNICAL DATA						
Valve port connections		Ø 4,6,8,10 mm automatic fitting for ports 2 and 4 / power supply port for Ø 10 or Ø 12 mm automatic fitting / 3/8 thread for exhaust port, M5 thread for exhaust pilot port				
Connection on the end-plate for the supply of pilots		Automatic fitting Ø 4 mm				
Maximum number of pilots		16				
Maximum number of valves		16 (same as the max. no. of pilots)				
Operating temperature range	°C	-10 to +60				
Fluid		Filtered air without lubrication; lubrication, if used, must be continuous				
Pressure range	bar	X (pilot supply)		1-11 (valve supply)		
	Terminal 1-1	3 to 7		vacuum at 10		
	Terminal 1			3 to 7		
Voltage range		24 VDC ± 10%				
Power	W	0.9				
Control		PNP o NPN				
Insulation class		F155				
Degree of protection		IP65 (with conveyed exhaust)				
Solenoid rating		100% ED				
Flow rate at 6.3 bar ΔP 1 bar	Nl/min	11.5 mm Ø 4	11.5 mm Ø 6	14 mm Ø 8	23 mm Ø 8	23 mm Ø 10
	version 5/2 and 3/2	200	500	650	1000	1200
	version 5/3	200	300	300	500	500
TRA/TRR 2x3/2 monostable at 6 bar	ms		8 / 45			8 / 60
TRA/TRR 5/2 monostable at 6 bar	ms		8 / 33			9 / 60
TRA/TRR 5/2 bistable at 6 bar	ms		20 / 20			8 / 8
TRA/TRR 5/3 cc monostable at 6 bar	ms		20 / 20			15 / 15
Note on use		Insert the pipes in the fittings, before passing air through the valves, otherwise the basket may be pulled out of its seat by the flow of air. Refer to page 146 for valves, intermediates elements and common accessories.				

### SYNOPTIC, SIZES AND VERSIONS

H D M VALVE	2 INPUT END-PLATE	8 ELECTRICAL BASE	M MANUAL TYPE	16 - W 8 - W 6 - O 4 - L 8 - 5 TYPE OF VALVE	1 4 - 1 6 FURTHER DETAILS
Heavy duty Multimach IP65	2 End-plate 1-11 pipe Ø 10 3 End-plate 1 pipe Ø 10 2S End-plate 1-11 pipe Ø 12	8 D-Sub 25 wire	M Monostable manual control B Bistable manual control	I n° 2 3/2 NC W n° 2 3/2 NO L 3/2 NO + 3/2 NC V 5/2 monostable K 5/2 bistable O 5/3 monostable *F 5/2 monostable 4 right-end-plate 1-11 pipe Ø12 5 blind end-plate 6 Passing-intermediate 7 Blind intermediate 20 Exhaust section 4 Cartridge 4 6 Cartridge 6 8 Cartridge 8 - 14 mm 8S Cartridge 8 - 23 mm 10 Cartridge 10	14 IP65 25-wire shell 16 n° 2 brackets for DIN bar

\* Uses a single PIN (like the V) and occupies 2 signals.

#### END-PLATE 1-11-25D

Code	Description	Weight [g]
0227301200	End-plate HDM 1-11-25D Ø 10	370
0227301220	End-plate HDM 1-11-25D Ø 12	370

This end-plate allows for supplies to be differentiated

- Port 2
- Port 4
- Pilot supply

#### END-PLATE 1-25D - PIPE Ø 10

Code	Description	Weight [g]
0227301201	End-plate HDM 1-25D Ø 10	370

## ACCESSORIES

#### 45° CONNECTOR KIT, 25 WIRES IP65

Code	Description	Weight [g]
0226180107	45° connector kit, 25 wires IP 65	65

#### IDENTIFICATION PLATE KIT

Code	Description
0226107000	Identification plate kit

Package: 16 pieces

#### PRE-WIRED 45° CONNECTOR KIT, 25 WIRES IP65

Code	Description	Weight [g]
0226960100	Connector IP 65 + 25-wire 45° cable L = 1 m	190
0226960250	Connector IP 65 + 25-wire 45° cable L = 2.5 m	390
0226960500	Connector IP 65 + 25-wire 45° cable L = 5 m	740

#### CABLES

Code	Description	Weight [g/m]
0226107201	10-wire cable	60
0226107101	19-wire cable	122
0226107102	25-wire cable	130

Specify the number of metres desired.



## HDM + AS-Interface



### TECHNICAL DATA

Valve port connections	Ø 4,6,8,10 mm automatic fitting for ports 2 and 4 / power supply port for Ø10 or 12* automatic fitting / 3/8 thread for exhaust port, M5 thread for exhaust pilot port
Maximum number of pilots	Terminal with 1 node = 4 / terminal with 2 node = 8
Maximum number of valves	Terminal with 1 node = 4 ( same as the max. no. of pilots ) / terminal with 2 node = 8 (same as the max. no. of pilots)
Notes	If you use valves 8S type or 10 exploiting their low capacity it is necessary that the feeding pressure is at least 6 bar (to avoid the pressure to decrease too much on the pilots). *with right-end-plate 1-11

For valves technical data see HDM+multi-pole connection.  
Refer to page 146 for valves, intermediates elements and common accessories.

### SYNOPTIC, SIZES AND VERSIONS

H D M VALVE	3 INPUT END-PLATE	A S - 4 ELECTRICAL BASE	M MANUAL TYPE	16 - W 8 - W 6 - O 4 - L 8 - 5 TYPE OF VALVE	1 6 FURTHER DETAILS
Heavy duty Multimach IP65	3 End-plate 1	Version with standard address <b>AS-4</b> 1 node, 4 out, yellow cable <b>AS-8</b> 2 nodes, 8 out, yellow cable <b>AO-4</b> 1 node, 4 out e 4 in M8, yellow cable <b>AP-4</b> 1 node, 4 out e 4 in M12, yellow cable <b>AZ-4</b> 1 node, 4 out, yellow cable and black cable <b>AZ-8</b> 2 nodes, 8 out, yellow cable and black cable <b>AE-4</b> 1 node, 4 out e 4 in M8, yellow cable and black cable <b>AE-8</b> 2 nodes, 8 out e 8 in M8, yellow cable and black cable	<b>M</b> Monostable manual control <b>B</b> Bistable manual control	<b>I</b> n° 2 3/2 NC <b>W</b> n° 2 3/2 NO <b>L</b> 3/2 NO + 3/2 NC <b>V</b> 5/2 monostable <b>K</b> 5/2 bistable <b>O</b> 5/3 monostable <b>*F</b> 5/2 monostable <b>4</b> right-end-plate 1-11 pipe Ø12 <b>5</b> blind end-plate <b>6</b> Passing-intermede <b>7</b> Blind intermediate <b>20</b> Exhaust section <b>4</b> Cartridge 4 <b>6</b> Cartridge 6 <b>8</b> Cartridge 8 - 14 mm <b>8S</b> Cartridge 8 - 23 mm <b>10</b> Cartridge 10	<b>16</b> n° 2 brackets for DIN bar

\* Uses a single PIN (like the V) and occupies 2 signals

#### END-PLATE 1 AS-4, AS-8

Code	Description	Weight [g]
0227301202	End-plate HDM 1 AS-4 1 node, 4 Out, yellow cable	465
0227301208	End-plate HDM 1 AS-8 2 nodes, 8 Out, yellow cable	454

#### END-PLATE 1 AP-4, M12

Code	Description	Weight [g]
0227301212	End-plate HDM 1 AP-4 1 node, 4 Out and 4 In M12, yellow cable	756

#### END-PLATE 1 AE-8, M8

Code	Description	Weight [g]
0227301216	End-plate HDM 1 AE-8 2 nodes, 8 Out and 8 In M8, yellow cable and black cable	773

#### END-PLATE 1 AO-4, M8

Code	Description	Weight [g]
0227301218	End-plate HDM 1 AO-4 1 node, 4 Out and 4 In M8, yellow cable	759

#### END-PLATE 1 AE-4, M8

Code	Description	Weight [g]
0227301214	End-plate HDM 1 AE-4 1 node, 4 Out and 4 In M8, yellow cable and black cable	761

#### END-PLATE 1 AZ-4, AZ-8

Code	Description	Weight [g]
0227301204	End-plate HDM 1 AZ-4 1 node, 4 Out, yellow cable and black cable	467
0227301210	End-plate HDM 1 AZ-8 2 nodes, 8 Out, yellow cable and black cable	456

## ACCESSORIES

#### AS-interface ADDRESS CONNECTOR KIT

Code	Description
0226950150	AS-interface address connector cable L = 1 m

#### M8 - M12 PLUG

Code	Description
0240009039	Plug M8
0240009040	Plug M12

#### AS-interface CONNECTOR KIT

Code	Description
0226950151	AS-interface connector kit

## HDM + PROFIBUS-DP

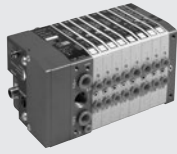

### TECHNICAL DATA

Valve port connections	Ø 4, 6, 8, 10 mm automatic fitting for ports 2 and 4 / power supply port for Ø 10 or 12* automatic fitting / 3/8 thread for exhaust port, M5 thread for exhaust pilot port
Maximum number of pilots	16
Maximum number of valves	16 (same as the max. no. of pilots)
Voltage range	24 VDC ±10% (slave protected against overload and reverse polarity)
Degree of protection	IP65 (with conveyed exhaust, and that - in case of no use - the BUS OUT connector gets plugged)
Notes	*with right-end-plate 1-11
<b>Profibus DP module for HDM valves</b>	
Protection	Outputs protected against overloads and shortcircuits
Max input power (all valves ON)	~500 mA
Addressing	By rotary selectors
Highest settable address number	99
Default address	3
Peripheral defect diagnosis	Local LED indicator and relay to Master
Defects reported	Output shortcircuit or overload. Auxiliary power supply failure. Profibus communication active.
Module status in the event of peripheral defect	The "peripheral defect" bit is active and accessible at the master station.
Data bit value	0 = not enabled - 1 = enabled
Output status in the absence of communication	Disabled

For valves technical data see HDM+multi-pole connection.

Refer to page 146 for valves, intermediates elements and common accessories.

### SYNOPTIC, SIZES AND VERSIONS

H D M VALVE	2 INPUT END-PLATE	P ELECTRICAL BASE	M MANUAL TYPE	16 - W 8 - W 6 - O 4 - L 8 - 5 TYPE OF VALVE	1 6 FURTHER DETAILS
Heavy duty Multi-mach IP65	2 End-plate 1-11 3 End-plate 1	P profibus-DP	M Monostable manual control B Bistable manual control	I n° 2 3/2 NC W n° 2 3/2 NO L 3/2 NO + 3/2 NC V 5/2 monostable K 5/2 bistable O 5/3 monostable *F 5/2 monostable 4 right-end-plate 1-11 pipe Ø12 5 blind end-plate 6 Passing-intermediate 7 Blind intermediate 20 Exhaust section 4 Cartridge 4 6 Cartridge 6 8 Cartridge 8 - 14 mm 8S Cartridge 8 - 23 mm 10 Cartridge 10	16 n° 2 brackets for DIN bar

\* Uses a single PIN (like the V) and occupies 2 signals.

#### END-PLATE 1-11 PROFIBUS-DP

Code	Description	Weight [g]
0227301231	End-plate HDM 1-11 PROFIBUS	730

#### END-PLATE 1 PROFIBUS-DP

Code	Description	Weight [g]
0227301230	End-plate HDM 1 PROFIBUS	730

## ACCESSORIES

#### M8 CONNECTOR FOR POWER SUPPLY

Code	Description
0240009060	M8 4-pin female connector for power supply, cable L = 3 m
0240009037	M8 4-pin female connector for power supply, cable L = 5 m
0240009058	M8 4-pin female connector for power supply, cable L = 10 m
0240009059	M8 4-pin female connector for power supply, cable L = 15 m
0240009P60 *	M8 4-pin female connector for power supply, H-FLEX CL6, cable L = 3 m
0240009P37 *	M8 4-pin female connector for power supply, H-FLEX CL6, cable L = 5 m
0240009P58 *	M8 4-pin female connector for power supply, H-FLEX CL6, cable L = 10 m
0240009P59 *	M8 4-pin female connector for power supply, H-FLEX CL6, cable L = 15 m

\* Mobile laying cable, class 6 according to IEC 60228

#### M12 MALE CONNECTOR OUT-BUS

Code	Description
0240009035	Male connector B coding

#### M12 FEMALE CONNECTOR IN-BUS

Code	Description
0240009036	M12 female connector B coding

#### M8 - M12 PLUG

Code	Description
0240009039	Plug M8
0240009040	Plug M12

## HDM + EtherNet/IP



TECHNICAL DATA	
Valve port connections	Ø 4,6,8,10 mm automatic fitting for ports 2 and 4 / power supply port for Ø10 or 12* automatic fitting / 3/8 thread for exhaust port, M5 thread for exhaust pilot port
Maximum number of pilots	16
Maximum number of valves	16 (same as the max. no. of pilots)
Voltage range	24 VDC ±10% (slave protected against overload and reverse polarity)
Degree of protection	IP65 (with conveyed exhaust, and that - in case of no use - the BUS OUT connector gets plugged) *with right-end-plate 1-11
<b>EtherNet/IP module for HDM valves</b>	
Field buses	EtherNet/IP - 10/100 Mbit/s - Half-duplex - Full-duplex - Supports Auto-Negotiation
Factory settings	Module name: Cmseries - Address IP 192.168.192.30
Addressing	Software DHCP/BOOTP
Voltage range	24VDC ± 10%
Maximum number of pilots (Out)	16
Maximum number of valves	16 (depending on the maximum number of solenoids)
Icc bus supply current	Nominal Icc 120 mA - Instantaneous Icc (< 2 ms) 450 mA
Maximum absorption of a valve distribution block with 16 mono-stable valves	Nominal Icc with 120mA OFF valves - Nominal Icc with 580 mA ON valves
Protections	Module protected against overload and polarity reversal. Outputs protected against overloads and short-circuits
Connections	Field bus: 2 M12 Female, D-coded, internal switch Supply: M8 4 pin - input: M8 3 pin 0 = not enabled - 1 = enabled
Data bit value	Disabled
Output status in the absence of communication	Disabled
For valves technical data see HDM+multi-pole connection. Refer to page 146 for valves, intermediates elements and common accessories.	

### SYNOPTIC, SIZES AND VERSIONS

H D M VALVE	2 INPUT END-PLATE	EN ELECTRICAL BASE	M MANUAL TYPE	16 - W 8 - W 6 - O 4 - L 8 - 5 TYPE OF VALVE	1 6 FURTHER DETAILS
Heavy duty	2 End-plate 1-11	EN EtherNet/IP	M Monostable manual control	I n° 2 3/2 NC	16 n° 2 brackets for DIN bar
Multimach	3 End-plate 1		B Bistable manual control	W n° 2 3/2 NO	
IP65				L 3/2 NO + 3/2 NC	
				V 5/2 monostable	
				K 5/2 bistable	
				O 5/3 monostable	
				*F 5/2 monostable	
				4 right-end-plate 1-11 pipe Ø 12	
				5 blind end-plate	
				6 Passing-intermede	
				7 Blind intermediate	
				20 Exhaust section	
				4 Cartridge 4	
				6 Cartridge 6	
				8 Cartridge 8 - 14 mm	
				85 Cartridge 8 - 23 mm	
				10 Cartridge 10	

\* Uses a single PIN (like the V) and occupies 2 signals.

#### END-PLATE 1-11 EtherNet/IP

Code	Description	Weight [g]
0227301242	End-plate HDM 1-11 EtherNet/IP	730

#### END-PLATE 1 EtherNet/IP

Code	Description	Weight [g]
0227301243	End-plate HDM 1 EtherNet/IP	730

## ACCESSORIES

### M8 CONNECTOR FOR POWER SUPPLY

Code	Description
0240009060	M8 4-pin female connector for power supply, cable L = 3 m
0240009037	M8 4-pin female connector for power supply, cable L = 5 m
0240009058	M8 4-pin female connector for power supply, cable L = 10 m
0240009059	M8 4-pin female connector for power supply, cable L = 15 m
0240009P60 *	M8 4-pin female connector for power supply, H-FLEX CL6, cable L = 3 m
0240009P37 *	M8 4-pin female connector for power supply, H-FLEX CL6, cable L = 5 m
0240009P58 *	M8 4-pin female connector for power supply, H-FLEX CL6, cable L = 10 m
0240009P59 *	M8 4-pin female connector for power supply, H-FLEX CL6, cable L = 15 m

\* Mobile laying cable, class 6 according to IEC 60228

### M12 PLUG

Code	Description
0240009040	Plug M12

### M12 BUS CONNECTOR, D-CODED

Code	Description
0240005051	M12 BUS connector, D-coded
Note: Can be used for BUS units in the EtherNet family (Profinet IO, EtherCAT, EtherNet/IP....)	

### BUS CABLE

Code	Description
0240005220	BUS cable L = 20 m
Note: Can be used for BUS units in the EtherNet family (Profinet IO, EtherCAT, EtherNet/IP....)	

### STRAIGHT CONNECTOR FOR M12-M12 BUS, D-CODED

Code	Description
0240005103	Straight connector for M12-M12 BUS, D-coded, with 3 m cable
0240005105	Straight connector for M12-M12 BUS, D-coded, with 5 m cable
0240005110	Straight connector for M12-M12 BUS, D-coded, with 10 m cable
Note: Can be used for BUS units in the EtherNet family (Profinet IO, EtherCAT, EtherNet/IP....)	

### STRAIGHT CONNECTOR FOR M12 BUS, D-CODED

Code	Description
0240005093	Straight connector for M12 BUS, D-coded, with 3 m cable
0240005095	Straight connector for M12 BUS, D-coded, with 5 m cable
0240005100	Straight connector for M12 BUS, D-coded, with 10 m cable
Note: Can be used for BUS units in the EtherNet family (Profinet IO, EtherCAT, EtherNet/IP....)	

### RJ45 CONNECTOR

Code	Description
0240005050	RJ45 connector with 4 contacts according to IEC 60 603-7

## HDM + CANopen

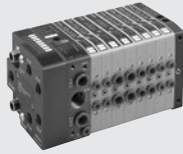

TECHNICAL DATA	
Valve port connections	Ø 4, 6, 8, 10 mm automatic fitting for ports 2 and 4 / power supply port for Ø10 or 12* automatic fitting / 3/8 thread for exhaust port, M5 thread for exhaust pilot port
Maximum number of pilots	16
Maximum number of valves	16 (same as the max. no. of pilots)
Voltage range	24 VDC ±10% (slave protected against overload and reverse polarity)
Degree of protection	IP65 (with conveyed exhausts and with not used connectors plugged)
Notes	* with right-end-plate 1-11
<b>CANopen module for HDM valves</b>	
Protection	Outputs protected against overloads and shortcircuits
Max input power (all valves ON)	~800 mA
Addressing	By DIP SWITCH
Highest settable address number	127
Default address	1
Peripheral defect diagnosis	Local LED indicator and relay to Master
Defects reported	Output shortcircuit or overload. Auxiliary power supply failure.
Module status in the event of peripheral defect	CANopen communication active. The "peripheral defect" bit is active and accessible at the master station.
Data bit value	0 = not enabled 1 = enabled
Output status in the absence of communication	Disabled
<b>INPUT module for HDM valves</b>	
Sensor supply voltage	24 VDC ±10% (depending on the supply of the CANopen module)
Max sensor power (distributed over eight connectors) mA	40
Type of input	PNP for sensor 2-3 wires according to EN 60947-5-2
Protection	Protected inputs against overload and short-circuit
Active INPUT signalling	One LED for each INPUT

For valves technical data see HDM+multi-pole connection.  
Refer to page 146 for valves, intermediates elements and common accessories.

### SYNOPTIC, SIZES AND VERSIONS

H D M VALVE	2 INPUT END-PLATE	CAN O ELECTRICAL BASE	M MANUAL TYPE	16 - W 8 - W 6 - O 4 - L 8 - 5 TYPE OF VALVE	1 6 FURTHER DETAILS
Heavy duty Multimach IP65	2 End-plate 1-11 3 End-plate 1	CAN O CANopen 16 OUTPUT CAN I/O CANopen 8 INPUT e 16 OUTPUT	M Monostable manual control B Bistable manual control	I n° 2 3/2 NC W n° 2 3/2 NO L 3/2 NO + 3/2 NC V 5/2 monostable K 5/2 bistable O 5/3 monostable *F 5/2 monostable 4 right-end-plate 1-11 pipe Ø12 5 blind end-plate 6 Passing-intermede 7 Blind intermediate 20 Exhaust section 4 Cartridge 4 6 Cartridge 6 8 Cartridge 8 - 14 mm 8S Cartridge 8 - 23 mm 10 Cartridge 10	16 n° 2 brackets for DIN bar

\* Uses a single PIN (like the V) and occupies 2 signals.

#### END-PLATE 1-11 CANopen O

Code	Description	Weight [g]
0227301251	End-plate 1-11 HDM CANopen OUTPUT Handles 16 OUTPUTS (solenoid pilots)	745

#### END-PLATE 1-11 CANopen I/O

Code	Description	Weight [g]
0227301250	End-plate 1-11 HDM CANopen IN-OUT Handles 16 OUTPUTS (solenoid pilots)	734

#### END-PLATE 1 CANopen O

Code	Description	Weight [g]
0227301253	End-plate 1 HDM CANopen OUTPUT Handles 16 OUTPUTS (solenoid pilots)	746

#### END-PLATE 1 CANopen I/O

Code	Description	Weight [g]
0227301252	End-plate 1 HDM CANopen IN-OUT Handles 16 OUTPUTS (solenoid pilots)	735

## ACCESSORIES FOR HDM+CANopen

### STRAIGHT CONNECTOR FOR CANopen POWER SUPPLY

Code	Description
W0970513001	Acc. 5-pin M12x1 straight connector

### FEMALE CONNECTOR FOR CANopen BUS-IN

Code	Description
0240009055	M12 female connector, A coding

### STRAIGHT CONNECTOR WITHOUT CABLE FOR CANopen INPUT

Code	Description
0240009021	Straight fitting without cable

### Y-DISTRIBUTOR WITH CABLE AND M12 STRAIGHT CONNECTORS FOR CANopen INPUT

Code	Description
0240009031	Y-Distributor cable 0.6 m
0240009032	Y-Distributor cable 1.5 m

### STRAIGHT CONNECTOR WITH CANopen POWER CABLE

Code	Description
W0970513002	Acc. 5-pin M12x1 straight connector with wire L = 5 m

### MALE CONNECTOR FOR CANopen BUS-OUT

Code	Description
0240009038	Male connector Bus A coding

### STRAIGHT CONNECTOR WITH CABLE FOR CANopen INPUT

Code	Description
0240009002	Straight, with 1.5 m cable
0240009003	Straight, with 5 m cable

### M12 PLUG FOR BUS OUT E INPUT CANopen

Code	Description
0240009002	Plug M12

## HDM + B&R

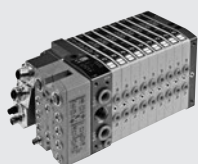

### IP20 7XV--50-11 SMART CONNECTOR

It is a plug connector with IP20 protection that contains the X system electronics. It can be connected with HDM islands, using the special input end-plate, type 1, code 0227301207 or the special input end-plate type 1-11, code 0227301206.



### IP67 7XV--50-51 SMART CONNECTOR

It is a plug connector with IP67 protection, that contains the X system electronics. It can be connected with HDM islands, using the special input end-plate type 1, code 0227301207, or the special input end-plate, type 1-11 code 0227301206.



### X67 1/O SYSTEM MODULES

These are modules with IP67 protection, connected to the X system, for handling inputs and outputs. It is interesting to note that their size is such that they can be fixed directly to the HDM input end-plate type 1-11, code 0227301206 (N.B. NOT to be fixed to the HDM end-plate type 1, code 0227301207).

### X67 BUS CONTROLLER MODULES

These are modules with protection IP67, receiving a signal according to one of the DP Profibus, CAN open, Device Net, Ethernet Powerlink protocols (the module code differs obviously according to the protocol being controlled). The output signal is according to the X-system. These are gateways converting the signals of a field bus into an X-system. These modules control the inputs and/or outputs via the M8 connectors provided. They can be fixed directly to the HDM input end-plate type 1-11, code 0227301206 (N.B. NOT to be fixed to the HDM end-plate, type 1, code 0227301207).

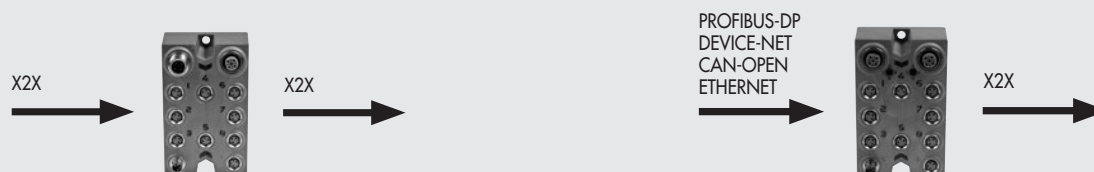

### SYNOPTIC, SIZES AND VERSIONS

H D M VALVE	2 INPUT END-PLATE	B & R ELECTRICAL BASE	M MANUAL TYPE	16 - W 8 - W 6 - O 4 - L 8 - 5 TYPE OF VALVE	1 6 FURTHER DETAILS
Heavy duty Multimach IP65	2 End-plate 1-11 3 End-plate 1	B&R Fit for B&R	M Monostable manual control B Bistable manual control	I n° 2 3/2 NC W n° 2 3/2 NO L 3/2 NO + 3/2 NC V 5/2 monostable K 5/2 bistable O 5/3 monostable *F 5/2 monostable 4 Right-end-plate 1-11 pipe Ø12 5 Blind end-plate 6 Passing-intermediate 7 Blind intermediate 20 Exhaust section 4 Cartridge 4 6 Cartridge 6 8 Cartridge 8 - 14 mm 8S Cartridge 8 - 23 mm 10 Cartridge 10	16 n° 2 brackets for DIN bar

\* Uses a single PIN (like the V) and occupies 2 signals.

### HDM 1-11 END-PLATE FOR B&R

Code	Description	Weight [g]
0227301206	HDM 1-11 end-plate kit for B&R	340



### HDM 1 END-PLATE FOR B&R

Code	Description	Weight [g]
0227301207	HDM 1 end-plate kit for B&R	380

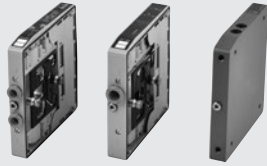
## HDM - VALVES, INTERMEDIATES ELEMENTS AND ACCESSORIES

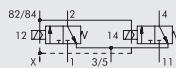
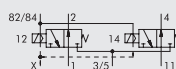
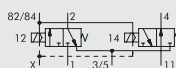
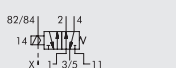
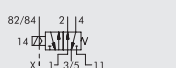

### VALVES HDM

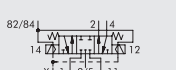
Symbol	Ø	Code	Manual control	Weight [g]
	4	707103053		130
	6	707203053		130
	8	707303053	final 0 monostable manual	140
	8S	707703053	final 1 bistable manual	260
	10	707803053		250
	4	707103063		130
	6	707203063		130
	8	707303063	final 0 monostable manual	140
	8S	707703063	final 1 bistable manual	260
	10	707803063		250
	4	707103073		130
	6	707203073		130
	8	707303073	final 0 monostable manual	140
	8S	707703073	final 1 bistable manual	260
	10	707803073		250
	4	707103013		115
	6	707203013		115
	8	707303013	final 0 monostable manual	130
	8S	707703013	final 1 bistable manual	241
	10	707803013		231
	4	707103053		115
	6	707203053		115
	8	707303053	final 2 monostable manual	130
	8S	707703053	final 3 bistable manual	241
	10	707803053		231
	4	707103011		130
	6	707203011		130
	8	707303011	final 0 monostable manual	140
	8S	707703011	final 1 bistable manual	253
	10	707803011		243
	4	707103021		130
	6	707203021		130
	8	707303021	final 0 monostable manual	140
	8S	707703021	final 1 bistable manual	262
	10	707803021		252

### INTERMEDIATE THROUGH

Code	Description	Weight [g]
0227301301	Intermediate through HDM	120

### INTERMEDIATE BLIND

Code	Description	Weight [g]
0227301302	Intermediate blind HDM	117

### INTERMEDIATE EXHAUST SWITCH

Code	Description	Weight [g]
0227301303	Intermediate exhaust switch HDM	125

### RIGHT-END-PLATE 1-11 PIPE Ø 12

Code	Description	Weight [g]
0227301221	Rigth-end-plate HDM 1-11 Ø 12	630

### BLIND END-PLATE

Code	Description	Weight [g]
0227301500	Blind end-plate HDM	230

## ACCESSORIES

### CONNECTION BRACKETS ON DIN BAR

Code	Description	Weight [g]
0227301600	Connection brackets on DIN bar HDM/CM	30

### SILENCER FOR FITTING, Ø 8

Code	Description	Weight [g]
W0970530084	Silencer for fitting, Ø 8	8

At the 3/5-exhaust port of the intermediate and of the intermediate exhaust switch

### R17 - PIPE RELEASE SPANNER

Code	Rif.	Ø Tube
2L17001	RL17	from 3 to 10
2017001	R17	from 4 to 14

## SPARE PARTS

### GRUB SCREW KIT

Code	Description
0227301800	Grub screw for Multimach HDM/CM



## mm MULTIMACH

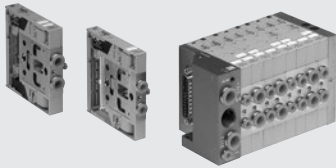

TECHNICAL DATA		
Valve port connections	Ø 4, 6, 8 mm automatic fitting for ports 2 and 4 / power supply port for Ø 8 or Ø 10 automatic fitting / 3/8 thread for exhaust port, M5 thread for exhaust pilot port	
Connection on the end-plate for the supply of pilots	Automatic fitting Ø 4	
Operating temperature range	°C -10 to +60	
Fluid	Filtered air without lubrication; lubrication, if used, must be continuous	
Flow rate at 6 bar ΔP 1bar	Nl/min	11 mm Ø 4: 200      11 mm Ø 6: 500      14 mm Ø 8: 700
Voltage range	24 VDC ±10%	
Power	W 1.2	
Insulation class	F155	
Degree of protection	IP51	
Solenoid rating	100% ED	
Pressure range	X (pilot supply) 3 to 7 max	1-11 (valve supply) vacuum at 10 bar
	Terminal 1-11	bar
	Terminal 1	bar
	Terminal 1 reduced	bar
TRA/TRR 2x3/2 monostable at 6 bar	ms	
TRA/TRR 5/2 monostable at 6 bar	ms	
TRA/TRR 5/2 bistable at 6 bar	ms	
TRA/TRR 5/3 cc monostable at 6 bar	ms	
Note on use	Insert the pipes in the fittings, before passing air through the valves, otherwise the basket may be pulled out of its seat by the flow of air.	

### SYNOPTIC, SIZES AND VERSIONS

M 5 1 VALVE	2 INPUT END-PLATE	8 ELECTRICAL BASE	16 - W 8 - W 6 - O 4 - L 8 - 5 TYPE OF VALVE	1 4 FURTHER DETAILS
Multimach IP51	2 End-plate 1-11 3 End-plate 1 4 Reduced End-plate 1	8 Axial 25-wire connector base 9 Axial 9-wire connector base 10 25-wire rear connector base 11 9-wire rear connector base	I n° 2 3/2 NC W n° 2 3/2 NO L 3/2 NO + 3/2 NC V 5/2 monostable K 5/2 bistable O 5/3 monostable 5 Blind end-plate 6 Passing-intermediate 7 Blind intermediate 20 Exhaust section 4 Cartridge 4 6 Cartridge 6 8 Cartridge 8	12 9-wire connector 14 25-wire connector 16 Brackets for DIN bar

#### VALVE

Symbol	Ø	Code	Manual control	Weight [g]
	4	7068030532	monostable	118
	6	7069030532	monostable	110
	8	7070030532	monostable	124
	4	7068030632	monostable	118
	6	7069030632	monostable	110
	8	7070030632	monostable	124
	4	7068030732	monostable	118
	6	7069030732	monostable	110
	8	7070030732	monostable	124
	4	7068030132	monostable	100
	6	7069030132	monostable	90
	8	7070030132	monostable	105
	4	7068030112	monostable	114
	6	7069030112	monostable	107
	8	7070030112	monostable	120
	4	7068030212	monostable	115
	6	7069030212	monostable	108
	8	7070030212	monostable	121

#### END-PLATE 1-11

Code	Description	Weight [g]
0227300200	End-plate kit 1-11	223

This end-plate allows for supplies to be differentiated: port 2, port 4 and pilot supply

#### END-PLATE 1

Code	Description	Weight [g]
0227300201	End-plate kit 1	224

#### REDUCED END-PLATE 1

Code	Description	Weight [g]
0227300300	Reduced end-plate kit 1	148

**BLIND END-PLATE**

Code	Description	Weight [g]
0227300500	Blind end-plate	168

**INTERMEDIATE THROUGH**

Code	Description	Weight [g]
0227300301	Intermediate through	92

**INTERMEDIATE BLIND**

Code	Description	Weight [g]
0227300302	Intermediate blind	89

**INTERMEDIATE EXHAUST SWITCH**

Code	Description	Weight [g]
0227300303	Intermediate exhaust switch	95

**AXIAL CONNECTOR BASE, 25 WIRES**

Code	Description	Weight [g]
0226180001	Axial connector base kit, 25 wires	54

**AXIAL CONNECTOR BASE, 9 WIRES**

Code	Description	Weight [g]
0226180002	Axial connector base kit, 9 wires	51

**REAR CONNECTOR BASE, 25 WIRES**

Code	Description	Weight [g]
0226180003	Rear connector base kit, 25 wires	73

**REAR CONNECTOR BASE, 9 WIRES**

Code	Description	Weight [g]
0226180004	Rear connector base kit, 9 wires	77

**STRAIGHT AND 90° CONNECTOR KIT, 9 WIRES**

Code	Description	Weight [g]
0226180102	Straight and 90° connector kit, 9 wires	31

**STRAIGHT AND 90° CONNECTOR KIT, 25 WIRES**

Code	Description	Weight [g]
0226180101	Straight and 90° connector kit, 25 wires	48

**CONNECTION BRACKETS ON THE BAR OMEGA (DIN EN 50022)**

Code	Description	Weight [g]
0227300600	Connection brackets on DIN bar	8

**CONNECTOR KIT + WIRE**

Code	Description	Weight [g]
0226180399	Connector kit + wire 1-6*	3
0226180400	Connector kit + wire 7-12**	4
0226180401	Connector kit + wire 13-30***	5

- \* For valve connection from 1st to 6th position counting from the connector
- \*\* For valve connection from 7th to 12th position, counting from the connector
- \*\*\* For valve connection from 13th to 30th position, counting from the connector

**SILENCER FOR FITTING, Ø 8**

Code	Description	Weight [g]
W0970530084	Silencer for fitting, Ø 8	15

At the 3/5-exhaust port of the reduced end-plate 1, and of the intermediate through, or intermediate exhaust switch

**STRAIGHT PRE-WIRED CONNECTOR KIT**

Code	Description	Weight [g]
0226900100	Straight D-Sub 9-PIN connector + cable L = 1 m	80
0226900250	Straight D-Sub 9-PIN connector + cable L = 2.5 m	170
0226900500	Straight D-Sub 9-PIN connector + cable L = 5 m	320
0226900750	Straight D-Sub 9-PIN connector + cable L = 7.5 m	470
0226901000	Straight D-Sub 9-PIN connector + cable L = 10 m	620
0226901500	Straight D-Sub 9-PIN connector + cable L = 15 m	920
0226902000	Straight D-Sub 9-PIN connector + cable L = 20 m	1220
0226905000	Straight D-Sub 9-PIN connector + cable L = 50 m	3020

0226920100	Straight D-Sub 25-PIN connector + cable L = 1 m	132
0226920250	Straight D-Sub 25-PIN connector + cable L = 2.5 m	320
0226920500	Straight D-Sub 25-PIN connector + cable L = 5 m	636

**PRE-WIRED 90° CONNECTOR**

Code	Description	Weight [g]
0226910100	90° D-Sub 9-PIN connector + cable L = 1 m	80
0226910250	90° D-Sub 9-PIN connector + cable L = 2.5 m	170
0226910500	90° D-Sub 9-PIN connector + cable L = 5 m	320
0226910750	90° D-Sub 9-PIN connector + cable L = 7.5 m	470
0226911000	90° D-Sub 9-PIN connector + cable L = 10 m	620
0226911500	90° D-Sub 9-PIN connector + cable L = 15 m	920

0226930100	90° D-Sub 25-PIN connector + cable L = 1 m	132
0226930250	90° D-Sub 25-PIN connector + cable L = 2.5 m	320
0226930500	90° D-Sub 25-PIN connector + cable L = 5 m	636

**MALE CONNECTOR KIT + CONTACTS + COMMON TERMINAL**

Code	Description
0226180201	Male connector kit - 25 pins
0226180202	Male connector kit - 9 pins

**GRUB SCREW**

Code	Description
0227300800	Grub screw for Multimach

Comes in 10-pc. pack

**CABLES**

Cod.	Description	Weight [g]
0226107201	10-wire cable	86
0226107101	19-wire cable	122
0226107102	25-wire cable	130

Specify the number of metres desired

**IDENTIFICATION PLATE KIT**

Code	Description
0226107000	Identification plate kit

Comes in 16-pc. packs

**R17 - PIPE RELEASE SPANNER**

Code	Description	Ø Tube
2L17001	RL17	from Ø 3 to Ø 10

**MULTIMACH + B&R**



**MULTIMACH CONNECTOR SUPPORT FOR B&R**

Code	Description	Weight [g]
0226180005	25-pin connector support kit for B&R	140

## PROFIBUS-DP FOR MULTIMACH AND BASES FOR PLT-10



TECHNICAL DATA	
Supply voltage	24 VDC + 20% - 15%
EMC and ESD test	in compliance with IEC 801-2/IEC 801/4 (up to level 3: 8kV/2kV)
Resistance to vibration and impacts test	according to IEC68-2-6/IEC 68-2-27 (1g/12g)
Operating temperature range	0 to 60 °C
Storage temperature	- 40 to + 85 °C
Admitted relative humidity	95%
Assembly	35 mm DIN bar

### SLAVE PROFIBUS-DP

Code	Description
0240004003	Slave PROFIBUS-DP
<b>Technical data</b>	
PROFIBUS-DP Interface	RS485: 9 pins D-Sub
Transmission speed	9.6 kBaud up to 12 Mbaud
Max number of modules which can be connected	32 (depending on the maximum current)
Nominal supply voltage	24 VDC
Absorption 24V	70 mA

### 8-DIGITAL OUTPUT MODULE

Code	Description
0240004051	DO 8XDC24V 0.5A unit
<b>Technical data</b>	
Nominal voltage	24 VDC
Number of outputs	8
Output data	1 Byte
Absorption for each channel	1A (max 8A)
Internal Bus voltage	5V
Absorption 5V BUS	70 mA

### 8-DIGITAL INPUT MODULE

Code	Description
0240004053	DI 8XDC24V unit
<b>Technical data</b>	
Nominal input voltage	24 VDC
Number of inputs	8
Input data	1 Byte
Input voltage at "1"	15...28.8V
Output voltage at "0"	0...5V
Response time	3 ms
Internal Bus voltage	5V
Absorption 5V BUS	20 mA

### 4-ANALOG INPUT MODULE

Code	Description
0240004054	AL 4X16 BIT unit
<b>Technical data</b>	
Number of Inputs	4
Input data	8 Byte
Input range	Voltage 0 to 50 mV, 0...10V, ± 4 mV, ± 4V, ± 10V, Current 0/4...20 mA, +/-20 mA Temperature Pt100, Pt1000, Ni100, Ni1000 Resistance 60 Ω, 600 Ω, 3000 Ω, 16000 Ω Thermoelements J, K, N, R, T, S
Resolution	12/16 Bit
Input resistance	20M Ω voltage, 85 Ω current
Time	5...70 ms
Internal Bus voltage	5V
Absorption 5V BUS	280 mA

### 4-ANALOG OUTPUT MODULE

Code	Description
0240004055	AO 4X12 BIT unit
<b>Technical data</b>	
Number of outputs	4
Output data	8 Byte
Output range	Voltage 0...10V, ±10V, 1...5V Current 0...20 mA, 4...20 mA, ±20 mA
Resolution	12 BIT
Output resistance	Minimum voltage 1 kΩ, Maximum current 500 Ω
Conversion time	0.45 ms
Internal Bus voltage	5 V
Absorption 5V BUS	75 mA

### 25-PIN PLUG CONNECTOR KIT

Code	Description	Weight [g]
0226180101	25-pin plug connector	48

### 9-PIN PLUG CONNECTOR, STRAIGHT OUTPUT FOR MULTIMACH

Code	Description
0226180102	9-pin plug connector

### CABLES

Code	Description	Weight [g/m]
0226107201	10-wire cable	60
0226107101	19-wire cable	122
0226107102	25-wire cable	130

Indicate the desired length in metres

### STRAIGHT PRE-WIRED CONNECTOR KIT

Code	Description	Weight [g]
0226900100	Straight D-Sub 9-PIN connector + cable L = 1 m	80
0226900250	Straight D-Sub 9-PIN connector + cable L = 2.5 m	170
0226900500	Straight D-Sub 9-PIN connector + cable L = 5 m	320
0226900750	Straight D-Sub 9-PIN connector + cable L = 7.5 m	470
0226901000	Straight D-Sub 9-PIN connector + cable L = 10 m	620
0226901500	Straight D-Sub 9-PIN connector + cable L = 15 m	920
0226902000	Straight D-Sub 9-PIN connector + cable L = 20 m	1220
0226905000	Straight D-Sub 9-PIN connector + cable L = 50 m	3020
0226920100	Straight D-Sub 25-PIN connector + cable L = 1 m	132
0226920250	Straight D-Sub 25-PIN connector + cable L = 2.5 m	320
0226920500	Straight D-Sub 25-PIN connector + cable L = 5 m	636

### PRE-WIRED 90° CONNECTOR

Code	Description	Weight [g]
0226910100	90° D-Sub 9-PIN connector + cable L = 1 m	80
0226910250	90° D-Sub 9-PIN connector + cable L = 2.5 m	170
0226910500	90° D-Sub 9-PIN connector + cable L = 5 m	320
0226910750	90° D-Sub 9-PIN connector + cable L = 7.5 m	470
0226911000	90° D-Sub 9-PIN connector + cable L = 10 m	620
0226911500	90° D-Sub 9-PIN connector + cable L = 15 m	920
0226930100	90° D-Sub 25-PIN connector + cable L = 1 m	132
0226930250	90° D-Sub 25-PIN connector + cable L = 2.5 m	320
0226930500	90° D-Sub 25-PIN connector + cable L = 5 m	636

## CM CLEVER MULTIMACH

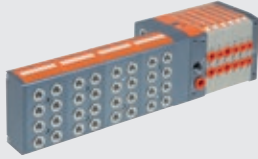

VALVES

CM CLEVER MULTIMACH

TECHNICAL DATA				
Valve port connections		Ø 4,6,8 mm automatic fitting for ports 2 and 4 / power supply port for Ø10 automatic fitting / 3/8 thread for exhaust port, M5 thread for exhaust pilot port		
Connection on the end-plate 1-11 for the supply of pilots		Automatic fitting Ø 4 mm		
Maximum number of pilots		See input end-plate technical data		
Maximum number of valves		See input end-plate technical data		
Operating temperature range	°C	-10 to +60		
Fluid		Filtered air without lubrication; lubrication, if used, must be continuous		
Flow rate at 6.3 bar ΔP 1 bar	Nl/min	11.5 mm Ø 4	11.5 mm Ø 6	14 mm Ø 8
	version 5/2 and 3/2	200	500	650
	version 5/3	200	300	300
Pressure range		X (pilot supply)		1-11 (valve supply)
	end-plate 1-11	3 to 7 bar		vacuum at 10 bar
	end-plate 1	3 to 7 bar		
Voltage range		24 VDC ±10%		
Power for each pilot	W	(slave protected against overload and reverse polarity)		
Solenoid Pilot Insulation class		F155		
Degree of protection		IP65 (with conveyed exhaust, and that - in case of no use)		
Diagnostics and protections		Local via PC/PLC fault led. For defects signalled look at the manual.		
		Outlets protected against overload and short-circuit		
Solenoid rating		100% ED		
Maximum latency time of the serial transmission	ms	<10		
TRA/TRR 2x3/2 monostable at 6 bar	ms	8 / 45		
TRA/TRR 5/2 monostable at 6 bar	ms	8 / 33		
TRA/TRR 5/2 bistable at 6 bar	ms	20 / 20		
TRA/TRR 5/3 cc monostable at 6 bar	ms	20 / 20		
Note on use		Insert the pipes in the fittings, before passing air through the valves, otherwise the gasket may be pulled out of its seat by the flow of air.		
<b>Add-on module</b>				
Sensor supply voltage		24 VDC ±10%		
Maximum current for each single connector	mA	200		
Maximum current for each module	mA	400		
Maximum total current of all the modules	mA	1000		
Input impedance	KΩ	3.9		
Max input voltage	Vcc	-5 to +30		
Type of input		With field bus: PNP		
		With multi-pole connection: PNP/NPN configurable via DIP SWITCH		
Protection		Protected inputs against overload and short-circuit		
Active input signalling		One LED for each INPUT		

### SYNOPTIC, SIZES AND VERSIONS

C M	2	I / O		M	16 - W8 - W6 - O4 - L8 - 5	M8 - M8 - 15 - 16
VALVE	INPUT END-PLATE	FUNCTION		MANUAL TYPE	TYPE OF VALVE	FURTHER DETAILS
Clever	2 End-plate 1-11	O	multi-pole connection, valves only	M	n° 2 3/2 NC	● M8 Module 8 input M8
Multimach	3 End-plate 1	I/O	multi-pole connection, valves and inputs	B	n° 2 3/2 NO	* 14 Shell 44 pin
		ADD	Additional (slave) valves only		L 3/2 NO + 3/2 NC	* 15 Shell 44 + 44 pin
		PN O	Profinet IO, valves only		V 5/2 monostable	16 n° 2 brackets for DIN bar
		PN I/O	Profinet IO, valves and inputs		K 5/2 bistable	
		EC O	EtherCAT, valves only		O 5/3 monostable	
		EC I/O	EtherCAT, valves and inputs		5 Blind end-plate	
		EN O	EtherNet/IP, valves only		6 Passing-intermediate	
		EN I/O	EtherNet/IP, valves and inputs		7 Blind intermediate	
		CAN O	CANopen, valves only		20 Exhaust section	
		CAN I/O	CANopen, valves and inputs		4 Cartridge 4	
					6 Cartridge 6	
					8 Cartridge 8	

- Not applicable with (add-on) ADD end-plate
- \* For multi-pole connection only

## CM + MULTI-POLE CONNECTION



TECHNICAL DATA	
Maximum number of pilots	32
Maximum number of valves	32 (same as the max. no. of pilots)
Voltage range	24VDC ±10%
DC input current without valve modules	Nominal I <sub>cc</sub> 30 mA - Instantaneous I <sub>cc</sub> (≤25 ms) 650 mA
Max input current with all valves ON	A 1.5

For valves technical data see page 150.

Refer to page 156 for valves, intermediates elements and common accessories

### OUTPUT END-PLATE 1-11

Code	Description	Weight [g]
0227302200	End-plate CM kit 1-11 OUT	722
This end-plate allows for supplies to be differentiated: port 2, port 4 and pilot supply		
Note: terminator included		

### INPUT/OUTPUT END-PLATE 1-11

Code	Description	Weight [g]
0227302223	End-plate CM kit 1-11 IN/OUT	722
This end-plate allows for supplies to be differentiated: port 2, port 4 and pilot supply		
Note: terminator included		

### 44-PIN CUP CONNECTOR KIT IP 65

Code	Description	Weight [g]
0226180108	44-pin cup connector kit IP 65	60

### CABLES

Code	Description	Weight [g/m]
0226107201	10-wire cable	86
0226107101	19-wire cable	122
0226107102	25-wire cable	130
0226107103	44-wire cable	160

Specify the number of metres desired

### 44-PIN PRE-WIRED CUP CONNECTOR

Code	Description	Weight [g]
0226950500	Connet. IP 65 + cable 44-wire L = 5 m	740

### OUTPUT END-PLATE 1

Code	Description	Weight [g]
0227302201	End-plate CM kit 1 OUT	722
Note: terminator included		

### INPUT/OUTPUT END-PLATE 1

Code	Description	Weight [g]
0227302225	End-plate CM kit 1 IN/OUT	722
Note: terminator included		

### 44+44 PIN CUP CONNECTOR KIT IP 65 FOR I/O

Code	Description	Weight [g]
0226180109	44+44 pin cup connector kit IP 65 for I/O	80

### IDENTIFICATION PLATE KIT FOR 44-PIN CONNECTOR

Code	Description
0226107000	Identification plate kit
Comes in 10-pc. packs	

### 44+44-PIN PRE-WIRED CUP CONNECTOR

Code	Description	Weight [g]
0226980500	Connet. IP 65 + cable 44 + 44-wire L = 5 m	1550

## CM + Profinet IO



TECHNICAL DATA	
Field buses	Profinet IO - 100 Mbit/s - Full-duplex Supports RT communication, Shared Device, Identification & Maintenance 1-4
Factory settings	Module name: Cmseries Address IP 0.0.0.0
Addressing	Software DCP
Voltage range	24VDC ± 10%
Maximum number of pilots (Out)	64
Maximum number of valves	64 (same as the max. no. of pilots)
Maximum number of inputs (INs)	32
lcc bus supply current	Nominal lcc 120 mA - Instantaneous lcc (< 2 ms) 450 mA
lcc valve supply current	Instantaneous lcc (< 2 ms) 900 mA
Maximum absorption of a valve island with 64 monostable valves	Nominal lcc with 900 mA OFF valves - nominal lcc with 2700 mA ON valves
Protections	Module protected against overload and polarity reversal. Outputs protected against overloads and short-circuits
Connections	Field bus: 2 M12 Female, D-coded, internal switch supply: M8 4 pin input: M8 3 pin
BUS diagnostics	Using local LEDs and software messages Outputs: using local LEDs and status bytes Inputs: using local LEDs and status bytes N.B.: Refer to the user manual for a detailed description
Data bit value	0 = not enabled 1 = enabled
Output status in the absence of communication	Disabled

For valves technical data see page 150.

Refer to page 156 for valves, intermediates elements and common accessories

### END-PLATE 1-11 Profinet IO OUTPUT

Code	Description	Weight [g]
0227302230	End-plate CM 1-11 Profinet IO OUTPUT	683

This end-plate allows for supplies to be differentiated: port 2, port 4 and pilot supply  
Note: terminator included

### END-PLATE 1-11 Profinet IO INPUT/OUTPUT

Code	Description	Weight [g]
0227302232	End-plate CM 1-11 Profinet IO IN/OUT	643

This end-plate allows for supplies to be differentiated: port 2, port 4 and pilot supply  
Note: terminator included

### M8 CONNECTOR FOR POWER SUPPLY

Code	Description
0240009060	M8 4-pin female connector for power supply, cable L = 3 m
0240009037	M8 4-pin female connector for power supply, cable L = 5 m
0240009058	M8 4-pin female connector for power supply, cable L = 10 m
0240009059	M8 4-pin female connector for power supply, cable L = 15 m
0240009P60 *	M8 4-pin female connector for power supply, H-FLEX CL6, cable L = 3 m
0240009P37 *	M8 4-pin female connector for power supply, H-FLEX CL6, cable L = 5 m
0240009P58 *	M8 4-pin female connector for power supply, H-FLEX CL6, cable L = 10 m
0240009P59 *	M8 4-pin female connector for power supply, H-FLEX CL6, cable L = 15 m

\* Mobile laying cable, class 6 according to IEC 60228

### M12 BUS CONNECTOR, D-CODED

Code	Description
0240005051	M12 BUS connector, D-coded

Note: Can be used for BUS units in the EtherNet family (Profinet IO, EtherCAT, EtherNet/IP....)

### STRAIGHT CONNECTOR FOR M12-M12 BUS, D-CODED

Code	Description
0240005103	Straight connector for M12-M12 BUS, D-coded, with 3 m cable
0240005105	Straight connector for M12-M12 BUS, D-coded, with 5 m cable
0240005110	Straight connector for M12-M12 BUS, D-coded, with 10 m cable

Note: Can be used for BUS units in the EtherNet family (Profinet IO, EtherCAT, EtherNet/IP....)

### END-PLATE 1 Profinet IO OUTPUT

Code	Description	Weight [g]
0227302231	End-plate CM 1 Profinet IO OUTPUT	686

Note: terminator included

### END-PLATE 1 Profinet IO INPUT/OUTPUT

Code	Description	Weight [g]
0227302233	End-plate CM 1 Profinet IO IN/OUT	645

Note: terminator included

### M12 PLUG

Code	Description
0240009040	Plug M12

### BUS CABLE

Code	Description
0240005220	BUS cable L = 20 m

Note: Can be used for BUS units in the EtherNet family (Profinet IO, EtherCAT, EtherNet/IP....)

### STRAIGHT CONNECTOR FOR M12 BUS, D-CODED

Code	Description
0240005093	Straight connector for M12 BUS, D-coded, with 3 m cable
0240005095	Straight connector for M12 BUS, D-coded, with 5 m cable
0240005100	Straight connector for M12 BUS, D-coded, with 10 m cable

### RJ45 CONNECTOR

Code	Description
0240005050	RJ45 connector with 4 contacts according to IEC 60 603-7



## CM + EtherCAT



TECHNICAL DATA	
Field buses	EtherCAT - 100 Mbit/s - Full-duplex - Supports auto-negotiation
Factory settings	Module name: Cmseries
Minimum cycle time	100 µs
Addressing	Autoincrement Address - Second Slave Address
Voltage range	24VDC ± 10%
Maximum number of pilots (Out)	64 (8 byte)
Maximum number of valves	64 (same as the max. no. of pilots)
Maximum number of inputs (INs)	32 (4 byte + 1 status byte)
Icc bus supply current	Nominal Icc 120 mA - Instantaneous Icc (< 2 ms) 450 mA
Icc valve supply current	Instantaneous Icc (< 2 ms) 900 mA
Maximum absorption of a valve island with 64 monostable valves	Nominal Icc with 900 mA OFF valves – nominal Icc with 2700 mA ON valves
Protections	Module protected against overload and polarity reversal. Outputs protected against overloads and short-circuits
Connections	Field bus: 2 M12 Female, D-coded, internal switch supply: M8 4 pin input: M8 3 pin
BUS diagnostics	Using local LEDs and software messages Outputs: using local LEDs and status bytes Inputs: using local LEDs and status bytes N.B.: Refer to the user manual for a detailed description
Data bit value	0 = not enabled 1 = enabled
Output status in the absence of communication	Disabled

For valves technical data see page 150.

Refer to page 156 for valves, intermediates elements and common accessories

### END-PLATE 1-11 EtherCAT OUTPUT

Code	Description	Weight [g]
0227302234	End-plate CM 1-11 EtherCAT OUTPUT	683

This end-plate allows for supplies to be differentiated: port 2, port 4 and pilot supply  
Note: terminator included

### END-PLATE 1-11 EtherCAT INPUT/OUTPUT

Code	Description	Weight [g]
0227302236	End-plate CM 1-11 EtherCAT IN/OUT	643

This end-plate allows for supplies to be differentiated: port 2, port 4 and pilot supply  
Note: terminator included

### M8 CONNECTOR FOR POWER SUPPLY

Code	Description
0240009060	M8 4-pin female connector for power supply, cable L = 3 m
0240009037	M8 4-pin female connector for power supply, cable L = 5 m
0240009058	M8 4-pin female connector for power supply, cable L = 10 m
0240009059	M8 4-pin female connector for power supply, cable L = 15 m
0240009P60 *	M8 4-pin female connector for power supply, H-FLEX CL6, cable L = 3 m
0240009P37 *	M8 4-pin female connector for power supply, H-FLEX CL6, cable L = 5 m
0240009P58 *	M8 4-pin female connector for power supply, H-FLEX CL6, cable L = 10 m
0240009P59 *	M8 4-pin female connector for power supply, H-FLEX CL6, cable L = 15 m

\* Mobile laying cable, class 6 according to IEC 60228

### M12 BUS CONNECTOR, D-CODED

Code	Description
0240005051	M12 BUS connector, D-coded

Note: Can be used for BUS units in the EtherNet family (Profinet IO, EtherCAT, EtherNet/IP....)

### STRAIGHT CONNECTOR FOR M12-M12 BUS, D-CODED

Code	Description
0240005103	Straight connector for M12-M12 BUS, D-coded, with 3 m cable
0240005105	Straight connector for M12-M12 BUS, D-coded, with 5 m cable
0240005110	Straight connector for M12-M12 BUS, D-coded, with 10 m cable

Note: Can be used for BUS units in the EtherNet family (Profinet IO, EtherCAT, EtherNet/IP....)

### END-PLATE 1 EtherCAT OUTPUT

Code	Description	Weight [g]
0227302235	End-plate CM 1 EtherCAT OUTPUT	686

Note: terminator included

### END-PLATE 1 EtherCAT INPUT/OUTPUT

Code	Description	Weight [g]
0227302237	End-plate CM 1 EtherCAT IN/OUT	645

Note: terminator included

### M12 PLUG

Code	Description
0240009040	Plug M12

### BUS CABLE

Code	Description
0240005220	BUS cable L = 20 m

Note: Can be used for BUS units in the EtherNet family (Profinet IO, EtherCAT, EtherNet/IP....)

### STRAIGHT CONNECTOR FOR M12 BUS, D-CODED

Code	Description
0240005093	Straight connector for M12 BUS, D-coded, with 3 m cable
0240005095	Straight connector for M12 BUS, D-coded, with 5 m cable
0240005100	Straight connector for M12 BUS, D-coded, with 10 m cable

### RJ45 CONNECTOR

Code	Description
0240005050	RJ45 connector with 4 contacts according to IEC 60 603-7

## CM + EtherNet/IP



TECHNICAL DATA	
Field buses	EtherNet/IP - 10/100 Mbit/s - Half-duplex - Full-duplex - Supports auto-negotiation
Factory settings	Module name: Cmseries Address IP 0.0.0.0
Addressing	Software DCP
Voltage range	24VDC ± 10%
Maximum number of pilots (Out)	64
Maximum number of valves	64 (same as the max. no. of pilots)
Maximum number of inputs (INs)	32
Icc bus supply current	Nominal Icc 120 mA - Instantaneous Icc (< 2 ms) 450 mA
Icc valve supply current	Instantaneous Icc (< 2 ms) 900 mA
Maximum absorption of a valve island with 64 monostable valves	Nominal Icc with 900 mA OFF valves – nominal Icc with 2700 mA ON valves
Protections	Module protected against overload and polarity reversal. Outputs protected against overloads and short-circuits
Connections	Field bus: 2 M12, D-coded, internal switch supply: M8 4 pin input: M8 3 pin
BUS diagnostics	Using local LEDs and software messages Outputs: using local LEDs and status bytes Inputs: using local LEDs and status bytes N.B.: Refer to the user manual for a detailed description
Data bit value	0 = not enabled 1 = enabled
Output status in the absence of communication	Disabled

For valves technical data see page 150.

Refer to page 156 for valves, intermediates elements and common accessories

### END-PLATE 1-11 EtherNet/IP OUTPUT

Code	Description	Weight [g]
0227302242	End-plate CM 1-11 EtherNet/IP OUTPUT	683

This end-plate allows for supplies to be differentiated: port 2, port 4 and pilot supply  
Note: terminator included

### END-PLATE 1-11 EtherNet/IP INPUT/OUTPUT

Code	Description	Weight [g]
0227302244	End-plate CM 1-11 EtherNet/IP IN/OUT	643

This end-plate allows for supplies to be differentiated: port 2, port 4 and pilot supply  
Note: terminator included

### M8 CONNECTOR FOR POWER SUPPLY

Code	Description
0240009060	M8 4-pin female connector for power supply, cable L = 3 m
0240009037	M8 4-pin female connector for power supply, cable L = 5 m
0240009058	M8 4-pin female connector for power supply, cable L = 10 m
0240009059	M8 4-pin female connector for power supply, cable L = 15 m
0240009P60 *	M8 4-pin female connector for power supply, H-FLEX CL6, cable L = 3 m
0240009P37 *	M8 4-pin female connector for power supply, H-FLEX CL6, cable L = 5 m
0240009P58 *	M8 4-pin female connector for power supply, H-FLEX CL6, cable L = 10 m
0240009P59 *	M8 4-pin female connector for power supply, H-FLEX CL6, cable L = 15 m

\* Mobile laying cable, class 6 according to IEC 60228

### M12 BUS CONNECTOR, D-CODED

Code	Description
0240005051	M12 BUS connector, D-coded

Note: Can be used for BUS units in the EtherNet family (Profinet IO, EtherCAT, EtherNet/IP....)

### STRAIGHT CONNECTOR FOR M12-M12 BUS, D-CODED

Code	Description
0240005103	Straight connector for M12-M12 BUS, D-coded, with 3 m cable
0240005105	Straight connector for M12-M12 BUS, D-coded, with 5 m cable
0240005110	Straight connector for M12-M12 BUS, D-coded, with 10 m cable

Note: Can be used for BUS units in the EtherNet family (Profinet IO, EtherCAT, EtherNet/IP....)

### END-PLATE 1 EtherNet/IP OUTPUT

Code	Description	Weight [g]
0227302243	End-plate CM 1 EtherNet/IP OUTPUT	686

Note: terminator included

### END-PLATE 1 EtherNet/IP INPUT/OUTPUT

Code	Description	Weight [g]
0227302245	End-plate CM 1 EtherNet/IP IN/OUT	645

Note: terminator included

### M12 PLUG

Code	Description
0240009040	Plug M12

### BUS CABLE

Code	Description
0240005220	BUS cable L = 20 m

Note: Can be used for BUS units in the EtherNet family (Profinet IO, EtherCAT, EtherNet/IP....)

### STRAIGHT CONNECTOR FOR M12 BUS, D-CODED

Code	Description
0240005093	Straight connector for M12 BUS, D-coded, with 3 m cable
0240005095	Straight connector for M12 BUS, D-coded, with 5 m cable
0240005100	Straight connector for M12 BUS, D-coded, with 10 m cable

### RJ45 CONNECTOR

Code	Description
0240005050	RJ45 connector with 4 contacts according to IEC 60 603-7

## CM + CANopen



TECHNICAL DATA	
Field buses	CANopen - Complies with CiA DS401 specifications
Factory settings	Module name: Cmseries Address 4
Addressing	Hardware via dip Switch
Voltage range	24VDC ± 10%
Maximum number of pilots (Out)	64
Maximum number of valves	* 64 (same as the max. no. of pilots)
Maximum number of inputs (INs)	32
Icc bus supply current	Nominal Icc 30 mA - Instantaneous Icc (< 5 ms) 640 mA
Icc valve supply current	Instantaneous Icc (< 5 ms) 1100 mA
Maximum absorption of a valve island with 64 monostable valves	Nominal Icc with 900 mA OFF valves – nominal Icc with 2700 mA ON valves
Protections	Module protected against overload and polarity reversal. Outputs protected against overloads and short-circuits
Connections	Field bus: M12 Male inputs, 5 pins, A-coded; M12 Female outputs, 5 poles, A-coded supply: M8 4 pin input: M8 3 pin
BUS diagnostics	Using local LEDs and software messages Outputs: using local LEDs and status bytes Inputs: using local LEDs and status bytes N.B.: Refer to the user manual for a detailed description
Data bit value	0 = not enabled 1 = enabled
Output status in the absence of communication	Disabled

For valves technical data see page 150.

Refer to page 156 for valves, intermediates elements and common accessories

### END-PLATE 1-11 CANopen OUTPUT

Code	Description	Weight [g]
0227302238	End-plate CM 1-11 CANopen OUTPUT	678

This end-plate allows for supplies to be differentiated: port 2, port 4 and pilot supply  
Note: terminator included

### END-PLATE 1-11 CANopen INPUT/OUTPUT

Code	Description	Weight [g]
0227302240	End-plate CM 1-11 CANopen IN/OUT	632

This end-plate allows for supplies to be differentiated: port 2, port 4 and pilot supply  
Note: terminator included

### FEMALE CONNECTOR FOR CANopen BUS-IN

Code	Description
0240009055	M12 female connector, A-coded

### CABLE FOR CANopen BUS

Code	Description
0240005250	Cable for CANopen bus 20 m

### END-PLATE 1 CANopen OUTPUT

Code	Description	Weight [g]
0227302239	End-plate CM 1 CANopen OUTPUT	680

Note: terminator included

### END-PLATE 1 CANopen INPUT/OUTPUT

Code	Description	Weight [g]
0227302241	End-plate CM 1 CANopen IN/OUT	635

Note: terminator included

### MALE CONNECTOR FOR CANopen BUS-OUT

Code	Description
0240009038	M12 male connector, A-coded

## CM + VALVES, INTERMEDIATES ELEMENTS AND ACCESSORIES

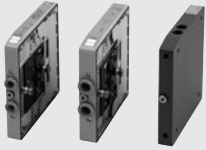

### VALVE CM

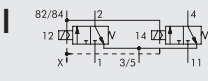
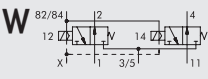
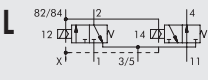
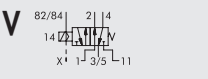
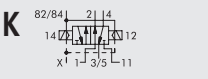
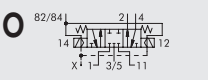
Symbol	Ø	Code	Manual control	Weight [g]
	4	707403053		130
	6	707503053	final 0 monostable manual	130
	8	707603053	final 1 bistable manual	140
	4	707403063		130
	6	707503063	final 0 monostable manual	130
	8	707603063	final 1 bistable manual	140
	4	707403073		130
	6	707503073	final 0 monostable manual	130
	8	707603073	final 1 bistable manual	140
	4	707403013		115
	6	707503013	final 0 monostable manual	115
	8	707603013	final 1 bistable manual	130
	4	707403011		130
	6	707503011	final 0 monostable manual	130
	8	707603011	final 1 bistable manual	140
	4	707403021		130
	6	707503021	final 0 monostable manual	130
	8	707603021	final 1 bistable manual	140

### ADDITIONAL END-PLATE 1-11

Code	Description	Weight [g]
0227302224	End-plate CM kit 1-11 ADD	770

This end-plate allows for supplies to be differentiated: port 2, port 4 and pilot supply

### ADDITIONAL END-PLATE 1

Code	Description	Weight [g]
0227302226	End-plate CM kit 1 ADD	770

### BLIND END-PLATE

Code	Description	Weight [g]
0227302500	Blind end-plate CM	230

### INTERMEDIATE THROUGH

Code	Description	Weight [g]
0227302301	Intermediate through CM	120

### INTERMEDIATE BLIND

Code	Description	Weight [g]
0227302302	Intermediate blind CM	117

### INTERMEDIATE EXHAUST SWITCH

Code	Description	Weight [g]
0227302303	Intermediate exhaust switch CM	125

### CONNECTION BRACKETS ON DIN BAR

Code	Description	Weight [g]
0227301600	Connection brackets on DIN bar HDM/CM	30

Supplied complete with one M4x45 screws and one grub screw  
Individually packed

### SILENCER FOR FITTING, Ø 8

Code	Description	Weight [g]
W0970530084	Silencer for fitting, Ø 8	15

At the 3/5-exhaust port of the intermediate through reference 6  
and the exhaust switch reference 20

### 8-INPUT M8 ADD-ON MODULE (for BUS) – INPUTS / OUTPUTS (for multi-pole connection)

Code	Description	Weight [g]
0227302900	M8 8-input module CM	273

### M8 PLUG

Code	Description
0240009039	Plug M8

### M8 INPUT CONNECTOR

Code	Description
0240009009	M8-M8 straight connector with 3 m cable

### 8 PREWIRED CONNECTOR FOR VALVE ISLANDS CONNECTIONS

Code	Description
0240005003	M8 prewired connector for valve islands conn. CM L = 5 m
0240005005	M8 prewired connector for valve islands conn. CM L = 1 m
0240005006	M8 prewired connector for valve islands conn. CM L = 3 m
0240005008	M8 prewired connector for valve islands conn. CM L = 10 m

### DISTRIBUTORS M8 INPUT CONNECTOR

Code	Description
0240009010	M8 3-pin straight connector

### GRUB SCREW KIT

Code	Description
0227301800	Grub screw for Multimach HDM/CM

Comes 1 + 1 packs

### R17 - DISASSEMBLY KEY

Code	Description	Ø Tube	Tube
2L17001	RL17	from Ø 3 to Ø 10	For R fitting and Fox fitting

## INPUT PROFIBUS-DP IP67 M8

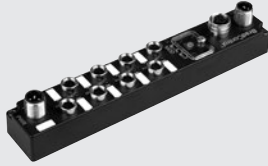

TECHNICAL DATA	
Application	8 PNP inputs
Power supply	24 VDC (13-28 V)
Index of protection	IP67
Temperature range	-20 to +70°C RH 5-95% - no condensate
<b>Field Bus technical data</b>	DP-VO Profibus to EN 50170
Transmission protocol	Synchronous or Freeze-Mode
Transmission mode	Up to 12 MBit/s
Transfer rate	Rotary switches, 1...99
Addresses	PNP proximity sensors or IEE 1131-2 compact mechanical stop
<b>Input technical data</b>	24 VDC (18 to 28 V)
Type	One green LED for each input
Power supply	2...5 V
Signal	10...30 V
Input 0 signal voltage	"NET" LED+alarm signal to master
Input 1 signal voltage	Red LED for each channel at M8 connection point M8 (600 mA)
<b>Diagnosis</b>	
Field bus	
INPUT short-circuit sensor	

### SLAVE IP67

Code	Description
0240008002	IP67 M8 PROFIBUS INPUT

### M12 BUS-IN FEMALE CONNECTOR

Code	Description
0240009036	M12 female connector, B coding

### M12 BUS-OUT MALE CONNECTOR

Code	Description
0240009035	M12 male connector, B coding

### M8 INPUT CONNECTOR WITH CABLE

Code	Description
0240009009	M8-M8 straight connector with 3 m cable

### M8-M12 PLUG

Code	Description
0240009039	M8 plug
0240009040	M12 plug

### M12 STRAIGHT SUPPLY CONNECTOR

Code	Description
W0970513001	5-pin M12x1 straight connector

### M8 INPUT CONNECTOR

Code	Description
0240009010	M8 3-pin straight connector

### M12 90° SUPPLY CONNECTOR

Code	Description
W0970513003	M12x1 5-pin 90° connector

### M12 STRAIGHT SUPPLY CONNECTOR WITH CABLE

Code	Description
W0970513002	5-pin M12x1 straight connector with 5 m cable

### M12 90° SUPPLY CONNECTOR WITH CABLE

Code	Description
W0970513004	M12x1 5-pin 90° connector with 5m cable

## INPUT/OUTPUT PROFIBUS-DP IP 67 M12



TECHNICAL DATA		
Application		8 inputs or outputs + 8 inputs or outputs or diagnostic
Supply voltage		24 VDC (18V.....30,2V), according to EN 61131-2
Degree of protection		IP67
Temperature		0 to 55°C (32 to 131° F)
<b>Field Bus Data</b>	Transmission protocol	Profibus-DP EN 50170
	Transmission mode	synchronous or Freeze-Mode
	Transmission speed	12MBit/s
	Addresses	rotating switches BCD, 0.....99
<b>Inputs Output Technical Data</b>	Type	pnp proximity sensors or EN 61131-2 compatible mechanical limit switch
	Supply	24 VDC (18-30.2V) to EN 61131-2; ≥ 200 mA for M12 coupling point.
	Indicator	One LED for each
<b>Output Technical Data</b>	Voltage	24 VDC (18-30.2V) output, to EN 61131-2; cumulative I ≥ 9A
	Maximum current for each actuator	1.6 A, system protected by fuse in case of short-circuit
	Maximum current contemporary	10W
	Maximum signal exchange frequency	20 Hz Ohm, 20 Hz induction
	Indicator LED	One LED for each output
<b>Autotest</b>	Field bus	RUN-LED
	Insufficient voltage signal	LED + alarm signal to master
	Short-circuit sensor INPUT or OUTPUTS	Red LED for channel on M12 coupling point
<b>Autotest</b>	Desina® (pin 2)	PIN 2 diagnostic with red LED for M12 coupling point and signal to master
		<b>N.B.:</b> for the disposition of the contact, please look at the connectors at the following pages

### SYNOPTIC, SIZES AND VERSIONS SLAVE, COMPLETE WITH SERIES 70 VALVES

B U S	P	V	B	O	O 2	D D
	P Profibus	V IP67	B 70 1/8" C 70 1/4"	O Multiple base	02 2 positions 04 4 positions 06 6 positions 08 8 positions 10 10 positions 12 12 positions 14 14 positions 16 16 positions	D SOV 23 SOS NO - SOV 33 SOS NO H SOV 23 SOS NC - SOV 33 SOS NC Z SOV 23 SOB 00 - SOV 33 SOB 00 M SOV 25 SOS 0 - SOV 35 SOS 00 J SOV 25 SOB 00 - SOV 35 SOB 00 G SOV 26 SOS CC - SOV 36 SOS CC E SOV 26 SOS OC - SOV 36 SOS OC B SOV 26 SOS PC - SOV 36 SOS PC A Blanking plate

### SYNOPTIC, SIZES AND VERSIONS IP67 SLAVE, COMPLETE WITH ISO VALVES

B U S	P	V	D	I	O 2	M M
	P Profibus	V IP67	D ISO1 E ISO2	I Manifold base side	02 2 positions 04 4 positions 06 6 positions 08 8 positions 10 10 positions 12 12 positions 14 14 positions 16 16 positions	M ISV 55 SOS 00 - ISV 65 SOS 00 J ISV 55 SOB 00 - ISV 65 SOB 00 G ISV 56 SOS CC - ISV 66 SOS CC E ISV 56 SOS OC - ISV 66 SOS OC B ISV 56 SOS PC - ISV 66 SOS PC A Blanking plate

### SLAVE IP67

Code	Description
0240008001	8 I/O + 8 I/O/autotest Profibus

## ACCESSORIES

#### 90° ELBOW WITHOUT CABLE

Code	Description
0240009001	90° Elbow without cable

#### FEMALE CONNECTOR FOR FEEDING "OUT"

Code	Description
0240009034	Female connector "OUT" feeding

#### M12 MALE CONNECTOR OUT-BUS

Code	Description
0240009035	M12 male connector B coding

#### PLUG M12

Code	Description
0240009040	M12 plug

#### 90° ELBOW WITH CABLE

Code	Description
0240009022	90° curve with cable 1.5 m
0240009023	90° curve with cable 5 m

#### MALE CONNECTOR FOR FEEDING "IN"

Code	Description
0240009033	Male connector "IN" feeding

#### STRAIGHT FITTING WITHOUT CABLE

Code	Description
0240009021	Straight fitting without cable

#### Y-DISTRIBUTOR WITH CABLE AND M12 STRAIGHT CONNECTORS

Code	Description
0240009031	Y-Distributor cable 0.6 m
0240009032	Y-Distributor cable 1.5 m

#### M12 FEMALE CONNECTOR IN-BUS

Code	Description
0240009036	M12 female connector B coding

#### STRAIGHT FITTING WITH CABLE

Code	Description
0240009002	Straight, with 1.5 m cable
0240009003	Straight, with 5 m cable



## SOLENOID VALVES, SERIES EV-FLUID

### SOLENOID VALVES, SERIES EV-FLUID, DIRECT ACTING



TECHNICAL DATA		NBR	FPM/FKM	EPDM	PTFE
Max operating frequency (with air)	Hz	2			
Power consumption		DC: 5 - 6.5 - 10 - 27 W / AC: 8 - 11 - 15 - 30 VA			
Voltage available		12 - 24VDC / 24 - 110 - 220 VAC 50/60 Hz			
Voltage tolerance	%	DC: ±10 / AC: -10 to +15			
Type of protection		IP 65 with connector			
Fluid temperature	°C	-10 to +90	-10 to +140	-10 to +140	-10 to +180
Ambient temperature	°C	with coil C.I F: -10 to +55; con with coil C.I H: -10 to +80			
Maximum fluid viscosity		25 cSt (mm²/s)			
Pressure range, flow rate, weight		See dimensions and ordering codes			
Maximum coil nut torque	Nm	1.5			
Usable fluids / Materials compatibility		Valves that can be used with neutral or slightly aggressive liquid and gas fluids. (Refer to the tables of chemical compatibility of materials in contact with the fluid on <a href="http://www.metalwork.it">www.metalwork.it</a> or contact Metal Work technical service)			

#### VERSION 2/2 NC, BRASS VALVE BODY

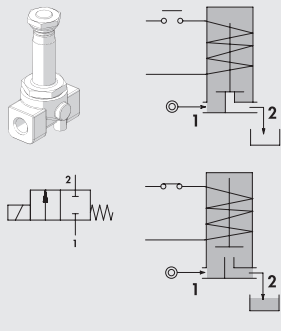

Code	Threaded port	Air hole Ø [mm]	Kv factor [m³/h]	Type of coil	Differential pressure [bar]		Max pressure * [bar]	Weight [g]
					AC	DC		
W_910100001	1/8"	1.5	0.07	2	0 to 30	0 to 26	80	180
W_910100002	1/8"	2	0.1	2	0 to 22	0 to 20	80	180
W_910100010	1/4"	2.5	0.15	2	0 to 16	0 to 14	80	180
W_910100011	1/4"	3.5	0.32	2	0 to 10	0 to 8	80	180
W_910100012	1/4"	4.5	0.41	2	0 to 6.5	0 to 3.5	80	180
W_910100013	1/4"	5.2	0.47	5	0 to 10	0 to 9	80	180
W_910100017	1/4"	6.4	0.64	5	0 to 5	0 to 4.5	80	180
W_910100020	3/8"	4	0.36	2	0 to 8	0 to 5	80	240
W_910100021	3/8"	3.5	0.32	2	0 to 10	0 to 8	80	240
W_910100022	3/8"	4.5	0.41	2	0 to 6.5	0 to 3.5	80	240
W_910100030	1/2"	5.2	0.47	5	0 to 10	0 to 9	80	240
W_910100031	1/2"	6.4	0.64	5	0 to 5	0 to 4.5	80	240
W_910100032	1/2"	3.5	0.32	2	0 to 10	0 to 8	80	240

To complete the code enter: **O** for NBR gaskets **V** for FKM/FPM gaskets \* The maximum allowable pressure for steam is 6 bar with PTFE gaskets and 2.5 bar with EPDM gaskets  
**E** for EPDM gaskets **T** for PTFE gaskets

#### VERSION 2/2 NC, BRASS VALVE BODY AND DIAPHRAGM POPPET

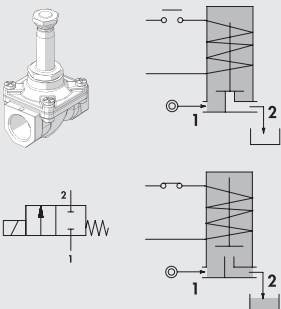

Code	Threaded port	Air hole Ø [mm]	Kv factor [m³/h]	Type of coil	Differential pressure [bar]		Max pressure [bar]	Weight [g]
					AC	DC		
W_910700001	1/2"	12	2.2	5	0 to 0.8	0 to 0.4	5	330
W_910700002	3/4"	18	4.5	5	0 to 0.2	0 to 0.12	5	630

To complete the code enter: **O** for NBR gaskets **V** for FKM/FPM gaskets  
**E** for EPDM gaskets

#### VERSION 2/2 NC, STAINLESS STEEL VALVE BODY

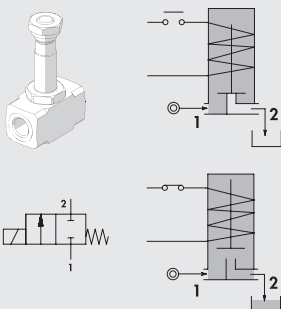

Code	Threaded port	Air hole Ø [mm]	Kv factor [m³/h]	Type of coil	Differential pressure [bar]		Max pressure * [bar]	Weight [g]
					AC	DC		
W_910300001 ▲	1/8"	1.5	0.06	3	0 to 16	0 to 16	50	100
W_910300002 ▲	1/8"	2.5	0.14	3	0 to 8	0 to 5.5	50	100
W_910300003 ▲	1/8"	3.1	0.19	4	0 to 8	0 to 4	50	100
W_910300010	1/4"	2	0.1	2	0 to 22	0 to 20	100	240
W_910300011	1/4"	3.5	0.32	2	0 to 10	0 to 8	100	240
W_910300020	3/8"	3.5	0.32	2	0 to 10	0 to 8	100	240
W_910300021	3/8"	5.2	0.47	5	0 to 10	0 to 9	100	240
W_910300022	3/8"	6.4	0.64	5	0 to 5	0 to 4.5	100	240
W_910300030	1/2"	5.2	0.47	5	0 to 10	0 to 9	100	240
W_910300031	1/2"	6.4	0.64	5	0 to 5	0 to 4.5	100	240
W_910300032	1/2"	3.5	0.32	2	0 to 10	0 to 8	100	240

To complete the code enter: **O** for NBR gaskets **V** for FKM/FPM gaskets \* The maximum allowable pressure for steam is 6 bar with PTFE gaskets and 2.5 bar with EPDM gaskets  
**E** for EPDM gaskets **T** for PTFE gaskets  
▲ Not available in T version (PTFE gasket)

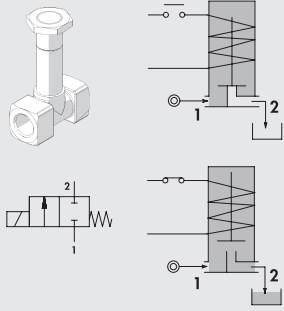
**VERSION 2/2 NC, BRASS BODY WITH BUILT-IN SLEEVE, FKM/FPM GASKETS**

Code	Threaded port	Air hole Ø [mm]	Kv factor [m³/h]	Type of coil	Differential pressure [bar]		Max pressure [bar]	Weight [g]
					AC	DC		
WV910500001	1/8"	1.5	0.06	3	0 to 14	0 to 3	50 *	40
WV910500002	1/4"	3	0.18	2	0 to 14	0 to 6	50 **	100
WV910500003	1/4"	4	0.26	2	0 to 7	0 to 3	50 **	100

\* The maximum allowable pressure for steam is 2.5 bar  
 \*\* The maximum allowable pressure for steam is 6 bar

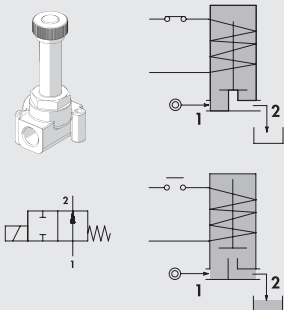
**VERSION 2/2 NO, BRASS VALVE BODY**

Code	Threaded port	Air hole Ø [mm]	Kv factor [m³/h]	Type of coil	Differential pressure [bar]		Max pressure * [bar]	Weight [g]
					AC	DC		
W_910800003	1/8"	2	0.09	3	0 to 8	0 to 8	50	80
W_910800004	1/8"	2.5	0.14	3	0 to 4.5	0 to 4.5	50	80
W_910800008	1/4"	2.5	0.15	2	0 to 12	-	50	180
W_910800009	1/4"	3.5	0.32	2	0 to 7	-	50	180
W_910800010	1/4"	4.5	0.41	2	0 to 4.5	-	50	180
W_910800011	1/4"	5.2	0.47	2	0 to 3	-	50	180
W_910810009	1/4"	3.5	0.32	2	-	0 to 4	50	180
W_910810010	1/4"	4.5	0.41	2	-	0 to 3	50	180
W_910810011	1/4"	5.2	0.47	2	-	0 to 2.2	50	180

To complete the code enter: **0** for NBR gaskets **V** for FKM/FPM gaskets \* The maximum allowable pressure for steam is 2.5 bar  
**E** for EPDM gaskets

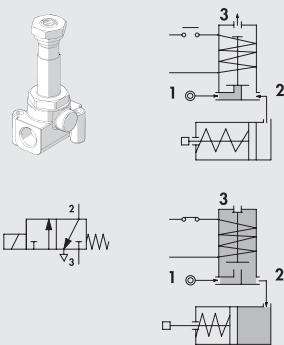
**VERSION 3/2 NC, BRASS VALVE BODY**

Code	Threaded port	Air hole Ø [mm]	Kv factor [m³/h]	Type of coil	Differential pressure [bar]		Max pressure [bar]	Weight [g]
					AC	DC		
W_911000002	1/8"	1.5	0.06	3	0 to 10	0 to 10	11	60
W_911000003	1/8"	2	0.09	3	0 to 6	0 to 6	6.5	60
W_911000004	1/4"	1.5	0.07	2	0 to 20	0 to 20	22	200
W_911000005	1/4"	2	0.11	2	0 to 13	0 to 13	14	200
W_911000006	1/4"	2.5	0.16	2	0 to 10	0 to 10	11	200

To complete the code enter: **0** for NBR gaskets **V** for FKM/FPM gaskets  
**E** for EPDM gaskets

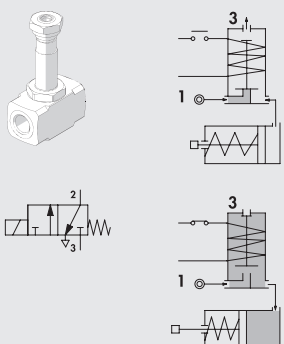
**VERSION 3/2 NC, STAINLESS STEEL VALVE BODY**

Code	Threaded port	Air hole Ø [mm]	Kv factor [m³/h]	Type of coil	Differential pressure [bar]		Max pressure [bar]	Weight [g]
					AC	DC		
W_911200002	1/8"	1.5	0.06	3	0 to 10	0 to 10	11	100
W_911200003	1/8"	2	0.09	3	0 to 6	0 to 6	6.5	100
W_911200005	1/4"	2	0.11	2	0 to 13	0 to 13	14	240
W_911200006	1/4"	2.5	0.16	2	0 to 10	0 to 10	11	240

To complete the code enter: **0** for NBR gaskets **V** for FKM/FPM gaskets  
**E** for EPDM gaskets

## SOLENOID VALVES, SERIES EV-FLUID, SERVO-ASSISTED ACTION



TECHNICAL DATA		NBR	FPM/FKM	EPDM
Max operating frequency (with air)	Hz	2		
Power consumption		DC: 6.5 - 10 W / AC: 8 - 15 VA		
Voltage available		12 - 24VDC / 24 - 110 - 220 VAC 50/60 Hz		
Voltage tolerance	%	DC: ±10 / AC: -10 to +15		
Type of protection		IP 65 with connector		
Fluid temperature	°C	-10 to +90	-10 to +140	-10 to +140
Ambient temperature	°C	with coil C.I.F: -10 to +55; can with coil C.I.H: -10 to +80		
Maximum fluid viscosity		25 cSt (mm <sup>2</sup> /s)		
Pressure range, flow rate, weight		See dimensions and ordering codes		
Maximum coil nut torque	Nm	1.5		
Usable fluids / Materials compatibility		Valves that can be used with neutral or slightly aggressive liquid and gas fluids. (Refer to the tables of chemical compatibility of materials in contact with the fluid on <a href="http://www.metalwork.it">www.metalwork.it</a> or contact Metal Work technical service)		

### VERSION 2/2 NC, BRASS VALVE BODY

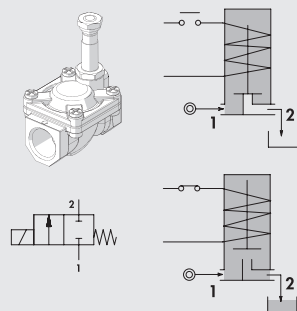

Code	Threaded port	Air hole Ø [mm]	Kv factor [m <sup>3</sup> /h]	Type of coil	Differential pressure [bar]		Max pressure * [bar]	Weight [g]
					AC	DC		
W 910200001	1/4"	10	1.5	3	0.15 to 15	0.15 to 15	25	180
W 910200002	3/8"	10	1.7	3	0.15 to 15	0.15 to 15	25	190
W 910200003	3/8"	12	2.2	3	0.15 to 15	0.15 to 15	25	370
W 910200004	1/2"	12	2.5	3	0.15 to 15	0.15 to 15	25	340
W 910200005	3/4"	18	5.5	3	0.15 to 13	0.15 to 13	25	600
W 910200006	1"	25	10.2	3	0.15 to 10	0.15 to 10	25	1000
W 910200007	1 1/4"	37	18	2	0.15 to 10	0.15 to 10	25	2880
W 910200008	1 1/2"	37	21	2	0.15 to 10	0.15 to 10	25	2730
W 910200009	2"	50	36	2	0.15 to 10	0.15 to 10	25	4180

To complete the code enter: **O** for NBR gaskets **V** for FKM/FPM gaskets \* The maximum allowable pressure for steam is 2.5 bar  
**E** for EPDM gaskets

### VERSION 2/2 NC, STAINLESS STEEL VALVE BODY, FKM/FPM GASKETS

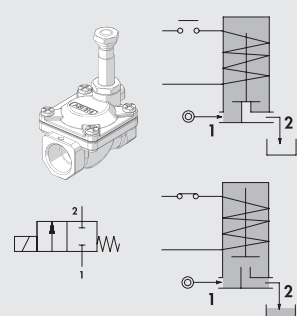

Code	Threaded port	Air hole Ø [mm]	Kv factor [m <sup>3</sup> /h]	Type of coil	Differential pressure [bar]		Max pressure * [bar]	Weight [g]
					AC	DC		
WV910400001	3/8"	12	2.2	3	0.15 to 15	0.15 to 15	25	250
WV910400002	1/2"	12	2.5	3	0.15 to 15	0.15 to 15	25	270
WV910400003	3/4"	18	5.5	3	0.15 to 13	0.15 to 13	25	500
WV910400004	1"	25	10.2	3	0.15 to 10	0.15 to 10	25	900

\* The maximum allowable pressure for steam is 2.5 bar

### VERSION 2/2 NO, BRASS VALVE BODY

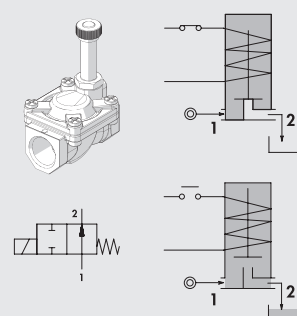

Code	Threaded port	Air hole Ø [mm]	Kv factor [m <sup>3</sup> /h]	Type of coil	Differential pressure [bar]		Max pressure * [bar]	Weight [g]
					AC	DC		
W 910900001	1/4"	10	1.5	3	0.15 to 15	0.15 to 15	25	180
W 910900003	3/8"	12	1.7	3	0.15 to 15	0.15 to 15	25	370
W 910900004	1/2"	12	2.5	3	0.15 to 15	0.15 to 15	25	340
W 910900005	3/4"	18	5.5	3	0.15 to 13	0.15 to 13	25	600
W 910900006	1"	25	10.2	3	0.15 to 10	0.15 to 10	25	1000

To complete the code enter: **O** for NBR gaskets **V** for FKM/FPM gaskets \* The maximum allowable pressure for steam is 2.5 bar  
**E** for EPDM gaskets

## SOLENOID VALVES, SERIES EV-FLUID, MIXED ACTION



TECHNICAL DATA		FPM/FKM
Max operating frequency (with air)	Hz	2
Power consumption		DC: 27 W / AC: 30 VA
Voltage available		12 - 24VDC / 24 - 110 - 220 VAC 50/60 Hz
Voltage tolerance	%	DC: ±10 / AC: -10 to +15
Type of protection		IP 65 with connector
Fluid temperature	°C	-10 to +90
Ambient temperature	°C	with coil C.I.H: -10 to +80
Maximum fluid viscosity		25 cSt (mm <sup>2</sup> /s)
Pressure range, flow rate, weight		See dimensions and ordering codes
Maximum coil nut torque	Nm	1.5
Usable fluids / Materials compatibility		Valves that can be used with neutral or slightly aggressive liquid and gas fluids. (Refer to the tables of chemical compatibility of materials in contact with the fluid on <a href="http://www.metalwork.it">www.metalwork.it</a> or contact Metal Work technical service)

### VERSION 2/2 NC, BRASS VALVE BODY, FKM/FPM GASKETS

Code	Threaded port	Air hole Ø [mm]	Kv factor [m <sup>3</sup> /h]	Type of coil	Differential pressure [bar]		Max pressure [bar]	Weight [g]
					AC	DC		
WV910600003	3/8"	12	2	5	0 to 12	0 to 10	25	400
WV910600004	1/2"	12	2.2	5	0 to 12	0 to 10	25	370
WV910600005	3/4"	18	4.5	5	0 to 9	-	25	610
WV910600006	1"	25	8.5	5	0 to 7	-	25	1020
WV910610005	3/4"	18	4.5	5	-	0 to 9	25	610
WV910610006	1"	25	8.5	5	-	0 to 8	25	1020

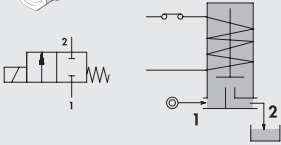

## COILS AND CONNECTORS FOR EV-FLUIDSERIES SOLENOID VALVES

### COILS SIDE 22 mm TYPE 3

- Voltage tolerance: -10% to +15% AC version / ±10% DC version
- Degree of protection: IP65 EN60529 with connector
- Duty Cycle: 100%
- Connector: DIN 43650 B

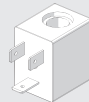

Code	Abbrev.	Nominal voltage	Absorption	Index of protection
W0911100001	Coil 22 Ø10 Type 3, 6.5W 12VDC	12VDC	6.5W	F
W0911100002	Coil 22 Ø10 Type 3, 6.5W 24VDC	24VDC	6.5W	F
W0911100003	Coil 22 Ø10 Type 3, 8VA 24V 50/60Hz	24V 50/60Hz	8VA	F
W0911100004	Coil 22 Ø10 Type 3, 8VA 110V 50/60Hz	110V 50/60Hz	8VA	F
W0911100005	Coil 22 Ø10 Type 3, 8VA 220V 50/60Hz	220V 50/60Hz	8VA	F

### COILS SIDE 30 MM TYPE 2

- Voltage tolerance: -10% to +15% AC version / ±10% DC version
- Degree of protection: IP65 EN60529 with connector
- Duty Cycle: 100%
- Connector: DIN 43650 B

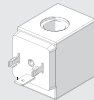

Code	Abbrev.	Nominal voltage	Absorption	Classe isolamento
W0911100011	Coil 30 Ø13 Type 2, 10W 12VDC	12VDC	10W	F
W0911100012	Coil 30 Ø13 Type 2, 10W 24VDC	24VDC	10W	F
W0911100013	Coil 30 Ø13 Type 2, 15VA 24V 50/60Hz	24V 50/60Hz	15VA	F
W0911100014	Coil 30 Ø13 Type 2, 15VA 110V 50/60Hz	110V 50/60Hz	15VA	F
W0911100015	Coil 30 Ø13 Type 2, 15VA 220V 50/60Hz	220V 50/60Hz	15VA	F

### CONNECTOR FOR COILS SIDE 22 MM FOR COIL TYPE 3

Code	Type	Colour	Ø Cable
W0970510011	Standard	Black	PG9
W0970510012	LED 24V	Transparent	PG9
W0970510013	LED 110V	Transparent	PG9
W0970510014	LED 220V	Transparent	PG9
W0970510015	LED + VDR 24V	Transparent	PG9
W0970510016	LED + VDR 110V	Transparent	PG9
W0970510017	LED + VDR 220V	Transparent	PG9

### COILS SIDE 30 MM TYPE 4

- Voltage tolerance: -10% to +15% AC version / ±10% DC version
- Degree of protection: IP65 EN60529 with connector
- Duty Cycle: 100%
- Connector: DIN 43650 B



Code	Abbrev.	Nominal voltage	Absorption	Index of protection
W0911100006	Coil 30 Ø10 Type 4, 5W 12VDC	12VDC	5W	F
W0911100007	Coil 30 Ø10 Type 4, 5W 24VDC	24VDC	5W	F
W0911100008	Coil 30 Ø10 Type 4, 11VA 24V 50/60Hz	24V 50/60Hz	11VA	F
W0911100009	Coil 30 Ø10 Type 4, 11VA 110V 50/60Hz	110V 50/60Hz	11VA	F
W0911100010	Coil 30 Ø10 Type 4, 11VA 220V 50/60Hz	220V 50/60Hz	11VA	F

### COILS SIDE 36 MM TYPE 5

- Voltage tolerance: -10% to +15% AC version / ±10% DC version
- Degree of protection: IP65 EN60529 with connector
- Duty Cycle: 100%
- Connector: DIN 43650 B

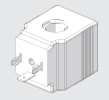

Code	Abbrev.	Nominal voltage	Absorption	Index of protection
W0911100016	Coil 36 Ø13 Type 5, 27W 12VDC	12VDC	27W	H
W0911100017	Coil 36 Ø13 Type 5, 27W 24VDC	24VDC	27W	H
W0911100018	Coil 36 Ø13 Type 5, 30VA 24V 50/60Hz	24V 50/60Hz	30VA	H
W0911100019	Coil 36 Ø13 Type 5, 30VA 110V 50/60Hz	110V 50/60Hz	30VA	H
W0911100020	Coil 36 Ø13 Type 5, 30VA 220V 50/60Hz	220V 50/60Hz	30VA	H

### CONNECTOR ON SIDE 30 MM FOR COILS TYPE 2, 4, 5

Code	Type	Colour	Ø Cable
W0970520033	Standard	Black	PG11
W0970520034	LED 24V	Transparent	PG11
W0970520035	LED 110V	Transparent	PG11
W0970520036	LED 220V	Transparent	PG11
W0970520037	LED + VDR 24V	Transparent	PG11
W0970520038	LED + VDR 110V	Transparent	PG11
W0970520039	LED + VDR 220V	Transparent	PG11

## ACTUATED VALVES SERIES RV-FLUID

### ACTUATED BALL VALVES SERIES RV-FLUID

TECHNICAL DATA VALVES		BRASS	STAINLESS STEEL
Max operating pressure *	bar MPa	40 4	63 6.3
Fluid temperature	psi	580	913.5
Ambient temperature	°C	-20 to +130	-25 to +180
Usable fluids / Materials compatibility	°C	-20 to +80	
Valves that can be used with neutral or slightly aggressive liquid and gas fluids. (Refer to the tables of chemical compatibility of materials in contact with the fluid on <a href="http://www.metalwork.it">www.metalwork.it</a> or contact Metal Work technical service)			
Nominal diameter (DN)	mm	8 to 80	8 to 80
Mounting position		Any, except that with actuator downwards, which is not recommended	
Note		High- and low-temperature versions on request	
<b>ROTARY ACTUATOR</b>			
Operating pressure	bar MPa	6 to 10 0.6 to 1	
Ambient temperature	psi	87 to 145	
Fluid	°C	-20 to +80	
Filtered lubricated or unlubricated air. Lubrication, if used, must be continuous			

\* The maximum working pressure varies with temperature. See the "Max. pressure/temperature chart" in the general catalogue.

#### 2-WAYS BRASS ACTUATED BALL VALVES



Code	DN (nominal diameter)	Threaded port	Kv factor [m³/h]	Max pressure * [bar]	Rotary actuator bore	Weight [g]
<b>SINGLE-ACTING</b>						
W0900300090	10	1/4"	5.9	40	42	1342
W0900300091	10	3/8"	9.4	40	42	1320
W0900300092	15	1/2"	17	40	42	1147
W0900300093	20	3/4"	41	40	50	1515
W0900300094	25	1"	70	40	63	2338
W0900300095	32	1 1/4"	121	40	63	2670
W0900300096	40	1 1/2"	200	25	75	2959
W0900300097	50	2"	292	25	75	5360
W0900300098	65	2 1/2"	535	25	85	8436
W0900300099	80	3"	850	25	85	10750
<b>DOUBLE-ACTING</b>						
W0900300101	10	1/4"	5.9	40	32	832
W0900300102	10	3/8"	9.4	40	32	810
W0900300103	15	1/2"	17	40	32	637
W0900300104	20	3/4"	41	40	32	735
W0900300105	25	1"	70	40	42	1408
W0900300106	32	1 1/4"	121	40	50	1940
W0900300107	40	1 1/2"	200	25	63	2759
W0900300108	50	2"	292	25	63	3590
W0900300109	65	2 1/2"	535	25	63	5206
W0900300110	80	3"	850	25	63	8820

\* The maximum operating pressure varies with the temperature. See the "Max. pressure/temperature chart" in the general catalogue.

#### 3-WAYS BRASS ACTUATED BALL VALVES

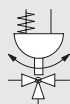

Code for L-shaped ball hole	Code for T-shaped ball hole	DN (diámetro nominal)	Threaded port	Kv factor [m³/h]	Max pressure * [bar]	Rotary actuator bore	Weight [g]
<b>SINGLE-ACTING</b>							
W0900300141	W0900300151	8	1/4"	5.9	40	42	1625
W0900300142	W0900300152	10	3/8"	9.4	40	42	1597
W0900300143	W0900300153	15	1/2"	17	40	50	1741
W0900300144	W0900300154	20	3/4"	41	40	63	2614
W0900300145	W0900300155	25	1"	70	40	63	3117
W0900300146	W0900300156	32	1 1/4"	121	40	75	6465
W0900300147	W0900300157	40	1 1/2"	200	25	75	6737
W0900300148	W0900300158	50	2"	292	25	085	9586
<b>DOUBLE-ACTING</b>							
W0900300121	W0900300131	8	1/4"	55	40	32	1115
W0900300122	W0900300132	10	3/8"	55	40	32	1087
W0900300123	W0900300133	15	1/2"	55	40	32	961
W0900300124	W0900300134	20	3/4"	71.5	40	50	1884
W0900300125	W0900300135	25	1"	82	40	50	2387
W0900300126	W0900300136	32	1 1/4"	92.5	40	50	4165
W0900300127	W0900300137	40	1 1/2"	105.5	25	63	4967
W0900300128	W0900300138	50	2"	116.5	25	63	6356

\* The maximum operating pressure varies with the temperature. See the "Max. pressure/temperature chart" in the general catalogue.

### 2-WAYS STAINLESS STEEL ACTUATED BALL VALVES



Code	DN (nominal diameter)	Threaded port	Kv factor [m <sup>3</sup> /h]	Max pressure * [bar]	Rotary actuator bore	Weight [g]
<b>SINGLE-ACTING</b>						
W0900300009	10	1/4"	5.6	63	42	1300
W0900300010	10	3/8"	6.8	63	42	1280
W0900300011	15	1/2"	9.6	63	42	1300
W0900300012	20	3/4"	17.9	63	50	1690
W0900300013	25	1"	30	63	63	2540
W0900300014	32	1 1/4"	49	63	63	2980
W0900300015	40	1 1/2"	68	63	75	5310
W0900300016	50	2"	126	63	75	6270
<b>DOUBLE-ACTING</b>						
W0900300001	10	1/4"	5.6	63	32	790
W0900300002	10	3/8"	6.8	63	32	770
W0900300003	15	1/2"	9.6	63	32	790
W0900300004	20	3/4"	17.9	63	32	910
W0900300005	25	1"	30	63	42	1610
W0900300006	32	1 1/4"	49	63	50	2250
W0900300007	40	1 1/2"	68	63	63	3540
W0900300008	50	2"	126	63	75	5800

\* The maximum operating pressure varies with the temperature. See the "Max. pressure/temperature chart" in the general catalogue.

### 3-WAYS STAINLESS STEEL ACTUATED BALL VALVES

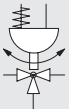

Code for L-shaped ball hole	Code for T-shaped ball hole	DN (diámetro nominal)	Threaded port	Kv factor [m <sup>3</sup> /h]	Max pressure * [bar]	Rotary actuator bore	Weight [g]
<b>SINGLE-ACTING</b>							
W0900300161	W0900300171	8	1/4"	3.2	63	63	2500
W0900300162	W0900300172	10	3/8"	3.4	63	63	2470
W0900300163	W0900300173	15	1/2"	3.8	63	63	2430
W0900300164	W0900300174	20	3/4"	7.7	63	63	2740
W0900300165	W0900300175	25	1"	13.7	63	75	4760
W0900300166	W0900300176	32	1 1/4"	20.5	63	75	6280
W0900300167	W0900300177	40	1 1/2"	31.5	63	100	10480
W0900300168	W0900300178	50	2"	58	63	115	16610
<b>DOUBLE-ACTING</b>							
W0900300080	W0900300112	8	1/4"	3.2	63	42	1570
W0900300081	W0900300113	10	3/8"	3.4	63	42	1540
W0900300082	W0900300114	15	1/2"	3.8	63	42	1500
W0900300083	W0900300115	20	3/4"	7.7	63	42	1810
W0900300084	W0900300116	25	1"	13.7	63	50	2460
W0900300085	W0900300117	32	1 1/4"	20.5	63	63	4510
W0900300086	W0900300118	40	1 1/2"	31.5	63	75	6560
W0900300087	W0900300119	50	2"	58	63	75	9210

\* The maximum operating pressure varies with the temperature. See the "Max. pressure/temperature chart" in the general catalogue.

### 3-PIECE STAINLESS STEEL ACTUATED BALL VALVES



Code	DN (nominal diameter)	Threaded port	Kv factor [m <sup>3</sup> /h]	Max pressure * [bar]	Rotary actuator bore	Weight [g]
<b>SINGLE-ACTING</b>						
W0900300201	10	1/4"	5.6	63	50	1610
W0900300202	10	3/8"	6.8	63	50	1600
W0900300203	15	1/2"	9.6	63	50	1650
W0900300204	20	3/4"	17.9	63	63	2660
W0900300205	25	1"	30	63	75	4590
W0900300206	32	1 1/4"	49	63	75	5250
W0900300207	40	1 1/2"	68	63	75	6150
W0900300208	50	2"	126	63	85	8390
W0900300209	65	2 1/2"	226	63	100	14020
W0900300210	80	3"	355	63	145	22400
<b>DOUBLE-ACTING</b>						
W0900300181	10	1/4"	5.6	63	32	830
W0900300182	10	3/8"	6.8	63	32	820
W0900300183	15	1/2"	9.6	63	32	870
W0900300184	20	3/4"	17.9	63	42	1730
W0900300185	25	1"	30	63	50	2290
W0900300186	32	1 1/4"	49	63	63	3480
W0900300187	40	1 1/2"	68	63	63	4380
W0900300188	50	2"	126	63	75	6460
W0900300189	65	2 1/2"	226	63	75	10100
W0900300190	80	3"	355	63	100	17900

\* The maximum operating pressure varies with the temperature. See the "Max. pressure/temperature chart" in the general catalogue.



### WAFER STAINLESS STEEL ACTUATED BALL VALVES



Code	DN (nominal diameter)	Threaded port	Kv factor [m³/h]	Max pressure * [bar]	Rotary actuator bore	Weight [g]
<b>SINGLE-ACTING</b>						
W0900300031	15	1/2"	22.3	40	63	2910
W0900300032	20	3/4"	47.7	40	63	3280
W0900300033	25	1"	83.5	40	75	5300
W0900300034	32	1 1/4"	150.4	40	75	6470
W0900300035	40	1 1/2"	255	40	75	7570
W0900300036	50	2"	435	40	85	10200
<b>DOUBLE-ACTING</b>						
W0900300021	15	1/2"	22.3	40	42	1980
W0900300022	20	3/4"	47.7	40	42	2350
W0900300023	25	1"	83.5	40	50	3000
W0900300024	32	1 1/4"	150.4	40	63	4700
W0900300025	40	1 1/2"	255	40	63	5800
W0900300026	50	2"	435	40	63	6970

\* The maximum operating pressure varies with the temperature. See the "Max. pressure/temperature chart" in the general catalogue.

## ACTUATED BUTTERFLY VALVES SERIES RV-FLUID

### TECHNICAL DATA VALVES

Max operating pressure *	bar	16
	MPa	1.6
	psi	232
Fluid temperature	°C	-10 to +120
Ambient temperature	°C	-20 to +80
Usable fluids / Materials compatibility	Valves that can be used with neutral or slightly aggressive liquid and gas fluids. (Refer to the tables of chemical compatibility of materials in contact with the fluid on www.metalwork.it or contact Metal Work technical service)	
Nominal diameter (DN)	mm	50 to 200
Mounting position	Any, except that with actuator downwards, which is not recommended	
Note	High- and low-temperature versions on request	
<b>ROTARY ACTUATOR</b>		
Operating pressure	bar	16
	MPa	1.6
	psi	232
Ambient temperature	°C	-20 to +80
Fluid	Filtered lubricated or unlubricated air. Lubrication, if used, must be continuous	

\* The maximum working pressure varies with temperature. See the "Max. pressure/temperature chart" in the general catalogue.

### ACTUATED BUTTERFLY VALVES



Code	DN (nominal diameter)	Threaded port	Kv factor [m³/h]	Max pressure * [bar]	Rotary actuator bore	Weight [g]
<b>SINGLE-ACTING</b>						
W0900300051	50	2"	99	16	75	5470
W0900300052	65	2 1/2"	108	16	75	5770
W0900300053	80	3"	261	16	85	8030
W0900300054	100	4"	518	16	100	11120
W0900300055	125	5"	883	16	115	16600
W0900300056	150	6"	1364	16	115	18100
W0900300057	200	8"	2716	16	145	34000
<b>DOUBLE-ACTING</b>						
W0900300041	50	2"	99	16	63	3700
W0900300042	65	2 1/2"	108	16	63	4000
W0900300043	80	3"	261	16	63	4800
W0900300044	100	4"	518	16	75	7200
W0900300045	125	5"	883	16	75	9200
W0900300046	150	6"	1364	16	85	12000
W0900300047	200	8"	2716	16	115	24200

\* The maximum operating pressure varies with the temperature. See the "Max. pressure/temperature chart".

## ACCESSORIES ACTUATED VALVES SERIES RV-FLUID

### SWITCH BOX WITH ELECTROMECHANICAL MICROSWITCHES FOR ACTUATOR

Code	Description
W0900300915	Switch box with electromechanical microswitches for actuator size 32
W0900300916	Switch box with electromechanical microswitches for actuator size 42 - 63
W0900300917	Switch box with electromechanical microswitches for actuator size 115 - 145
W0900300919	Switch box with electromechanical microswitches for actuator size da 75 - 100

### POSITION INDICATOR FOR ACTUATOR

Code	Description
W0900300930	Position indicator for actuator size 32 - 63
W0900300931	Position indicator for actuator size 75 - 100
W0900300933	Position indicator for actuator size 32 - 100 (only without switch box)
W0900300932	Position indicator for actuator size 115 - 145

### CONTROL VALVES WITH NAMUR INTERFACE

See page 96



GENERAL TECHNICAL DATA		SIZE 1			SIZE 2			
Threaded port		1/8"	1/4"	3/8"	3/8"	1/2"	3/4"	1"
Max. input pressure	bar	15			13			
	MPa	1.5			1.3			
	psi	217			188			
Flow rate		See catalogue of the various elements						
Min/max temperature at 10 bar; 1 MPa; 145 psi	°C	from -10 to +50			from -10 to +50			
Padlockable knob		The knobs of the regulators, filter regulators and standard sectioning valves can all be padlocked						
Fluid		Compressed air or other inert gases						
Mounting position		See catalogue of the various elements						
Direction of flow		Flow options right to left or vice versa						
Additional air take-off, for pressure gauges or fittings		1/8", front and rear, on all modules			1/4", front and rear, on all modules			
Wall fixing screws		No. 2 M4 screws			No. 2 M5 screws			
Certification for potentially explosive atmosphere according to 94/9/CE		Ex II 3 GD c T5 T 100°C -20°C < Ta < 50°C						

#### KEY TO CODES SINGLE ELEMENT

56 SYNTESI	1 SIZE	1 THREADED INPUT CONNECTION	F 10 ELEMENT	1 THREADED OUTPUT CONNECTION
56 Syntesi	1 Size 1	0 Without bushing 2 1/4" port	Varies from element to element	0 Without bushing 2 1/4" port
5X Syntesi anti-corrosion	2 Size 2	1 1/8" port 3 3/8" port		1 1/8" port 3 3/8" port
		0 Without bushing 5 3/4" port		0 Without bushing 5 3/4" port
		3 3/8" port 6 1" port		3 3/8" port 6 1" port
		4 1/2" port		4 1/2" port

#### KEY TO CODES UNIT COMPOSED OF TWO OR THREE ELEMENTS

56 SYNTESI	1 SIZE	1 THREADED INPUT CONNECTION	V 10 ELEMENT 1	B 24 ELEMENT 2	L 10 ELEMENT 3	1 THREADED OUTPUT CONNECTION
56 Syntesi	1 Size 1	1 1/8" port 3 3/8" port	Varies from element to element	Varies from element to element	Varies from element to element	1 1/8" port 3 3/8" port
5X Syntesi anti-corrosion	2 Size 2	2 1/4" port 5 3/4" port				2 1/4" port 5 3/4" port
		3 3/8" port 6 1" port				3 3/8" port 6 1" port
		4 1/2" port				4 1/2" port

#### ELEMENTS

<b>FILTER</b>	<b>FILTER-REGULATOR</b>	<b>B 16</b> FR 5µm RMSA 0-12 bar	<b>AIR TAKE-OFF</b>
<b>F10</b> FIL 5µm RMSA	● <b>B10</b> FR 5µm RMSA 0-2 bar	<b>B26</b> FR 20µm RMSA 0-12 bar	■ <b>P10</b> PA 2-way
<b>F20</b> FIL 20µm RMSA	● <b>B20</b> FR 20µm RMSA 0-2 bar	<b>B36</b> FR 50µm RMSA 0-12 bar	<b>P20</b> PA 4-way
<b>F30</b> FIL 50µm RMSA	● <b>B30</b> FR 50µm RMSA 0-2 bar	<b>B46</b> FR 5µm RA 0-12 bar	■ Version usable only between 2 elements.
<b>F40</b> FIL 5µm RA	● <b>B40</b> FR 5µm RA 0-2 bar	<b>B56</b> FR 20µm RA 0-12 bar	● Not available in the anti-corrosion version.
<b>F50</b> FIL 20µm RA	● <b>B50</b> FR 20µm RA 0-2 bar	<b>B66</b> FR 50µm RA 0-12 bar	+ Anti-corrosion version available only in size 1.
<b>F60</b> FIL 50µm RA	● <b>B60</b> FR 50µm RA 0-2 bar	<b>B17</b> FR 5µm SAC 0-12 bar	* Only for size 2
<b>F11</b> FIL 5µm SAC	● <b>B11</b> FR 5µm SAC 0-2 bar	<b>B27</b> FR 20µm SAC 0-12 bar	RMSA: drain with manual condensate discharge and automatic discharge at zero pressure.
<b>F21</b> FIL 20µm SAC	● <b>B21</b> FR 20µm SAC 0-2 bar	<b>B37</b> FR 50µm SAC 0-12 bar	RA: automatic drain with condensate discharge, independent of pressure and flow rate. Version conveys the draining by inserting the pipe having internal diameter 6 mm in the lower port.
<b>F31</b> FIL 50µm SAC	● <b>B31</b> FR 50µm SAC 0-2 bar		SAC: automatic drain with condensate discharge.
<b>DEPURATOR</b>	+ <b>B12</b> FR 5µm RMSA 0-4 bar	<b>LUBRICATOR</b>	<b>Operates by depression - requires variable air take-offs.</b>
<b>D10</b> DEP RMSA	+ <b>B22</b> FR 20µm RMSA 0-4 bar	<b>L10</b> LUB	
<b>D11</b> DEP SAC	+ <b>B32</b> FR 50µm RMSA 0-4 bar	<b>SHUT-OFF VALVE</b>	
<b>ACTIVE CARBON FILTER</b>	+ <b>B42</b> FR 5µm RA 0-4 bar	<b>V10</b> V3V Manual with Ø 3.5 holes for padlocks	
<b>C10</b> AC RMSA	+ <b>B52</b> FR 20µm RA 0-4 bar	<b>V11</b> V3V Manual with Ø 7 holes for padlocks	
<b>REGULATOR</b>	+ <b>B62</b> FR 50µm RA 0-4 bar	● <b>V20</b> V3V Pneumatic	
● <b>R10</b> REG 0-2 bar	+ <b>B13</b> FR 5µm SAC 0-4 bar	● <b>V30</b> V3V Solenoid pilot-assisted	
+ <b>R12</b> REG 0-4 bar	+ <b>B23</b> FR 20µm SAC 0-4 bar	● <b>V70</b> V3V Solenoid	
<b>R14</b> REG 0-8 bar	+ <b>B33</b> FR 50µm SAC 0-4 bar	● <b>PROGRESSIVE STARTER</b>	
<b>R16</b> REG 0-12 bar		<b>A70</b> APR Solenoid	
<b>IN-SERIES REGULATOR</b>	<b>B14</b> FR 5µm RMSA 0-8 bar	* <b>A71</b> APR Cnomo solenoid	
● <b>R20</b> In-series REG 0-2 bar	<b>B24</b> FR 20µm RMSA 0-8 bar	● <b>PRESSURE SWITCHES</b>	
+ <b>R22</b> In-series REG 0-4 bar	<b>B34</b> FR 50µm RMSA 0-8 bar	<b>S10</b> Pressure switch, 2 m cable	
<b>R24</b> In-series REG 0-8 bar	<b>B44</b> FR 5µm RA 0-8 bar	<b>S20</b> Pressure switch, 300 mm cable with M8 connector	
<b>R26</b> In-series REG 0-12 bar	<b>B54</b> FR 20µm RA 0-8 bar		
<b>PILOT OPERATED REGULATOR</b>	<b>B64</b> FR 50µm RA 0-8 bar		
<b>R00</b> Pilot operated regulator	<b>B15</b> FR 5µm SAC 0-8 bar		
	<b>B25</b> FR 20µm SAC 0-8 bar		
	<b>B35</b> FR 50µm SAC 0-8 bar		

**NOTE**  
Anti-corrosion version  
5X - - - - -  
**Example**  
5X11F101 FIL SY1 1/8 5 RMSA anti-corrosion

UNITS

SYNTESI

**FILTER**



TECHNICAL DATA	FIL SY 1				FIL SY 2			
	1/8"	1/4"	3/8"	3/8"	1/2"	3/4"	1"	
Threaded port								
Degree of filtration	5 (yellow) - output air purity class ISO8573-1: 3.7.4 20 (white) - output air purity class ISO8573-1: 4.7.4 50 (blue) - output air purity class ISO8573-1: 5.7.4							
Max. input pressure	bar 15 MPa 1.5 psi 217				bar 13 MPa 1.3 psi 188			
Flow rate at 6.3 bar (0.63 MPa; 91 psi) ΔP 0.5 bar (0.05 MPa; 7 psi)	Nl/min 900 scfm 32	Nl/min 1200 scfm 42	Nl/min 1300 scfm 46	Nl/min 3400 scfm 120	Nl/min 3800 scfm 135	Nl/min 3800 scfm 135		
Flow rate at 6.3 bar (0.63 MPa; 91 psi) ΔP 1 bar (0.1 MPa; 14 psi)	Nl/min 1300 scfm 46	Nl/min 1650 scfm 58	Nl/min 1750 scfm 62	Nl/min 4500 scfm 159	Nl/min 5200 scfm 184	Nl/min 5200 scfm 184		
Min/max temperature at 10 bar; 1 MPa; 145 psi	°C From -10 to +50				°C From -10 to +50			
Weight	g 178		g 173		g 164		g 488	
Condensate drain	RMSA: drain with manual condensate discharge and automatic discharge at zero pressure RA: automatic drain with condensate discharge, independent of pressure and flow rate Version conveys the draining by inserting the pipe having internal diameter 6 mm in the lower port. SAC: automatic drain with condensate discharge. <b>Operates by depression – requires variable air take-offs.</b> Note: <b>the maximum input pressure for the RA version must not exceed 10 bar</b> Compressed air or other inert gases							
Fluid								
Condensate bowl capacity	cm³ 30				cm³ 70			
Mounting position	Vertical				Vertical			
Port for additional air take-off	1/8", front and rear				1/4", front and rear			
Additional air take-off flow rate at 6.3 bar (0.63 MPa; 91 psi) ΔP 1 bar (0.1 MPa; 14 psi)	Nl/min 500		Nl/min 18		Nl/min 1500		Nl/min 53	
Wall fixing screws	No. 2 M4 screws				No. 2 M5 screws			

**DEPURATOR**



TECHNICAL DATA	DEP SY 1				DEP SY 2			
	1/8"	1/4"	3/8"	3/8"	1/2"	3/4"	1"	
Threaded port								
Degree of filtration	0.01 - output air purity class ISO8573-1: 1.7.2							
Max. input pressure	bar 15 MPa 1.5 psi 217				bar 13 MPa 1.3 psi 188			
Suggested flow rate at 6.3 bar (0.63 MPa; 91 psi)	Nl/min 460 scfm 9	Nl/min 620 scfm 22	N.B.: flow rates higher than the recommended value reduces purification efficiency From -10 to +50		Nl/min 620 scfm 22	Nl/min 37 scfm 13	From -10 to +50	
Min/max temperature at 10 bar; 1 MPa; 145 psi	°C 194		°C 189		°C 180		°C 483	
Weight	g 194		g 189		g 180		g 456	
Condensate drain	RMSA: drain with manual condensate discharge and automatic discharge at zero pressure SAC: automatic drain with condensate discharge. <b>Operates by depression – requires variable air take-offs.</b> Compressed air or other inert gases							
Fluid								
Bowl capacity	cm³ 15				cm³ 40			
Mounting position	Vertical				Vertical			
Port for additional air take-off (not purified air)	1/8", front and rear				1/4", front and rear			
Additional air take-off flow rate at 6.3 bar (0.63 MPa; 91 psi) ΔP 1 bar (0.1 MPa; 14 psi)	Nl/min 500		Nl/min 18		Nl/min 1500		Nl/min 53	
Wall fixing screws	No. 2 M4 screws				No. 2 M5 screws			
Notes on use	It is advisable to mount a 5 µm filter upstream of the purifier to retain solid particles							

## ACTIVE CARBON FILTER



TECHNICAL DATA	FIL CA SY 1			FIL CA SY 2			
	1/8"	1/4"	3/8"	3/8"	1/2"	3/4"	1"
Threaded port	0.003 - output air purity class ISO8573-1: 1.7.1						
Residual oil at 20°C *	mg/m <sup>3</sup>			4000			
Duration of cartridge *	hours			13			
Max. inlet pressure	bar			1.3			
	MPa			1.5			
	psi			217			
Suggested flow rate at 6.3 bar (0.63 MPa; 91 psi)	NI/min			350			
	scfm			12			
Min/max temperature at 10 bar; 1 MPa; 145 psi	°C			N.B.: flow rates higher than the recommended value reduces purification efficiency			
Weight	195	190	181	483	456	452	440
Condensate drain	RMSA: drain with manual condensate discharge and automatic discharge at zero pressure						
Fluid	0.01 µm filtered and deperated air						
Mounting position	In any position			In any position			
Additional air take-off port (unfiltered air from cartridge CA)	1/8", front and rear			1/4", front and rear			
Additional air take-off flow rate at 6.3 bar	NI/min			500			
(0.63 MPa; 91 psi) ΔP 1 bar (0.1 MPa; 14 psi)	scfm			18			
Wall fixing screws	No. 2 M4 screws			No. 2 M5 screws			
Notes on use	Upstream it's necessary to mount a coalescence filter deperator of 0.01 µm.						
* if the load loss of 75 mbar is not exceeded							

UNITS

## REGULATOR



TECHNICAL DATA	REG SY 1			REG SY 2			
	1/8"	1/4"	3/8"	3/8"	1/2"	3/4"	1"
Threaded port	Included						
Max. inlet pressure	bar			13			
	MPa			1.5			
	psi			217			
Flow rate at 6.3 bar (0.63 MPa; 91 psi) ΔP 0.5 bar (0.05 MPa; 7 psi)	570	1600	2900	3000	4300	4700	
(inlet pressure 10 bar)	20	57	103	106	152	166	
Flow rate at 6.3 bar (0.63 MPa; 91 psi) ΔP 1 bar (0.1 MPa; 14 psi)	1200	2800	3350	5300	7400	7600	
(inlet pressure 10 bar)	42	99	119	188	261	267	
Relief valve flow rate at 6.3 bar (0.63 MPa; 91 psi)	NI/min			100			
	scfm			2.5			
Min/max temperature at 10 bar; 1 MPa; 145 psi	°C			From -10 to +50			
Full outflow with zero inlet pressure	Included						
Padlockable knob	Included						
Upstream pressure compensation	Included, via balanced valve						
Weight	193	188	179	546	519	515	503
Fluid	Compressed air or other inert gases						
Mounting position	In any position			In any position			
Additional air take-off, for pressure gauges or fittings	1/8", front and rear			1/4", front and rear			
Additional air take-off flow rate at 6.3 bar	NI/min			500			
(0.63 MPa; 91 psi) ΔP 1 bar (0.1 MPa; 14 psi)	scfm			18			
Wall fixing screws	No. 2 M4 screws			No. 2 M5 screws			
Notes on use	The pressure must always be set upwards. For increased sensitivity, use a pressure regulator with a rated pressure as close as possible to the required value. On request version without overpressure exhaust						

SYNTESI

**IN-SERIES REGULATOR**



TECHNICAL DATA	IN-SERIES REGULATOR SY1			IN-SERIES REGULATOR SY2				
	1/8"	1/4"	3/8"	3/8"	1/2"	3/4"	1"	
Threaded inlet port, through								
Utility threaded port		1/8"				1/4"		
Max. input pressure		bar 15 MPa 1.5 psi 217				13 1.3 188		
Flow rate at 6.3 bar (0.63 MPa; 91 psi) ΔP 0.5 bar (0.05 MPa; 7 psi)	Nl/min scfm	330 12				540 19		
Flow rate at 6.3 bar (0.63 MPa; 91 psi) ΔP 1 bar (0.1 MPa; 14 psi)	Nl/min scfm	500 18				1000 35		
Relief valve flow rate at 6.3 bar (0.63 MPa; 91 psi)	Nl/min scfm	70 2.5				100 3.5		
Min/max temperature at 10 bar; 1 MPa; 145 psi		From -10 to +50			From -10 to +50			
Full outflow with zero inlet pressure					Included			
Padlockable knob					Included			
Upstream pressure compensation					Included, via balanced valve			
Weight	g	193	188	179	546	519	515	503
Fluid					Compressed air or other inert gases			
Mounting position					In any position			
Wall fixing screws		No. 2 M4 screws			No. 2 M5 screws			
Notes on use		The pressure must always be set upwards. For increased sensitivity, use a pressure regulator with a rated pressure as close as possible to the required value. On request version without overpressure exhaust						

**PILOT OPERATED REGULATOR**



TECHNICAL DATA	REG SY1			REG SY2				
	1/8"	1/4"	3/8"	3/8"	1/2"	3/4"	1"	
Threaded port								
Max. inlet pressure		bar 15 MPa 1.5 psi 217				13 1.3 188		
Flow rate at 6.3 bar (0.63 MPa; 91 psi) ΔP 0.5 bar (0.05 MPa; 7 psi)	Nl/min scfm	900 32	1700 60	3300 116	5500 194	5500 194	7300 258	
Flow rate at 6.3 bar (0.63 MPa; 91 psi) ΔP 1 bar (0.1 MPa; 14 psi)	Nl/min scfm	1000 53	2800 99	3550 120	6800 240	6800 240	7700 272	
Relief valve flow rate at 6.3 bar (0.63 MPa; 91 psi)	Nl/min scfm	70 2.5				100 3.5		
Min/max temperature at 10 bar; 1 MPa; 145 psi		From -10 to +50			From -10 to +50			
Full outflow with zero inlet pressure					Included			
Upstream pressure compensation					Included, via balanced valve			
Weight	g	149	144	135	456	429	425	413
Fluid					Compressed air or other inert gases			
Mounting position					In any position			
Additional air take-off, for pressure gauges or fittings		1/8", front and rear			1/4", front and rear			
Additional air take-off flow rate at 6.3 bar (0.63 MPa; 91 psi) ΔP 1 bar (0.1 MPa; 14 psi)		500			1400			
Wall fixing screws		18			50			
Notes on use		No. 2 M4 screws			No. 2 M5 screws			
		The pressure must always be set upwards.						

## FILTER-REGULATOR



TECHNICAL DATA	FR SY 1				FR SY 2			
	1/8"	1/4"	3/8"	3/8"	1/2"	3/4"	1"	
Threaded port								
Degree of filtration	5 (yellow) - output air purity class ISO8573-1: 3.7.4 20 (white) - output air purity class ISO8573-1: 4.7.4 50 (blue) - output air purity class ISO8573-1: 5.7.4							
Max. inlet pressure	bar			bar				
	MPa			MPa				
	psi			psi				
Flow rate at 6.3 bar (0.63 MPa; 91 psi) ΔP 0.5 bar (0.05 MPa; 7 psi)	Nl/min	500	800	2200	3200	4300	5200	
(inlet pressure 10 bar)	scfm	18	28	78	113	152	184	
Flow rate at 6.3 bar (0.63 MPa; 91 psi) ΔP 1 bar (0.1 MPa; 14 psi)	Nl/min	1300	2000	3000	5800	7200	7400	
(inlet pressure 10 bar)	scfm	46	71	106	205	255	262	
Relief valve flow rate at 6.3 bar (0.63 MPa; 91 psi)	Nl/min	70			100			
	scfm	2.5			3.5			
Min/max temperature at 10 bar; 1 MPa; 145 psi	°C				°C			
Full outflow with zero inlet pressure	Included							
Padlockable knob	Included							
Upstream pressure compensation	Included, via balanced valve							
Weight	g	244	239	230	623	596	592	
Fluid	Compressed air or other inert gases							
Mounting position	Vertical							
Additional air take-off, for pressure gauges or fittings	1/8", front and rear			1/4", front and rear				
Additional air take-off flow rate at 6.3 bar (0.63 MPa; 91 psi) ΔP 1 bar (0.1 MPa; 14 psi)	Nl/min	500			1400			
	scfm	18			50			
Bowl capacity	cm <sup>3</sup>	30			70			
Condensate drain	RMSA: drain with manual condensate discharge and automatic discharge at zero pressure RA: automatic drain with condensate discharge, independent of pressure and flow rate Version conveys the draining by inserting the pipe having internal diameter 6 mm in the lower port. SAC: automatic drain with condensate discharge. <b>Operates by depression – requires variable air take-offs.</b> Note: <b>the maximum input pressure for the RA version must not exceed 10 bar</b> No. 2 M4 screws   No. 2 M5 screws							
Wall fixing screws	No. 2 M4 screws			No. 2 M5 screws				
Notes on use	The pressure must always be set upwards. For increased sensitivity, use a pressure regulator with a rated pressure as close as possible to the required value. On request version without overpressure exhaust.							

UNITS

## LUBRICATOR



TECHNICAL DATA	LUB SY 1				LUB SY 2			
	1/8"	1/4"	3/8"	3/8"	1/2"	3/4"	1"	
Threaded port								
Type of lubrication	Oil mist							
Version	Manual filling from the top							
Max. input pressure	bar			bar				
	MPa			MPa				
	psi			psi				
Flow rate at 6.3 bar (0.63 MPa; 91 psi) ΔP 0.5 bar (0.05 MPa; 7 psi)	Nl/min	1300	1700	2200	2300	3900	3900	
(inlet pressure 10 bar)	scfm	46	60	78	81	138	138	
Flow rate at 6.3 bar (0.63 MPa; 91 psi) ΔP 1 bar (0.1 MPa; 14 psi)	Nl/min	1600	3000	3650	3650	6100	6100	
(inlet pressure 10 bar)	scfm	57	106	129	129	216	216	
Min/max temperature at 10 bar; 1 MPa; 145 psi	°C				°C			
Weight	g	185	180	171	480	453	449	
Fluid	Compressed air or other inert gases							
Quantity of filled oil	cm <sup>3</sup>	60			130			
Mounting position	Vertical			Vertical				
Port for additional air take-off	1/8", front and rear, lubricated air			1/4", front and rear, lubricated air				
Additional air take-off flow rate at 6.3 bar (0.63 MPa; 91 psi) ΔP 1 bar (0.1 MPa; 14 psi)	Nl/min	450			800			
	scfm	16			53			
Wall fixing screws	No. 2 M4 screws			No. 2 M5 screws				
Recommended oils	ISO and UNI FD22 (Energol HPL; Spinesso; Mobil DTE; Tellus oil)							
Notes on use	Install the lubricator as close as possible to the point of use. Fill the lubricator bowl with oil before pressurizing the system. Do not use cleaning oils, brake fluid oils or solvents in general. For the best lubrication results, set the drip rate to one drop for 300-600 Nl.							

SYNTESI



**SHUT-OFF VALVE**



TECHNICAL DATA	V3V SY 1			V3V SY 2			
	1/8"	1/4"	3/8"	3/8"	1/2"	3/4"	1"
Threaded port	1/8"			1/4"			
Threaded discharge port	1/8"			1/4"			
Type of control	Manual - pneumatic - Elpn - Elpn pilot-assisted			Manual - Pneumatic - Cnomo elpn - Cnomo elpn pilot-assisted			
Max inlet pressure for pneumatic and solenoid pilot-assisted versions	bar 15 MPa 1.5 psi 217			bar 13 MPa 1.3 psi 188			
Inlet pressure for solenoid version	bar 3 - 10 MPa 0.3 - 1 psi 43 - 145			bar 3 - 10 MPa 0.3 - 1 psi 43 - 145			
Pilot pressure for pneumatic and solenoid pilot-assisted versions	bar 3 - 10 MPa 0.3 - 1 psi 43 - 145			bar 3 - 10 MPa 0.3 - 1 psi 43 - 145			
Flow rate at 6.3 bar (0.63 MPa; 91 psi) ΔP 0.5 bar (0.05 MPa; 7 psi)	Nl/min 800	Nl/min 1000	Nl/min 1100	Nl/min 2800	Nl/min 3000	Nl/min 3000	Nl/min 3000
Flow rate at 6.3 bar (0.63 MPa; 91 psi) ΔP 1 bar (0.1 MPa; 14 psi)	Nl/min 1100	Nl/min 1500	Nl/min 1600	Nl/min 3600	Nl/min 4000	Nl/min 4000	Nl/min 4000
Exhaust flow rate at 6.3 bar (0.63 MPa; 91 psi)	Nl/min 39	Nl/min 53	Nl/min 57	Nl/min 127	Nl/min 141.5	Nl/min 141.5	Nl/min 141.5
Min/max temperature at 10 bar; 1 MPa; 145 psi	°C From -10 to +50			°C From -10 to +50			
Padlockable knob	Included			Included			
Weight	g 197	g 192	g 183	g 476	g 449	g 445	g 433
Fluid	Compressed air or other inert gases						
Mounting position	In any position			In any position			
Additional air take-off, for pressure gauges or fittings	1/8", front and rear			1/4", front and rear			
Additional air take-off flow rate at 6.3 bar (0.63 MPa; 91 psi) ΔP 1 bar (0.1 MPa; 14 psi)	Nl/min 500 scfm 18			Nl/min 1500 scfm 53			
Wall fixing screws	No. 2 M4 screws			No. 2 M5 screws			
Bobbin capacity for electro-pneumatic version	W 12 VDC and 24 VDC = 2W 24 VAC, 110 VAC and 220 VAC = 3.5 VA			W 12 VDC and 24 VDC = 2W; 24 VAC, 110 VAC and 220 VAC = 3.5 VA 24 VDC = 4W; 24 VAC, 110 VAC, 220 VAC = 4 VA			
Manual control of electro-pneumatic versions	Bistable, with screwdriver slot: horizontal = OFF, vertical = ON						

**PROGRESSIVE STARTER**



TECHNICAL DATA	APR SY 1			APR SY 2			
	1/8"	1/4"	3/8"	3/8"	1/2"	3/4"	1"
Threaded port	1/8"			1/4"			
Threaded discharge port	1/8"			1/4"			
Type of control	Solenoid			Solenoid - Cnomo solenoid			
Inlet pressure	bar 3 - 10 MPa 0.3 - 1 psi 43 - 145			bar 3 - 10 MPa 0.3 - 1 psi 43 - 145			
Flow rate at 6.3 bar (0.63 MPa; 91 psi) ΔP 0.5 bar (0.05 MPa; 7 psi)	Nl/min 900	Nl/min 1000	Nl/min 1100	Nl/min 2800	Nl/min 3600	Nl/min 3600	Nl/min 3600
Flow rate at 6.3 bar (0.63 MPa; 91 psi) ΔP 1 bar (0.1 MPa; 14 psi)	Nl/min 1250	Nl/min 1500	Nl/min 1600	Nl/min 4400	Nl/min 4800	Nl/min 4800	Nl/min 4800
Drain flow rate at 6.3 bar (0.63 MPa; 91 psi)	Nl/min 44	Nl/min 53	Nl/min 57	Nl/min 156	Nl/min 170	Nl/min 170	Nl/min 170
Maximum flow rate start-up, at 6.3 bar (0.63 MPa; 91 psi) with regulation pin completely unscrewed	Nl/min 18	Nl/min 170	Nl/min 170	Nl/min 18	Nl/min 96	Nl/min 700	Nl/min 700
Min/max temperature at 10 bar; 1 MPa; 145 psi	°C From -10 to +50			°C From -10 to +50			
Weight	g 203	g 198	g 189	g 503	g 476	g 472	g 460
Fluid	Compressed air or other inert gases						
Mounting position	In any position			In any position			
Additional air take-off, for pressure gauges or fittings	1/8", front and rear			1/4", front and rear			
Additional air take-off flow rate at 6.3 bar (0.63 MPa; 91 psi) ΔP 1 bar (0.1 MPa; 14 psi)	Nl/min 500 scfm 18			Nl/min 1500 scfm 53			
Wall fixing screws	No. 2 M4 screws			No. 2 M5 screws			
Bobbin capacity for electro-pneumatic version	W 12 VDC and 24 VDC = 2W; 24 VAC, 110 VAC and 220 VAC = 3.5 VA			W 12 VDC and 24 VDC = 2W; 24 VAC, 110 VAC and 220 VAC = 3.5 VA for Cnomo versions: 12 VDC and 24 VDC = 2W; 24 VAC, 110 VAC and 220 VAC = 3.5 VA 24 VDC = 4W; 24 VAC, 110 VAC, 220 VAC = 4 VA			
Manual control	Bistable, with screwdriver slot: horizontal = OFF, vertical = ON						

## AIR TAKE-OFF



TECHNICAL DATA	AIR TAKE-OFF, SY1		AIR TAKE-OFF, SY2	
	Version	PA 2-way	PA 4-way	PA 2-way
Flow rate of the air take-off at 6.3 bar (0.63 MPa; 91 psi) ΔP 1 bar (0.1 MPa; 14 psi)	1550	500 - 2000	7000	1500 - 4500
	Nl/min			
	55	18 - 71	248	53 - 160
Maximum pressure	bar		bar	
	15		13	
	MPa		1.3	
	217		188	
Min/Max temperature at 10 bar; 1 MPa; 145 psi	°C		°C	
	From -10 to 50		From -10 to 50	
Weight	62	100	75	306
Fluid	Compressed air or other inert gases			

### AIR INTAKE, 2-way version

Code	Description
5610P100	PA SY1
5620P100	PA SY2

## PRESSURE SWITCHES



TECHNICAL DATA	SY 1 PRESSURE SWITCHES			SY 2 PRESSURE SWITCHES			
	Threaded port	1/8"	1/4"	3/8"	3/8"	1/2"	3/4"
Adjustable pressure interval	bar			bar			
	0.5 ÷ 10			0.5 ÷ 10			
Hysteresis (not adjustable)	bar			From 0.4 to 0.8			
Maximum pressure	bar			13			
	MPa			1.3			
	psi			188			
Min/Max temperature at 10 bar; 1 MPa; 145 psi	°C			°C			
	From -10 to 50			From -10 to 50			
Maximum current	A			2			
Maximum voltage	V			250			
Outside diameter of cable	mm			4.9			
Number of wires and cross section	3 x 0.5 mm <sup>2</sup>			3 x 0.5 mm <sup>2</sup>			
Contacts	Normally-Open (NO) and Normally-Closed (NC)						
Protection	IP65			IP65			
Number of switchings	5 x 10 <sup>6</sup>			5 x 10 <sup>6</sup>			
Fluid	Filtered lubricated or unlubricated compressed air. Lubrication, if used, must be continuous						
Mounting position	In any position						
Additional air take-off, for pressure gauges or fittings	1/8", front and rear			1/4", front and rear			
Additional air take-off flow rate at 6.3 bar (0.63 MPa; 91 psi) ΔP 1 bar (0.1 MPa; 14 psi)	Nl/min			1500			
	scfm			53			
Wall fixing screws	No. 2 M4 screws			No. 2 M5 screws			
Weight	255	250	241	443	416	412	400

### SECURITY KNOB

Code	Description
9200703	Security knob

## ACCESSORIES

### CONNECTION BRACKETS ON THE BAR (DIN EN50022)

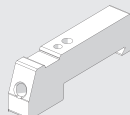

Code	Description
9200718	Connection brackets on DIN bar, SY1 - SY2
Note: 2 pieces per pack complete with screws and washers.	
Max torque 0.8 Nm for SY1 - Max torque 2.0 Nm for SY2	
Codes to be used for units in the standard and the anti-corrosion version	

### MOUNTING BRACKET FOR REG. AND FR



Code	Description
9200701	Acc. SF 100 - BIT-ND 1/4 SY1
9400701	Acc. SF200-ND-3/8 1/2 - SY2

### MOUNTING BRACKET



Code	Description
9200716X	Mounting bracket SY1
9200717X	Mounting bracket SY2
Note: Individually packed with screws and washers	
Max torque 0.8 Nm for SY1 - Max torque 2.0 Nm for SY2	
Codes to be used for units in the standard and the anti-corrosion version	

### ADAPTERS FOR PRESSURE GAUGES (SY2)



Code	Description
9210005	1/4 adapter for 1/8 pressure gauge
Note: no. 20 each box	

### PRESSURE GAUGES



Code	Description
9700101	Acc. M 40 1/8 012
9700102	Acc. M 40 1/8 04
9700109	Acc. M 40 x 40 1/8 04
9700110	Acc. M 40 x 40 1/8 012
9800101	Acc. M 50 1/8 012
9800102	Acc. M 50 1/8 04
9900101	Acc. M 63 1/4 04

## KIT FOR COIL EEXM



Code	Description
0227606913	Kit for coil 30 24 VDC EEXMT5 cable 3 m
0227606915	Kit for coil 30 24 VDC EEXMT5 cable 5 m
0227608013	Kit for coil 30 24 VAC EEXMT5 cable 3 m
0227608015	Kit for coil 30 24 VAC EEXMT5 cable 5 m
0227608023	Kit for coil 30 110 VAC EEXMT5 cable 3 m
0227608025	Kit for coil 30 110 VAC EEXMT5 cable 5 m
0227608033	Kit for coil 30 230 VAC EEXMT5 cable 3 m
0227608035	Kit for coil 30 230 VAC EEXMT5 cable 5 m

According to Atex 94/9 CE rule,  
 Ex II 2G Ex mb IIC T4/T5 Gb  
 Ex II 2D Ex tb IIC T130/T95 °C IP66 Db

## COIL 30 mm



Code	Description
W0210010100	Coil 30 Ø 8 2W-24VDC
W0210011100	Coil 30 Ø 8 3.5VA-24VAC 50/60 HZ
W0210012100	Coil 30 Ø 8 3.5VA-110VAC 50/60 HZ
W0210013100	Coil 30 Ø 8 3.5VA-220VAC 50/60 HZ

## COIL 22 mm



Code	Description
W0215000151	Coil 22 Ø 8 BA 2W-12VDC
W0215000101	Coil 22 Ø 8 BA 2W-24VDC
W0215000111	Coil 22 Ø 8 BA 3.5VA-24VAC
W0215000121	Coil 22 Ø 8 BA 3.5VA-110VAC
W0215000131	Coil 22 Ø 8 BA 3.5VA-220VAC

## "UL" AND "CSA" COIL 22 mm

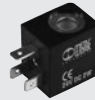

Code	Description
W0215000251	Coil 22 Ø 8 BA 2W-12VDC UR
W0215000201	Coil 22 Ø 8 BA 2W-24VDC UR
W0215000211	Coil 22 Ø 8 BA 3.5VA-24VAC UR
W0215000221	Coil 22 Ø 8 BA 3.5VA-110VAC UR
W0215000231	Coil 22 Ø 8 BA 3.5VA-220VAC UR

## ELECTRIC CONNECTOR 22 mm



Code	Description
W0970510011	Connector standard
W0970510012	Connector 22 LED 24V
W0970510013	Connector 22 LED 110V
W0970510014	Connector 22 LED 220V
W0970510015	Connector 22 LED VDR 24V
W0970510016	Connector 22 LED VDR 110V
W0970510017	Connector 22 LED VDR 220V
W0970510070	Connector 22 II 2 GD ATEX

## ELECTRIC CONNECTOR 30 mm



Code	Description
W0970520033	Connector 30 STD
W0970520034	Connector 30 LED 24V
W0970520035	Connector 30 LED 110V
W0970520036	Connector 30 LED 220V
W0970520037	Connector 30 LED VDR 24V
W0970520038	Connector 30 LED VDR 110V
W0970520039	Connector 30 LED VDR 220V

## M8 STRAIGHT CONNECTOR WITH CABLE FOR PRESSURE SWITCHES



Code	Description
02400A0100	M8 female 3 PIN HIGH FLEX CL6 connector with cable L = 1 m
02400A0250	M8 female 3 PIN HIGH FLEX CL6 connector with cable L = 2.5 m
02400A0500	M8 female 3 PIN HIGH FLEX CL6 connector with cable L = 5 m
02400A1000	M8 female 3 PIN HIGH FLEX CL6 connector with cable L = 10 m

Mobile laying cable, class 6 according to IEC 60228

## BOWL DISASSEMBLY SPANNER



Code	Description
9170601	CS TF - TL BIT/SY1
9210050	CS TF - TL SY2

## KIT COIL SIDE 22 IP65



Code	Description
0222100100	Kit for coils 22 - IP65

Improved IP65 protection, even after prolonged exposure to atmospheric agents.  
 Applicable to valves with a technopolimer control.

## CONNECTING NIPPLE KIT



Code	Description
9210000	Connecting nipple kit SY1
9210010	Connecting nipple kit SY2
9210000X	Connecting nipple kit SY1 anti-corrosion
9210010X	Connecting nipple kit SY2 anti-corrosion

Note: no. 20 each box; Max torque 0.4 Nm  
 Note: no. 10 each box; Max torque 2.5 Nm

## THREADED PORT



Code	Description
9210001*	Acc. kit IN OUT 1/8 SY1
9210002*	Acc. kit IN OUT 1/4 SY1
9210003*	Acc. kit IN OUT 3/8 SY1
9210011**	Acc. kit IN OUT 3/8 SY2
9210012**	Acc. kit IN OUT 1/2 SY2
9210013**	Acc. kit IN OUT 3/4 SY2
9210014**	Acc. kit IN OUT 1 SY2
9210001X	Acc. kit IN OUT 1/8 SY1 anti-corrosion
9210002X	Acc. kit IN OUT 1/4 SY1 anti-corrosion
9210003X	Acc. kit IN OUT 3/8 SY1 anti-corrosion
9210011X	Acc. kit IN OUT 3/8 SY2 anti-corrosion
9210012X	Acc. kit IN OUT 1/2 SY2 anti-corrosion
9210013X	Acc. kit IN OUT 3/4 SY2 anti-corrosion
9210014X	Acc. kit IN OUT 1 SY2 anti-corrosion

\* Note: no. 20 each box; Max torque 0.4 Nm  
 \*\* Note: no. 10 each box; Max torque 2.5 Nm

## ADAPTOR FOR REGTRONIC



Code	Description
9210004	Adaptor for REGTRONIC 1/4 SY1

## SY1 - SY2 SIZE ADAPTER



Code	Description
9210006	SY1 - SY2 size adapter
9210006X	SY1 - SY2 size adapter anti-corrosion

Max torque: 0.4 Nm for SY1  
 Max torque: 2.5 Nm for SY2

## SY1 - SY2 KIT FOR CONNECTION TO SERIE 70 SAFE AIR® VALVES

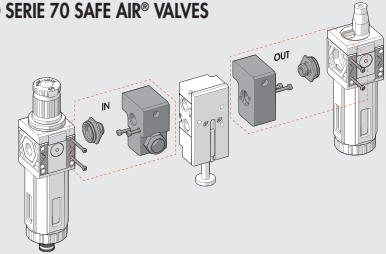

Code	Description
9210015	IN 1/4 SY1 block accessory
9210016	OUT 1/4 SY1 block accessory
9210017	IN 3/8 SY2 block accessory
9210018	OUT 3/8 SY2 block accessory

Max torque for screw, 0.4 Nm for SY1  
 Max torque for screw, 2.5 Nm for SY2

## 90° CONNECTING ELEMENT KIT

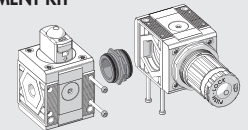

Code	Description
9210009	90° SY1 connection element kit
9210019	90° SY2 connection element kit
9210009X	90° anti-corrosion SY1 connection element kit
9210019X	90° anti-corrosion SY2 connection element kit

Max torque 0.4 Nm for SY1  
 Max torque 2.5 Nm for SY2

## PADLOCK



Code	Description
9062401	Padlock

## WALL-FIXING SCREW



Code	Description
9210030	M4 x 55 fixing screw SY1
9210031	M5 x 75 fixing screw SY2

Note: no. 20 screws and 20 washers each box  
 Max torque 0.8 Nm for SY1  
 Max torque 2.0 Nm for SY2

## SPARE PARTS

### AUTOMATIC DRAIN (RA)



Code	Description
9000802	RA automatic drain spare part

### AUTOMATIC DRAIN (SAC)



Code	Description
9000803	Spare SAC automatic drain

### BOWL RMSA/RA



Code	Description
9210100	Bowl FIL FR DEP RMSA SY1
9210101	Bowl FIL FR RA SY1
9210102	Bowl FIL FR DEP SAC SY1
9210105	Bowl FIL FR DEP RMSA SY2
9210106	Bowl FIL FR RA SY2
9210107	Bowl FIL FR DEP SAC SY2

### LUBRICATOR BOWL



Code	Description
9210110	Bowl LUB SY1
9210115	Bowl LUB SY2

### PURIFIER FILTERING ELEMENT



Code	Description
9210160	Cartridge DEP SY1
9210165	Cartridge DEP SY2

### AC FILTERING ELEMENT (ACTIVE CARBON)



Code	Description
9210161	Cartridge AC SY1
9210166	Cartridge AC SY2

### FILTERING ELEMENT



Code	Description
9210150	Filtering element 5 µm (yellow) SY1
9210151	Filtering element 20 µm (white) SY1
9210152	Filtering element 50 µm (blue) SY1
9210155	Filtering element 5 µm (yellow) SY2
9210156	Filtering element 20 µm (white) SY2
9210157	Filtering element 50 µm (blue) SY2

### TRANSPARENT LUBRICATOR COVER



Code	Description
9210180	Transparent cover LUB SY1
9210185	Transparent cover LUB SY2

### LUBRICATOR OIL-FILLING CAP



Code	Description
9210181	Oil-filling cap LUB SY1
9210186	Oil-filling cap LUB SY2

### SPRINGS FOR REGULATORS AND FR



Code	Description
9210190	Spares MO 02 SY1
9210191	Spares MO 04 SY1 anti-corrosion
9210192	Spares MO 08 SY1
9210193	Spares MO 012 SY1
9210195	Spares MO 02 SY2
9210196	Spares MO 04 SY2
9210197	Spares MO 08 SY2
9210198	Spares MO 012 SY2
9210192X	Spares MO 08 SY1 anti-corrosion
9210193X	Spares MO 012 SY1 anti-corrosion
9210197X	Spares MO 08 SY2 anti-corrosion
9210198X	Spares MO 012 SY2 anti-corrosion

### BELL FOR REG AND FR



Code	Description
9210200	Bell 02 SY1
9210201	Bell 04 SY1
9210202	Bell 08 SY1
9210203	Bell 012 SY1
9210220	Bell 02 SY2
9210221	Bell 04 SY2
9210222	Bell 08 SY2
9210223	Bell 012 SY2
9210202X	Bell 08 SY1 anti-corrosion
9210203X	Bell 012 SY1 anti-corrosion
9210222X	Bell 08 SY2 anti-corrosion
9210223X	Bell 012 SY2 anti-corrosion

### POPPET FOR REG



Code	Description
9210210	Poppet REG SY1
9210230	Poppet REG SY2
9210210X	Poppet REG SY1 anti-corrosion
9210230X	Poppet REG SY2 anti-corrosion

### POPPET FOR FR



Code	Description
9210211	Poppet FR 5 µm SY1
9210212	Poppet FR 20 µm SY1
9210213	Poppet FR 50 µm SY1
9210231	Poppet FR 5 µm SY2
9210232	Poppet FR 20 µm SY2
9210233	Poppet FR 50 µm SY2

### CNOMO CONTROL FOR V3V AND APR SY2



Code	Description
9453922	Elpn Cnomo control kit, manual bistable

## bit STANDARD



GENERAL TECHNICAL DATA	BIT 1/8"	BIT 1/4"
Threaded port	1/8"	1/4"
Degree of filtration	5 (yellow) - 20 (white) - 50 (blue)	
Degree of purification	99.97% @ 0.01 μm	
Setting range	0 to 2 - 0 to 4 - 0 to 8 - 0 to 12	
Max. inlet pressure	1.3	
	13	
	188	
Flow rate at 6.3 bar (0.63 MPa to 91 psi) ΔP 0.5 bar (0.05 MPa to 7 psi)	350	
	12	
Max temperature at 1 MPa; 10 bar; 145 psi	- 10° to + 50°	
	14° to 122°	
Elements	Filter – Regulator – Lubricator – Filter-regulator – Depurator	
Mounting	Units: FRL, FR+L, F+L, F+D	
Fluid	By means of the bracket provided	
	Compressed air	

## FILTER



TECHNICAL DATA	BIT 1/8"	BIT 1/4"
Threaded port	1/8"	1/4"
Degree of filtration	5 (yellow) - 20 (white) - 50 (blue)	
Max. inlet pressure	1.3	
	13	
	188	
Flow rate at 6.3 bar (0.6 MPa to 91 psi) ΔP 0.5 bar (0.05 MPa to 7 psi)	860	
	30.5	
Flow rate at 6.3 bar (0.6 MPa to 91 psi) ΔP 1 bar (0.1 MPa to 14 psi)	1200	
	42.5	
Max temperature at 1 MPa; 10 bar; 145 psi	50	
	122	
Weight	40	
Wall fixing screws	M4, by means of the bracket provided	
Bowl capacity	16	
Mounting position	Vertical	
Condensate drain	RMSA: drain with manual condensate discharge and automatic discharge at zero pressure SAC: automatic drain with condensate discharge .	
Fluid	<b>Operates by depression – requires variable air take-offs.</b> Compressed air	

Code	Description	Code	Description	Code	Description
5101001	FIL BIT 1/8 5 RMSA	5101003	FIL BIT 1/8 50 RMSA	5201002	FIL BIT 1/4 20 RMSA
5101004	FIL BIT 1/8 5 SAC	5101006	FIL BIT 1/8 50 SAC	5201005	FIL BIT 1/4 20 SAC
5101002	FIL BIT 1/8 20 RMSA	5201001	FIL BIT 1/4 5 RMSA	5201003	FIL BIT 1/4 50 RMSA
5101005	FIL BIT 1/8 20 SAC	5201004	FIL BIT 1/4 5 SAC	5201006	FIL BIT 1/4 50 SACC

## DEPURATOR



TECHNICAL DATA	DEP BIT 1/8"		DEP BIT 1/4"	
	1/8"		1/4"	
Threaded port				
Degree of purification	99.97% 0.01 μm			
Max. inlet pressure	MPa	1.3		
	bar	13		
	psi	188		
Suggested flow at 6 bar	NI/min	200		
	scfm	7		
Max temperature at 1 MPa; 10 bar; 145 psi	°C	50		
	°F	122		
Weight	g	65		
Wall fixing screws	M4, by means of the bracket provided			
Bowl capacity	cm <sup>3</sup>	16		
Mounting position	Vertical			
Condensate drain	RMSA: drain with manual condensate discharge and automatic discharge at zero pressure.			
Fluid	Filtered 5 μm compressed air			
Notes	A It is advisable to mount a 5 m filter upstream the depurator acting as a rough filter.			

Code	Description			
5112001	DEP BIT 1/8 RMSA			
5212001	DEP BIT 1/4 RMSA			

## LUBRICATOR



TECHNICAL DATA	LUB BIT 1/8"		LUB BIT 1/4"	
	1/8"		1/4"	
Threaded port				
Type of lubrication	Oil mist			
Bowl capacity	cm <sup>3</sup>	26.5		
Lubricator version	Manual filling with the bowl disassembled			
Max. inlet pressure	MPa	1.3		
	bar	13		
	psi	188		
Flow rate at 6.3 bar (0.63 MPa to 91 psi) ΔP 0.5 bar (0.05 MPa to 7 psi)	NI/min	400		
	scfm	14		
Flow rate at 6.3 bar (0.63 MPa to 91 psi) ΔP 1 bar (0.1 MPa to 14 psi)	NI/min	710		
	scfm	25		
Max temperature at 1 MPa; 10 bar; 145 psi	°C	50		
	°F	122		
Weight	g	40		
Wall fixing screws	M4, by means of the bracket provided			
Mounting position	Vertical			
Fluid	Filtered compressed air			

Code	Description			
5103001	LUB BIT 1/8			
5203001	LUB BIT 1/4			



**MICRO-REGULATOR**



TECHNICAL DATA	MR BIT 1/8"	MR BIT 1/4"
Threaded port	1/8"	1/4"
Setting range	0 to 2 - 0 to 4 - 0 to 8 - 0 to 12	
Max. inlet pressure	MPa bar psi	
Flow rate at 6.3 bar (0.63 MPa to 91 psi) ΔP 0.5 bar (0.05 MPa to 7 psi)	NI/min scfm	
Flow rate at 6.3 bar (0.63 MPa to 91 psi) ΔP 1 bar (0.1 MPa to 14 psi)	NI/min scfm	
Max temperature at 1 MPa; 10 bar; 145 psi	°C °F	
Weight	g	
Wall fixing screws	M4, by means of the bracket provided	
Gauge port	G 1/8"	
Mounting position	In any position	
Fluid	Filtered, lubricated or unlubricated compressed air. Lubrication, if used, must be continuous.	
Notes	The regulator pressure must always be set upwards. For increased sensitivity, use a pressure regulator with a rated pressure as close as possible to the required value.	

Code	Description	Code	Description	Code	Description	Code	Description
<b>MICROREGULATOR (MR)</b>		<b>MICROREGULATOR WITH CONTROLLED RELIEF</b>		<b>MICROREGULATOR WITH QUICK RELIEF</b>		<b>WATER MICROREGULATOR</b>	
5107004	MR BIT 1/8 012	5111001	MR BIT FC 1/8 02	5102001	MR BIT SR 1/8 02	5108001	MRA BIT 1/8 02
5107001	MR BIT 1/8 02	5111002	MR BIT FC 1/8 04	5102002	MR BIT SR 1/8 04	5108002	MRA BIT 1/8 04
5107002	MR BIT 1/8 04	5211001	MR BIT FC 1/4 02	5102003	MR BIT SR 1/8 08	5108003	MRA BIT 1/8 08
5107003	MR BIT 1/8 08	5211002	MR BIT FC 1/4 04	5102004	MR BIT SR 1/8 012	5108004	MRA BIT 1/8 012
5207004	MR BIT 1/4 012			5202001	MR BIT SR 1/4 02	5208001	MRA BIT 1/4 02
5207001	MR BIT 1/4 02			5202002	MR BIT SR 1/4 04	5208002	MRA BIT 1/4 04
5207002	MR BIT 1/4 04			5202003	MR BIT SR 1/4 08	5208003	MRA BIT 1/4 08
5207003	MR BIT 1/4 08			5202004	MR BIT SR 1/4 012	5208004	MRA BIT 1/4 012

FC: Controlled relief  
 SR: Quickly relieved  
 MRA: Without relief (for water)

**PADLOCKABLE MICROREGULATOR**



Look at microregulator for technical data

Code	Description	Code	Description
5110001	MR BIT KEY 1/8 02	5210001	MR BIT KEY 1/4 02
5110002	MR BIT KEY 1/8 04	5210002	MR BIT KEY 1/4 04
5110003	MR BIT KEY 1/8 08	5210003	MR BIT KEY 1/4 08
5110004	MR BIT KEY 1/8 012	5210004	MR BIT KEY 1/4 012

## FILTER REGULATOR



TECHNICAL DATA	FR BIT 1/8"		FR BIT 1/4"	
	1/8"		1/4"	
Threaded port	0 to 2 - 0 to 4 - 0 to 8 - 0 to 12			
Setting range	5 (yellow) - 20 (white) - 50 (blue)			
Degree of filtration	µm			
Max. inlet pressure	MPa	1.3		
	bar	13		
	psi	188		
Flow rate at 6.3 bar (0.63 MPa to 91 psi) ΔP 0.5 bar (0.05 MPa to 7 psi)	Nl/min	290		
	scfm	10		
Flow rate at 6.3 bar (0.63 MPa to 91 psi) ΔP 1 bar (0.1 MPa to 14 psi)	Nl/min	600		
	scfm	21		
Max temperature at 1 MPa; 10 bar; 145 psi	°C	50		
	°F	122		
Weight	g	110		
Wall fixing screws		M4, by means of the bracket provided		
Bowl capacity	cm <sup>3</sup>	16		
Mounting position		Vertical		
Gauge port		G 1/8"		
Condensate drain		RMSA: drain with manual condensate discharge and automatic discharge at zero pressure SAC: automatic drain with condensate discharge.		
Fluid		<b>Operates by depression – requires variable air take-offs.</b> Compressed air		
Notes		The regulator pressure must always be set upwards. For increased sensitivity, use a pressure regulator with a rated pressure as close as possible to the required value.		

UNITS

Code	Description	Code	Description	Code	Description	Code	Description
5105001	FR BIT 1/8 5 02 RMSA	5105007	FR BIT 1/8 5 08 RMSA	5205001	FR BIT 1/4 5 02 RMSA	5205007	FR BIT 1/4 5 08 RMSA
5105013	FR BIT 1/8 5 02 SAC	5105019	FR BIT 1/8 5 08 SAC	5205013	FR BIT 1/4 5 02 SAC	5205019	FR BIT 1/4 5 08 SAC
5105002	FR BIT 1/8 20 02 RMSA	5105008	FR BIT 1/8 20 08 RMSA	5205002	FR BIT 1/4 20 02 RMSA	5205008	FR BIT 1/4 20 08 RMSA
5105014	FR BIT 1/8 20 02 SAC	5105020	FR BIT 1/8 20 08 SAC	5205014	FR BIT 1/4 20 02 SAC	5205020	FR BIT 1/4 20 08 SAC
5105003	FR BIT 1/8 50 02 RMSA	5105009	FR BIT 1/8 50 08 RMSA	5205003	FR BIT 1/4 50 02 RMSA	5205009	FR BIT 1/4 50 08 RMSA
5105015	FR BIT 1/8 50 02 SAC	5105021	FR BIT 1/8 50 08 SAC	5205015	FR BIT 1/4 50 02 SAC	5205021	FR BIT 1/4 50 08 SAC
5105004	FR BIT 1/8 5 04 RMSA	5105010	FR BIT 1/8 5 012 RMSA	5205004	FR BIT 1/4 5 04 RMSA	5205010	FR BIT 1/4 5 012 RMSA
5105016	FR BIT 1/8 5 04 SAC	5105022	FR BIT 1/8 5 012 SAC	5205016	FR BIT 1/4 5 04 SAC	5205022	FR BIT 1/4 5 012 SAC
5105005	FR BIT 1/8 20 04 RMSA	5105011	FR BIT 1/8 20 012 RMSA	5205005	FR BIT 1/4 20 04 RMSA	5205011	FR BIT 1/4 20 012 RMSA
5105017	FR BIT 1/8 20 04 SAC	5105023	FR BIT 1/8 20 012 SAC	5205017	FR BIT 1/4 20 04 SAC	5205023	FR BIT 1/4 20 012 SAC
5105006	FR BIT 1/8 50 04 RMSA	5105012	FR BIT 1/8 50 012 RMSA	5205006	FR BIT 1/4 50 04 RMSA	5205012	FR BIT 1/4 50 012 RMSA
5105018	FR BIT 1/8 50 04 SAC	5105024	FR BIT 1/8 50 012 SAC	5205018	FR BIT 1/4 50 04 SAC	5205024	FR BIT 1/4 50 012 SAC

bit

## TAKE-OFF



TECHNICAL DATA		PA
Maximum operating pressure	MPa	1.3
	bar	13
	psi	188
Maximum working temperature at 1 MPa; 10 bar; 145 psi	°C	50
	°F	122

Code	Description
9100401	PA 1/8 - 1/4 BIT

## FIL+REG+LUB



Code	Description
5104008	FRL BIT 1/8 20 08 RMSA
5104011	FRL BIT 1/8 20 012 RMSA
5204008	FRL BIT 1/4 20 08 RMSA
5204011	FRL BIT 1/4 20 012 RMSA

The following versions are available on request:  
 - with 5 µm or 50 µm degree of filtration  
 - with 0-2 bar or 0-4 bar setting range  
 - with SAC condensate discharge

## FR+LUB



Code	Description
5106008	FR+L BIT 1/8 20 08 RMSA
5106011	FR+L BIT 1/8 20 012 RMSA
5204008	FR+L BIT 1/4 20 08 RMSA
5206008	FR+L BIT 1/4 20 012 RMSA

The following versions are available on request:  
 - with 5 µm or 50 µm degree of filtration  
 - with 0-2 bar or 0-4 bar setting range  
 - with SAC condensate discharge

## FIL+DEP



Code	Description
5114001	F+D BIT 1/8 5 RMSA - RMSA
5114002	F+D BIT 1/8 5 SAC - RMSA
5214001	F+D BIT 1/4 5 RMSA - RMSA
5214002	F+D BIT 1/4 5 SAC - RMSA

## FIL+LUB



Code	Description
5113002	F+L BIT 1/8 20 RMSA
5213002	F+L BIT 1/4 20 RMSA

The following versions are available on request:  
 - with 5 µm or 50 µm degree of filtration  
 - with SAC condensate discharge

## bit SERIES F FOR WATER



GENERAL TECHNICAL DATA		BIT F 1/8"	BIT F 1/4"
Threaded port		1/8"	1/4"
Max. inlet pressure	MPa bar psi		1.3 13 188
Max temperature at 10 bar (1 MPa; 145 psi)	°C °F		50 122
Elements		Filter - Regulator - Filter regulator	
Mounting		Fixed to a wall, using fixing plate code 9170301 and M4 screws, or fixing bracket code 9200701 for the threaded regulator and filter-regulator bell.	
Fluid		Panel-mounted using the threaded bell of the regulator or filter-regulator (∅ hole 30-32 mm). Water, air and fluids compatible with the materials used	

## FILTER SERIES F FOR WATER



TECHNICAL DATA		FIL BIT F 1/8"	FIL BIT F 1/4"
Threaded port		1/8"	1/4"
Degree of filtration	µm		20 (white)
Max. inlet pressure	MPa bar psi		1.3 13 188
Flow rate at 6.3 bar (0.63 MPa ÷ 91 psi) ΔP 1 bar (0.1 MPa; 14 psi)	l/min cfm	13 0.46	14.5 0.51
Max temperature at 10 bar (1 MPa; 145 psi)	°C °F		50 122
Weight	g		40
Internal volume	cm³		40
Mounting position		In any position	
Fluid		Water, air and fluids compatible with the materials used	

Code	Description
5101002F	FIL BIT F 1/8 20
5201002F	FIL BIT F 1/4 20

## REGULATOR SERIES F FOR WATER



TECHNICAL DATA	REG BIT F 1/8"		REG BIT F 1/4"
	1/8"	0 to 2; 0 to 4; 0 to 8; 0 to 12	1/4"
Threaded port			
Setting range	bar	1.3	
Max. inlet pressure	MPa	13	
	bar	188	
	psi		
Flow rate at 6.3 bar (0.63 MPa ÷ 91 psi) ΔP 1 bar (0.1 MPa; 14 psi)	l/min	6.5	7
	scfm	0.23	0.25
Max temperature at 10 bar (1 MPa; 145 psi)	°C	50°	
	°F	122°	
Weight	g	80	
Versions	With 1/8" or 1/4" brass threaded ports and 1/8" pressure gauge port. With 1/4" engineering plastic threaded ports, without pressure gauge ports		
Mounting position	In any position		
Fluid	Water, air and fluids compatible with the materials used		
Notes	The pressure must always be set upwards. For increased sensitivity, use a pressure regulator with a rated pressure as close as possible to the required value.		

Code	Description
<b>REGULATOR WITH BRASS PORTS</b>	
5108001F	REG BIT F 1/8 02
5108002F	REG BIT F 1/8 04
5108003F	REG BIT F 1/8 08
5108004F	REG BIT F 1/8 012
5208001F	REG BIT F 1/4 02
5208002F	REG BIT F 1/4 04
5208003F	REG BIT F 1/4 08
5208004F	REG BIT F 1/4 012

Code	Description
<b>REGULATOR WITH TECHNOPOLYMER PORTS **</b>	
5228001F	REG BIT F 1/4 TP 02
5228002F	REG BIT F 1/4 TP 04
5228003F	REG BIT F 1/4 TP 08
5228004F	REG BIT F 1/4 TP 012
** Without pressure gauge ports	

## FILTER-REGULATOR SERIES F FOR WATER



TECHNICAL DATA	FR BIT F 1/8"		FR BIT F 1/4"
	1/8"	0 to 2; 0 to 4; 0 to 8; 0 to 12	1/4"
Threaded port			
Setting range	bar	20 (white)	
Degree of filtration	μm	13	
Max. inlet pressure	MPa	188	
	bar		
	psi		
Flow rate at 6.3 bar (0.63 MPa ÷ 91 psi) ΔP 1 bar (0.1 MPa; 14 psi)	l/min	6	6
	cfm	0.21	0.21
Max temperature at 10 bar (1 MPa; 145 psi)	°C	50	
	°F	122	
Weight	g	110	
Mounting position	In any position		
Fluid	Water, air and fluids compatible with the materials used		
Notes	The pressure must always be set upwards. For increased sensitivity, use a pressure regulator with a rated pressure as close as possible to the required value.		

Code	Description
5105102F	FR BIT F 1/8 20 02
5105105F	FR BIT F 1/8 20 04
5105108F	FR BIT F 1/8 20 08
5105111F	FR BIT F 1/8 20 012
5205102F	FR BIT F 1/4 20 02
5205105F	FR BIT F 1/4 20 04
5205108F	FR BIT F 1/4 20 08
5205111F	FR BIT F 1/4 20 012

## ACCESSORIES FOR STANDARD bit AND SERIES F bit FOR WATER

### PRESSURE GAUGE\*

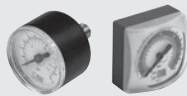

Code	Description
9700101	Acc. M 40 1/8 012
9700102	Acc. M 40 1/8 04
9800101	Acc. M 50 1/8 012
9800102	Acc. M 50 1/8 04
9900101	Acc. M 63 1/4 04
9700109	Acc. M 40 x 40 1/8 04
9700110	Acc. M 40 x 40 1/8 012

\* Cannot be used with water

### R/FR FIXING BRACKET



Code	Description
9200701	Acc. SF100 - BIT - ND 1/4 - SY1

### WALL MOUNTING BRACKET (PAIR)



Code	Description
9170301	Acc. SFB 1/8 - 1/4 BIT

### ASSEMBLY PLATE (PAIR)

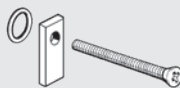

Code	Description
9170201	Acc. PAB 1/8 - 1/4 BIT

### DOME DISASSEMBLY PANNER



Code	Description
9220701	Acc. cover LUB spanner

### COVER DISASSEMBLY SPANNER



Code	Description
9170401	Acc. CS CS BIT

### REDUCER PLUG DISASSEMBLY SPANNER



Code	Description
9170501	Acc. CS OTR BIT

### BOWL DISASSEMBLY SPANNER

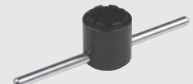

Code	Description
9170601	Acc. CS TF - TL BIT - SY1

## SPARE PARTS FOR STANDARD bit

### UPPER COVER FOR MR



Code	Description
9250805	Spare CS 1/8 1/4 BIT 02
9250806	Spare CS 1/8 1/4 BIT 04
9250807	Spare CS 1/8 1/4 BIT 08
9250808	Spare CS 1/8 1/4 BIT 012

### COMPLETE POPPET FOR MR AND MRA



Code	Description
9250705	Spare poppet for MR
9250706	Spare poppet for MR-SR (rapid drain)
9250708	Spare poppet for MRA

### FILTER ELEMENT



Code	Description
9251708	Spare FP 1/8-1/4 BIT 5 (yellow)
9251709	Spare FP 1/8-1/4 BIT 20 (white)
9251710	Spare FP 1/8-1/4 BIT 50 (blue)

### COMPLETE POPPET FOR FR



Code	Description
9250905	Spare OTRF 1/8 1/4 BIT 5
9250906	Spare OTRF 1/8 1/4 BIT 20
9250907	Spare OTRF 1/8 1/4 BIT 50

### UPPER COVER FOR MR FC



Code	Description
9250817	Spare CS FC 1/8 1/4 BIT 02
9250818	Spare CS FC 1/8 1/4 BIT 04

### FILTER AND FILTER-REGULATOR BOWL



Code	Description
9255001	Spare TF 1/8 1/4 BIT RMSA
9255101	Spare TF 1/8 1/4 BIT SAC

### FILTER CARTRIDGE



Code	Description
9251808	Spares filter cartridge BIT 5 (yellow)
9251809	Spares filter cartridge BIT 20 (white)
9251810	Spares filter cartridge BIT 50 (blue)

### TRANSPARENT LUBRICATOR COVER



Code	Description
9251302	Spare CVL 100-200-300-400 BIT

### UPPER COVER FOR MRA



Code	Description
9250809	Spare CSA 1/8 - 1/4 BIT 02
9250814	Spare CSA 1/8 - 1/4 BIT 04
9250815	Spare CSA 1/8 - 1/4 BIT 08
9250816	Spare CSA 1/8 - 1/4 BIT 012

### AUTOMATIC DRAIN (SAC)



Code	Description
9000803	Spare SAC automatic drain

### LUBRICATOR BOWL



Code	Description
9251402	Spare TL 1/8 1/4 BIT

### DEPURATOR FILTER ELEMENT



Code	Description
9251712	Spare FP DEP. 1/8 1/4 BIT

### SPRING



Code	Description
9250610	Spare MO 02 BIT
9250611	Spare MO 04 BIT
9250612	Spare MO 08 BIT
9250613	Spare MO 012 BIT

## SPARE PARTS FOR SERIES F bit FOR WATER

### FILTER ELEMENT



Code	Description
9251709	Spares FP 1/8-1/4 BIT 20 (white)

### FILTER CARTRIDGE



Code	Description
9251809	Spares filter cartridge BIT 20 (white)

### SPRING FOR REG F, FR F



Code	Description
9250610	Spares MO 02 BIT
9250611	Spares MO 04 BIT
9250612	Spares MO 08 BIT
9250613	Spares MO 012 BIT



GENERAL TECHNICAL DATA	SK 100		SK 200			SK 300			SK 400			
Threaded port	1/4"	3/8"	1/4"	3/8"	1/2"	1/2"	3/4"	1"	1"	1 1/4"	1 1/2"	2"
Degree of filtration	5 - 20 - 50											
Degree of purification	99.97% at 0.01											
Setting range	0 to 2 0 to 4 0 to 8 0 to 12											
Max. input pressure	MPa		1.5			1.3			1.3			
	bar		15			13			13			
	psi		217			188			188			
Flow rate at 6.3 bar (0.63 MPa to 91 psi)	NL/min											
ΔP 0.5 bar (0.05 MPa to 7 psi)	From 1100 to 20000											
Fluid	Lubricated or unlubricated compressed air											
Temperature range at 1 MPa; 10 bar; 145 psi	°C											
	-10 to +50											
	°F											
	14 to 122											
Elements comprising the range	Filter, Depurator, Regulator, Pilot operated regulator, In-series Regulator, Filter-regulator, Lubricator with various lubricant filling systems, Circuit Shut-off Valve, Progressive Actuator.											

## DEPURATOR



TECHNICAL DATA	DEP 100		DEP 200		DEP 300		DEP 400				
Threaded port	1/4"	3/8"	1/4"	3/8"	1/2"	3/4"	1"	1"	1 1/4"	1 1/2"	2"
Degree of purification	99.97% at 0.01 μm		99.97% at 0.01 μm		99.97% at 0.01 μm		99.97% at 0.01 μm				
Max. inlet pressure	MPa		1.5		1.3		1.3				
	bar		15		13		13				
	psi		217		188		188				
Suggested flow at 6 bar	NL/min		230		360		500				
Max temperature at: 1 MPa; 10 bar; 145 psi	°C		50		50		50				
	°F		122		122		122				
Weight	kg		0.4		0.9		1.4				
Wall fixing screws	M4 x 50		M5 x 60		M5 x 70		M6 x 110				
Bowl capacity	cm³		22		45		75				
Mounting position	Vertical		Vertical		Vertical		Vertical				
Drain	RMSA		RMSA		RMSA - RA		RMSA - RA				
Fluid	RMSA: drain with manual condensate discharge and automatic discharge at zero pressure RA: automatic drain with condensate discharge, independent of pressure and flow rate Version conveys the draining by inserting the pipe having internal diameter 6 mm in the lower port. 5 μm filtered air										
Notes on use	It is advisable to mount a 5 μm pre-filter in order to separate the solid particles first. <b>The maximum inlet pressure for the version with RA automatic condensate drainage must not exceed 10 bar.</b>										

Code	Description
<b>Skillair® 100 DEPURATOR</b>	
3288001A	D 100 RMSA without end plates
3288001	D 100 1/4 RMSA
3388001	D 100 3/8 RMSA

Code	Description
<b>Skillair® 200 DEPURATOR</b>	
3488001A	D 200 RMSA without end plates
3488001	D 200 1/4 RMSA
3588001	D 200 3/8 RMSA
3688001	D 200 1/2 RMSA

Code	Description
<b>Skillair® 300 DEPURATOR</b>	
4488001A	D 300 RMSA without end plates
4488002A	D 300 RA without end plates
4488001	D 300 1/2 RMSA
4488002	D 300 1/2 RA
4588001	D 300 3/4 RMSA
4588002	D 300 3/4 RA
4688001	D 300 1 RMSA
4688002	D 300 1 RA

Code	Description
<b>Skillair® 400 DEPURATOR</b>	
6188001A	D 400 RMSA without end plates
6188002A	D 400 RA without end plates
6188001	D 400 1 RMSA
6188002	D 400 1 RA
6288001	D 400 1 1/4 RMSA
6288002	D 400 1 1/4 RA
6388001	D 400 1 1/2 RMSA
6388002	D 400 1 1/2 RA
6488001	D 400 2 RMSA
6488002	D 400 2 RA



## FILTER



TECHNICAL DATA	FIL 100		FIL 200			FIL 300			FIL 400			
		1/4"   3/8"	1/4"   3/8"   1/2"	1/2"   3/4"   1"	1"	1 1/4"   1 1/2"   2"						
Threaded port		5 - 20 - 50	5 - 20 - 50	5 - 20 - 50	5 - 20 - 50	5 - 20 - 50	5 - 20 - 50	5 - 20 - 50	5 - 20 - 50	5 - 20 - 50	5 - 20 - 50	5 - 20 - 50
Degree of filtration	µm	1.5	1.3	1.3	1.3	1.3	1.3	1.3	1.3	1.3	1.3	1.3
Max. input pressure	MPa	15	13	13	13	13	13	13	13	13	13	13
	bar	217	188	188	188	188	188	188	188	188	188	188
	psi	1400	2400	3800	16500	20000	710	710	710	710	710	710
Flow rate at 6.3 bar (0.63 MPa to 91 psi)	Nl/min	50	85	135	590	20000	710	710	710	710	710	710
ΔP 0.5 bar (0.05 MPa to 7 psi)	scfm	2000	3100	5300	-	-	-	-	-	-	-	-
Flow rate at 6.3 bar (0.63 MPa to 91 psi)	Nl/min	71	110	188	50	50	50	50	50	50	50	50
ΔP 1 bar (0.1 MPa to 14 psi)	scfm	50	50	50	50	50	50	50	50	50	50	50
Max temperature at 1 MPa; 10 bar; 145 psi	°C	122	122	122	122	122	122	122	122	122	122	122
	°F	0.4	0.7	1.4	5.2	6	6	6	6	6	6	6
Weight	kg	M4 x 50	M5 x 60	M5 x 70	M6 x 110	M6 x 110	M6 x 110	M6 x 110	M6 x 110	M6 x 110	M6 x 110	M6 x 110
Wall fixing screws		22	45	75	270	270	270	270	270	270	270	270
Bowl capacity	cm³	Vertical	Vertical	Vertical	Vertical	Vertical	Vertical	Vertical	Vertical	Vertical	Vertical	Vertical
Mounting position		RMSA - SAC	RMSA - SAC - RA	RMSA - RA	RMSA - RA	RMSA - RA	RMSA - RA	RMSA - RA	RMSA - RA	RMSA - RA	RMSA - RA	RMSA - RA
Drain		RMSA: drain with manual condensate discharge and automatic discharge at zero pressure RA: automatic drain with condensate discharge, independent of pressure and flow rate Version conveys the draining by inserting the pipe having internal diameter 6 mm in the lower port. SAC: automatic drain with condensate discharge. <b>Operates by depression – requires variable air take-offs.</b> Compressed air.										
Fluid		The maximum inlet pressure for the version with RA automatic condensate drainage must not exceed 10 bar.										
Notes on use												

Code	Description
<b>Skillair® 100 FILTER</b>	
3280001A	FIL 100 5 RMSA without end plates
3280007A	FIL 100 5 SAC without end plates
3280002A	FIL 100 20 RMSA without end plates
3280008A	FIL 100 20 SAC without end plates
3280003A	FIL 100 50 RMSA without end plates
3280009A	FIL 100 50 SAC without end plates
3280001	FIL 100 1/4 5 RMSA
3280007	FIL 100 1/4 5 SAC
3280002	FIL 100 1/4 20 RMSA
3280008	FIL 100 1/4 20 SAC
3280003	FIL 100 1/4 50 RMSA
3280009	FIL 100 1/4 50 SAC
3380001	FIL 100 3/8 5 RMSA
3380007	FIL 100 3/8 5 SAC
3380002	FIL 100 3/8 20 RMSA
3380008	FIL 100 3/8 20 SAC
3380003	FIL 100 3/8 50 RMSA
3380009	FIL 100 3/8 50 SAC

Code	Description
<b>Skillair® 200 FILTER</b>	
3480001A	FIL 200 5 RMSA without end plates
3480007A	FIL 200 5 SAC without end plates
3480002A	FIL 200 20 RMSA without end plates
3480008A	FIL 200 20 SAC without end plates
3480003A	FIL 200 50 RMSA without end plates
3480009A	FIL 200 50 SAC without end plates
3480001	FIL 200 1/4 5 RMSA
3480007	FIL 200 1/4 5 SAC
3480002	FIL 200 1/4 20 RMSA
3480008	FIL 200 1/4 20 SAC
3480003	FIL 200 1/4 50 RMSA
3480009	FIL 200 1/4 50 SAC
3580001	FIL 200 3/8 5 RMSA
3580007	FIL 200 3/8 5 SAC
3580002	FIL 200 3/8 20 RMSA
3580008	FIL 200 3/8 20 SAC
3580003	FIL 200 3/8 50 RMSA
3580009	FIL 200 3/8 50 SAC
3680001	FIL 200 1/2 5 RMSA
3680007	FIL 200 1/2 5 SAC
3680002	FIL 200 1/2 20 RMSA
3680008	FIL 200 1/2 20 SAC
3680003	FIL 200 1/2 50 RMSA
3680009	FIL 200 1/2 50 SAC

Code	Description
<b>Skillair® 300 FILTER</b>	
4480001A	FIL 300 5 RMSA without end plates
4480002A	FIL 300 20 RMSA without end plates
4480003A	FIL 300 50 RMSA without end plates
4480004A	FIL 300 5 RA without end plates
4480005A	FIL 300 20 RA without end plates
4480006A	FIL 300 50 RA without end plates
4480001	FIL 300 1/2 5 RMSA
4480002	FIL 300 1/2 20 RMSA
4480003	FIL 300 1/2 50 RMSA
4480004	FIL 300 1/2 5 RA
4480005	FIL 300 1/2 20 RA
4480006	FIL 300 1/2 50 RA
4580001	FIL 300 3/4 5 RMSA
4580002	FIL 300 3/4 20 RMSA
4580003	FIL 300 3/4 50 RMSA
4580004	FIL 300 3/4 5 RA
4580005	FIL 300 3/4 20 RA
4580006	FIL 300 3/4 50 RA
4680001	FIL 300 1 5 RMSA
4680002	FIL 300 1 20 RMSA
4680003	FIL 300 1 50 RMSA
4680004	FIL 300 1 5 RA
4680005	FIL 300 1 20 RA
4680006	FIL 300 1 50 RA

Code	Description
<b>Skillair® 400 FILTER</b>	
6180001A	FIL 400 5 RMSA without end plates
6180002A	FIL 400 20 RMSA without end plates
6180003A	FIL 400 50 RMSA without end plates
6180004A	FIL 400 5 RA without end plates
6180005A	FIL 400 20 RA without end plates
6180006A	FIL 400 50 RA without end plates
6180001	FIL 400 1 5 RMSA
6180002	FIL 400 1 20 RMSA
6180003	FIL 400 1 50 RMSA
6180004	FIL 400 1 5 RA
6180005	FIL 400 1 20 RA
6180006	FIL 400 1 50 RA
6280001	FIL 400 1 1/4 5 RMSA
6280002	FIL 400 1 1/4 20 RMSA
6280003	FIL 400 1 1/4 50 RMSA
6280004	FIL 400 1 1/4 5 RA
6280005	FIL 400 1 1/4 20 RA
6280006	FIL 400 1 1/4 50 RA
6380001	FIL 400 1 1/2 5 RMSA
6380002	FIL 400 1 1/2 20 RMSA
6380003	FIL 400 1 1/2 50 RMSA
6380004	FIL 400 1 1/2 5 RA
6380005	FIL 400 1 1/2 20 RA
6380006	FIL 400 1 1/2 50 RA
6480001	FIL 400 2 5 RMSA
6480002	FIL 400 2 20 RMSA
6480003	FIL 400 2 50 RMSA
6480004	FIL 400 2 5 RA
6480005	FIL 400 2 20 RA
6480006	FIL 400 2 50 RA

## ACTIVE CARBON FILTER



TECHNICAL DATA	AC 100		AC 200			AC 300			AC 400				
	1/4"	3/8"	1/4"	3/8"	1/2"	1/2"	3/4"	1"	1"	1 1/4"	1 1/2"	2"	
Threaded port													
Residual oil at 20°C *	mg/m <sup>3</sup>	0.003	0.003	0.003	0.003	0.003	0.003	0.003	0.003	0.003	0.003	0.003	0.003
Duration of cartridge *	hours	4000	4000	4000	4000	4000	4000	4000	4000	4000	4000	4000	4000
Max. inlet pressure	MPa	1.5	1.3	1.3	1.3	1.3	1.3	1.3	1.3	1.3	1.3	1.3	1.3
	bar	15	13	13	13	13	13	13	13	13	13	13	13
	psi	217	188	188	188	188	188	188	188	188	188	188	188
Max temperature at: 1 MPa; 10 bar; 145 psi	°C	50	50	50	50	50	50	50	50	50	50	50	50
	°F	122	122	122	122	122	122	122	122	122	122	122	122
Weight	kg	0.4	0.9	0.9	0.9	1.4	1.4	1.4	1.4	4.2	4.2	4.2	5
Wall fixing screws		M4 x 50	M5 x 60	M5 x 60	M5 x 60	M5 x 70	M5 x 70	M5 x 70	M5 x 70	M6 x 110	M6 x 110	M6 x 110	M6 x 110
Mounting position		In any position.											
Fluid		0.01 µm filtered and dehydrated air.											
Notes on use		Upstream it's necessary to mount a coalescence filter dehydrator of 0.01 µm.											
* if the load loss of 75 mbar is not exceeded													

Code	Description	Code	Description	Code	Description	Code	Description
<b>Skillair® 100 ACTIVE CARBON FILTER</b>		<b>Skillair® 200 ACTIVE CARBON FILTER</b>		<b>Skillair® 300 ACTIVE CARBON FILTER</b>		<b>Skillair® 400 ACTIVE CARBON FILTER</b>	
3288003A	FIL AC 100 RMSA without end plates	3488003A	FIL AC 200 RMSA without end plates	4488003A	FIL AC 300 RMSA without end plates	6188003A	FIL AC 400 RMSA without end plates
3288003	FIL AC 100 1/4 RMSA	3488003	FIL AC 200 1/4 RMSA	4488003	FIL AC 300 1/2 RMSA	6188003	FIL AC 400 1 RMSA
3388003	FIL AC 100 3/8 RMSA	3588003	FIL AC 200 3/8 RMSA	4588003	FIL AC 300 3/4 RMSA	6288003	FIL AC 400 1 1/4 RMSA
		3688003	FIL AC 200 1/2 RMSA	4688003	FIL AC 300 1 RMSA	6388003	FIL AC 400 1 1/2 RMSA
						6488003	FIL AC 400 2 RMSA

## DIAPHRAGM DRIER SERIES DRY 100



TECHNICAL DATA	DRY 100		FIL + DEP + PA + DRY 100	
	1/4"	3/8"	1/4"	3/8"
Threaded port				
Max. inlet pressure			1.3 MPa / 13 bar / 188 psi	
Suggested flow rate at 6.3 bar (0.63 MPa, 91 psi)	Nl/min	230	8	
	scfm	8	20	
Consumption of compressed air for regeneration at 6.3 bar	Nl/min	0.7	0.7	
	scfm	0.7	0.7	
Minimum temperature		2°C / 35°F	2°C / 35°F	
Maximum temperature at 1MPa; 10 bar; 145 psi		50°C / 122°F	50°C / 122°F	
Noise level	dB(A)	< 45	< 45	
Weight	kg	0.84	1.24	
Wall fixing screws		M4 x 50	M4 x 50	
Mounting position		In any position	Vertical	
Drain		-	RMSA: drain with manual condensate discharge and automatic discharge at zero pressure	
		-	SAC: automatic drain with condensate discharge. Operates by depression - requires variable air take-offs.	
Filter bowl and purification bowl capacity	cm <sup>3</sup>	-	22	
Fluid		Compressed air without condensate max solid particle size: 1 µm max oil residue: 0.01 mg/m <sup>3</sup>	Compressed air	
Important note		The drier must always be preceded by a 5 µm filter and a purifier		

### DRY 100

Code	Description
3290001A	DRY 100 without end plates
3290001	DRY 100 1/4"
3390001	DRY 100 3/8"

### FIL + DEP + PA + DRY 100

Code	Description
3291001	F + D + PA + DRY 100 1/4" RMSA-RMSA
3291005	F + D + PA + DRY 100 1/4" SAC-RMSA
3291006	F + D + PA + DRY 100 1/4" SAC-SAC
3391001	F + D + PA + DRY 100 3/8" RMSA-RMSA
3391005	F + D + PA + DRY 100 3/8" SAC-RMSA
3391006	F + D + PA + DRY 100 3/8" SAC-SAC

## REGULATORS



TECHNICAL DATA	REG 100		REG 200			REG 300			REG 400 PILOT OPERATED*			
	1/4"	3/8"	1/4"	3/8"	1/2"	1/2"	3/4"	1"	1"	1 1/4"	1 1/2"	2"
Threaded port	0 to 2 - 0 to 4 - 0 to 8 - 0 to 12											
Setting range	Depending on the pilot operated regulator											
Max. input pressure	bar	1.5	1.5	1.5	1.3	1.3	1.3	1.3	1.3	1.3	1.3	1.3
	MPa	15	15	15	13	13	13	13	13	13	13	13
	psi	217	217	217	188	188	188	188	188	188	188	188
Flow rate at 6.3 bar (0.63 MPa to 91 psi)	Nl/min	1100	2500	3500	7000	18000	20000	-	-	-	-	-
ΔP 0.5 bar (0.05 MPa to 7 psi)	scfm	39	88	124	247	363	707	-	-	-	-	-
Flow rate at 6.3 bar (0.63 MPa to 91 psi)	Nl/min	1600	3500	7000	-	-	-	-	-	-	-	-
ΔP 1 bar (0.1 MPa to 14 psi)	scfm	57	124	247	-	-	-	-	-	-	-	-
Max temperature at 1 MPa; 10 bar; 145 psi	°C	50	50	50	50	50	50	50	50	50	50	50
	°F	122	122	122	122	122	122	122	122	122	122	122
Weight	kg	0.4	0.7	1.4	4.8	5.6	-	-	-	-	-	-
Wall fixing screws		M4 x 50	M5 x 60	M5 x 70	M6 x 110	M6 x 110	M6 x 110	M6 x 110	M6 x 110	M6 x 110	M6 x 110	M6 x 110
Pressure gauge port		1/8"	1/8"	1/8"	1/8"	1/8"	1/8"	1/8"	1/8"	1/8"	1/8"	1/8"
Mounting position		In any position										
Fluid		Filtered lubricated or unlubricated compressed air. Lubrication, if used, must be continuous.										
Notes on use		The regulator pressure must always be set upwards. For increased sensitivity, use a pressure regulator with a rated pressure as close as possible to the required value. <b>Do not take air from pressure gauge ports.</b> <b>*Supplied without a pilot regulator.</b>										

Code	Description	Code	Description	Code	Description	Code	Description
<b>Skillair® 100 REGULATOR</b>		<b>Skillair® 200 REGULATOR</b>		<b>Skillair® 300 REGULATOR</b>		<b>Skillair® 400 REGULATOR</b>	
3202001A	REG 100 02 without end plates	3402001A	REG 200 02 without end plates	4402000A	REG 300 02 without end plates	6102001A	REG 400 without end plates
3202002A	REG 100 04 without end plates	3402002A	REG 200 04 without end plates	4402001A	REG 300 04 without end plates	6102001	REG 400 1
3202003A	REG 100 08 without end plates	3402003A	REG 200 08 without end plates	4402002A	REG 300 08 without end plates	6202001	REG 400 1 1/4
3202004A	REG 100 012 without end plates	3402004A	REG 200 012 without end plates	4402003A	REG 300 012 without end plates	6302001	REG 400 1 1/2
3202001	REG 100 1/4 02	3402001	REG 200 1/4 02	4402000	REG 300 1/2 02	6402001	REG 400 2
3202002	REG 100 1/4 04	3402002	REG 200 1/4 04	4402001	REG 300 1/2 04		
3202003	REG 100 1/4 08	3402003	REG 200 1/4 08	4402002	REG 300 1/2 08		
3202004	REG 100 1/4 012	3402004	REG 200 1/4 012	4402003	REG 300 1/2 012		
3302001	REG 100 3/8 02	3502001	REG 200 3/8 02	4502000	REG 300 3/4 02		
3302002	REG 100 3/8 04	3502002	REG 200 3/8 04	4502001	REG 300 3/4 04		
3302003	REG 100 3/8 08	3502003	REG 200 3/8 08	4502002	REG 300 3/4 08		
3302004	REG 100 3/8 012	3502004	REG 200 3/8 012	4502003	REG 300 3/4 012		
		3602001	REG 200 1/2 02	4602000	REG 300 1 02		
		3602002	REG 200 1/2 04	4602001	REG 300 1 04		
		3602003	REG 200 1/2 08	4602002	REG 300 1 08		
		3602004	REG 200 1/2 012	4602003	REG 300 1 012		

## PADLOCKABLE REGULATOR



Look at regulator for technical data

Code	Description	Code	Description	Code	Description
<b>Skillair® 100 PADLOCKABLE REGULATOR</b>		<b>Skillair® 200 PADLOCKABLE REGULATOR</b>		<b>Skillair® 300 PADLOCKABLE REGULATOR</b>	
3210001A	REG 100 KEY 02 without end plates	3410001A	REG 200 KEY 02 without end plates	4410000A	REG 300 KEY 02 without end plates
3210002A	REG 100 KEY 04 without end plates	3410002A	REG 200 KEY 04 without end plates	4410001A	REG 300 KEY 04 without end plates
3210003A	REG 100 KEY 08 without end plates	3410003A	REG 200 KEY 08 without end plates	4410002A	REG 300 KEY 08 without end plates
3210004A	REG 100 KEY 012 without end plates	3410004A	REG 200 KEY 012 without end plates	4410003A	REG 300 KEY 012 without end plates
3210001	REG 100 KEY 1/4 02	3410001	REG 200 KEY 1/4 02	4410000	REG 300 KEY 1/2 02
3210002	REG 100 KEY 1/4 04	3410002	REG 200 KEY 1/4 04	4410001	REG 300 KEY 1/2 04
3210003	REG 100 KEY 1/4 08	3410003	REG 200 KEY 1/4 08	4410002	REG 300 KEY 1/2 08
3210004	REG 100 KEY 1/4 012	3410004	REG 200 KEY 1/4 012	4410003	REG 300 KEY 1/2 012
3310001	REG 100 KEY 3/8 02	3510001	REG 200 KEY 3/8 02	4510000	REG 300 KEY 3/4 02
3310002	REG 100 KEY 3/8 04	3510002	REG 200 KEY 3/8 04	4510001	REG 300 KEY 3/4 04
3310003	REG 100 KEY 3/8 08	3510003	REG 200 KEY 3/8 08	4510002	REG 300 KEY 3/4 08
3310004	REG 100 KEY 3/8 012	3510004	REG 200 KEY 3/8 012	4510003	REG 300 KEY 3/4 012
		3610001	REG 200 KEY 1/2 02	4610000	REG 300 KEY 1 02
		3610002	REG 200 KEY 1/2 04	4610001	REG 300 KEY 1 04
		3610003	REG 200 KEY 1/2 08	4610002	REG 300 KEY 1 08
		3610004	REG 200 KEY 1/2 012	4610003	REG 300 KEY 1 012

## Skillair® 100 IN-SERIES REGULATOR



TECHNICAL DATA		
Threaded inlet port		1/4"
Threaded user port		G 1/8"
Degree of purification	bar	0 to 2 - 0 to 4 - 0 to 8 - 0 to 12
Max. input pressure		1.5 MPa - 15 bar - 217 psi
Flow rate at 6.3 bar (0.63 MPa to 91 psi)		500 Nl/min
ΔP 0.5 bar (0.05 MPa to 7 psi)		18 scfm
Flow rate at 6.3 bar (0.63 MPa to 91 psi)		950 Nl/min
ΔP 1 bar (0.1 MPa to 14 psi)		34 scfm
Fluid		Filtered, lubricated or unlubricated compressed air. Lubrication, if used, must be continuous
Max temperature at 1 MPa; 10 bar; 145 psi	°C	50
	°F	122
Weight	kg	0.4
Wall fixing screws		M4x50
Mounting position		In any position
Pressure gauge port		G 1/8"
Notes on use		The regulator pressure must always be set upwards. For increased sensitivity, use a pressure regulator with a rated pressure as close as possible to the required value.

Code	Description	Code	Description	Code	Description
<b>100 IN-SERIES REGULATOR</b>		<b>100 IN-SERIES REGULATOR</b>		<b>100 IN-SERIES REGULATOR</b>	
3202101A	100 IN-SERIES REG. 0-2 without end plates	3202101	100 IN-SERIES REG. 1/4 0-2	3302101	100 IN-SERIES REG. 3/8 0-2
3202102A	100 IN-SERIES REG. 0-4 without end plates	3202102	100 IN-SERIES REG. 1/4 0-4	3302102	100 IN-SERIES REG. 3/8 0-4
3202103A	100 IN-SERIES REG. 0-8 without end plates	3202103	100 IN-SERIES REG. 1/4 0-8	3302103	100 IN-SERIES REG. 3/8 0-8
3202104A	100 IN-SERIES REG. 0-12 without end plates	3202104	100 IN-SERIES REG. 1/4 0-12	3302104	100 IN-SERIES REG. 3/8 0-12

## PILOT REGULATOR



TECHNICAL DATA		PILOT REGULATOR
Threaded port		1/4"
Setting range	bar	0 to 2 - 0 to 4 - 0 to 8 - 0 to 12
Max. input pressure	MPa	1.3
	bar	13
	psi	188
Flow rate at 6.3 bar (0.63 MPa to 91 psi) ΔP 0.5 bar (0.05 MPa to 7 psi)		120 Nl/min - 4.3 scfm
Flow rate at 6.3 bar (0.63 MPa to 91 psi) ΔP 1 bar (0.1 MPa to 14 psi)		140 Nl/min - 5 scfm
Fluid		Filtered, lubricated or unlubricated compressed air. Lubrication, if used, must be continuous.
Max temperature at 1 MPa; 10 bar; 145 psi	°C	50
	°F	122
Weight	kg	0.6
Mounting position		In any position
Pressure gauge port		G 1/8"
Notes on use		The regulator pressure must always be set upwards. For increased sensitivity, use a pressure regulator with a rated pressure as close as possible to the required value. <b>Do not take air from the pressure gauge ports. Mount directly on REG 400.</b>

Code	Description	Code	Description
3206001	REG. P 1/4" 02	3206003	REG. P 1/4" 08
3206002	REG. P 1/4" 04	3206004	REG. P 1/4" 012

## PILOT PADLOCKABLE REGULATOR



Look at regulator for technical data

Code	Description	Code	Description
3208001	REG. P KEY 1/4" O2	3208003	REG. P KEY 1/4" O8
3208002	REG. P KEY 1/4" O4	3208004	REG. P KEY 1/4" O12

## FILTER REGULATOR



TECHNICAL DATA	FR 100		FR 200			FR 300		
	1/4"	3/8"	1/4"	3/8"	1/2"	1/2"	3/4"	1"
Threaded port			1/4"	3/8"	1/2"			
Setting range	bar 0 to 2 - 0 to 4 - 0 to 8 - 0 to 12		0 to 2 - 0 to 4 - 0 to 8 - 0 to 12			0 to 2 - 0 to 4 - 0 to 8 - 0 to 12		
Degree of filtration	µm 5 - 20 - 50		5 - 20 - 50			5 - 20 - 50		
Max. input pressure	1.5 MPa - 15 bar - 217 psi		1.3 MPa - 13 bar - 188 psi			1.3 MPa - 13 bar - 188 psi		
Flow rate at 6.3 bar (0.63 MPa to 91 psi)	Nl/min	1100	1600			3500		
ΔP 0.5 bar (0.05 MPa to 7psi)	scfm	39	57			125		
Flow rate at 6.3 bar (0.63 MPa to 91 psi)	Nl/min	1600	3000			5600		
ΔP 1 bar (0.1 MPa to 14 psi)	scfm	57	71			200		
Max temperature at: 1 MPa; 10 bar; 145 psi	°C	50	50			50		
	°F	122	122			122		
Weight	kg	0.5	1			1.8		
Wall fixing screws		M4 x 50	M5 x 60			M5 x 70		
Mounting position		Vertical	Vertical			Vertical		
Pressure gauge port		1/8"	1/8"			1/8"		
Bowl capacity	cm³	22	45			75		
Drain		RMSA - SAC	RMSA - SAC - RA			RMSA - RA		

RMSA: drain with manual condensate discharge and automatic discharge at zero pressure  
 RA: automatic drain with condensate discharge, independent of pressure and flow rate  
 Version conveys the draining by inserting the pipe having internal diameter 6 mm in the lower port.  
 SAC: automatic drain with condensate discharge. **Operates by depression - requires variable air take-offs.**  
 Filtered, lubricated or unlubricated compressed air. Lubrication, if used, must be continuous.

Notes on use  
 The regulator pressure must always be set upwards. For increased sensitivity, use a pressure regulator with a rated pressure as close as possible to the required value. **Do not take air from pressure gauge ports.**  
**The maximum inlet pressure for the version with RA automatic condensate drainage must not exceed 10 bar.**

Code	Description	Code	Description	Code	Description	Code	Description
<b>Skillair® 100 FILTER REGULATOR</b>							
3283007A	FR 100 5 08 RMSA without end plates	3383034	FR 100 3/8 5 012 SAC	3583031	FR 200 3/8 5 08 SAC	4483007	FR 300 1/2 5 012 RMSA
3283008A	FR 100 20 08 RMSA without end plates	3383035	FR 100 3/8 20 012 SAC	3583032	FR 200 3/8 20 08 SAC	4483008	FR 300 1/2 20 012 RMSA
3283009A	FR 100 50 08 RMSA without end plates	3383036	FR 100 3/8 50 012 SAC	3583033	FR 200 3/8 50 08 SAC	4483009	FR 300 1/2 50 012 RMSA
3283010A	FR 100 5 012 RMSA without end plates	<b>Skillair® 200 FILTER REGULATOR</b>		3583034	FR 200 3/8 5 012 SAC	4483013	FR 300 1/2 5 08 RA
3283011A	FR 100 20 012 RMSA without end plates	3483007A	FR 200 5 08 RMSA without end plates	3583035	FR 200 3/8 20 012 SAC	4483014	FR 300 1/2 20 08 RA
3283012A	FR 100 50 012 RMSA without end plates	3483008A	FR 200 20 08 RMSA without end plates	3583036	FR 200 3/8 50 012 SAC	4483015	FR 300 1/2 50 08 RA
3283031A	FR 100 5 08 SAC without end plates	3483009A	FR 200 50 08 RMSA without end plates	3683007	FR 200 1/2 5 08 RMSA	4483016	FR 300 1/2 5 012 RA
3283032A	FR 100 20 08 SAC without end plates	3483010A	FR 200 5 012 RMSA without end plates	3683008	FR 200 1/2 20 08 RMSA	4483017	FR 300 1/2 20 012 RA
3283033A	FR 100 50 08 SAC without end plates	3483011A	FR 200 20 012 RMSA without end plates	3683009	FR 200 1/2 50 08 RMSA	4483018	FR 300 1/2 50 012 RA
3283034A	FR 100 5 012 SAC without end plates	3483012A	FR 200 50 012 RMSA without end plates	3683010	FR 200 1/2 5 012 RMSA	4583004	FR 300 3/4 5 08 RMSA
3283035A	FR 100 20 012 SAC without end plates	3483031A	FR 200 5 08 SAC without end plates	3683011	FR 200 1/2 20 012 RMSA	4583005	FR 300 3/4 20 08 RMSA
3283036A	FR 100 50 012 SAC without end plates	3483032A	FR 200 20 08 SAC without end plates	3683012	FR 200 1/2 50 012 RMSA	4583006	FR 300 3/4 50 08 RMSA
3283007	FR 100 1/4 5 08 RMSA	3483033A	FR 200 50 08 SAC without end plates	3683031	FR 200 1/2 5 08 SAC	4583007	FR 300 3/4 5 012 RMSA
3283008	FR 100 1/4 20 08 RMSA	3483034A	FR 200 5 012 SAC without end plates	3683032	FR 200 1/2 20 08 SAC	4583008	FR 300 3/4 20 012 RMSA
3283009	FR 100 1/4 50 08 RMSA	3483035A	FR 200 20 012 SAC without end plates	3683033	FR 200 1/2 50 08 SAC	4583009	FR 300 3/4 50 012 RMSA
3283010	FR 100 1/4 5 012 RMSA	3483036A	FR 200 50 012 SAC without end plates	3683034	FR 200 1/2 5 012 SAC	4583013	FR 300 3/4 5 08 RA
3283011	FR 100 1/4 20 012 RMSA	3483007	FR 200 1/4 5 08 RMSA	3683035	FR 200 1/2 20 012 SAC	4583014	FR 300 3/4 20 08 RA
3283012	FR 100 1/4 50 012 RMSA	3483008	FR 200 1/4 20 08 RMSA	3683036	FR 200 1/2 50 012 SAC	4583015	FR 300 3/4 50 08 RA
3283031	FR 100 1/4 5 08 SAC	3483009	FR 200 1/4 50 08 RMSA	<b>Skillair® 300 FILTER REGULATOR</b>			
3283032	FR 100 1/4 20 08 SAC	3483010	FR 200 1/4 5 012 RMSA	4483004A	FR 300 5 08 RMSA without end plates	4583017	FR 300 3/4 20 012 RA
3283033	FR 100 1/4 50 08 SAC	3483011	FR 200 1/4 20 012 RMSA	4483005A	FR 300 20 08 RMSA without end plates	4583018	FR 300 3/4 50 012 RA
3283034	FR 100 1/4 5 012 SAC	3483012	FR 200 1/4 50 012 RMSA	4483006A	FR 300 50 08 RMSA without end plates	4683004	FR 300 1 5 08 RMSA
3283035	FR 100 1/4 20 012 SAC	3483031	FR 200 1/4 5 08 SAC	4483007A	FR 300 5 012 RMSA without end plates	4683005	FR 300 1 20 08 RMSA
3283036	FR 100 1/4 50 012 SAC	3483032	FR 200 1/4 20 08 SAC	4483008A	FR 300 20 012 RMSA without end plates	4683006	FR 300 1 50 08 RMSA
3383007	FR 100 3/8 5 08 RMSA	3483033	FR 200 1/4 50 08 SAC	4483009A	FR 300 50 012 RMSA without end plates	4683007	FR 300 1 5 012 RMSA
3383008	FR 100 3/8 20 08 RMSA	3483034	FR 200 1/4 5 012 SAC	4483013A	FR 300 5 08 RA without end plates	4683008	FR 300 1 20 012 RMSA
3383009	FR 100 3/8 50 08 RMSA	3483035	FR 200 1/4 20 012 SAC	4483014A	FR 300 20 08 RA without end plates	4683009	FR 300 1 50 012 RMSA
3383010	FR 100 3/8 5 012 RMSA	3483036	FR 200 1/4 50 012 SAC	4483015A	FR 300 50 08 RA without end plates	4683013	FR 300 1 5 08 RA
3383011	FR 100 3/8 20 012 RMSA	3583007	FR 200 3/8 5 08 RMSA	4483016A	FR 300 5 012 RA without end plates	4683014	FR 300 1 20 08 RA
3383012	FR 100 3/8 50 012 RMSA	3583008	FR 200 3/8 20 08 RMSA	4483017A	FR 300 20 012 RA without end plates	4683015	FR 300 1 50 08 RA
3383031	FR 100 3/8 5 08 SAC	3583009	FR 200 3/8 50 08 RMSA	4483018A	FR 300 50 012 RA without end plates	4683016	FR 300 1 5 012 RA
3383032	FR 100 3/8 20 08 SAC	3583010	FR 200 3/8 5 012 RMSA	4483004	FR 300 1/2 5 08 RMSA	4683017	FR 300 1 20 012 RA
3383033	FR 100 3/8 50 08 SAC	3583011	FR 200 3/8 20 012 RMSA	4483005	FR 300 1/2 20 08 RMSA	4683018	FR 300 1 50 012 RA
		3583012	FR 200 3/8 50 012 RMSA	4483006	FR 300 1/2 50 08 RMSA		

## Skillair® 300 PILOT OPERATED REGULATOR



TECHNICAL DATA	300 PILOT OPERATED REG		
	1/2"	3/4"	1"
Threaded port	Depending on the pilot regulator		
Setting range	Depending on the pilot regulator		
Max. input pressure	MPa	1.3	
	bar	13	
	psi	188	
Flow rate at 6.3 bar (0.63 MPa to 91 psi) ΔP 0.5 bar (0.05 MPa to 7 psi)	Nl/min	4500	
	scfm	160	
Flow rate at 6.3 bar (0.63 MPa to 91 psi) ΔP 1 bar (0.1 MPa to 14 psi)	Nl/min	7000	
	scfm	247	
Fluid	Filtered, lubricated or unlubricated compressed air. Lubrication, if used, must be continuous.		
Max temperature at 1 MPa; 10 bar; 145 psi	°C	50	
	°F	122	
Weight	kg	1.3	
Wall fixing screws	M5 x 70		
Mounting position	In any position		
Pressure gauge port	1/8"		
Notes on use	The regulator pressure must always be set upwards. <b>Do not take air from the pressure gauge ports.</b>		

Code	Description	Code	Description
4403003A	300 PILOT OPERATED REG without end plates	4503003	300 3/4" PILOT OPERATED REG
4403003	300 1/2" PILOT OPERATED REG	4603003	300 1" PILOT OPERATED REG

## LUBRICATOR



TECHNICAL DATA	LUB 100		LUB 200			LUB 300			LUB 400			
	1/4"	3/8"	1/4"	3/8"	1/2"	1/2"	3/4"	1"	1"	1 1/4"	1 1/2"	2"
Threaded port	Mist											
Type of lubrication	Mist											
Bowl capacity	cm <sup>3</sup>		50			160			800			
Versions	Standard - CD		Standard - CD			Standard - CD - ML CD			Standard - CD - ML CD			
Max. inlet pressure	Mpa	1.5	1.3		1.3			1.3		1.3		1.3
	bar	15	13		13			13		13		13
	psi	217	188		188			188		188		188
Flow rate at 6.3 bar (0.63 MPa to 91 psi)	Nl/min	1100	2200			3500			18000		21000	
ΔP 0.5 bar (0.05 MPa to 7 psi)	scfm	39	71			125			640		750	
Flow rate at 6.3 bar (0.63 MPa to 91 psi)	Nl/min	1500	3700			5500			-		-	
ΔP 1 bar (0.1 MPa to 14 psi)	scfm	53	131			196			-		-	
Max temperature at: 1 MPa; 10 bar; 145 psi	°C	50	50			50			50		50	
	°F	122	122			122			122		122	
Weight	kg	0.4	0.7		1.4			4.9		5.7		
Wall fixing screws	M4 x 50		M5 x 60			M5 x 70			M6 x 110		M6 x 110	
Mounting position	Vertical											
Fluid	Filtered compressed air											
Recommended oils	ISO and UNI FD22 (Energol HPL to Spinesso to Mobil DTE to Tellus Oil).											
Notes on use	Install the lubricator as close as possible to the point of use. Fill the lubricator bowl with oil before pressurizing the system. <b>Do not use cleaning oils, brake fluid oils or solvents in general.</b> For the best lubrication results, set the drip rate to one drop per 300-600 NL.											

Code	Description	Code	Description	Code	Description	Code	Description
<b>Skillair® 100 LUBRICATOR</b>		<b>Skillair® 200 LUBRICATOR</b>		<b>Skillair® 300 LUBRICATOR</b>		<b>Skillair® 400 LUBRICATOR</b>	
3281001A	LUB 100 without end plates	3481001A	LUB 200 without end plates	4481001A	LUB 300 without end plates	6181001A	LUB 400 without end plates
3281005A	LUB 100 CD manual without end plates	3481005A	LUB 200 CD manual without end plates	4481005A	LUB 300 CD manual without end plates	6181004A	LUB 400 CD manual without end plates
3281001	LUB 100 1/4	3481001	LUB 200 1/4	4481006A	LUB 300 ML-CD autom. without end plates	6181006A	LUB 400 ML-CD autom. without end plates
3281005	LUB 100 1/4 CD manual	3481005	LUB 200 1/4 CD manual	4481001	LUB 300 1/2	6181001	LUB 400 1
3381001	LUB 100 3/8	3581001	LUB 200 3/8	4481005	LUB 300 1/2 CD manual	6181004	LUB 400 1 CD manual
3381005	LUB 100 3/8 CD manual	3581005	LUB 200 3/8 CD manual	4481006	LUB 300 1/2 ML-CD automatic	6181006	LUB 400 1 ML-CD automatic
		3681001	LUB 200 1/2	4581001	LUB 300 3/4	6281001	LUB 400 1 1/4
		3681005	LUB 200 1/2 CD manual	4581005	LUB 300 3/4 CD manual	6281004	LUB 400 1 1/4 CD manual
				4581006	LUB 300 3/4 ML-CD automatic	6281006	LUB 400 1 1/4 ML-CD automatic
				4681001	LUB 300 1	6381001	LUB 400 1 1/2
				4681005	LUB 300 1 CD manual	6381004	LUB 400 1 1/2 CD manual
				4681006	LUB 300 1 ML-CD automatic	6381006	LUB 400 1 1/2 ML-CD automatic
						6481001	LUB 400 2
						6481004	LUB 400 2 CD manual
						6481006	LUB 400 2 ML-CD automatic

STD: Standard version filled with oil by removing the bowl or through the top cap. Requires circuit relieving.  
ML CD: Depression filling with minimum leveland valve  
CD MANUAL: Filling by depression.



## SHUT-OFF VALVE



TECHNICAL DATA		V3V 100		V3V 200			V3V 300			V3V 400			
Threaded port		1/4"	3/8"	1/4"	3/8"	1/2"	1/2"	3/4"	1"	1"	1 1/4"	1 1/2"	2"
Min. inlet pressure for solenoid version **	MPa	0.3		0.3			0.2			0.3			0.3
	bar	3		3			2			3			3
	psi	43.5		43.5			29			43.5			43.5
Max. input pressure*	MPa	1.5		1.3			1.3			1.3			1.3
	bar	15		13			13			13			13
	psi	217		188			188			188			188
Flow rate at 6.3 bar (0.63 MPa to 91 psi)	NI/min	1300		2400			3200			13000			14000
	scfm	46		85			113			460			494
Flow rate at 6.3 bar (0.63 MPa to 91 psi)	NI/min	1650		3000			4700			-			-
	scfm	58		106			166			-			-
Max temperature	°C	50		50			50			50			50
	°F	122		122			122			122			122
Weight	kg	~ 0.5		~ 0.8			~ 1.2			4.8			5.6
Wall fixing screws		M4 x 50		M5 x 60			M5 x 70			M6 x 110			M6 x 110
Type of control		Manual - Pneumatic - Solenoid						Manual - Pneumatic - Solenoid					
		Solenoid pilot-assisted						Solenoid pilot-assisted - Key-operated					
Mounting position		In any position.											
Fluid		Filtered, lubricated or unlubricated compressed air. Lubrication, if used, must be continuous.											
Note		* 1 MPa - 10 bar - 145 psi for solenoid version											
		** 0.01 MPa - 0.1 bar - 1.45 psi for manual, pneumatic and pilot-assisted versions with controls min. 0.3 MPa 3 bar 43.5 psi.											

Code	Description
<b>Skillair® 100 3-WAY VALVE</b>	
3270001A	V3V 100 lockable without end plates
3269000A	V3V 100 pneumatic without end plates
3269001A	V3V 100 solenoid without end plates
3269002A	V3V 100 sol. pilot assisted without end plates
3270001	V3V 100 1/4 lockable
3269000	V3V 100 1/4 pneumatic
3269001	V3V 100 1/4 solenoid
3269002	V3V 100 1/4 solenoid pilot assisted
3370001	V3V 100 3/8 lockable
3369000	V3V 100 3/8 pneumatic
3369001	V3V 100 3/8 solenoid
3369002	V3V 100 3/8 solenoid pilot assisted

Code	Description
<b>Skillair® 200 3-WAY VALVE</b>	
3470001A	V3V 200 lockable without end plates
3469000A	V3V 200 pneumatic without end plates
3469001A	V3V 200 solenoid without end plates
3469002A	V3V 200 sol. pilot assisted without end plates
3469004A	V3V 200 solenoid cno comm. w/end plate
3469005A	V3V 200 sol. cno comm. ass. comm. w/end plate
3470001	V3V 200 1/4 lockable
3469000	V3V 200 1/4 pneumatic
3469001	V3V 200 1/4 solenoid
3469002	V3V 200 1/4 solenoid pilot assisted
3469004	V3V 200 1/4 solenoid cno comm.
3469005	V3V 200 1/4 solenoid cno comm. pilot-assisted
3570001	V3V 200 3/8 lockable
3569000	V3V 200 3/8 pneumatic
3569001	V3V 200 3/8 solenoid
3569002	V3V 200 3/8 solenoid pilot assisted
3569004	V3V 200 3/8 solenoid cno comm.
3569005	V3V 200 3/8 solenoid cno comm. pilot-assisted
3670001	V3V 200 1/2 lockable
3669000	V3V 200 1/2 pneumatic
3669001	V3V 200 1/2 solenoid
3669002	V3V 200 1/2 solenoid pilot assisted
3669004	V3V 200 1/2 solenoid cno comm.
3669005	V3V 200 1/2 solenoid cno comm. pilot-assisted

Code	Description
<b>Skillair® 300 3-WAY VALVE</b>	
4470001A	V3V 300 lockable without end plates
4469000A	V3V 300 pneumatic without end plates
4469004A	V3V 300 solenoid cno without end plates
4469005A	V3V 300 sol. cno pilot-assisted w/end plates
4470001	V3V 300 1/2 lockable
4469000	V3V 300 1/2 pneumatic
4469004	V3V 300 1/2 solenoid cno
4469005	V3V 300 1/2 solenoid cno assisted
4570001	V3V 300 3/4 lockable
4569000	V3V 300 3/4 pneumatic
4569004	V3V 300 3/4 solenoid cno
4569005	V3V 300 3/4 solenoid cno assisted
4669000	V3V 300 1 pneumatic
4669004	V3V 300 1 solenoid cno
4669005	V3V 300 1 solenoid cno assisted
4670001	V3V 300 1 lockable

Code	Description
<b>Skillair® 400 3-WAY VALVE</b>	
6169010A	V3V 400 key-operated without end plates
6169000A	V3V 400 pneumatic without end plates
6169004A	V3V 400 solenoid cno without end plates
6169005A	V3V 400 sol. cno pilot-assisted w/end plates
6170002A	V3V 400 lockable without end plates
6169010	V3V 400 1 key-operated
6169000	V3V 400 1 pneumatic
6169004	V3V 400 1 solenoid cno
6169005	V3V 400 1 solenoid cno assisted
6269010	V3V 400 1 1/4 key-operated
6269000	V3V 400 1 1/4 pneumatic
6269004	V3V 400 1 1/4 solenoid cno
6269005	V3V 400 1 1/4 solenoid cno assisted
6369010	V3V 400 1 1/2 key-operated
6369000	V3V 400 1 1/2 pneumatic
6369004	V3V 400 1 1/2 solenoid cno
6369005	V3V 400 1 1/2 solenoid cno assisted
6469010	V3V 400 2 key-operated
6469000	V3V 400 2 pneumatic
6469004	V3V 400 2 solenoid cno
6469005	V3V 400 2 solenoid cno assisted
6170002	V3V 400 1 lockable
6270002	V3V 400 1 1/4 lockable
6370002	V3V 400 1 1/2 lockable
6470002	V3V 400 2 lockable

## SUB-BASE AND ADAPTER BASE



Code	Description
<b>MULTIPLE SUB-BASES FOR REGULATORS</b>	
9200202	ACC. SB 2 100
9300202	ACC. SB 2 200
9400202	ACC. SB 2 300
9200302	ACC. SB 3 100
9300302	ACC. SB 3 200
9400302	ACC. SB 3 300

Code	Description
<b>ADAPTER BASE</b>	
9201801	BA 100
9321801	BA 200
9401801	BA 300

Code	Description
<b>SIZE ADAPTER</b>	
9301801	BA 100 - 200
9301802	BA 100 - 300
9301803	BA 200 - 300



## PROGRESSIVE START VALVE



TECHNICAL DATA		VAP 100	
		1/4"	3/8"
Threaded port			
Min. inlet pressure **	MPa	0.3	
	bar	3	
	psi	43.5	
Max. inlet pressure*	MPa	1.5	
	bar	15	
	psi	217	
Flow rate at 6 bar (0.6 MPa to 87 psi) ΔP 0.5 bar (0.05 MPa to 7 psi)	Nl/min	1300	
	scfm	46	
Flow rate at 6 bar (0.6 MPa to 87 psi) ΔP 1 bar (0.1 MPa to 14 psi)	Nl/min	2000	
	scfm	71	
Max temperature	°C	50	
	°F	122	
Weight	kg	0.5 ~	
Wall fixing screws		M4 x 50	
Mounting position		In any position	
Type of control		Automatic - Pneumatic - Solenoid - Solenoid pilot-assisted	
Fluid		Filtered, lubricated or unlubricated compressed air. Lubrication, if used, must be continuous	
** 0.01 MPa - 0.1 bar - 1.45 psi for pneumatic and pilot-assisted versions with controls at min. 0.3 MPa 3 bar 43.5 psi.			
* 1 MPa - 10 bar - 145 psi			

Code	Description
3271000A	VAP 100 without end plates
3271500A	VAP 100 pneumatic without end plates
3271600A	VAP 100 solenoid without end plates
3271700A	VAP 100 solenoid pilot-assisted without end plates
3271000	VAP 100 1/4
3271500	VAP 100 1/4 pneumatic

Code	Description
3271600	VAP 100 1/4 solenoid
3271700	VAP 100 1/4 solenoid pilot-assisted
3371000	VAP 100 3/8
3371500	VAP 100 3/8 pneumatic
3371600	VAP 100 3/8 solenoid
3371700	VAP 100 3/8 solenoid pilot-assisted

## AIR TAKE-OFF



TECHNICAL DATA	PA 100		PA 200			PA 300			PA 400			
	1/4"	3/8"	1/4"	3/8"	1/2"	1/2"	3/4"	1"	1"	1 1/4"	1 1/2"	2"
Threaded port												
Max. working temperature	°C	50	50	50	50	50	50	50	50	50	50	50
at: 1 MPa; 10 bar; 145 psi	°F	122	122	122	122	122	122	122	122	122	122	122
Max. operating pressure	MPa	1.5	1.3	1.3	1.3	1.3	1.3	1.3	1.3	1.3	1.3	1.3
	bar	15	13	13	13	13	13	13	13	13	13	13
	psi	217	188	188	188	188	188	188	188	188	188	188
Wall fixing screws		M4 x 50	M5 x 60	M5 x 60	M5 x 70	M5 x 70	M5 x 70	M5 x 70	M6 x 110	M6 x 110	M6 x 110	M6 x 110
Threaded port		1/4"	1/4"	1/4"	3/8"	3/8"	3/8"	3/8"	1"	1"	1"	1"
Weight	kg	0.3	0.5	0.5	0.8	0.8	0.8	0.8	4.3	4.3	4.3	5.1

Code	Description
<b>Skillair® 100 AIR TAKE-OFF</b>	
9200402A	PA 100 without end plates
9200402	PA 100 1/4
9300401	PA 100 3/8

Code	Description
<b>Skillair® 200 AIR TAKE-OFF</b>	
9300402A	PA 200 without end plates
9300404	PA 200 1/2
9300402	PA 200 1/4
9300403	PA 200 3/8

Code	Description
<b>Skillair® 300 AIR TAKE-OFF</b>	
9400402A	PA 300 without end plates
9500402	PA 300 1
9400402	PA 300 1/2
9500401	PA 300 3/4

Code	Description
<b>Skillair® 400 AIR TAKE-OFF</b>	
9700401A	PA 400 without end plates
9700401	PA 400 1
9700403	PA 400 1 1/2
9700402	PA 400 1 1/4
9700404	PA 400 2

## PROGRESSIVE STARTER



TECHNICAL DATA	APR 100		APR 200			APR 300			APR 400			
		1/4"   3/8"	1/4"   3/8"	1/2"	1/2"	3/4"	1"	1"	1 1/4"	1 1/2"	2"	
Threaded port												
Min. inlet pressure	MPa	0.3	0.3	0.3	0.4	0.3	0.3	0.3	0.3	0.3	0.3	
	bar	3	3	3	4	3	3	3	3	3		
	psi	43.5	43.5	43.5	58	43.5	43.5	43.5	43.5	43.5		
Max. inlet pressure*	MPa	1.5	1.3	1.3	1.3	1	1	1	1	1		
	bar	15	13	13	13	10	10	10	10	10		
	psi	217	188.5	188.5	188.5	145	145	145	145	145		
Flow rate at 6.3 bar (0.63 MPa to 91 psi)	Nl/min	1300	2000	2400	13000	14000						
ΔP 0.5 bar (0.05 MPa to 7 psi)	scfm	46	71	85	460	494						
Flow rate at 6.3 bar (0.63 MPa to 91 psi)	Nl/min	2000	3200	3600	-	-						
ΔP 1 bar (0.1 MPa to 14 psi)	scfm	71	113	127	-	-						
Max temperature	°C	50	50	50	50	50						
	°F	122	122	122	122	122						
Weight	kg	~ 0.8	~ 0.9	~ 1.5	5.6	6.4						
Wall fixing screws		M4 x 50	M5 x 60	M5 x 70	M6 x 110	M6 x 110						
Type of control		Pneumatic Solenoid	Pneumatic Solenoid	Pneumatic Solenoid	Pneumatic Solenoid	Pneumatic - Solenoid						
Mounting position		In any position										
Fluid		Filtered, lubricated or unlubricated compressed air. Lubrication, if used, must be continuous.										
Notes on use		For the pneumatic version 200 the pilot pressure must range between the inlet P and the inlet P + 2 bar. For pneumatic version 300, the pilot pressure must be greater or equal to the input pressure. * 1 MPa - 10 bar - 145 psi for solenoid version										

Code	Description	Code	Description	Code	Description	Code	Description
<b>3267001A</b>	<b>APR 100 pneumatic without end plates</b>	<b>3471000A</b>	<b>APR 200 pneumatic without end plates</b>	<b>4471900A</b>	<b>APR 300 pneumatic without end plates</b>	<b>6171002A</b>	<b>APR 400 pneumatic without end plates</b>
<b>3267051A</b>	<b>APR 100 solenoid without end plates</b>	<b>3471001A</b>	<b>APR 200 solenoid without end plates</b>	<b>4471901A</b>	<b>APR 300 solen. cnomo without end plates</b>	<b>6171003A</b>	<b>APR 400 solenoid without end plates</b>
<b>3267001</b>	<b>APR 100 1/4 pneumatic</b>	<b>3471004A</b>	<b>APR 200 solen. cnomo without end plates</b>	<b>4471900</b>	<b>APR 300 1/2 pneumatic</b>	<b>6171002</b>	<b>APR 400 1 pneumatic</b>
<b>3267051</b>	<b>APR 100 1/4 solenoid</b>	<b>3471000</b>	<b>APR 200 1/4 pneumatic</b>	<b>4471901</b>	<b>APR 300 1/2 solenoid cnomo control</b>	<b>6171003</b>	<b>APR 400 1 solenoid</b>
<b>3367001</b>	<b>APR 100 3/8 pneumatic</b>	<b>3471001</b>	<b>APR 200 1/4 solenoid</b>	<b>4571900</b>	<b>APR 300 3/4 pneumatic</b>	<b>6271002</b>	<b>APR 400 1 1/4 pneumatic</b>
<b>3367051</b>	<b>APR 100 3/8 solenoid</b>	<b>3471004</b>	<b>APR 200 1/4 solenoid cnomo control</b>	<b>4571901</b>	<b>APR 300 3/4 solenoid cnomo control</b>	<b>6271003</b>	<b>APR 400 1 1/4 solenoid</b>
		<b>3571000</b>	<b>APR 200 3/8 pneumatic</b>	<b>4671900</b>	<b>APR 300 1 pneumatic</b>	<b>6371002</b>	<b>APR 400 1 1/2 pneumatic</b>
		<b>3571001</b>	<b>APR 200 3/8 solenoid</b>	<b>4671901</b>	<b>APR 300 1 solenoid cnomo control</b>	<b>6371003</b>	<b>APR 400 1 1/2 solenoid</b>
		<b>3571004</b>	<b>APR 200 3/8 solenoid cnomo control</b>			<b>6471002</b>	<b>APR 400 2 pneumatic</b>
		<b>3671000</b>	<b>APR 200 1/2 pneumatic</b>			<b>6471003</b>	<b>APR 400 2 solenoid</b>
		<b>3671001</b>	<b>APR 200 1/2 solenoid</b>				
		<b>3671004</b>	<b>APR 200 1/2 solenoid cnomo control</b>				

## PRESSURE SWITCHES

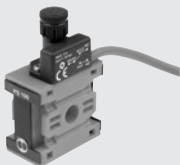

TECHNICAL DATA		PS 100		PS 200		PS 300	
Adjustable pressure interval	bar			0.5 to 10			
Hysteresis (not adjustable)	bar			from 0.4 to 0.8			
Maximum pressure	bar	15		13		13	
	MPa	1.5		1.3		1.3	
	psi	217		188		188	
Operating temperature range at: 1 MPa; 10 bar; 145 psi	°C			-10 to 50			
	°F			14 to 122			
Lower threaded port		1/4"		1/4"		3/8"	
Maximum current	A			2			
Maximum voltage	V			250			
Outside diameter of cable	mm			4.9			
Number of wires and cross section				3 x 0.5 mm <sup>2</sup>			
Contacts				Normally-Open (NO) and Normally-Closed (NC)			
Protection				IP65			
Number of switchings				5 x 10 <sup>6</sup>			
Fluid		Filtered lubricated or unlubricated compressed air. Lubrication, if used, must be continuous.					
Mounting position		In any position.					
Weight	kg	0.160		0.185		0.250	

Code	Description	Code	Description	Code	Description
<b>3240000A</b>	<b>PS 100 2A NO/NC 2 m cable without end plates</b>	<b>3440000A</b>	<b>PS 200 2A NO/NC 2 m cable without end plates</b>	<b>4440000A</b>	<b>PS 300 2A NO/NC 2 m cable without end plates</b>
<b>3240001A</b>	<b>PS 100 2A NO/NC M8 connector without end plates</b>	<b>3440001A</b>	<b>PS 200 2A NO/NC M8 connector without end plates</b>	<b>4440001A</b>	<b>PS 300 2A NO/NC M8 connector without end plates</b>

## FIL+REG+LUB



Code	Description
<b>FIL+REG+LUB Skillair® 100</b>	
3282008	FRL 100 1/4 20 08 RMSA
3282011	FRL 100 1/4 20 012 RMSA
3382008	FRL 100 3/8 20 08 RMSA
3382011	FRL 100 3/8 20 012 RMSA
<b>FIL+REG+LUB Skillair® 200</b>	
3482008	FRL 200 1/4 20 08 RMSA
3482011	FRL 200 1/4 20 012 RMSA
3582008	FRL 200 3/8 20 08 RMSA
3582011	FRL 200 3/8 20 012 RMSA
3682008	FRL 200 1/2 20 08 RMSA
3682011	FRL 200 1/2 20 012 RMSA

Code	Description
<b>FIL+REG+LUB Skillair® 300</b>	
4482005	FRL 300 1/2 20 08 RMSA
4482008	FRL 300 1/2 20 012 RMSA
4582005	FRL 300 3/4 20 08 RMSA
4582008	FRL 300 3/4 20 012 RMSA
4682005	FRL 300 1 20 08 RMSA
4682008	FRL 300 1 20 012 RMSA
<b>FIL+REG+LUB Skillair® 400</b>	
6182002	FRL 400 1 20 RMSA
6182005	FRL 400 1 20 RA
6282002	FRL 400 1 1/4 20 RMSA
6382002	FRL 400 1 1/2 20 RMSA
6482002	FRL 400 2 20 RMSA
4682008	FRL 300 1 20 012 RMSA

The following versions are available on request:  
 - with 5 µm or 50 µm degree of filtration  
 - with SAC or RA condensate discharge

## FIL+LUB



Code	Description
<b>F+L Skillair® 100</b>	
3285002	F+L 100 1/4 20 RMSA
3385002	F+L 100 3/8 20 RMSA
<b>F+L Skillair® 200</b>	
3485002	F+L 200 1/4 20 RMSA
3585002	F+L 200 3/8 20 RMSA
3685002	F+L 200 1/2 20 RMSA

Code	Description
<b>F+L Skillair® 300</b>	
4485002	F+L 300 1/2 20 RMSA
4585002	F+L 300 3/4 20 RMSA
4585005	F+L 300 3/4 20 RA
4685002	F+L 300 1 20 RMSA
<b>F+L Skillair® 400</b>	
6185002	F+L 400 1 20 RMSA
6185005	F+L 400 1 20 RA
6285002	F+L 400 1 1/4 20 RMSA
6385002	F+L 400 1 1/2 20 RMSA
6485002	F+L 400 2 20 RMSA

The following versions are available on request:  
 - with 5 µm or 50 µm degree of filtration  
 - with SAC or RA condensate discharge

## FR+LUB



Code	Description
<b>FR+L Skillair® 100</b>	
3284008	FR+L 100 1/4 20 08 RMSA
3284011	FR+L 100 1/4 20 012 RMSA
3384008	FR+L 100 3/8 20 08 RMSA
3384011	FR+L 100 3/8 20 012 RMSA
<b>FR+L Skillair® 200</b>	
3484008	FR+L 200 1/4 20 08 RMSA
3484011	FR+L 200 1/4 20 012 RMSA
3584008	FR+L 200 3/8 20 08 RMSA
3584011	FR+L 200 3/8 20 012 RMSA
3684008	FR+L 200 1/2 20 08 RMSA
3684011	FR+L 200 1/2 20 012 RMSA

Code	Description
<b>FR+L Skillair® 300</b>	
4484005	FR+L 300 1/2 20 08 RMSA
4484008	FR+L 300 1/2 20 012 RMSA
4584005	FR+L 300 3/4 20 08 RMSA
4584008	FR+L 300 3/4 20 012 RMSA
4684005	FR+L 300 1 20 08 RMSA
4684008	FR+L 300 1 20 012 RMSA

The following versions are available on request:  
 - with 5 µm or 50 µm degree of filtration  
 - with SAC or RA condensate discharge

## FIL+DEP



Code	Description
<b>F+D Skillair® 100</b>	
3289001	F+D 100 1/4 5 RMSA-RMSA
3289005	F+D 100 1/4 5 SAC-RMSA
3289006	F+D 100 1/4 5 SAC-SAC
3389001	F+D 100 3/8 5 RMSA-RMSA
3389005	F+D 100 3/8 5 SAC-RMSA
3389006	F+D 100 3/8 5 SAC-SAC
<b>F+D Skillair® 200</b>	
3489001	F+D 200 1/4 5 RMSA-RMSA
3489005	F+D 200 1/4 5 SAC-RMSA
3489006	F+D 200 1/4 5 SAC-SAC
3589001	F+D 200 3/8 5 RMSA-RMSA
3589005	F+D 200 3/8 5 SAC-RMSA
3589006	F+D 200 3/8 5 SAC-SAC
3689001	F+D 200 1/2 5 RMSA-RMSA
3689005	F+D 200 1/2 5 SAC-RMSA
3689006	F+D 200 1/2 5 SAC-SAC

Code	Description
<b>F+D Skillair® 300</b>	
4489001	F+D 300 1/2 5 RMSA-RMSA
4489002	F+D 300 1/2 5 RA-RA
4589001	F+D 300 3/4 5 RMSA-RMSA
4589002	F+D 300 3/4 5 RA-RA
4689001	F+D 300 1 5 RMSA-RMSA
4689002	F+D 300 1 5 RA-RA
<b>F+D Skillair® 400</b>	
6189001	F+D 400 1 5 RMSA-RMSA
6189002	F+D 400 1 5 RA-RA
6289001	F+D 400 1 1/4 5 RMSA-RMSA
6289002	F+D 400 1 1/4 5 RA-RA
6389001	F+D 400 1 1/2 5 RMSA-RMSA
6389002	F+D 400 1 1/2 5 RA-RA
6489001	F+D 400 2 5 RMSA-RMSA
6489002	F+D 400 2 5 RA-RA

## V3V+FR+LUB



### ORDERING CODES

Code	Description
<b>VFR+L Skillair® 100</b>	
3272008	VFR+L 100 1/4 20 08 RMSA
3272011	VFR+L 100 1/4 20 012 RMSA
3372008	VFR+L 100 3/8 20 08 RMSA
3372011	VFR+L 100 3/8 20 012 RMSA
<b>VFR+L Skillair® 200</b>	
3472008	VFR+L 200 1/4 20 08 RMSA
3472011	VFR+L 200 1/4 20 012 RMSA
3572008	VFR+L 200 3/8 20 08 RMSA
3572011	VFR+L 200 3/8 20 012 RMSA
3672008	VFR+L 200 1/2 20 08 RMSA
3672011	VFR+L 200 1/2 20 012 RMSA

Code	Description
<b>VFR+L Skillair® 300</b>	
4472005	VFR+L 300 1/2 20 08 RMSA
4472008	VFR+L 300 1/2 20 012 RMSA
4572005	VFR+L 300 3/4 20 08 RMSA
4572008	VFR+L 300 3/4 20 012 RMSA
4672005	VFR+L 300 1 20 08 RMSA
4672008	VFR+L 300 1 20 012 RMSA

The following versions are available on request:  
 - with 5 µm or 50 µm degree of filtration  
 - with SAC or RA condensate discharge

## ACCESSORIES

### MOUNTING BRACKET FOR REG.



Code	Description
9200701	Acc. SF100- BIT-ND1/4
9400701	Acc. SF200-ND-3/8 1/2
9400702	Acc. SF300

### PRESSURE GAUGES



Code	Description
9700101	Acc. M 40 1/8 012
9700102	Acc. M 40 1/8 04
9700109	Acc. M 40x40 1/8 04
9700110	Acc. M 40x40 1/8 012
9800101	Acc. M 50 1/8 012
9800102	Acc. M 50 1/8 04
9900101	Acc. M 63 1/4 012

### PRESSURE SECURITY KNOB



Code	Description
9200703	Acc. security knob

### INPUT/OUTPUT END PLATE KIT

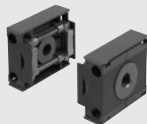

Indeks	Opis
9230401	IN/OUT end plate kit 100 1/4
9330501	IN/OUT end plate kit 100 3/8
9330601	IN/OUT end plate kit 200 1/4
9330701	IN/OUT end plate kit 200 3/8
9330801	IN/OUT end plate kit 200 1/2
9430701	IN/OUT end plate kit 300 1/2
9530901	IN/OUT end plate kit 300 3/4
9531001	IN/OUT end plate kit 300 1
9631001	IN/OUT end plate kit 400 1
9631101	IN/OUT end plate kit 400 1 1/4
9631201	IN/OUT end plate kit 400 1 1/2
9631301	IN/OUT end plate kit 400 2

### CONNECTOR KIT FOR SKILLAIR CODE A



Code	Description
9230301	Acc. connector kit 100
9330301	Acc. connector kit 200
9430301	Acc. connector kit 300
9630301	Acc. connector kit 400

### COIL SIDE 22



Code	Description
W0215000151	Acc. coil 22 Ø 8 BA 2W-12VDC
W0215000101	Acc. coil 22 Ø 8 BA 2W-24VDC
W0215000111	Acc. coil 22 Ø 8 BA 3.5VA-24VAC
W0215000121	Acc. coil 22 Ø 8 BA 3.5VA-110VAC
W0215000131	Acc. coil 22 Ø 8 BA 3VA-220VAC 50/60 HZ

### "UL" AND "CSA" COIL 22 mm

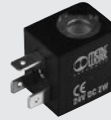

Code	Description
W0215000251	Acc. coil 22 Ø 8 BA 2W-12VDC UR
W0215000201	Acc. coil 22 Ø 8 BA 2W-24VDC UR
W0215000211	Acc. coil 22 Ø 8 BA 3.5VA-24VAC UR
W0215000221	Acc. coil 22 Ø 8 BA 3.5VA-110 VAC UR
W0215000231	Acc. coil 22 Ø 8 BA 3.5VA-220VAC UR

### KIT COIL SIDE 22 IP65 (FOR V3V-APR-LUB)



Code	Description
0222100100	Kit for coils 22 - IP65

Improved IP65 protection, even after prolonged exposure to atmospheric agents.  
Applicable to valves with a technopolimer control.

### KIT FOR COIL EEXM (FOR V3V-APR-LUB)



Code	Description
0227606913	Kit for coil 30 24 VDC EEXMT5 cable 3 m
0227606915	Kit for coil 30 24 VDC EEXMT5 cable 5 m
0227608013	Kit for coil 30 24 VAC EEXMT5 cable 3 m
0227608015	Kit for coil 30 24 VAC EEXMT5 cable 5 m
0227608023	Kit for coil 30 110 VAC EEXMT5 cable 3 m
0227608025	Kit for coil 30 110 VAC EEXMT5 cable 5 m
0227608033	Kit for coil 30 230 VAC EEXMT5 cable 3 m
0227608035	Kit for coil 30 230 VAC EEXMT5 cable 5 m

According to ATEX 94/9 CE rule  
 ⓧ II 2G Ex mb IIC T4/T5 Gb  
 ⓧ II 2D Ex tb IIIC T130/T95 °C IP66 Db

### COIL FOR CDV CDML LUBRICATOR

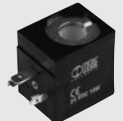

Code	Description
W0216001001	Acc. coil 24 V CC
W0216001011	Acc. coil 24V 50/60HZ
W0216001021	Acc. coil 110V 50/60HZ
W0216001031	Acc. coil 220V 50/60HZ

### COIL SIDE 30



Code	Description
W0210010100	Acc. coil 30 Ø 8 2W-24VDC
W0210011100	Acc. coil 30 Ø 8 3.5VA-24VAC 50/60 HZ
W0210012100	Acc. coil 30 Ø 8 3.5VA-110VAC 50/60 HZ
W0210013100	Acc. coil 30 Ø 8 3.5VA-220VAC 50/60 HZ

### ELECTRIC CONNECTOR SIDE 22



Code	Description
W0970510011	Acc. connector 22 standard
W0970510012	Acc. connector 22 LED 24V
W0970510013	Acc. connector 22 LED 110V
W0970510014	Acc. connector 22 LED 220V
W0970510015	Acc. connector 22 LED VDR 24V
W0970510016	Acc. connector 22 LED VDR 110V
W0970510017	Acc. connector 22 LED VDR 220V
W0970510070	Acc. connector 22 ATEX II 2 GD

### ELECTRIC CONNECTOR SIDE 30



Code	Description
W0970520033	Acc. connector 30 STD
W0970520034	Acc. connector 30 LED 24V
W0970520035	Acc. connector 30 LED 110V
W0970520036	Acc. connector 30 LED 220V
W0970520037	Acc. connector 30 LED VDR 24V
W0970520038	Acc. connector 30 LED VDR 110V
W0970520039	Acc. connector 30 LED VDR 220V

### M8 STRAIGHT CONNECTOR WITH CABLE FOR PRESSURE SWITCHES



Code	Description
02400A0100	M8 female 3 PIN HIGH FLEX CL6 connector with cable L = 1 m
02400A0250	M8 female 3 PIN HIGH FLEX CL6 connector with cable L = 2.5 m
02400A0500	M8 female 3 PIN HIGH FLEX CL6 connector with cable L = 5 m
02400A1000	M8 female 3 PIN HIGH FLEX CL6 connector with cable L = 10 m

Mobile laying cable, class 6 according to IEC 60228

## SPARE PARTS

### FILTER BOWL



Code	Description
9253301	Spare TF 100 RMSA
9255301	Spare TF 100 SAC
9353301	Spare TF 200 RMSA
9355301	Spare TF 200 SAC
9453301	Spare TF 300 RA
9453401	Spare TF 300 RMSA
9653301	Spare TF 400 RA
9653401	Spare TF 400 RMSA

### LUBRICATOR BOWL



Code	Description
9253501	Spare TL 100
9202503	Spare TL 100 CA
9202502	Spare TL 100 CD
9202501	Spare TL 100 ML
9353501	Spare TL 200
9302501	Spare TL 200 CA
9302503	Spare TL 200 CD
9302502	Spare TL 200 ML
9453501	Spare TL 300
9202401	Spare TL 300 CA
9202403	Spare TL 300 CD
9202402	Spare TL 300 ML
9653501	Spare TL 400
9653502	Spare TL 400 CA
9653503	Spare TL 400 CD
9653504	Spare TL 400 ML

### FILTERING ELEMENTS



Code	Description
9251705	Spare FP 100 5
9251706	Spare FP 100 20
9251707	Spare FP 100 50
9351705	Spare FP 200 5
9351706	Spare FP 200 20
9351707	Spare FP 200 50
9451705	Spare FP 300 5
9451706	Spare FP 300 20
9451707	Spare FP 300 50
9651705	Spare FP 400 5
9651706	Spare FP 400 20
9651707	Spare FP 400 50

### FILTERING/PURIFICATION ELEMENTS



Code	Description
9251711	Spare FP DEP. 100
9351711	Spare FP DEP. 200
9451711	Spare FP DEP. 300
9651711	Spare FP DEP. 400

### CARTRIDGE AC



Code	Description
9251713	Spare cartridge 100 AC
9351713	Spare cartridge 200 AC
9451713	Spare cartridge 300 AC
9651712	Spare cartridge 400 AC

### VENTURI LUBRICATOR DIAPHRAGM



Code	Description
9252001	Spare MB 100 ND 1/4
9352001	Spare MB 200 ND 3/8-1/2
9452001	Spare MB 300
9652601	Spare MB 400

### UPPER COVER FOR REGULATOR AND FILTER REGULATOR



Code	Description
9250800	Spare CS 100 02
9250810	Spare CS 100 04
9250811	Spare CS 100 08
9250812	Spare CS 100 012
9350800	Spare CS 200 02
9350810	Spare CS 200 04
9350811	Spare CS 200 08
9350812	Spare CS 200 012
9450805	Spare CS 300 04
9450806	Spare CS 300 08
9450807	Spare CS 300 012
9450808	Spare CS 300 02

### COMPLETE POPPET FOR REGULATORS



Code	Description
9250704	Spare OTR 100
9350704	Spare OTR 200
9450704	Spare OTR 300
9650704	Spare OTR 400

### COMPLETE POPPET FOR FR



Code	Description
9250902	Spare OTFR 100 5
9250903	Spare OTFR 100 20
9250904	Spare OTFR 100 50
9350902	Spare OTFR 200 5
9350903	Spare OTFR 200 20
9350904	Spare OTFR 200 50
9450902	Spare OTFR 300 5
9450903	Spare OTFR 300 20
9450904	Spare OTFR 300 50

### UPPER COVER DISASSEMBLY SPANNER



Code	Description
9220701	Spare cover spanner

### REG AND FR VISUAL DOME DISASSEMBLY SPANNER



Code	Description
9220401	Spare dome dis. spanner 100
9323401	Spare dome dis. spanner 200
9420401	Spare dome dis. spanner 300

### POPET DISASSEMBLY SPANNER (FOR REG.)



Code	Description
9220501	Spare R cap disass. WR. 100
9323501	Spare R cap disass. WR. 200
9420501	Spare R cap disass. WR. 300

### CAP DISASSEMBLY SPANNER



Code	Description
9220601	Spare cap disass. 100
9323601	Spare cap disass. 200
9420601	Spare cap disass. 300

### POPET DISASSEMBLY SPANNER (FOR FR)



Code	Description
9220801	Spare FR cap disass. WR. 100
9320801	Spare FR cap disass. WR. 200
9420801	Spare FR cap disass. WR. 300

### PROVISION FOR MICRO SOLENOID CONTROL FOR APR-300



Code	Description
9453601	Spare PCE micro

### PROVISION FOR SOLENOID CONTROL TO CNOMO FOR APR-300



Code	Description
9454001	Spare PCE to Cnomo

### PROVISION FOR PNEUMATIC CONTROL FOR APR-300



Code	Description
9453701	Spare PCP pneumatic

### CNOMO SOLENOID CONTROL FOR APR and V3V 300 - 400 (COIL SIDE)



Code	Description
9453901	Spare CEC Cnomo 24CC
9453902	Spare CEC Cnomo 24V
9453903	Spare CEC Cnomo 110V
9453904	Spare CEC Cnomo 220V

### MICRO SOLENOID CONTROL FOR APR and V3V 300-400 (no more in the catalogue)



Code	Description
9453801	Spare CEM micro 24CC
9453802	Spare CEM micro 24V
9453803	Spare CEM micro 110V
9453804	Spare CEM micro 220V

### KEY-OPERATED V3V 400



Code	Description
9455401	Spare kit C.C. 400
9455601	Spare kit lockable 400

### INPUT/OUTPUT COVER PLATE



Code	Description
9152103	Spare OUTPUT cover plate 100
9152105	Spare INPUT cover plate 100
9152115	Spare OUTPUT cover plate 200
9152116	Spare INPUT cover plate 200
9152104	Spare OUTPUT cover plate 300
9152106	Spare INPUT cover plate 300
9152118	Spare OUTPUT cover plate 400
9152119	Spare INPUT cover plate 400

### INTERMEDIATE COVER PLATE



Code	Description
9152107	Spare intermediate cover plate 100
9152114	Spare intermediate cover plate 200
9152108	Spare intermediate cover plate 300
9152117	Spare intermediate cover plate 400

### TRANSPARENT LUBRICATOR COVER



Code	Description
9251302	Spare CVL 100-200-300-400 BIT

### AUTOMATIC DRAIN (RA)



Code	Description
9000802	Spare RA automatic drain

### AUTOMATIC DRAIN (SAC)



Code	Description
9000803	Spare SAC automatic drain

### SPRINGS FOR REGULATOR AND FILTER REGULATOR



Code	Description
9250605	Spare MO 100 02
9250606	Spare MO 100 04
9250607	Spare MO 100 08
9250608	Spare MO 100 012
9350605	Spare MO 200 02
9350606	Spare MO 200 04
9350607	Spare MO 200 08
9350608	Spare MO 200 012
9450605	Spare MO 300 04
9450606	Spare MO 300 08
9450607	Spare MO 300 012
9450608	Spare MO 300 02





GENERAL TECHNICAL DATA		ND 1/4"	ND 3/8"	ND 1/2"	ND 3/4"	ND 1"
Threaded port		1/4"	3/8"	1/2"	3/4"	1"
Degree of filtration	µm	4 - 20 - 50				
Degree of purification	µm	99.97% at 0.01				
Setting range	bar	0 to 2 - 0 to 4 - 0 to 8 - 0 to 12				
Max. input pressure	MPa	1.8				
	bar	18				
	psi	261				
Flow rate at 6.3 bar (0.63 MPa to 91 psi) ΔP 0.5 bar (0.05 MPa to 7 psi)	Nl/min	from 200 at 12000				
Fluid		Lubricated or unlubricated compressed air				
Temperature range at 1 MPa; 10 bar; 145 psi	°C	-10 to +50				
	°F	14 to 122				
Elements comprising the range		Filter, Depurator, Regulator, Pilot operated Regulator, In-series Regulator, Filter-regulator, Lubricator, Circuit Shut-off Valve				

## FILTER



TECHNICAL DATA		FIL ND 1/4"	FIL ND 3/8"	FIL ND 1/2"	FIL ND 3/4"	FIL ND 1"
Threaded port		1/4"	3/8"	1/2"	3/4"	1"
Degree of filtration	µm	4 - 20 - 50		4 - 20 - 50		4 - 20 - 50
Max. inlet pressure	MPa	1.8		1.8		1.8
	bar	18		18		18
	psi	261		261		261
Flow rate at 6.3 bar (0.63 MPa to 91 psi) ΔP 0.5 bar (0.05 MPa to 7 psi)	Nl/min	1300	3100		9100	
	scfm	46	110		324	
Flow rate at 6.3 bar (0.63 MPa to 91 psi) ΔP 1 bar (0.1 MPa to 14 psi)	Nl/min	1720	4100		11000	
	scfm	61	146		391	
Max temperature at 1 MPa; 10 bar; 145 psi	°C	50°		50°		50°
	°F	122°		122°		122°
Weight	kg	0.4	0.9		1.2	
Wall fixing screws		M4 x 40	M4 x 55		M6 x 75	
Bowl capacity	cm <sup>3</sup>	10	45		170	
Mounting position		Vertical	Vertical		Vertical	
Drain		RMSA - SAC	RMSA - SAC - RA		RMSA - RA	
		RMSA: drain with manual condensate discharge and automatic discharge at zero pressure. RA: automatic drain with condensate discharge, independent of pressure and flow rate. Version conveys the draining by inserting the pipe having internal diameter 6 mm in the lower port. SAC: automatic drain with condensate discharge. <b>Operates by depression - requires variable air take-offs.</b> Compressed air <b>The maximum inlet pressure for the version with RA automatic condensate drainage must not exceed 10 bar.</b>				

Code	Description	Code	Description	Code	Description	Code	Description	Code	Description
<b>NEW DEAL FILTER 1/4"</b>		<b>NEW DEAL FILTER 3/8"</b>		<b>NEW DEAL FILTER 1/2"</b>		<b>NEW DEAL FILTER 3/4"</b>		<b>NEW DEAL FILTER 1"</b>	
1221005	FIL 1/4 4 RMSA	1321005	FIL 3/8 4 RMSA	1421005	FIL 1/2 4 RMSA	1521005	FIL 3/4 4 RMSA	1621005	FIL 1 4 RMSA
1221013	FIL 1/4 4 SAC	1321009	FIL 3/8 4 RA	1421009	FIL 1/2 4 RA	1521009	FIL 3/4 4 RA	1621009	FIL 1 4 RA
1221006	FIL 1/4 20 RMSA	1321013	FIL 3/8 4 SAC	1421013	FIL 1/2 4 SAC	1521006	FIL 3/4 20 RMSA	1621006	FIL 1 20 RMSA
1221014	FIL 1/4 20 SAC	1321006	FIL 3/8 20 RMSA	1421006	FIL 1/2 20 RMSA	1521010	FIL 3/4 20 RA	1621010	FIL 1 20 RA
1221008	FIL 1/4 50 RMSA	1321010	FIL 3/8 20 RA	1421010	FIL 1/2 20 RA	1521008	FIL 3/4 50 RMSA	1621008	FIL 1 50 RMSA
1221016	FIL 1/4 50 SAC	1321014	FIL 3/8 20 SAC	1421014	FIL 1/2 20 SAC	1521012	FIL 3/4 50 RA	1621012	FIL 1 50 RA
		1321008	FIL 3/8 50 RMSA	1421008	FIL 1/2 50 RMSA				
		1321012	FIL 3/8 50 RA	1421012	FIL 1/2 50 RA				
		1321016	FIL 3/8 50 SAC	1421016	FIL 1/2 50 SAC				



## DEPURATOR



TECHNICAL DATA	DEP ND 3/8"	DEP ND 1/2"
Threaded port	3/8"	1/2"
Degree of depuration	99.97% α 0.01	
Max. inlet pressure	1.8 MPa 18 bar 261 psi	
Suggested flow rate at 6 bar	230 Nl/min 8 scfm	
Fluid	Filtered air 4 μm	
Max temperature at 1 MPa; 10 bar; 145 psi	50 °C 122 °F	
Weight	0.9 kg	
Wall fixing screws	M4 x 55	
Bowl capacity	45 cm <sup>3</sup>	
Mounting position	Vertical	
Drain	RMSA - SAC - RA	
	RMSA: drain with manual condensate discharge and automatic discharge at zero pressure. RA: automatic drain with condensate discharge, independent of pressure and flow rate. Version conveys the draining by inserting the pipe having internal diameter 6 mm in the lower port. SAC: automatic drain with condensate discharge.	
	<b>Operates by depression – requires variable air take-offs.</b> It is advisable to mount a 4 μm filter upstream the depurator acting as a rough filter. <b>The maximum inlet pressure for the version with RA automatic condensate drainage must not exceed 10 bar.</b>	
Note on use		

Code	Description	Code	Description
DEPURATOR NEW DEAL 3/8"		DEPURATOR NEW DEAL 1/2"	
1322002	DEP 3/8 RMSA	1422002	DEP 1/2 RMSA
1322003	DEP 3/8 RA	1422003	DEP 1/2 RA
1322004	DEP 3/8 SAC	1422004	DEP 1/2 SAC

## REGULATOR



TECHNICAL DATA	REG ND 1/4"	REG ND 3/8"	REG ND 1/2"	REG ND 3/4"	REG ND 1"
Threaded port	1/4"	3/8"	1/2"	3/4"	1"
Setting range	0 to 4 - 0 to 8 - 0 to 12 bar				
Max. inlet pressure	1.8 MPa 18 bar 261 psi				
Flow rate at 6.3 bar (0.63 MPa to 91 psi) ΔP 0.5 bar (0.05 MPa to 7 psi)	200 Nl/min 7 scfm	1100 Nl/min 39 scfm	2500 Nl/min 89 scfm		
Flow rate at 6.3 bar (0.63 MPa to 91 psi) ΔP 1 bar (0.1 MPa to 14 psi)	650 Nl/min 23 scfm	2500 Nl/min 89 scfm	4500 Nl/min 160 scfm		
Max temperature at 1 MPa; 10 bar; 145 psi	50 °C 122 °F				
Weight	0.3 kg	0.8 kg	1.5 kg		
Wall fixing screws	M4 x 40	M4 x 55	M6 x 75		
Gauge port	1/8"	1/8"	1/4"		
Mounting position	In any position				
Fluid	Filtered, lubricated or unlubricated compressed air. Lubrication, if used, must be continuous.				
Note on use	The regulator pressure must always be set upwards. For increased sensitivity, use a pressure regulator with a rated pressure as close as possible to the required value. <b>Do not take off air from gauge ports.</b>				

Code	Description	Code	Description	Code	Description
NEW DEAL REGULATOR 1/4"		NEW DEAL REGULATOR 3/8"		NEW DEAL REGULATOR 3/4"	
1202001	REG 1/4 04	1302001	REG 3/8 04	1502001	REG 3/4 04
1202002	REG 1/4 08	1302002	REG 3/8 08	1502002	REG 3/4 08
1202003	REG 1/4 012	1302003	REG 3/8 012	1502003	REG 3/4 012
1202004	REG 1/4 02	NEW DEAL REGULATOR 1/2"		NEW DEAL REGULATOR 1"	
		1402001	REG 1/2 04	1602001	REG 1 04
		1402002	REG 1/2 08	1602002	REG 1 08
		1402003	REG 1/2 012	1602003	REG 1 012

## OPERATED REGULATOR



TECHNICAL DATA	REG PIL 3/8"		REG PIL 1/2"	
	3/8"		1/2"	
Threaded port	Depending on pilot			
Setting range	bar			
Max. inlet pressure	MPa			
	bar			
	psi			
Flow rate at 6.3 bar (0.63 MPa to 91 psi) ΔP 0.5 bar (0.05 MPa to 7 psi)	Nl/min	3500		
	scfm	124		
Flow rate at 6.3 bar (0.63 MPa to 91 psi) ΔP 1 bar (0.1 MPa to 14 psi)	Nl/min	4500		
	scfm	160		
Max temperature at 1 MPa; 10 bar; 145 psi	°C	50		
	°F	122		
Weight	kg	0.8		
Wall fixing screws	M4 x 55			
Gauge port	1/8"			
Mounting position	In any position			
Fluid	Filtered, lubricated or unlubricated compressed air. Lubrication, if used, must be continuous.			
Note on use	The regulator pressure must always be set upwards. Overpressure relieving from the pilot. <b>Do not take air from pressure gauge ports.</b>			

Code	Description
1302004	RP 3/8 pilot operated regulator
1402004	RP 1/2 pilot operated regulator

## REGULATOR-REGULATOR WITH V3V 3/4"-1"



TECHNICAL DATA	3/4"		1"	
	Threaded port	0 to 2 - 0 to 4 - 0 to 8 - 0 to 12		
Setting range	bar			
*Max. inlet pressure	MPa			
	bar			
	psi			
Flow rate at 6.3 bar (0.63 MPa to 91 psi) ΔP 0.5 bar (0.05 MPa to 7 psi)	Nl/min	12000		
	scfm	423		
Flow rate at 6.3 bar (0.63 MPa to 91 psi) ΔP 1 bar (0.1 MPa to 14 psi)	Nl/min	13000		
	scfm	460		
Fluid	Lubricated or unlubricated filtered air. If lubrication is used, it must be continuous.			
Drain flow rate at 6 bar (0.6 MPa to 87 psi)	Nl/min	1800		
	scfm	64		
Max temperature at 10 bar (1 MPa to 145 psi)	°C	50		
	°F	122		
Weight	kg	1.7		
Wall fixing screws	M6 x 75			
Mounting position	In any position			
Note on use	<b>Do not take air from pressure gauge ports.</b>			

\* Version Reg + V3V Cnomo (1 Mpa - 10 bar -145 psi)

Code	Description	Code	Description	Code	Description	Code	Description
<b>PILOTTED REGULATOR NEW DEAL P 3/4"</b>		<b>REGULATOR WITH BUILT-IN SHUT-OFF VALVE NEW DEAL 3/4"</b>		<b>PILOTTED REGULATOR NEW DEAL 1"</b>		<b>REGULATOR WITH BUILT-IN SHUT-OFF VALVE NEW DEAL 1"</b>	
1519001	REGP 3/4 00	1517001	RV3V 3/4 02 ELPN	1619001	REGP 1 00	1617001	RV3V 1 02 ELPN
1518001	REGP 3/4 02	1517002	RV3V 3/4 04 ELPN	1618001	REGP 1 02	1617002	RV3V 1 04 ELPN
1518002	REGP 3/4 04	1517003	RV3V 3/4 08 ELPN	1618002	REGP 1 04	1617003	RV3V 1 08 ELPN
1518003	REGP 3/4 08	1516101	RV3V 3/4 02 key	1618003	REGP 1 08	1616101	RV3V 1 02 key
1518004	REGP 3/4 012	1516102	RV3V 3/4 04 key	1618004	REGP 1 012	1616102	RV3V 1 04 key
		1516103	RV3V 3/4 08 key			1616103	RV3V 1 08 key
		1516104	RV3V 3/4 012 key			1616104	RV3V 1 012 key
		1516001	RV3V 3/4 02 manual			1616001	RV3V 1 02 manual
		1516002	RV3V 3/4 04 manual			1616002	RV3V 1 04 manual
		1516003	RV3V 3/4 08 manual			1616003	RV3V 1 08 manual
		1516004	RV3V 3/4 012 manual			1616004	RV3V 1 012 manual

## PADLOCKABLE REGULATOR



Look at regulator for technical data

Code	Description	Code	Description	Code	Description
<b>NEW DEAL PADLOCKABLE REGULATOR 1/4"</b>		<b>NEW DEAL PADLOCKABLE REGULATOR 3/8"</b>		<b>NEW DEAL PADLOCKABLE REGULATOR 1/2"</b>	
1210011	REG KEY 1/4 02	1310012	REG KEY 3/8 04	1410012	REG KEY 1/2 04
1210012	REG KEY 1/4 04	1310013	REG KEY 3/8 08	1410013	REG KEY 1/2 08
1210013	REG KEY 1/4 08	1310014	REG KEY 3/8 012	1410014	REG KEY 1/2 012
1210014	REG KEY 1/4 012				

## FILTER REGULATOR



TECHNICAL DATA		FR ND 1/4"	FR ND 3/8"	FR ND 1/2"
Threaded port		1/4"	3/8"	1/2"
Setting range	bar	0 to 8 - 0 to 12		0 to 8 - 0 to 12
Degree of filtration	µm	4 - 20 - 50		4 - 20 - 50
Max. inlet pressure	MPa	1.8		1.8
	bar	18		18
	psi	261		261
Flow rate at 6.3 bar (0.63 MPa to 91 psi) ΔP 0.5 bar (0.05 MPa to 7 psi)	Nl/min	260		1000
	scfm	9.2		35.5
Flow rate at 6.3 bar (0.63 MPa to 91 psi) ΔP 1 bar (0.1 MPa to 14 psi)	Nl/min	700		2500
	scfm	25		88.5
Max temperature at 1 MPa; 10 bar; 145 psi	°C	50		50
	°F	122		122
Weight	kg	0.5		1
Wall fixing screws		M4 x 40		M4 x 55
Gauge port		1/8"		1/8"
Bowl capacity	cm <sup>3</sup>	10		45
Mounting position		Vertical		Vertical
Drain		RMSA - SAC		RMSA - SAC - RA
		RMSA: drain with manual condensate discharge and automatic discharge at zero pressure		
		RA: automatic drain with condensate discharge, independent of pressure and flow rate		
		Version conveys the draining by inserting the pipe having internal diameter 6 mm in the lower port.		
		SAC: automatic drain with condensate discharge.		
		<b>Operates by depression – requires variable air take-offs.</b>		
		Compressed air		
Fluid		The regulator pressure must always be set upwards. <b>The maximum inlet pressure for the version with RA automatic condensate drainage must not exceed 10 bar. Do not take air from pressure gauge ports.</b>		
Note on use				

Code	Description	Code	Description	Code	Description
<b>NEW DEAL FILTER REGULATOR 1/4"</b>		<b>NEW DEAL FILTER REGULATOR 3/8"</b>		<b>NEW DEAL FILTER REGULATOR 1/2"</b>	
1225029	FR 1/4 4 08 RMSA	1325029	FR 3/8 4 08 RMSA	1425029	FR 1/2 4 08 RMSA
1225053	FR 1/4 4 012 RMSA	1325509	FR 3/8 4 08 SAC	1425509	FR 1/2 4 08 SAC
1225509	FR 1/4 4 08 SAC	1325053	FR 3/8 4 012 RMSA	1425053	FR 1/2 4 012 RMSA
1225513	FR 1/4 4 012 SAC	1325513	FR 3/8 4 012 SAC	1425513	FR 1/2 4 012 SAC
1225030	FR 1/4 20 08 RMSA	1325030	FR 3/8 20 08 RMSA	1425030	FR 1/2 20 08 RMSA
1225510	FR 1/4 20 08 SAC	1325510	FR 3/8 20 08 SAC	1425510	FR 1/2 20 08 SAC
1225054	FR 1/4 20 012 RMSA	1325054	FR 3/8 20 012 RMSA	1425054	FR 1/2 20 012 RMSA
1225514	FR 1/4 20 012 SAC	1325514	FR 3/8 20 012 SAC	1425514	FR 1/2 20 012 SAC
1225032	FR 1/4 50 08 RMSA	1325032	FR 3/8 50 08 RMSA	1425032	FR 1/2 50 08 RMSA
1225511	FR 1/4 50 08 SAC	1325512	FR 3/8 50 08 SAC	1425512	FR 1/2 50 08 SAC
1225056	FR 1/4 50 012 RMSA	1325056	FR 3/8 50 012 RMSA	1425056	FR 1/2 50 012 RMSA
1225516	FR 1/4 50 012 SAC	1325516	FR 3/8 50 012 SAC	1425516	FR 1/2 50 012 SAC

For ND 3/8 and 1/2 with RA, please contact our sales assistance department

## SUB-BASE

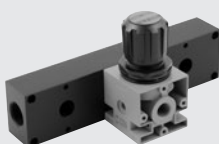

Code	Description	Code	Description
9200201	SB 1/4 sub-base 2 pos.	9200301	SB 1/4 sub-base 3 pos.
9400201	SB 1/2 sub-base 2 pos.	9400301	SB 1/2 sub-base 3 pos.
9600201	SB 3/4 sub-base 2 pos.	9600301	SB 3/4 sub-base 3 pos.

## LUBRICATOR



TECHNICAL DATA		LUB ND 1/4"	LUB ND 3/8"	LUB ND 1/2"	LUB ND 3/4"	LUB ND 1"
Threaded port		1/4"	3/8"	1/2"	3/4"	1"
Type of lubrication		Mist		Mist		Mist
Bowl capacity	cm <sup>3</sup>	50		150		380
Max. inlet pressure	MPa	1.8		1.8		1.8
	bar	18		18		18
	psi	261		261		261
Flow rate at 6 bar (0.6 MPa to 87 psi) ΔP 0.5 bar (0.05 MPa to 7 psi)	Nl/min	700		3000		12800
	scfm	25		107		452
Flow rate at 6 bar (0.6 MPa to 87 psi) ΔP 1 bar (0.1 MPa to 14 psi)	Nl/min	1100		4300		16000
	scfm	39		153		565
Max temperature at 1 MPa; 10 bar; 145 psi	°C	50		50		50
	°F	122		122		122
Weight	kg	0.4		0.9		1.3
Wall fixing screws		M4 x 40		M4 x 55		M6 x 75
Mounting position		Vertical				
Fluid		Filtered compressed air				
Note on use:		<ul style="list-style-type: none"> <li>• Use the screw provided to set the drip rate to drop every 300-600 Nl.</li> <li>• Fit the lubricator as close as possible to the point of use</li> <li>• Fill the bowl with oil before pressurizing the system</li> <li>• Do not use cleaning oil, brake fluid or solvents in general</li> <li>• Recommended lubricants: ISO and UNI FD22 - E.g. Energol HLP 22 (BP) - Spinesso 22 (Esso) - Mobil DTE 22 (Mobil) - Tellus Oil 22 (Shell)</li> </ul>				

Code	Description
1223001	LUB 1/4
1323001	LUB 3/8
1423001	LUB 1/2
1523001	LUB 3/4
1623001	LUB 1

## SHUT-OFF VALVE



TECHNICAL DATA		V3V ND 1/4"	V3V ND 3/8"	V3V ND 1/2"
Threaded port		1/4"	3/8"	1/2"
Max. inlet pressure	MPa	1.8		1.8
	bar	18		18
	psi	261		261
Flow rate at 6.3 bar (0.63 MPa to 91 psi) ΔP 0.5 bar (0.05 MPa to 7 psi)	Nl/min	1100		2200
	scfm	38.8		78
Flow rate at 6.3 bar (0.63 MPa to 91 psi) ΔP 1 bar (0.1 MPa to 14 psi)	Nl/min	1500		2900
	scfm	53		103
Flow rate on relieving at 6 bar (0.6 MPa to 87 psi) with direct relieving into the atmosphere	Nl/min	1600		2900
	scfm	56.5		103
Max temperature at 1 MPa; 10 bar; 145 psi	°C	50		50
	°F	122		122
Weight	kg	0.35		0.8
Wall fixing screws		M4 x 40		M4 x 55
Mounting position		In any position		
Fluid		Filtered, lubricated or unlubricated compressed air. Lubrication, if used, must be continuous.		
Type of control		Manual		

Code	Description
1270001	V3V ND 1/4
1370001	V3V ND 3/8
1470001	V3V ND 1/2

## 3/4" AND 1" SHUT-OFF VALVE



TECHNICAL DATA		V3V ND 3/4"	V3V ND 1"
Threaded port		3/4"	1"
Max. inlet pressure*	MPa		1.3
	bar		13
	psi		188
Flow rate at 6.3 bar (0.63 MPa to 91 psi) ΔP 0.5 bar (0.05 MPa to 7 psi)	NI/min		7600
	scfm		268
Flow rate at 6.3 bar (0.63 MPa to 91 psi) ΔP 1 bar (0.1 MPa to 14 psi)	NI/min		10200
	scfm		360
Flow rate on relief at 6 bar (0.6 MPa; 87 psi)	NI/min		1800
	scfm		64
Weight	kg		2.2
Wall fixing screws			M6 x 75
Mounting position			In any position
Fluid			Filtered, lubricated or unlubricated compressed air. Lubrication, if used, must be continuous.
*V3V CNOMO -10 bar - 1 MPa - 145 psi			

Code	Description
	<b>SHUT-OFF VALVE NEW DEAL 3/4"</b>
1575001	V3V 3/4 ELPN Cnomo
1574101	V3V 3/4 key
1574001	V3V 3/4 manual
1576001	V3V 3/4 pneumatic

Code	Description
	<b>SHUT-OFF VALVE NEW DEAL 1"</b>
1675001	V3V 1 ELPN Cnomo
1674101	V3V 1 key
1674001	V3V 1 manual
1676001	V3V 1 pneumatic

## AIR TAKE-OFF



TECHNICAL DATA		PA ND 1/4"	PA ND 3/8"	PA ND 1/2"	PA ND 3/4"	PA ND 1"
Threaded port		1/8"		1/4"		1/2"
Maximum working temperature at: 1 MPa; 10 bar; 145 psi	°C	50		50		50
	°F	122		122		122
Maximum admissible pressure	MPa	1.8		1.8		1.8
	bar	18		18		18
	psi	261		261		261
Weight	kg	0.06		0.18		0.41

Code	Description
9200401	PA 1/4 take-off
9400401	PA 1/2 take-off
9600401	PA 3/4 take-off

Comes with 2 screws for F/L and R/FR fixing

## AUTOMATIC CONDENSATE DRAIN



TECHNICAL DATA		SCAL ND 1/2"
Threaded port		1/2"
Maximum working temperature at: 1 MPa; 10 bar; 145 psi	°C	50
	°F	122
Maximum admissible pressure	MPa	1
	bar	10
	psi	188
Weight	kg	1.45

Code	Description
4589003	Autom. cond. drain 1/2 in line

## FIL+REG+LUB



Code	Description
<b>FRL 1/4"</b>	
1224029	FRL 1/4 4 08 RMSA
1224409	FRL 1/4 4 08 SAC
1224030	FRL 1/4 20 08 RMSA
1224410	FRL 1/4 20 08 SAC
1224032	FRL 1/4 50 08 RMSA
1224412	FRL 1/4 50 08 SAC
1224053	FRL 1/4 4 012 RMSA
1224413	FRL 1/4 4 012 SAC
1224054	FRL 1/4 20 012 RMSA
1224414	FRL 1/4 20 012 SAC
1224056	FRL 1/4 50 012 RMSA
1224416	FRL 1/4 50 012 SAC
<b>FRL 3/8"</b>	
1324029	FRL 3/8 4 08 RMSA
1324033	FRL 3/8 4 08 RA
1324409	FRL 3/8 4 08 SAC
1324030	FRL 3/8 20 08 RMSA
1324034	FRL 3/8 20 08 RA
1324410	FRL 3/8 20 08 SAC
1324032	FRL 3/8 50 08 RMSA
1324036	FRL 3/8 50 08 RA
1324412	FRL 3/8 50 08 SAC
1324053	FRL 3/8 4 012 RMSA
1324057	FRL 3/8 4 012 RA
1324413	FRL 3/8 4 012 SAC
1324054	FRL 3/8 20 012 RMSA
1324058	FRL 3/8 20 012 RA
1324414	FRL 3/8 20 012 SAC
1324056	FRL 3/8 50 012 RMSA
1324060	FRL 3/8 50 012 RA
1324416	FRL 3/8 50 012 SAC
<b>FRL 3/4"</b>	
1524017	FRL 3/4 4 08 RMSA
1524021	FRL 3/4 4 08 RA
1524018	FRL 3/4 20 08 RMSA
1524022	FRL 3/4 20 08 RA
1524020	FRL 3/4 50 08 RMSA
1524024	FRL 3/4 50 08 RA
1524029	FRL 3/4 4 012 RMSA
1524033	FRL 3/4 4 012 RA
1524030	FRL 3/4 20 012 RMSA
1524034	FRL 3/4 20 012 RA
1524032	FRL 3/4 50 012 RMSA
1524036	FRL 3/4 50 012 RA
<b>FRL 1"</b>	
1624017	FRL 1 4 08 RMSA
1624021	FRL 1 4 08 RA
1624018	FRL 1 20 08 RMSA
1624022	FRL 1 20 08 RA
1624020	FRL 1 50 08 RMSA
1624024	FRL 1 50 08 RA
1624029	FRL 1 4 012 RMSA
1624033	FRL 1 4 012 RA
1624030	FRL 1 20 012 RMSA
1624034	FRL 1 20 012 RA
1624032	FRL 1 50 012 RMSA
1624036	FRL 1 50 012 RA

## FRPL 3/4"-1"



Code	Description
<b>FRPL 3/4"</b>	
1528007	FRPL 3/4 4 08 RMSA
1528019	FRPL 3/4 4 08 RA
1528010	FRPL 3/4 4 012 RMSA
1528022	FRPL 3/4 4 012 RA
1528008	FRPL 3/4 20 08 RMSA
1528020	FRPL 3/4 20 08 RA
1528011	FRPL 3/4 20 012 RMSA
1528023	FRPL 3/4 20 012 RA
1528009	FRPL 3/4 50 08 RMSA
1528021	FRPL 3/4 50 08 RA
1528012	FRPL 3/4 50 012 RMSA
1528024	FRPL 3/4 50 012 RA
<b>FRPL 1"</b>	
1628007	FRPL 1 4 08 RMSA
1628019	FRPL 1 4 08 RA
1628010	FRPL 1 4 012 RMSA
1628022	FRPL 1 4 012 RA
1628008	FRPL 1 20 08 RMSA
1628020	FRPL 1 20 08 RA
1628011	FRPL 1 20 012 RMSA
1628023	FRPL 1 20 012 RA
1628009	FRPL 1 50 08 RMSA
1628021	FRPL 1 50 08 RA
1628012	FRPL 1 50 012 RMSA
1628024	FRPL 1 50 012 RA

## FR+LUB



Code	Description
<b>FR+L 1/4"</b>	
1226029	FR+L 1/4 4 08 RMSA
1226409	FR+L 1/4 4 08 SAC
1226053	FR+L 1/4 4 012 RMSA
1226413	FR+L 1/4 4 012 SAC
1226030	FR+L 1/4 20 08 RMSA
1226410	FR+L 1/4 20 08 SAC
1226054	FR+L 1/4 20 012 RMSA
1226414	FR+L 1/4 20 012 SAC
1226032	FR+L 1/4 50 08 RMSA
1226412	FR+L 1/4 50 08 SAC
1226056	FR+L 1/4 50 012 RMSA
1226416	FR+L 1/4 50 012 SAC
<b>FR+L 3/8"</b>	
1326029	FR+L 3/8 4 08 RMSA
1326409	FR+L 3/8 4 08 SAC
1326053	FR+L 3/8 4 012 RMSA
1326413	FR+L 3/8 4 012 SAC
1326030	FR+L 3/8 20 08 RMSA
1326034	FR+L 3/8 20 08 RA
1326410	FR+L 3/8 20 08 SAC
1326054	FR+L 3/8 20 012 RMSA
1326058	FR+L 3/8 20 012 RA
1326414	FR+L 3/8 20 012 SAC
1326032	FR+L 3/8 50 08 RMSA
1326412	FR+L 3/8 50 08 SAC
1326056	FR+L 3/8 50 012 RMSA
1326416	FR+L 3/8 50 012 SAC
<b>FR+L 1/2"</b>	
1426029	FR+L 1/2 4 08 RMSA
1426409	FR+L 1/2 4 08 SAC
1426053	FR+L 1/2 4 012 RMSA
1426413	FR+L 1/2 4 012 SAC
1426030	FR+L 1/2 20 08 RMSA
1426034	FR+L 1/2 20 08 RA
1426410	FR+L 1/2 20 08 SAC
1426054	FR+L 1/2 20 012 RMSA
1426058	FR+L 1/2 20 012 RA
1426414	FR+L 1/2 20 012 SAC
1426032	FR+L 1/2 50 08 RMSA
1426412	FR+L 1/2 50 08 SAC
1426056	FR+L 1/2 50 012 RMSA
1426416	FR+L 1/2 50 012 SAC

For ND 3/8 and 1/2 with RA, please contact our sales assistance department.

## V3V+FR+LUB



Code	Description
1272030	VFR+L 1/4 20 RMSA 08
1272054	VFR+L 1/4 20 RMSA 012
1372030	VFR+L 3/8 20 RMSA 08
1372054	VFR+L 3/8 20 RMSA 012
1472030	VFR+L 1/2 20 RMSA 08
1472054	VFR+L 1/2 20 RMSA 012
1472032	VFR+L 1/2 50 RMSA 08
1472056	VFR+L 1/2 50 RMSA 012

The following versions are available on request:  
 - with 4 µm or 50 µm degree of filtration  
 - with SAC or RA condensate discharge

## FIL+DEP



Code	Description
1327004	F+D 3/8 4 RMSA-RMSA
1327007	F+D 3/8 4 RA-RA
1327104	F+D 3/8 4 SAC-RMSA
1427004	F+D 1/2 4 RMSA-RMSA
1427007	F+D 1/2 4 RA-RA
1427104	F+D 1/2 4 SAC-RMSA

## FIL+LUB



Code	Description
1233006	F+L 1/4 20 RMSA
1333006	F+L 3/8 20 RMSA
1433006	F+L 1/2 20 RMSA
1533006	F+L 3/4 20 RMSA
1633006	F+L 1 20 RMSA

The following versions are available on request:  
 - with 4 µm or 50 µm degree of filtration  
 - with SAC or RA condensate discharge



## ACCESSORIES

### MOUNTING BRACKET FOR REG.



Code	Description
9200701	Acc. SF 1/4
9400701	Acc. SF 1/2

### PRESSURE GAUGE



Code	Description
9700101	Acc. M 40 1/8 04
9700102	Acc. M 40 1/8 012
9700109	Acc. M 40x40 1/8 04
9700110	Acc. M 40x40 1/8 012
9800101	Acc. M 50 1/8 04
9800102	Acc. M 50 1/8 012
9900101	Acc. M 63 1/4 012

### TIE RODS



Code	Description
9200901	Acc. T 1/4 F+L tie rods
9400901	Acc. T 1/2 F+L tie rods
9600901	Acc. T 3/4 F+L tie rods
9604402	Acc. V3V+F+R 3/4-1 tie rods

### ADAPTER FOR V3V



Code	Description
9201001	Acc. adapt. X V3V+FR/D 1/4
9401001	Acc. adapt. X V3V+D 3/8
9401002	Acc. adapt. X V3V+D 1/2
9601001	Acc. adapt. X V3V+F 1

### REGULATOR CONNECTION BLOCK

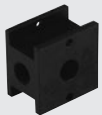

Code	Description
9200501	Acc. BC 1/4 block
9400501	Acc. BC 1/2 block
9600501	Acc. BC 3/4 block

### DISASSEMBLY TOOL FOR BOWL



Code	Description
9601501	Disassembly key

### ASSEMBLY SCREWS (2 PIECES)



Code	Description
9250001	Acc. CVA 1/4 screw M4x40
9250002	Acc. CVA 1/4 screw M4x82 V3V+F+R
9450001	Acc. CVA 1/2 screw M5x55
9450002	Acc. CVA 3/8 1/2 screw M5x60 V3V+R
9450003	Acc. CVA 3/8 1/2 screw M5x120 V3V+F+R
9650001	Acc. CVA 3/4 screw M6x70

### REVERSE PLATE CNOMO CONTROL FOR V3V 3/4"-1"

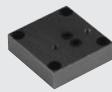

Code	Description
9640201	Reverse plate kit V3V cnomo control

### PLATE FOR REMOTE CONTROL FOR V3V 3/4"-1"

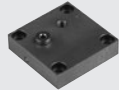

Code	Description
9640001	Remote control plate kit

### REG OR V3V END PLATE

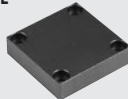

Code	Description
9640101	End plate kit for regulator or V3V

### SPACERS FOR FRL WALL MOUNTING



Code	Description
9200601	Acc. DF 1/4 spacer
9400601	Acc. DF 1/2 spacer
9600601	Acc. DF 3/4 spacer

### MANUAL CONTROL FOR V3V 3/4"-1"



Code	Description
9640401	Manual control kit for V3V

### KEY CONTROL FOR V3V 3/4"-1"



Code	Description
9640301	Key control kit for V3V

### PILOT REGULATOR FOR ND 3/4"-1"



Code	Description
9640501	02 pilot regulator kit
9640502	04 pilot regulator kit
9640503	08 pilot regulator kit
9640504	012 pilot regulator kit

### KIT COIL EEXM



Code	Description
0227606913	Kit for coil 30 24 VDC EEXMT5 cable 3 m
0227606915	Kit for coil 30 24 VDC EEXMT5 cable 5 m
0227608013	Kit for coil 30 24 VAC EEXMT5 cable 3 m
0227608015	Kit for coil 30 24 VAC EEXMT5 cable 5 m
0227608023	Kit for coil 30 110 VAC EEXMT5 cable 3 m
0227608025	Kit for coil 30 110 VAC EEXMT5 cable 5 m
0227608033	Kit for coil 30 230 VAC EEXMT5 cable 3 m
0227608035	Kit for coil 30 230 VAC EEXMT5 cable 5 m

According to ATEX 94/9 CE rule  
 ⚡ II 2G Ex mb IIC T4/T5 Gb  
 ⚡ II 2D Ex tb IIIC T130/T95 °C IP66 Db

### COIL SIDE 22

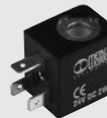

Code	Description
W0215000151	Acc. coil 22 Ø 8 BA 2W-12VDC
W0215000101	Acc. coil 22 Ø 8 BA 2W-24VDC
W0215000111	Acc. coil 22 Ø 8 BA 3.5VA-24VAC
W0215000121	Acc. coil 22 Ø 8 BA 3.5VA-110VAC
W0215000131	Acc. coil 22 Ø 8 BA 3VA-220VAC 50/60 HZ

### "UL" AND "CSA" COIL 22 mm

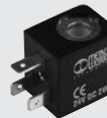

Code	Description
W0215000251	Acc. coil 22 Ø 8 BA 2W-12VDC UR
W0215000201	Acc. coil 22 Ø 8 BA 2W-24VDC UR
W0215000211	Acc. coil 22 Ø 8 BA 3.5VA-24VAC UR
W0215000221	Acc. coil 22 Ø 8 BA 3.5VA-110 VAC UR
W0215000231	Acc. coil 22 Ø 8 BA 3.5VA-220VAC UR

### ELECTRIC CONNECTOR SIDE 22



Code	Description
W0970510011	Acc. connector 22 standard
W0970510012	Acc. connector 22 LED 24V
W0970510013	Acc. connector 22 LED 110V
W0970510014	Acc. connector 22 LED 220V
W0970510015	Acc. connector 22 LED VDR 24V
W0970510016	Acc. connector 22 LED VDR 110V
W0970510017	Acc. connector 22 LED VDR 220V
W0970510070	Acc. connector 22 ATEX II 2 GD

### COIL SIDE 30



Code	Description
W0210010100	Acc. coil 30 Ø 8 2W 24VDC
W0210011100	Acc. coil 30 Ø 8 3.5VA 24VAC 50/60HZ
W0210012100	Acc. coil 30 Ø 8 3.5VA 110VAC 50/60HZ
W0210013100	Acc. coil 30 Ø 8 3.5VA 220VAC 50/60HZ

### ELECTRIC CONNECTOR SIDE 30



Code	Description
W0970520033	Acc. connector 30 STD
W0970520034	Acc. connector 30 LED 24V
W0970520035	Acc. connector 30 LED 110V
W0970520036	Acc. connector 30 LED 220V
W0970520037	Acc. connector 30 VDR 24V
W0970520038	Acc. connector 30 VDR 110V
W0970520039	Acc. connector 30 VDR 220V

### CNOMO CONTROL FOR V3V 3/4"-1"



Code	Description
9453920	Acc. elpn cnomo control kit, manual monostable
9453922	Acc. elpn cnomo control kit, manual bistable

### KIT FOR COIL SIDE 22 IP65



Code	Description
0222100100	Kit for coil 22 - IP65

Improved IP65 protection, even after prolonged exposure to atmospheric agents.  
**Applicable to valves with a technopolymer control.**

## SPARE PARTS

### FILTER AND FILTER REGULATOR FILTERING ELEMENT



Code	Description
9250101	Spare FP 1/4 50
9250102	Spare FP 1/4 20
9250103	Spare FP 1/4 4
9450101	Spare FP 1/2 50
9450102	Spare FP 1/2 20
9450103	Spare FP 1/2 4
9650101	Spare FP 3/4 50
9650102	Spare FP 3/4 20
9650103	Spare FP 3/4 4

### AUTOMATIC DRAIN (SAC)



Code	Description
9000803	Spare SAC automatic drain

### COMPLETE POPPET FOR FILTER REGULATOR



Code	Description
9250901	Spare OTRF 1/4
9450901	Spare OTRF 1/2

### FILTERING ELEMENT FOR DEPURATOR



Code	Description
9450105	Spare kit FP DEP. 3/8 1/2

### SPRINGS FOR REGULATORS AND FILTER REGULATOR



Code	Description
9250601	Spare MO 02 1/4
9250602	Spare MO 04 1/4
9250603	Spare MO 08 1/4
9250604	Spare MO 012 1/4
9450601	Spare MO 04 1/2
9450602	Spare MO 08 1/2
9450603	Spare MO 012 1/2
9650601	Spare MO 04 3/4
9650602	Spare MO 08 3/4
9650603	Spare MO 012 3/4

### COMPLETE POPPER FOR REGULATOR



Code	Description
9250701	Spare OTR 1/4
9450701	Spare OTR 1/2
9650701	Spare OTR 3/4

### VENTURI LUBRICATOR DIAPHRAGM



Code	Description
9252001	Spare MB 100 1/4
9352001	Spare MB 200 1/4 3/8 1/2
9652002	Spare MB 3/4-1

### METAL LUBRICATOR BOWL



Code	Description
9251201	Spare TMVL 1/4
9451201	Spare TMVL 1/2
9651201	Spare TMVL 3/4

### DOME DISASSEMBLY SPANNER



Code	Description
9220701	Acc cover LUB spanner

### METAL FILTER BOWL



Code	Description
9250301	Spare TMVF 1/4 RMSA
9255201	Spare TMVF 1/4 SAC
9450301	Spare TMVF 1/2 RMSA
9455201	Spare TMVF 1/2 SAC
9650301	Spare TMVF 3/4 1 RMSA

### TRANSPARENT LUBRICATOR COVER



Code	Description
9251302	Spare CVL 100-200-300-400 BIT

### POPETT DISASSEMBLY SPANNER (FOR REG)

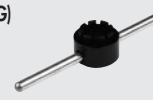

Code	Description
9220501	R cap disass. wr. 100

### AUTOMATIC DRAIN (RA)



Code	Description
9000802	Spare RA automatic drain

### UPPER COVER FOR REGULATOR AND FILTER REGULATOR



Code	Description
9250801	Spare CS 1/4 02
9250802	Spare CS 1/4 04
9250803	Spare CS 1/4 08
9250804	Spare CS 1/4 012
9450801	Spare CS 1/2 04
9450802	Spare CS 1/2 08
9450803	Spare CS 1/2 012
9650801	Spare CS 3/4 04
9650802	Spare CS 3/4 08
9650803	Spare CS 3/4 012



TECHNICAL DATA		1/4"	3/8"	1/2"	3/4"	1"
Flow rate at 6.3 bar (0.6 MPa; 91 psi) $\Delta P$ 0.5 bar (0.05 MPa; 7 psi)	Nl/min scfm	2200 78	2900 102		3600 127	
Flow rate at 6.3 bar (0.6 MPa; 91 psi) $\Delta P$ 1 bar (0.1 MPa; 14 psi)	Nl/min scfm	2400 85	3300 116		4000 141	
Flow rate on discharge at 6 bar (0.1 MPa; 14 psi)	Nl/min scfm			1600 56		
1/4" port flow rate of non-regulated filtered air at 6.3 bar (0.6 MPa; 91 psi) $\Delta p$ 1 bar	Nl/min scfm			1800 64		
* Flow rate of each supplementary 1/4" filtered and regulated air port at 6.3 bar (0.6 MPa; 91 psi) $\Delta P$ 1 bar	Nl/min scfm			2400 85		
Fluid				Compressed air		
Setting range	bar			0.5 to 2 - 0.5 to 4 + 0.5 to 8		
Degree of filtration	$\mu m$			5 (yellow) or 20 (white)		
Operating pressure range	bar MPa psi			10 1 145		
Operating temperature range	$^{\circ}C$ $^{\circ}F$			-10 to 50 -14 to 122		
Class of protection				IP 65 with connector		
Insulation class of the solenoid valve				F155		
Switching time				100% ED		
Electrical connector				M12 x 1.5-pin to CEI IEC 60947-5-2		
Solenoid valve power	W			3/0.3		
Solenoid valve voltage	V			24 VDC $\pm$ 10%		
Pressure interval settable on the pressure switch	bar			0.5 to 10		
Pressure switch hysteresis (not adjustable)	bar			0.4 to 0.8		
Maximum pressure switch current	A			0.5		
Maximum pressure switch voltage	V			3 to 30 AC/DC		
Pressure switch contacts				Normally open (NO) and normally closed (NC)		
Number of switching				5 x 10 <sup>6</sup>		
Weight	kg			From 1.15 to 1.25 according to configurations		
Wall fixing (max. panel thickness 10 mm)				Front, with M5 x 75 screws or back, with M6 x 70 screws The screws are included in the supply		
Mounting position				Vertical		
Direction of flow				From left to right		
* Total flow rate from two supplementary outlets and the main one cannot exceed 4000 Nl/min at 6.3 bar with $\Delta P=1$						

## HOW TO ORDER

### ORDERING CODES

You can choose among numerous variants and options. The product code so personalised is made up by compiling the diagram below. The code so compiled must be specified on the order. A label showing the code and its pneumatic diagram is affixed onto the product.

	<b>A</b>	<b>B</b>	<b>C</b>	<b>D</b>	<b>E</b>	<b>F</b>	<b>G</b>	<b>H</b>	<b>I</b>	<b>L</b>	
	ONE electric or ONE non-electric	Air intake	Degree of filtration	Clogged filter signal	Condensate drain	Pressure regulation	Valves	Pressure switch	Air outlet	Miscellaneous, special version	
<b>EXAMPLE</b>	<b>54</b>	<b>3</b>	<b>2</b>	<b>1</b>	<b>1</b>	<b>2</b>	<b>7</b>	<b>1</b>	<b>3</b>	<b>0</b>	<b>0</b>
<b>53</b>	ONE non-electric	1 1/4"	2 20 µm	0 NO	0 RMSA	2 0.5 to 2 bar	0 None	0 NO	1 1/4"	00	Standard
<b>54</b>	ONE electric *	2 3/8"	5 5 µm	1 YES	1 auto-matic (RA)	4 0.5 to 4 bar	1 V3V manual	1 YES	2 3/8"		
		3 1/2"				8 0.5 to 8 bar	2 V3V manual with padlock		3 1/2"		
		4 3/4"					3 V3V manual and soft start valve		4 3/4"		
		5 1"					4 V3V manual with padlock and soft start valve		5 1"		
							5 V3V manual and V3V electric				
							6 V3V manual with padlock and V3V electric				
							7 V3V manual and APR electric				
							8 V3V manual with padlock and APR electric				
							9 only V3V electric				
							A only APR electric				

\* a pressure switch version and/or electric V3V and/or electric progressive actuator.

● **NB: versions valid only for the electric ONE (code 54...)**

- A ONE electric or non-electric**  
**ONE non-electric:** there is no component actuated electrically: select code 53. In this case, the unit comes without any M12x1 connector, LED, pressure switch, or electric V3V.  
**ONE electric:** there is at least one component actuated electrically, and thus the pressure switch and/or electric V3V (and/or the electrical soft start valve) select code 54. In this case, the unit comes with the M12x1 connector and 3 LEDs. Only the LEDs associated with the functions installed will be active.
- B Air intake**  
 There are 5 different gas cylindrical threads: 1/4", 3/8", 1/2", 3/4" and 1".
- C Degree of filtration**  
 A cartridge with a degree of filtering of 5 µm (yellow) or 20 µm (white) is available. This value is marked on the plug.
- D Clogged filter signal**  
 If the filter gets so clogged up that it causes an excessive drop in pressure as the air passes through, the orange indicator will project from the body by a few millimetres.
- E Condensate drain**  
**RMSA:** the condensate is drained out automatically only by relieving the air pull the knurled knob for having the same result.  
**Automatic (RA):** a floating system that automatically drains the condensate out whenever the level of water in the bowl reaches the set value.
- F Pressure regulation**  
 There are three possible regulation fields.  
 The value is marked on the regulation knob.
- G Valves**  
 There are 11 different combinations. The electric valves are clearly selectable only if the initial code is 54, i.e. ONE electric.
- 0 - No valves present
  - 1 - V3V manual: is a 3/2 valve that in a set position allows the air to flow and in the other it closes the passage and discharges the pressure downstream.
  - 2 - V3V manual with padlock: like the previous one, with the possibility of inserting a padlock (included in the supply with 2 keys) in the valve closed position.
  - 3 - V3V manual and soft start valve: when the manual V3V valve is operated, the pressure starts to increase slowly, with a fine adjustable ramp, and when it reaches about 30-40% of the set value, the valve opens completely and the pressure rises to the set value.
  - 4 - V3V manual with padlock and soft start valve: like the previous, with the padlock device on the manual V3V in "OFF" position.
  - 5 - V3V manual and V3V electric: two V3V in series are present, one is manual the other electrical. By operating both the valve the air flow is allowed. If one or two are switched OFF, the air downstream is relieved. The electrical one can also be operated manually by reefing pushed the "TEST" button
  - 6 - V3V manual with padlock and V3V electric: like the previous, with the padlock device in "OFF" position.
  - 7 - V3V manual and APR electric: One manual V3V and one soft start valve are present. When both are operated, the pressure starts to increase slowly, with a fine adjustable ramp, and when it reaches about 30-40% of the set value, the valve opens completely and the pressure rises to the set value.
  - 8 - V3V manual with padlock and APR electric: like the previous, with the padlock device on the manual V3V in "OFF" position.
  - 9 - V3V electric: It's present only the electrical V3V. The valve will open if it is powered on. When the power supply is switched off, the valve closes and air downstream is relieved. The valve can also be operated manually by keeping pushed the test button.
  - A - APR electric: It's present only the electric soft start valve. When it is powered ON, the pressure starts to increase slowly, with a fine adjustable ramp, and when it reaches about 30-40% of the set value, the valve opens completely and the pressure rises to the set value.
- H Pressure switch**  
 The pressure switch has a switching contact, which means you can have a normally-open signal or a normally-close signal. It is also connected to the NC and NO LEDs which come on if the actual pressure is less or greater than the set pressure, respectively. The LEDs only come on if an electric charge is connected to them.
- I Air outlet**  
 Five different gas cylindrical threads are available: 1/4", 3/8", 1/2", 3/4" and 1". It is possible to choose a thread other than the one on the inlet port.
- L Free positions for special executions.**

## ACCESSORIES

### PANEL MOUNTING BRACKETS

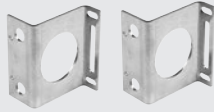

Code	Description
9200702	Kit – panel mounting brackets NB: fixing screws included

### STRAIGHT CONNECTOR



Code	Description
W0970513001	Acc. 5-PIN M12X1 straight connector

### SECURITY KNOB



Code	Description
9200703	Acc. security knob apr/pressure switch

### COVER DISASSEMBLY WRENCH



Code	Description
9170401	Cover disassembly wrench

### 90° CONNECTOR WITH WIRE



Code	Description
W0970513004	Acc. M12X1 5-PIN 90° connector with wire L = 5 m

### STRAIGHT CONNECTOR WITH WIRE



Code	Description
W0970513002	Acc. 5-PIN M12X1 straight connector with wire L = 5 m

### 90° CONNECTOR



Code	Description
W0970513003	Acc. M12X1 5-PIN 90° connector

## SPARE PARTS

### PRESSURE GAUGE



Code	Description
9700106	M 39 1/8 0-4
9700107	M 39 1/8 0-12

### FILTER PLUG WITH FILTER ELEMENT



Code	Description
9251723	Spare plug + filter element 5 µm ONE
9251724	Spare plug + filter element 20 µm ONE

### PRESSURE SWITCH



Code	Description
9000500	Spare press. switch for ONE

### FILTER ELEMENT



Code	Description
9251720	Spare filter element 5 µm for ONE
9251721	Spare filter element 20 µm for ONE

### POPPE



Code	Description
9250707	Spare poppet for ONE

### ELECTRIC BOARD



Code	Description
9232010	Spare electric board for ONE

### PILOT REGULATOR



Code	Description
9250820	Spare pilot reg. 0.5 to 2 bar for ONE
9250821	Spare pilot reg. 0.5 to 4 bar for ONE
9250822	Spare pilot reg. 0.5 to 8 bar for ONE

### SOLENOID VALVE



NEW

Code	Description
722123840101	PLT-10 722123840101

### AUTOMATIC DRAIN (RA)



Code	Description
9000802	Spare RA automatic drain

### THREADED PORT



Code	Description
9232001	Spare 1/4" thr. port for ONE
9232002	Spare 3/8" thr. port for ONE
9232003	Spare 1/2" thr. port for ONE
9232004	Spare 3/4" thr. port for ONE
9232005	Spare 1" thr. port for ONE



OLD

Note: Spare part no longer available. If the solenoid valve to be replaced is the same as the one shown here on the left, please contact our sales department.



## PROPORTIONAL PRECISION PRESSURE REGULATOR "REGTRONIC" SERIES

REGTRONIC M5



REGTRONIC 1/8"-1/4"



REGTRONIC New deal



REGTRONIC 300



REGTRONIC 400



TECHNICAL DATA	REGTRONIC			REGTRONIC NEW DEAL		REGTRONIC 300			REGTRONIC 400			
	M5	1/8"	1/4"	3/4"	1"	1/2"	3/4"	1"	1"	1 1/4"	1 1/2"	2"
Threaded ports												
Fluid	Filtered, unlubricated air. The air must be filtered at least 10 µm Regulation pressure +1 bar											
MIN inlet pressure	bar											
MAX inlet pressure	bar											
Temperature range	°C											
Pressure regulation range	bar											
Flow rate at 6.3 bar ΔP 0.5 bar	NI/min											
Flow rate at 6.3 bar ΔP 1 bar	NI/min											
Exhaust flow rate at 6.3 bar with 0.1 bar overpressure	NI/min											
Exhaust flow rate at 6.3 bar with 0.5 bar overpressure	NI/min											
Weight	kg											
Class of protection	IP 65											
Power supply	24 Vcc +10% -5% I max 110 mA											
Input signal (input impedance)	Voltage Current 0 to 5 Vcc, 0 to 10 Vcc (approx. 6.3 KΩ) 4 to 20 mA (approx. 100 Ω)											
	Serial ports RS 232 Manual Keypad											
Output signal	Analog Digital 0 to 10 Vcc (1 V=1bar) - 1 mA max PNP open collector output: max 24V 60 mA NPN open collector output: max 24V 60 mA											
Linearity	≤ ± 0.5% (Full scale)											
Hysteresis	≤ ± 0.2% (Full scale)											
Repeatability	≤ ± 0.2% (Full scale)											
Sensitivity/Dead-band	setting range 10 to 100 mbar											
Output pressure display	Accuracy Unit of measurement Minimum resolution ≤ ± 0.3% (Full scale) bar, MPa, psi 0.01 bar - 0.001 MPa - 0.01 psi ≤ ± 0.4% (Full scale) max 2 mbar / °C											
Analog output accuracy												
Temperature characteristics												
Response time with ΔP = 1 bar												
from 6 to 7 bar	volume 100 cc			volume 1000 cc								
from 7 to 6 bar	0.5	0.2	0.3	0.45	0.35							
Installation position	0.55	0.3	0.3	0.45	0.7							
Note	in any position The features shown refer to the static condition only. With air consumption on the output side, the pressure may vary.											

UNITS

PROPORTIONAL PRECISION PRESSURE REGULATOR "REGTRONIC" SERIES

### ORDERING CODES

#### REGTRONIC M5; 1/8"; 1/4"

Code	Description
5520500	REGTRONIC M5 with display
5520502	REGTRONIC M5 remote control
5521500	REGTRONIC 1/8" with display
5521502	REGTRONIC 1/8" remote control
5522500	REGTRONIC 1/4" with display
5522502	REGTRONIC 1/4" remote control

#### REGTRONIC New deal

Code	Description
1520003	REGTRONIC 3/4" with display
1520004	REGTRONIC 3/4" remote control
1620003	REGTRONIC 1" with display
1620004	REGTRONIC 1" remote control

#### REGTRONIC 300

Code	Description
4402012A	REGTRONIC 300 with display without end plates
4402013A	REGTRONIC 300 remote control without end plates
4402012	REGTRONIC 300 1/2" with display
4402013	REGTRONIC 300 1/2" remote control
4502012	REGTRONIC 300 3/4" with display
4502013	REGTRONIC 300 3/4" remote control
4602012	REGTRONIC 300 1" with display
4602013	REGTRONIC 300 1" remote control

#### REGTRONIC 400

Code	Description
6102012A	REGTRONIC 400 with display without end plates
6102013A	REGTRONIC 400 remote control without end plates
6102012	REGTRONIC 400 1" with display
6102013	REGTRONIC 400 1" remote control
6202012	REGTRONIC 400 1" 1/4 with display
6202013	REGTRONIC 400 1" 1/4 remote control
6302012	REGTRONIC 400 1" 1/2 with display
6302013	REGTRONIC 400 1" 1/2 remote control
6402012	REGTRONIC 400 2" with display
6402013	REGTRONIC 400 2" remote control

### ACCESSORIES

#### M12x1 PRE-WIRED 8-PIN FEMALE STRAIGHT CONNECTOR

Code	Description
W0970513010	Acc. M12X1 pre-wired 8-PIN straight connector, cable L = 5 m

#### M12x1 PRE-WIRED 8-PIN FEMALE 90° CONNECTOR

Code	Description
W0970513011	Acc. M12X1 pre-wired 8-PIN 90° connector, cable L = 5 m

#### CONFIGURATION CABLE

Code	Description
W097053019	Cable configuration Regtronic

#### FIXING BRACKET KIT FOR REGTRONIC

Code	Description
9200710	Acc. fixing bracket kit for 1/8" - 1/4"
9200711	Acc. fixing bracket kit for M5

## PRECISION PRESSURE REGULATOR WITH HIGH EXHAUST FLOW, SERIE GS



TECHNICAL DATA	1/8"	1/4"
Threaded port	1/8"	1/4"
Setting range	0 to 2 - 0 to 4 - 0 to 8	
Max. input pressure	10	
Flow rate at 6.3 bar ΔP 0.5 bar	900	1170
Flow rate at 6.3 bar ΔP 1 bar	1200	1380
Fluid	Unlubricated filtered air. The air must be at least 10 μm pre-filtered	
Temperature range	From -10 to +50	
Mounting position	In any position	
Pressure gauge port	G 1/8"	
Weight	600	
Exhaust flow rate at 4 bar (regulated pressure)		
ΔP 0.1 bar	450	810
ΔP 0.5 bar	900	1190
Variation in regulated pressure (2 bar) with changes in upstream pressure (4-10 bar)	± 20	
Relieving sensitivity	30	
Air consumption – continuous escape	< 0.1	
Notes	The regulator pressure must always be set upwards. For increased sensitivity, use a pressure regulator with a rated pressure as close as possible to the required value. <b>Do not take air from pressure gauge ports.</b>	

Code	Description	Code	Description	Code	Description
5511200	REG. GS 1/8 02	5511400	REG. GS 1/8 08	5512300	REG. GS 1/4 04
5511300	REG. GS 1/8 04	5512200	REG. GS 1/4 02	5512400	REG. GS 1/4 08

### ACCESSORIES

#### PRESSURE GAUGE

Code	Description
9700101	Acc. M 40 1/8 04
9700102	Acc. M 40 1/8 012
9700109	Acc. M 40x40 1/8 04
9700110	Acc. M 40x40 1/8 012

#### R/FR FIXING BRACKET

Code	Description
9200701	Acc. SF100 - BIT - ND 1/4 - SY1

#### FIXING BRACKET KIT

Code	Description
9200710	Acc. fixing bracket kit

### SPARE PARTS

#### UPPER COVER FOR REG GS

Code	Description
9250835	Spares CS REG GS 02
9250836	Spares CS REG GS 04
9250837	Spares CS REG GS 08

## PRESSURE SWITCHES



TECHNICAL DATA	
Adjustable pressure interval	bar 0.5 to 10
Hysteresis (not adjustable)	bar from 0.4 to 0.8
Maximum pressure	bar 15
	MPa 1.5
	psi 217
Operating temperature range at: 1 MPa; 10 bar; 145 psi	°C 50
	°F 122
Lower threaded port	R 1/8"
Maximum current	A 2
Maximum voltage	V 250
Outside diameter of cable	mm 4.9
Number of wires and cross section	3 x 0.5 mm <sup>2</sup>
Contacts	Normally-Open (NO) and Normally-Closed (NC)
Protection	IP65
Number of switchings	5 x 10 <sup>6</sup>
Fluid	Filtered lubricated or unlubricated compressed air. Lubrication, if used, must be continuous
Mounting position	In any position.
Weight	kg 0.121

### ACCESSORIES

#### M8 STRAIGHT CONNECTOR WITH CABLE

Code	Description	Code	Description	Code	Description
9000401	1/8 2A NO/NC pressure switch, 2-metre cable	02400A0100	M8 female 3 PIN HIGH FLEX CL6 connector with cable L = 1 m	9200703	Acc. security knob
9000402	1/8 2A NO/NC pressure switch, M8 connector	02400A0250	M8 female 3 PIN HIGH FLEX CL6 connector with cable L = 2.5 m		
		02400A0500	M8 female 3 PIN HIGH FLEX CL6 connector with cable L = 5 m		
		02400A1000	M8 female 3 PIN HIGH FLEX CL6 connector with cable L = 10 m		
			Mobile laying cable, class 6 according to IEC 60228		

## DIGITAL PRESSURE SWITCH

SERIES 600



SERIES 640



TECHNICAL DATA		SERIES 600	SERIES 640
Working pressure range	bar		-1 to 10
	MPa		-0.1 to 1
Maximum admissible pressure	bar		15
	MPa		1.5
Readable resolution	bar		0.01
	MPa		0.001
	kg/cm <sup>2</sup>		0.01
	psi		0.1
Power supply	VDC	12 to 24 ± 10%, max ripple 10%	
Current consumption	mA	≤ 55	≤ 40
Digital outputs		2 type PNP, with max current 80 mA, max voltage 24 VDC; residual voltage ≤ 1V (at 80 mA)	2 type PNP, with max current 125 mA, max voltage 24 VDC; residual voltage ≤ 1.5 V (at 125 mA)
Digital output repeatability		≤ ±0,2 % full scale ± 1 digits	
Hysteresis		Adjustable or fixed at 3 digits for operation within a pressure range	
Actuation response time	ms	≤ 2.5	
Interference suppression selectable at	ms	24, 192, 768	25, 100, 250, 500, 1000, 1500
Short-circuit protection at the outputs		Yes	
LED 7 segment display		3 ½ digit display	
Display colours		red	red/green
Display accuracy		±2% full scale ± 1 digit, ambient temperature 25° ± 3°C	
Indicators		green LED (output 1), red LED (output 2)	orange LED (output 1 and output 2)
Analogue output		1-5 V ± 2.5 % (0 bar - 1V; 10 bar - 5V; it doesn't read the vacuum)	
		Linearity ≤ 1% full scale	
		Output impedance: about 1 kΩ	
Thermal characteristic		≤ ±2% full scale of the calibration pressure (at 25°C), in the temperature range 0 - 50°C	
Compressed air ports		2 G1/8" female thread	1 R1/8" male taper thread (M5 female inside)
Power cable		2 m, with five 0.15 mm <sup>2</sup> wires, oil-resistant	
Certifications		pre-wired cable, not removable	removable connector
Weight	g	105, including 2 m cable	86, including 2 m cable
<b>AMBIENT CONDITIONS</b>			
Fluid		Filtered and unlubricated air, inert non-corrosive and non-explosive gas	
Degree of protection		IP 40 - IP65 (with accessory protection assembled)	
Temperature range	°C	0 to 50	
Storage temperature	°C	-20 to +60, but without condensate or ice	-10 to +60, but without condensate or ice
Ambient humidity		35 to 85% relative humidity; no condensate	
Insulation voltage		1000 VAC for one minute between casing and cable	
Resistance of Insulation		Min. 50 MΩ minimo (at 500 VDC between casing and cable)	
Vibration admitted		1.5 mm amplitude or 10G with scanning every minute from 10 to 55 Hz at 10 Hz, for 2 hours in each direction x, y and z	
Impact		980 m/s <sup>2</sup> (100 g), 3 times in each direction x, y and z   100 m/s <sup>2</sup> (10 g), 3 times in each direction x, y and z	

### SERIES 600

Code	Description
9000600	Digital pressure switch series 600

### SERIES 640

Code	Description
9000640	Digital pressure switch series 640

## ACCESSORIES SERIES 600

### FIXING BRACKET KIT

Code	Description
9000601	Kit of fixing brackets for digital pressure switches series 600

NB: Each kit contains a bracket for fixing on the back and one for fixing at the bottom.

### PANEL FIXING KIT

Code	Description
9000602	Kit for panel fixing for the digital pressure switch series 600

### PANEL FIXING KIT WITH VIDEO SCREEN

Code	Description
9000603	Kit for panel fixing with screen for the digital pressure switch series 600

## ACCESSORIES SERIES 640

### PARALLEL FIXING BRACKET KIT

Code	Description
9000641	Parallel fixing bracket kit for digital pressure switch series 640

### 90° FIXING BRACKET KIT

Code	Description
9000644	90° fixing bracket kit for digital pressure switch series 640

### PANEL FIXING KIT

Code	Description
9000642	Kit for panel fixing for the digital pressure switch series 640

### PANEL FIXING KIT WITH VIDEO SCREEN

Code	Description
9000643	Kit for panel fixing with screen for the digital pressure switch series 640

## PUSH-IN FITTINGS

TECHNICAL DATA	METRIC or G (BSP) *	UNF or NPT **
Threaded coupling	Metric: M3 - M5 - M7 - M12x1.5 G (BSP): 1/8 - 1/4 - 3/8 - 1/2	UNF: 10-32 NPT: 1/8 - 1/4 - 3/8 - 1/2
Diameter of the pipe	3 - 3.17 - 4 - 5 - 6 - 8 - 10 - 12 - 14	1/8 - 5/32 - 1/4 - 5/16 - 3/8 - 1/2
Temperature range for brass fittings °C		-20 to +80
Temperature range for brass fittings °F		-4 to 176
Temperature range for technopolymer fittings °C		-20 to +60
Temperature range for technopolymer fittings °F		-4 to 140
Pressure range for brass fittings		-0.99 bar to 16 bar / -0.099 MPa to 1.6 MPa
Pressure range for technopolymer fittings		-0.99 bar to 12 bar / -0.099 MPa to 1.2 MPa
Recommended pipe		Rilsan PA 11 - Nylon 6 - Polyamide 12 - Polypropylene
Fluid		Vacuum - Compressed air

\* Metric cylindrical threads according to ISO 262  
Cylindrical threads according to ISO 228-1, identified with a letter G. They also correspond to BSP or more precisely to BSPP designation (P stands for Parallel).  
Conical threads according to ISO 7-1, identified by a letter G. They also correspond to BSP or more precisely to BSPT designation (T stands for Tapered).

\*\* UNF cylindrical threads, according to ANSI B 1.1  
NPT conical threads. Female threads are in accordance with ANSI B 1-20, male threads are a Metal Work specifically designed solution that is compatible with ANSI B 1-20 threads.

## BRASS PUSH-IN FITTINGS FOR mm TUBES AND G (BSP) or METRIC THREAD

### STRAIGHT, CYLINDRICAL, MALE (R1)



Code	Ref.	Ø	Thread	Quantity
2001B01	R1	3	M3	50
2001B02	R1	3	M5	50
2001A01	R1	3.17	M3	25
2001A02	R1	3.17	M5	25
2L01001	RL1	4	M5	50
2L01020	RL1	4	M7	50
2L01002	RL1	4	1/8	50
2L01003	RL1	4	1/4	50
2001004	R1	5	M5	50
2001005	R1	5	1/8	50
2001006	R1	5	1/4	50
2L01000	RL1	6	M5	50
2L01021	RL1	6	M7	50
2L01101	RL1	6	M12x1.5	50
2L01007	RL1	6	1/8	50
2L01008	RL1	6	1/4	50
2L01102	RL1	8	M12x1.5	50
2L01009	RL1	8	1/8	50
2L01010	RL1	8	1/4	50
2L01011	RL1	8	3/8	50
2L01012	RL1	10	1/4	50
2L01013	RL1	10	3/8	50
2L01018	RL1	10	1/2	25
2001019	RL1	12	1/4	25
2001014	RL1	12	3/8	25
2001015	RL1	12	1/2	25
2001016	RL1	14	3/8	25
2001017	RL1	14	1/2	25

### STRAIGHT, FEMALE (R2)



Code	Ref.	Ø	Thread	Quantity
2002B02	R2	3	M5	50
2002A02	R2	3.17	M5	50
2L02001	RL2	4	1/8	50
2L02002	RL2	4	1/4	50
2002003	R2	5	1/8	50
2002004	R2	5	1/4	50
2L02005	RL2	6	1/8	50
2L02006	RL2	6	1/4	50
2L02007	RL2	8	1/8	50
2L02008	RL2	8	1/4	50
2L02009	RL2	10	1/4	50
2L02010	RL2	10	3/8	50
2L02011	RL2	12	3/8	25
2L02012	RL2	12	1/2	25

### ELBOW, INTERMEDIATE (R4)



Code	Ref.	Ø	Quantity
2004A02	R4	3	50
2004A01	R4	3.17	50
2L04001	RL4	4	50
2004002	R4	5	50
2L04003	RL4	6	50
2L04004	RL4	8	50
2L04005	RL4	10	50
2004006	RL4	12	25
2004007	RL4	14	20

### THREADED ADAPTER (R6)



Code	Ref.	Ø	Thread	Quantity
2006A02	R6	3	M5	100
2006A01	R6	3.17	M5	25
2006001	R6	4	M5	50
2006020	R6	4	M7	50
2006002	R6	4	1/8	50
2006003	R6	4	1/4	50
2006004	R6	5	M5	50
2006005	R6	5	1/8	50
2006006	R6	5	1/4	50
2006000	R6	6	M5	50
2006021	R6	6	M7	50
2006007	R6	6	1/8	50
2006008	R6	6	1/4	50
2006009	R6	8	1/8	50
2006010	R6	8	1/4	50
2006011	R6	8	3/8	50
2006012	R6	10	1/4	50
2006013	R6	10	3/8	50
2006022	R6	10	1/2	25
2006019	R6	12	1/4	25
2006014	R6	12	3/8	25
2006015	R6	12	1/2	25
2006016	R6	14	3/8	25
2006017	R6	14	1/2	25
2006101	R6	6	M12x1.5	50
2006102	R6	8	M12x1.5	50

### STRAIGHT, CONICAL, MALE (R1C)



Code	Ref.	Ø	Thread	Quantity
2L01C02	RL1C	4	1/8	50
2L01C07	RL1C	6	1/8	50
2L01C08	RL1C	6	1/4	50
2001Z07	RL1Z	6	12x1 conical	50
2001Z08	RL1Z	6	12x1.25 conical	50
2L01C09	RL1C	8	1/8	50
2L01C10	RL1C	8	1/4	50
2L01C11	RL1C	8	3/8	50
2L01C13	RL1C	10	1/4	50
2L01C14	RL1C	10	3/8	50
2001C15	RL1C	12	3/8	25
2001C16	RL1C	12	1/2	25

### STRAIGHT, INTERMEDIATE (R3)



Code	Ref.	Ø 1	Ø 2	Quantity
2003A02	R3	3	3	50
2003A01	R3	3.17	3.17	50
2L03001	RL3	4	4	50
2003002	R3	5	5	50
2L03003	RL3	6	6	50
2L03004	RL3	8	8	50
2L03005	RL3	10	10	50
2003006	RL3	12	12	25
2003007	RL3	14	14	25
2L03301	RL3	4	6	50
2L03302	RL3	4	8	50
2L03303	RL3	6	8	50
2L03304	RL3	6	10	50
2L03306	RL3	6	12	50
2L03305	RL3	8	10	25
2L03307	RL3	8	12	25
2L03308	RL3	10	12	25

### TEE, INTERMEDIATE (R5)



Code	Ref.	Ø	Quantity
2005A02	R5	3	50
2005A01	R5	3.17	50
2L05001	RL5	4	50
2005002	R5	5	50
2L05003	RL5	6	50
2L05004	RL5	8	50
2L05005	RL5	10	20
2005006	RL5	12	20
2005007	RL5	14	10

### EXTENDED THREADED ADAPTER (R18)



Code	Ref.	Ø	Thread	Quantity
2018002	R18	4	1/8	50
2018007	R18	6	1/8	50
2018008	R18	6	1/4	50
2018009	R18	8	1/8	50
2018010	R18	8	1/4	50
2018011	R18	8	3/8	25
2018012	R18	10	1/4	50
2018013	R18	10	3/8	25

**EXTENSION (R7)**

Code	Ref.	Ø	Quantity
2007001	R7 4		100
2007002	R7 5		50
2007003	R7 6		50
2107004	RL7 8		50
2007005	R7 10		25
2007006	R7 12		20
2007007	R7 14		50

**STRAIGHT, INTERMEDIATE, BULKMTAD (R10)**

Code	Ref.	Ø 1	Ø 2	Thread	Quantity
2011A02	R10 3 3			M8x0.75	50
2011A01	R10 3.17 3.17			M8x0.75	50
2111001	RL10 4 4			M11x1	50
2011002	R10 5 5			M14x1	50
2111003	RL10 6 6			M13x1	50
2111004	RL10 8 8			M15x1	50
2111005	RL10 10 10			M17x1	25
2011006	RL10 12 12			M20x1	25
2011007	RL10 14 14			M24x1	25

2111301	RL10 4 6			M13x1	50
2111302	RL10 4 8			M15x1	50
2111303	RL10 6 8			M15x1	50
2111304	RL10 6 10			M17x1	50
2111306	RL10 6 12			M20x1	25
2111305	RL10 8 10			M17x1	25
2111307	RL10 8 12			M20x1	25
2111308	RL10 10 12			M20x1	25

**ROD, MALE SINGLE ROTARY RING (R15)**

Code	Ref.	Ø	Thread	Quantity
2014101	R15 3		M3	100
2014102	R15 3.17		M3	25
2014103	R15 3		M5	25
2014104	R15 3.17		M5	25
2114001	RL15 4		M5	50
2114020	RL15 4		M7	50
2114002	RL15 4		1/8	50
2014003	R15 5		M5	50
2014004	R15 5		1/8	50
2114106	RL15 6		M5	50
2114021	RL15 6		M7	50
2114005	RL15 6		1/8	50
2114007	RL15 6		1/4	50
2114006	RL15 8		1/8	50
2114008	RL15 8		1/4	50
2114013	RL15 8		3/8	50
2114009	RL15 10		1/4	25
2114014	RL15 10		3/8	25
2014010	RL15 12		1/4	20
2014011	RL15 12		3/8	50
2014012	RL15 12		1/2	25

**ROTARY ELBOW, MALE, CYLINDRICAL (R31)**

Code	Ref.	Ø	Thread	Quantity
2131001	RL31 4		M5	50
2131002	RL31 4		1/8	50
2131003	RL31 4		1/4	50
2031004	R31 5		M5	50
2031005	R31 5		1/8	50
2031006	R31 5		1/4	50
2131007	RL31 6		M5	50
2131008	RL31 6		1/8	50
2131009	RL31 6		1/4	50
2131010	RL31 8		1/8	50
2131011	RL31 8		1/4	50
2131012	RL31 8		3/8	50
2131013	RL31 10		1/4	50
2131014	RL31 10		3/8	25
2031015	RL31 10		1/2	25
2031016	RL31 12		1/4	25
2031017	RL31 12		3/8	25
2031018	RL31 12		1/2	25
2031019	RL31 14		1/2	20

**REDUCER (R8)**

Code	Ref.	Ø 1	Ø 2	Quantity
2008A01	R8 4 3			50
2008A02	R8 4 3.17			50
2008001	RL8 5 4			50
2108002	RL8 6 4			50
2008003	R8 6 5			50
2108004	RL8 8 4			50
2008005	R8 8 5			50
2108006	RL8 8 6			50
2108007	RL8 10 6			50
2108008	RL8 10 8			50
2008009	RL8 12 4			25
2008010	RL8 12 6			25
2008011	RL8 12 8			25
2008015	RL8 12 10			25
2008014	RL8 14 8			25
2008017	RL8 14 10			25
2008018	RL8 14 12			25

ADDITION				
2009001	RL8/M	4	6	50

**SINGLE RING (R13)**

Code	Ref.	Ø	Ø FOR:	Quantity
2012A02	RT3 3		M5	25
2012A01	RT3 3.17		M5	50
2012001	RL13 4		M5	50
2012002	RL13 4		1/8	50
2012003	RL13 5		M5	50
2012004	RL13 5		1/8	50
2012005	RL13 6		1/8	50
2012006	RL13 6		1/4	50
2012007	RL13 8		1/8	50
2012008	RL13 8		1/4	50
2012009	RL13 8		3/8	50
2012010	RL13 10		1/4	50
2012011	RL13 10		3/8	50
2012013	RL13 12		1/4	25
2012012	RL13 12		3/8	25
2012014	RL13 12		1/2	25

For the rods series D

**ROD, MALE DUAL ROTARY RING (R16)**

Code	Ref.	Ø	Thread	Quantity
2115001	RL16 4		M5	50
2115020	RL16 4		M7	50
2115002	RL16 4		1/8	50
2015003	R16 5		M5	50
2015004	R16 5		1/8	50
2115106	RL16 6		M5	50
2115021	RL16 6		M7	50
2115005	RL16 6		1/8	50
2115007	RL16 6		1/4	25
2115006	RL16 8		1/8	50
2115008	RL16 8		1/4	25
2115013	RL16 8		3/8	25
2115009	RL16 10		1/4	25
2115014	RL16 10		3/8	25
2015010	RL16 12		1/4	25
2015011	RL16 12		3/8	20
2015012	RL16 12		1/2	10

**ROTARY ELBOW, MALE, CONICAL (R31C)**

Code	Ref.	Ø	Thread	Quantity
2131C02	RL31/C 4		1/8	50
2131C03	RL31/C 4		1/4	50
2131C08	RL31/C 6		1/8	50
2131C09	RL31/C 6		1/4	50
2131C10	RL31/C 8		1/8	50
2131C11	RL31/C 8		1/4	50
2131C12	RL31/C 8		3/8	50
2131C13	RL31/C 10		1/4	25
2131C14	RL31/C 10		3/8	25
2031C15	RL31/C 12		3/8	25
2031C16	RL31/C 12		1/2	25

**PLUG (R9)**

Code	Ref.	Ø	Material	Quantity
2010A02	R9 3		Brass	100
2110A01	RL9T 3.17		Technopol.	50
2110001	RL9T 4		Technopol.	50
2010002	R9 5		Brass	50
2110003	RL9T 6		Technopol.	50
2110004	RL9T 8		Technopol.	50
2110005	RL9T 10		Technopol.	50
2110006	RL9T 12		Technopol.	50
2010007	R9 14		Brass	25

**DUAL RING (R14)**

Code	Ref.	Ø	Ø FOR:	Quantity
2013001	RL14 4		M5	25
2013002	RL14 4		1/8	25
2013003	RL14 5		M5	25
2013004	RL14 5		1/8	50
2013005	RL14 6		1/8	50
2013006	RL14 6		1/4	50
2013007	RL14 8		1/8	50
2013008	RL14 8		1/4	50
2013009	RL14 8		3/8	25
2013010	RL14 10		1/4	25
2013011	RL14 10		3/8	20

For the rods series D

**CENTRAL TEE, MALE, CYLINDRICAL, ROTARY (R32)**

Code	Ref.	Ø	Thread	Quantity
2132001	RL32 4		M5	50
2132002	RL32 4		1/8	50
2132003	RL32 4		1/4	50
2032005	R32 5		1/8	50
2132004	RL32 6		M5	50
2132008	RL32 6		1/8	50
2132009	RL32 6		1/4	50
2132010	RL32 8		1/8	50
2132011	RL32 8		1/4	50
2132012	RL32 8		3/8	50
2132013	RL32 10		1/4	25
2132014	RL32 10		3/8	25
2032017	RL32 12		3/8	20
2032018	RL32 12		1/2	20
2032019	RL32 14		1/2	10



**CENTRAL TEE, MALE, CONICAL, ROTARY (R32C)**

Code	Ref.	Ø	Thread	Quantity
2L32C02	RL32/C	4	1/8	50
2L32C03	RL32/C	4	1/4	50
2L32C08	RL32/C	6	1/8	50
2L32C09	RL32/C	6	1/4	50
2L32C10	RL32/C	8	1/8	50
2L32C11	RL32/C	8	1/4	50
2L32C12	RL32/C	8	3/8	50
2L32C13	RL32/C	10	1/4	25
2L32C14	RL32/C	10	3/8	25

**CROSS FITTING (R40)**

Code	Ref.	Ø	Quantity
2L40001	RL40	4	10
2L40003	RL40	6	10
2L40004	RL40	8	10

**TRIPLE ROD SINGLE ROTARY RINGS (R52)**

Code	Ref.	Ø	Thread	Quantity
2L52002	RL52	4	1/8	25
2L52008	RL52	6	1/8	25
2L52009	RL52	6	1/4	25
2L52010	RL52	8	1/8	25
2L52011	RL52	8	1/4	25
2L52013	RL52	10	1/4	10

**MALE ROD, DUAL SWIVEL RING (R55)**

Code	Ref.	Ø	Thread	Quantity
2L55001	RL55	4	M5	25
2L55002	RL55	4	1/8	25
2L55007	RL55	6	M5	25
2L55008	RL55	6	1/8	25
2L55009	RL55	6	1/4	25
2L55010	RL55	8	1/8	25
2L55011	RL55	8	1/4	25
2L55012	RL55	8	3/8	25
2L55013	RL55	10	1/4	25
2L55014	RL55	10	3/8	25
2L55018	RL55	12	1/4	25
2L55016	RL55	12	3/8	25
2L55017	RL55	12	1/2	25

**LATERAL TEE, MALE, CYLINDRICAL, ROTARY (R38)**

Code	Ref.	Ø	Thread	Quantity
2L38002	RL38	4	1/8	50
2038005	R38	5	1/8	50
2L38008	RL38	6	1/8	50
2L38009	RL38	6	1/4	50
2L38010	RL38	8	1/8	50
2L38011	RL38	8	1/4	25
2L38013	RL38	10	1/4	25
2L38014	RL38	10	3/8	50
2038015	RL38	12	3/8	50
2038016	RL38	12	1/2	50

**DUAL ROD SINGLE ROTARY RINGS (R50)**

Code	Ref.	Ø	Thread	Quantity
2L50001	RL50	4	M5	25
2L50002	RL50	4	1/8	25
2033002	R33	5	1/8	25
2L50007	RL50	6	M5	25
2L50008	RL50	6	1/8	25
2L50009	RL50	6	1/4	25
2L50010	RL50	8	1/8	25
2L50011	RL50	8	1/4	25
2L50013	RL50	10	1/4	25

**TRIPLE ROD DUAL ROTARY RINGS (R53)**

Code	Ref.	Ø	Thread	Quantity
2L53002	RL53	4	1/8	20
2L53008	RL53	6	1/8	20
2L53009	RL53	6	1/4	10
2L53010	RL53	8	1/8	10
2L53011	RL53	8	1/4	10
2L53013	RL53	10	1/4	10

**DUAL ROD, MALE SINGLE SWIVEL RINGS (R56)**

Code	Ref.	Ø	Thread	Quantity
2L56001	RL56	4	M5	25
2L56002	RL56	4	1/8	25
2L56007	RL56	6	M5	25
2L56008	RL56	6	1/8	25
2L56009	RL56	6	1/4	25
2L56010	RL56	8	1/8	25
2L56011	RL56	8	1/4	25
2L56012	RL56	8	3/8	25
2L56013	RL56	10	1/4	25
2L56014	RL56	10	3/8	10
2L56016	RL56	12	3/8	10
2L56017	RL56	12	1/2	10

**ELBOW, MALE, CONICAL (R39C)**

Code	Ref.	Ø	Thread	Quantity
2L39C02	RL39/C	4	1/8	50
2L39C08	RL39/C	6	1/8	50
2L39C09	RL39/C	6	1/4	50
2039Z07	RL39/Z	6	12x1 conical	50
2039Z08	RL39/Z	6	12x1.25 conical	50
2L39C10	RL39/C	8	1/8	50
2L39C11	RL39/C	8	1/4	50
2L39C13	RL39/C	10	1/4	25

**DUAL ROD DUAL ROTARY RINGS (R51)**

Code	Ref.	Ø	Thread	Quantity
2L51001	RL51	4	M5	25
2L51002	RL51	4	1/8	25
2L51007	RL51	6	M5	25
2L51008	RL51	6	1/8	25
2L51009	RL51	6	1/4	25
2L51010	RL51	8	1/8	25
2L51011	RL51	8	1/4	25
2L51013	RL51	10	1/4	10

**MALE ROD, SINGLE SWIVEL RING (R54)**

Code	Ref.	Ø	Thread	Quantity
2L54001	RL54	4	M5	50
2L54002	RL54	4	1/8	50
2L54007	RL54	6	M5	50
2L54008	RL54	6	1/8	50
2L54009	RL54	6	1/4	50
2L54010	RL54	8	1/8	50
2L54011	RL54	8	1/4	50
2L54012	RL54	8	3/8	25
2L54013	RL54	10	1/4	50
2L54014	RL54	10	3/8	25
2L54018	RL54	12	1/4	25
2L54016	RL54	12	3/8	25
2L54017	RL54	12	1/2	25

**DUAL ROD, MALE DUAL SWIVEL RINGS (R57)**

Code	Ref.	Ø	Thread	Quantity
2L57001	RL57	4	M5	25
2L57002	RL57	4	1/8	25
2L57007	RL57	6	M5	25
2L57008	RL57	6	1/8	25
2L57009	RL57	6	1/4	25
2L57010	RL57	8	1/8	25
2L57011	RL57	8	1/4	25
2L57012	RL57	8	3/8	10
2L57013	RL57	10	1/4	10
2L57014	RL57	10	3/8	10
2L57016	RL57	12	3/8	10
2L57017	RL57	12	1/2	5



UNF  
NPT

## BRASS PUSH-IN FITTINGS FOR INCH TUBES AND UNF or NPT THREAD

### STRAIGHT, CYLINDRICAL, MALE (RU1)



Code	Ref.	Ø	F
2U01A02	RU1	1/8	10-32 UNF
2U01A03	RU1	1/8	1/8 NPT
2U01001	RU1	5/32	10-32 UNF
2U01002	RU1	5/32	1/8 NPT
2U01003	RU1	5/32	1/4 NPT
2U01000	RU1	1/4	10-32 UNF
2U01007	RU1	1/4	1/8 NPT
2U01008	RU1	1/4	1/4 NPT
2U01020	RU1	1/4	3/8 NPT
2U01009	RU1	5/16	1/8 NPT
2U01010	RU1	5/16	1/4 NPT
2U01011	RU1	5/16	3/8 NPT
2U01012	RU1	3/8	1/4 NPT
2U01013	RU1	3/8	3/8 NPT
2U01021	RU1	3/8	1/2 NPT
2U01014	RU1	1/2	3/8 NPT
2U01015	RU1	1/2	1/2 NPT

### STRAIGHT, FEMALE (RU2)



Code	Ref.	Ø	F
2U02A03	RU2	1/8	1/8 NPT
2U02001	RU2	5/32	1/8 NPT
2U02002	RU2	5/32	1/4 NPT
2U02005	RU2	1/4	1/8 NPT
2U02006	RU2	1/4	1/4 NPT
2U02007	RU2	5/16	1/8 NPT
2U02008	RU2	5/16	1/4 NPT

### STRAIGHT, INTERMEDIATE (RU3)



Code	Ref.	Ø
2003A01	R3	1/8
2L03001	RL3	5/32
2U03003	RU3	1/4
2L03004	RL3	5/16
2U03005	RU3	3/8
2U03006	RU3	1/2

### ELBOW, INTERMEDIATE (RU4)



Code	Ref.	Ø
2004A01	R4	1/8
2L04001	RL4	5/32
2U04003	RU4	1/4
2L04004	RL4	5/16
2U04005	RU4	3/8
2U04006	RU4	1/2

### TEE, INTERMEDIATE (RU5)



Code	Ref.	Ø
2005A01	R5	1/8
2L05001	RL5	5/32
2U05003	RU5	1/4
2L05004	RL5	5/16
2U05005	RU5	3/8
2U05006	RU5	1/2

### THREADED ADAPTER (RU6)



Code	Ref.	Ø	F
2U06A01	RU6	1/8	10-32 UNF
2U06A02	RU6	1/8	1/8 NPT
2U06001	RU6	5/32	10-32 UNF
2U06002	RU6	5/32	1/8 NPT
2U06003	RU6	5/32	1/4 NPT
2U06000	RU6	1/4	10-32 UNF
2U06007	RU6	1/4	1/8 NPT
2U06008	RU6	1/4	1/4 NPT
2U06020	RU6	1/4	3/8 NPT
2U06009	RU6	5/16	1/8 NPT
2U06010	RU6	5/16	1/4 NPT
2U06011	RU6	5/16	3/8 NPT
2U06012	RU6	3/8	1/4 NPT
2U06013	RU6	3/8	3/8 NPT
2U06022	RU6	3/8	1/2 NPT
2U06014	RU6	1/2	3/8 NPT
2U06015	RU6	1/2	1/2 NPT

### EXTENSION (RU7)



Code	Ref.	Ø
2007001	R7	5/32
2U07003	RU7	1/4
2L07004	RL7	5/16
2U07005	RU7	3/8
2U07006	RU7	1/2

### REDUCER (RU8)



Code	Ref.	Ø 1	Ø 2
2008A02	R8	5/32	1/8
2U08002	RU8	1/4	5/32
2L08004	RL8	5/16	5/32
2U08006	RU8	5/16	1/4
2U08007	RU8	3/8	1/4
2U08010	RU8	1/2	1/4
2U08011	RU8	1/2	5/16
2U08015	RU8	1/2	3/8

### PLUG (RU9)



Code	Ref.	Ø
2L10A01	RL9T	1/8
2L10001	RL9T	5/32
2U10003	RU9	1/4
2L10004	RL9T	5/16
2U10005	RU9	3/8
2U10006	RU9	1/2

### STRAIGHT, INTERMEDIATE, BULKMTAD (RU10)



Code	Ref.	Ø	F
2011A01	R10	1/8	M8x0.75
2L11001	RL10	5/32	M11x1
2U11003	RU10	1/4	M13x1
2L11004	RL10	5/16	M15x1
2U11005	RU10	3/8	M17x1
2U11006	RU10	1/2	M22x1

### ROD, MALE SINGLE ROTARY RING (RU15)



Code	Ref.	Ø	F
2U14104	RU15	1/8	10-32 UNF
2U14001	RU15	5/32	10-32 UNF
2U14002	RU15	5/32	1/8 NPT
2U14106	RU15	1/4	10-32 UNF
2U14005	RU15	1/4	1/8 NPT
2U14007	RU15	1/4	1/4 NPT
2U14006	RU15	5/16	1/8 NPT
2U14008	RU15	5/16	1/4 NPT
2U14013	RU15	5/16	3/8 NPT
2U14009	RU15	3/8	1/4 NPT
2U14014	RU15	3/8	3/8 NPT
2U14011	RU15	1/2	3/8 NPT
2U14012	RU15	1/2	1/2 NPT

### ROD, MALE DUAL ROTARY RING (RU16)



Code	Ref.	Ø	F
2U15001	RU16	5/32	10-32 UNF
2U15002	RU16	5/32	1/8 NPT
2U15106	RU16	1/4	10-32 UNF
2U15005	RU16	1/4	1/8 NPT
2U15007	RU16	1/4	1/4 NPT
2U15006	RU16	5/16	1/8 NPT
2U15008	RU16	5/16	1/4 NPT
2U15013	RU16	5/16	3/8 NPT
2U15009	RU16	3/8	1/4 NPT
2U15014	RU16	3/8	3/8 NPT
2U15011	RU16	1/2	3/8 NPT
2U15012	RU16	1/2	1/2 NPT

**ROTARY ELBOW, MALE, CYLINDRICAL (RU31)**

Code	Ref.	Ø	F
2U31001	RU31	5/32	10-32 UNF
2U31002	RU31	5/32	1/8 NPT
2U31003	RU31	5/32	1/4 NPT
2U31007	RU31	1/4	10-32 UNF
2U31008	RU31	1/4	1/8 NPT
2U31009	RU31	1/4	1/4 NPT
2U31010	RU31	5/16	1/8 NPT
2U31011	RU31	5/16	1/4 NPT
2U31012	RU31	5/16	3/8 NPT
2U31013	RU31	3/8	1/4 NPT
2U31014	RU31	3/8	3/8 NPT
2U31015	RU31	3/8	1/2 NPT
2U31017	RU31	1/2	3/8 NPT
2U31018	RU31	1/2	1/2 NPT

**CENTRAL TEE, MALE, CYLINDRICAL, ROTARY (RU32)**

Code	Ref.	Ø	F
2U32002	RU32	5/32	1/8 NPT
2U32003	RU32	5/32	1/4 NPT
2U32007	RU32	1/4	10-32 UNF
2U32008	RU32	1/4	1/8 NPT
2U32009	RU32	1/4	1/4 NPT
2U32010	RU32	5/16	1/8 NPT
2U32011	RU32	5/16	1/4 NPT
2U32012	RU32	5/16	3/8 NPT
2U32013	RU32	3/8	1/4 NPT
2U32014	RU32	3/8	3/8 NPT
2U32015	RU32	3/8	1/2 NPT
2U32017	RU32	1/2	3/8 NPT
2U32018	RU32	1/2	1/2 NPT

**MALE ROD, SINGLE SWIVEL RING (RU54)**

Code	Ref.	Ø	F
2U54001	RU54	5/32	10-32 UNF
2U54002	RU54	5/32	1/8 NPT
2U54007	RU54	1/4	10-32 UNF
2U54008	RU54	1/4	1/8 NPT
2U54009	RU54	1/4	1/4 NPT
2U54010	RU54	5/16	1/8 NPT
2U54011	RU54	5/16	1/4 NPT
2U54012	RU54	5/16	3/8 NPT
2U54013	RU54	3/8	1/4 NPT
2U54014	RU54	3/8	3/8 NPT
2U54016	RU54	1/2	3/8 NPT
2U54017	RU54	1/2	1/2 NPT

**MALE ROD, DUAL SWIVEL RING (RU55)**

Code	Ref.	Ø	F
2U55001	RU55	5/32	10-32 UNF
2U55002	RU55	5/32	1/8 NPT
2U55007	RU55	1/4	10-32 UNF
2U55008	RU55	1/4	1/8 NPT
2U55009	RU55	1/4	1/4 NPT
2U55010	RU55	5/16	1/8 NPT
2U55011	RU55	5/16	1/4 NPT
2U55012	RU55	5/16	3/8 NPT
2U55013	RU55	3/8	1/4 NPT
2U55014	RU55	3/8	3/8 NPT
2U55016	RU55	1/2	3/8 NPT
2U55017	RU55	1/2	1/2 NPT

**DUAL ROD, MALE SINGLE SWIVEL RINGS (RU56)**

Code	Ref.	Ø	F
2U56001	RU56	5/32	10-32 UNF
2U56002	RU56	5/32	1/8 NPT
2U56007	RU56	1/4	10-32 UNF
2U56008	RU56	1/4	1/8 NPT
2U56009	RU56	1/4	1/4 NP
2U56010	RU56	5/16	1/8 NPT
2U56011	RU56	5/16	1/4 NPT
2U56012	RU56	5/16	3/8 NPT
2U56013	RU56	3/8	1/4 NPT
2U56014	RU56	3/8	3/8 NPT
2U56016	RU56	1/2	3/8 NPT
2U56017	RU56	1/2	1/2 NPT

**DUAL ROD, MALE DUAL SWIVEL RINGS (RU57)**

Code	Ref.	Ø	F
2U57001	RU57	5/32	10-32 UNF
2U57002	RU57	5/32	1/8 NPT
2U57007	RU57	1/4	10-32 UNF
2U57008	RU57	1/4	1/8 NPT
2U57009	RU57	1/4	1/4 NPT
2U57010	RU57	5/16	1/8 NPT
2U57011	RU57	5/16	1/4 NPT
2U57012	RU57	5/16	3/8 NPT
2U57013	RU57	3/8	1/4 NPT
2U57014	RU57	3/8	3/8 NPT
2U57016	RU57	1/2	3/8 NPT
2U57017	RU57	1/2	1/2 NPT

**ADAPTORS AND PLUGS FOR G (BSPP) AND NPT THREAD**
**AU5/G - NPT FEMALE G (BSPP) MALE ADAPTORS**

Code	Ref.	F	F1
2105100U	AU5/G	M5	10-32 UNF
2105101U	AU5/G	G 1/8	1/8 NPT
2105103U	AU5/G	G 1/4	1/4 NPT
2105105U	AU5/G	G 3/8	3/8 NPT
2105107U	AU5/G	G 1/2	1/2 NPT

**AU5/N - NPT MALE G (BSPP) FEMALE ADAPTORS**

Code	Ref.	F	F1
2105200U	AU5/N	10-32 UNF	M5
2105201U	AU5/N	1/8 NPT	G 1/8
2105203U	AU5/N	1/4 NPT	G 1/4
2105205U	AU5/N	3/8 NPT	G 3/8
2105207U	AU5/N	1/2 NPT	G 1/2

**AU7 - PLUG MALE NPT**

Code	Ref.	F
2107000U	AU7	10-32 UNF
2107001U	AU7	1/8 NPT
2107002U	AU7	1/4 NPT
2107003U	AU7	3/8 NPT
2107004U	AU7	1/2 NPT



## TECHNOPOLYMER PUSH-IN FITTINGS FOR mm TUBES AND G (BSP) or METRIC THREAD

### STRAIGHT, INTERMEDIATE, TECHNOPOLYMER (R19)



Code	Ref.	Ø	Quantity
2019001	RL19	4	50
2019002	R19	5	50
2019003	RL19	6	50
2019004	RL19	8	50
2019005	RL19	10	50
2019006	RL19	12	25

### ELBOW, INTERMEDIATE, TECHNOPOLYMER (R21)



Code	Ref.	Ø	Quantity
2121001	RL21	4	50
2021002	R21	5	50
2121003	RL21	6	50
2121004	RL21	8	50
2021005	RL21	10	50
2021006	RL21	12	25

### Y TECHNOPOLYMER, THREADED INPUT (R23/M)



Code	Ref.	Ø	Thread	Quantity
2123401	RL23/M	4	M5	25
2123402	RL23/M	4	1/8	25
2123403	RL23/M	4	1/4	25
2123406	RL23/M	6	1/8	25
2123407	RL23/M	6	1/4	25
2123409	RL23/M	8	1/8	25
2123410	RL23/M	8	1/4	25
2123412	RL23/M	8	3/8	25
2123413	RL23/M	10	1/4	10
2123415	RL23/M	10	3/8	10
2123419	RL23/M	12	3/8	10
2123420	RL23/M	12	1/2	10

### SINGLE RING, TECHNOPOLYMER (R28)



Code	Ref.	Ø	Ø FOR:	Quantity
2012102	R28	4	1/8	50
2012104	R28	5	1/8	50
2012106	R28	6	1/8	50
2012107	R28	6	1/4	50
2012108	R28	8	1/8	50
2012109	R28	8	1/4	50
2012110	R28	8	3/8	50
2012111	R28	10	1/4	50
2012112	R28	10	3/8	50
2012113	R28	12	1/4	50
2012114	R28	12	3/8	50
2012115	R28	12	1/2	50

For the rods series D

### MALE ROD, SINGLE ROTARY RING, TECHNOPOLYMER (R20)



Code	Ref.	Ø	Thread	Quantity
2020001	RL20	4	M5	50
2020002	RL20	4	1/8	50
2020003	R20	5	M5	50
2020004	R20	5	1/8	50
2020016	RL20	6	M5	50
2020005	RL20	6	1/8	50
2020007	RL20	6	1/4	50
2020006	RL20	8	1/8	50
2020008	RL20	8	1/4	50
2020009	RL20	10	1/4	50
2120017	RL20	10	3/8	25
2020010	RL20	12	1/4	25
2020011	RL20	12	3/8	20
2020012	RL20	12	1/2	25

### INTERMEDIATE TEE, TECHNOPOLYMER (R22)



Code	Ref.	Ø	Quantity
2122001	RL22	4	50
2022002	R22	5	50
2122003	RL22	6	50
2122004	RL22	8	50
2022005	RL22	10	25
2022006	RL22	12	20

### Y BRANCH WITH ADAPTER, TECHNOPOLYMER (R24)



Code	Ref.	Ø1	Ø2 X 2	Quantity
2024001	RL24	4	4	50
2024003	RL24	6	6	50
2124004	RL24	8	8	50
2124005	RL24	10	10	25
2124006	RL24	12	12	25
2124301	RL24	6	4	50
2124303	RL24	8	6	50
2124306	RL24	10	8	25
2124309	RL24	12	10	25

### DUAL RING, TECHNOPOLYMER (R29)



Code	Ref.	Ø	Ø FOR:	Quantity
2013102	R29	4	1/8	50
2013104	R29	5	1/8	50
2013106	R29	6	1/8	50
2013107	R29	6	1/4	50
2013108	R29	8	1/8	50
2013109	R29	8	1/4	50
2013110	R29	8	3/8	50
2013111	R29	10	1/4	50
2013112	R29	10	3/8	50
2013113	R29	12	1/4	50
2013114	R29	12	3/8	50
2013115	R29	12	1/2	50

For the rods series D

### MALE ROD, DUAL ROTARY RING, TECHNOPOLYMER (R20/A)



Code	Ref.	Ø	Thread	Quantity
2020A01	R20/A	4	M5	50
2020A02	R20/A	4	1/8	50
2020A03	R20/A	5	M5	50
2020A04	R20/A	5	1/8	50
2020A05	R20/A	6	1/8	50
2020A07	R20/A	6	1/4	50
2020A06	R20/A	8	1/8	50
2020A08	R20/A	8	1/4	25
2020A09	R20/A	10	1/4	25
2020A10	R20/A	12	1/4	25
2020A11	R20/A	12	3/8	20
2020A12	R20/A	12	1/2	25

### WYE (R23)



Code	Ref.	Ø1	Ø2 X 2	Quantity
2023001	RL23	4	4	50
2023002	R23	5	5	50
2023003	RL23	6	6	50
2023004	RL23	8	8	50
2123005	RL23	10	10	25
2123006	RL23	12	12	25
2123301	RL23	6	4	50
2123303	RL23	8	6	50
2123306	RL23	10	8	25
2123309	RL23	12	10	25

### TECHNOPOLYMER PARALLEL Y, THREADED INPUT (R25)



Code	Ref.	Ø	Thread	Quantity
2125001	RL25	4	M5	10
2125002	RL25	4	M7	10
2125003	RL25	4	1/8	10
2125004	RL25	6	1/8	10
2125005	RL25	6	1/4	10
2125008	RL25	8	1/4	10
2125009	RL25	8	3/8	10

### ROTARY ELBOW, MALE, TECHNOPOLYMER (R34)



Code	Ref.	Ø	Thread	Quantity
2134001	RL34	4	M5	50
2134020	RL34	4	M7	50
2134002	RL34	4	1/8	50
2134003	RL34	4	1/4	50
2134006	RL34	6	M5	50
2134021	RL34	6	M7	50
2134007	RL34	6	1/8	50
2134008	RL34	6	1/4	50
2134009	RL34	8	1/8	50
2134010	RL34	8	1/4	50
2134011	RL34	8	3/8	50
2134013	RL34	10	1/4	50
2134014	RL34	10	3/8	25
2134016	RL34	12	3/8	25
2134017	RL34	12	1/2	25

**ELBOW, FEMALE, ROTARY, TECHNOPOLYMER (R34/F)**

Code	Ref.	Ø	Thread	Quantity
2L34F01	RL34/F	4	M5	50
2L34F05	RL34/F	4	1/8	50
2L34F06	RL34/F	6	M5	50
2L34F07	RL34/F	6	1/8	50
2L34F08	RL34/F	6	1/4	50
2L34F09	RL34/F	8	1/8	50
2L34F10	RL34/F	8	1/4	50
2L34F13	RL34/F	10	1/4	25
2L34F14	RL34/F	10	3/8	25
2L34F16	RL34/F	12	3/8	25
2L34F17	RL34/F	12	1/2	25

**ROTARY ELBOW, MALE, EXTENDED, TECHNOPOLYMER (R36)**

Code	Ref.	Ø	Thread	Quantity
2L36001	RL36	4	M5	50
2L36020	RL36	4	M7	50
2L36002	RL36	4	1/8	50
2L36006	RL36	6	M5	50
2L36021	RL36	6	M7	50
2L36007	RL36	6	1/8	50
2L36008	RL36	6	1/4	50
2L36009	RL36	8	1/8	50
2L36010	RL36	8	1/4	50
2L36012	RL36	10	1/4	25

**DUAL Y BRANCH TECHNOPOLYMER, THREADED INPUT (R43)**

Code	Ref.	Ø1	Thread	Quantity
2L43001	RL43	4	M5	10
2L43002	RL43	4	1/8	10
2L43003	RL43	4	1/4	10
2L43008	RL43	6	1/8	10
2L43009	RL43	6	1/4	10

**PLUG-IN ELBOWS (R46)**

Code	Ref.	Ø	Quantity
2L46001	RL46	4	50
2L46002	RL46	6	50
2L46003	RL46	8	50
2L46004	RL46	10	25

**CENTRAL TEE, MALE, TECHNOPOLYMER (R35)**

Code	Ref.	Ø	Thread	Quantity
2L35001	RL35	4	M5	50
2L35020	RL35	4	M7	50
2L35002	RL35	4	1/8	50
2L35003	RL35	4	1/4	50
2L35006	RL35	6	M5	50
2L35007	RL35	6	1/8	50
2L35008	RL35	6	1/4	50
2L35009	RL35	8	1/8	50
2L35010	RL35	8	1/4	50
2L35011	RL35	8	3/8	50
2L35013	RL35	10	1/4	25
2L35014	RL35	10	3/8	25
2L35016	RL35	12	3/8	25
2L35017	RL35	12	1/2	20

**CENTRAL TEE, MALE, ROTARY, EXTENDED, TECHNOPOLYMER (R37)**

Code	Ref.	Ø	Thread	Quantity
2L37001	RL37	4	M5	50
2L37020	RL37	4	M7	50
2L37002	RL37	4	1/8	50
2L37006	RL37	6	M5	50
2L37007	RL37	6	1/8	50
2L37008	RL37	6	1/4	50
2L37009	RL37	8	1/8	50
2L37010	RL37	8	1/4	50
2L37012	RL37	10	1/4	25

**MULTIPLE MANIFOLD, TECHNOPOLYMER (R44)**

Code	Ref.	Ø1 X 2	Ø2 X 3	Quantity
2L44001	RL44	6	4	10
2L44003	RL44	8	6	10

**EXTENDED PLUG-IN ELBOWS (R47)**

Code	Ref.	Ø	Quantity
2L47001	RL47	4	50
2L47002	RL47	6	50
2L47003	RL47	8	50

**CENTRAL TEE, FEMALE, ROTARY, TECHNOPOLYMER (R35/F)**

Code	Ref.	Ø	Thread	Quantity
2L35F01	RL35/F	4	M5	50
2L35F06	RL35/F	6	M5	50
2L35F07	RL35/F	6	1/8	50
2L35F08	RL35/F	6	1/4	25
2L35F09	RL35/F	8	1/8	50
2L35F10	RL35/F	8	1/4	25
2L35F13	RL35/F	10	1/4	25
2L35F14	RL35/F	10	3/8	25
2L35F16	RL35/F	12	3/8	25
2L35F17	RL35/F	12	1/2	20

**DUAL Y BRANCH TECHNOPOLYMER (R42)**

Code	Ref.	Ø1 X 4	Ø2	Quantity
2L42001	RL42	4	4	10
2L42002	RL42	4	6	10
2L42004	RL42	6	6	10
2L42005	RL42	6	8	10

**MULTIPLE MANIFOLD, INPUT, THREADED, TECHNOPOLYMER (R45)**

Code	Ref.	Thread	Ø1	Ø2 X 3	Quantity
2L45001	RL45	1/8	6	4	10
2L45002	RL45	1/4	6	4	10
2L45007	RL45	1/8	8	6	10
2L45008	RL45	1/4	8	6	10
2L45009	RL45	3/8	8	6	10

**DOUBLE ELBOW (R48)**

Code	Ref.	Ø	Quantity
2L48001	RL48	4	10
2L48002	RL48	6	10
2L48003	RL48	8	10
2L48004	RL48	10	10

**DOUBLE LATERAL ELBOW (R49)**

Code	Ref.	Ø	Quantity
2L49001	RL49	4	10
2L49003	RL49	6	10
2L49004	RL49	8	10
2L49005	RL49	10	10
2L49006	RL49	12	10

## CARTRIDGES AND ACCESSORIES

### BRASS CARTRIDGE WITH THREAD (R26)



Code	Ref.	Ø	Brace of serration on centers in plastic material [Nm]	Brace of serration on metallic centers [Nm]	Quantity
<b>SERIES R</b>					
2026A02	R26	3	0.6	0.8	50
2026A01	R26	3.17 ▲	0.6	0.8	50
2026001	R26	4 ▲	0.8	1	50
2026002	R26	5	0.8	1.5	50
2026003	R26	6	0.8	1.2	50
2026004	R26	8 ▲	1	1.8	50
2026005	R26	10	0.8	2	50
2026006	R26	12	0.8	2	50

▲ Ø 3.17 = Ø 1/8"; Ø 4 = Ø 5/32"; Ø 8 = Ø 5/16"

### MALE FOR CARTRIDGE SLOT R26



Code	Ref.
2025020	MA R26 3-3.17
2025021	MA R26 4
2025022	MA R26 5
2025023	MA R26 6
2025024	MA R26 8
2025025	MA R26 10
2025026	MA R26 12

### TOOL FOR SLOT R26



Code	Ref.
2025010	UT.SE. R26 3-3.17
2025011	UT.SE. R26 4
2025012	UT.SE. R26 5
2025013	UT.SE. R26 6
2025014	UT.SE. R26 8
2025015	UT.SE. R26 10
2025016	UT.SE. R26 12

### R41 - CARTRIDGE KEY R26



Code	Ref.	Ø
2041001	R41	4
2041002	R41	5
2041003	R41	6
2041004	R41	8
2041005	R41	10
2041006	R41	12

### BRASS COMPRESSION CARTRIDGE (R27)



Code	Ref.	Ø	Quantity
<b>SERIES R</b>			
2027001	R27	4 ▲	50
2027002	R27	5	50
2027003	R27	6	50
2027004	R27	8 ▲	50
2027005	R27	10	50
2027006	R27	12	50

▲ Ø 4 = Ø 5/32"; Ø 8 = Ø 5/16"

### TOOL FOR SLOT R27



Code	Ref.
<b>FOR ALUMINIUM</b>	
2027021	UT.SE. R27 AL. 4
2027022	UT.SE. R27 AL. 5
2027023	UT.SE. R27 AL. 6
2027024	UT.SE. R27 AL. 8
2027025	UT.SE. R27 AL. 10
2027026	UT.SE. R27 AL. 12

Code	Ref.
<b>FOR TECHNOPOLYMER</b>	
2027011	UT.SE. R27 P. 4
2027012	UT.SE. R27 P. 5
2027013	UT.SE. R27 P. 6
2027014	UT.SE. R27 P. 8
2027015	UT.SE. R27 P. 10
2027016	UT.SE. R27 P. 12

### R17 - DISASSEMBLY KEY

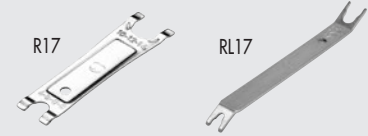

Code	Ref.	Ø Tube	Quantity
2L17001	RL17	from 3 to 10	50
2017001	R17	from 4 to 14	50

# SERIES F-E / SERIES F-NSF PUSH-IN FITTINGS FOR USE IN THE FOOD INDUSTRY



TECHNICAL FEATURES	SERIES F-E	SERIES F-NSF
Threaded port	M5 - G1/8" - G1/4" - G3/8" - G1/2"	
Pipe diameter	mm Ø 4 - Ø 6 - Ø 8 - Ø 10	
Temperature range	°C - 20 to + 150 °F - 4 to 302	
Pressure range	- 0.99 bar - 16 bar / - 0.099 MPa - 1.6 MPa	
Recommended pipe	Rilsan PA 11 - Nylon 6 - Polyamide 12 - Polypropylene	PTFE
Certifications		 NSF/ANSI 169

## STRAIGHT, CYLINDRICAL, MALE R1 F



Series F-E		Series F-NSF		Ø	Thread	Quantity
Code	Ref.	Code	Ref.			
2F01001	R1 F-E	2F01051	R1 F-NSF	4	M5	50
2F01002	R1 F-E	2F01052	R1 F-NSF	4	1/8	50
2F01003	R1 F-E	2F01053	R1 F-NSF	4	1/4	50
2F01000	R1 F-E	2F01050	R1 F-NSF	6	M5	50
2F01007	R1 F-E	2F01057	R1 F-NSF	6	1/8	50
2F01008	R1 F-E	2F01058	R1 F-NSF	6	1/4	50
2F01009	R1 F-E	2F01059	R1 F-NSF	8	1/8	50
2F01010	R1 F-E	2F01060	R1 F-NSF	8	1/4	50
2F01011	R1 F-E	2F01061	R1 F-NSF	8	3/8	50
2F01012	R1 F-E	2F01062	R1 F-NSF	10	1/4	50
2F01013	R1 F-E	2F01063	R1 F-NSF	10	3/8	50
2F01022	R1 F-E	2F01072	R1 F-NSF	10	1/2	50

## STRAIGHT, INTERMEDIATE R3 F



Series F-E		Series F-NSF		Ø	Thread	Quantity
Code	Ref.	Code	Ref.			
2F03001	R3 F-E	2F03051	R3 F-NSF	4	M13X1	50
2F03003	R3 F-E	2F03053	R3 F-NSF	6	M15X1	50
2F03004	R3 F-E	2F03054	R3 F-NSF	8	M17X1	50
2F03005	R3 F-E	2F03055	R3 F-NSF	10	M20X1	50

## THREADED ADAPTER R6 F



Series F-E		Series F-NSF		Ø	Thread	Quantity
Code	Ref.	Code	Ref.			
2F06001	R6 F-E	2F06051	R6 F-NSF	4	M5	50
2F06002	R6 F-E	2F06052	R6 F-NSF	4	1/8	50
2F06003	R6 F-E	2F06053	R6 F-NSF	4	1/4	50
2F06000	R6 F-E	2F06050	R6 F-NSF	6	M5	50
2F06007	R6 F-E	2F06057	R6 F-NSF	6	1/8	50
2F06008	R6 F-E	2F06058	R6 F-NSF	6	1/4	50
2F06009	R6 F-E	2F06059	R6 F-NSF	8	1/8	50
2F06010	R6 F-E	2F06060	R6 F-NSF	8	1/4	50
2F06011	R6 F-E	2F06061	R6 F-NSF	8	3/8	50
2F06012	R6 F-E	2F06062	R6 F-NSF	10	1/4	50
2F06013	R6 F-E	2F06063	R6 F-NSF	10	3/8	50

## STRAIGHT, CONICAL, MALE R1C F



Series F-E		Series F-NSF		Ø	Thread	Quantity
Code	Ref.	Code	Ref.			
2F01C02	R1C F-E	2F01C52	R1C F-NSF	4	1/8	50
2F01C07	R1C F-E	2F01C57	R1C F-NSF	6	1/8	50
2F01C08	R1C F-E	2F01C58	R1C F-NSF	6	1/4	50
2F01C09	R1C F-E	2F01C59	R1C F-NSF	8	1/8	50
2F01C10	R1C F-E	2F01C60	R1C F-NSF	8	1/4	50
2F01C11	R1C F-E	2F01C61	R1C F-NSF	8	3/8	50
2F01C13	R1C F-E	2F01C63	R1C F-NSF	10	1/4	50
2F01C14	R1C F-E	2F01C64	R1C F-NSF	10	3/8	25

## ELBOW, INTERMEDIATE R4 F



Series F-E		Series F-NSF		Ø	Quantity
Code	Ref.	Code	Ref.		
2F04001	R4 F-E	2F04051	R4 F-NSF	4	50
2F04003	R4 F-E	2F04053	R4 F-NSF	6	50
2F04004	R4 F-E	2F04054	R4 F-NSF	8	50
2F04005	R4 F-E	2F04055	R4 F-NSF	10	50

## STRAIGHT, INTERMEDIATE, BULKHEAD UNIONS R10 F



Series F-E		Series F-NSF		Ø	Thread	Quantity
Code	Ref.	Code	Ref.			
2F11001	R10 F-E	2F11051	R10 F-NSF	4	M13x1	50
2F11003	R10 F-E	2F11053	R10 F-NSF	6	M15x1	50
2F11004	R10 F-E	2F11054	R10 F-NSF	8	M17x1	50
2F11005	R10 F-E	2F11055	R10 F-NSF	10	M20x1	25

## STRAIGHT, FEMALE R2 F



Series F-E		Series F-NSF		Ø	Thread	Quantity
Code	Ref.	Code	Ref.			
2F02001	R2 F-E	2F02051	R2 F-NSF	4	1/8	50
2F02005	R2 F-E	2F02055	R2 F-NSF	6	1/8	50
2F02006	R2 F-E	2F02056	R2 F-NSF	6	1/4	50
2F02007	R2 F-E	2F02057	R2 F-NSF	8	1/8	50
2F02008	R2 F-E	2F02058	R2 F-NSF	8	1/4	50
2F02011	R2 F-E	2F02061	R2 F-NSF	10	1/4	50

## TEE, INTERMEDIATE R5 F



Series F-E		Series F-NSF		Ø	Quantity
Code	Ref.	Code	Ref.		
2F05001	R5 F-E	2F05051	R5 F-NSF	4	50
2F05003	R5 F-E	2F05053	R5 F-NSF	6	50
2F05004	R5 F-E	2F05054	R5 F-NSF	8	50
2F05005	R5 F-E	2F05055	R5 F-NSF	10	20

## ROTARY ELBOW, MALE, CYLINDRICAL R31 F



Series F-E		Series F-NSF		Ø	Thread	Quantity
Code	Ref.	Code	Ref.			
2F31001	R31 F-E	2F31051	R31 F-NSF	4	M5	50
2F31002	R31 F-E	2F31052	R31 F-NSF	4	1/8	50
2F31003	R31 F-E	2F31053	R31 F-NSF	4	1/4	50
2F31007	R31 F-E	2F31057	R31 F-NSF	6	M5	50
2F31008	R31 F-E	2F31058	R31 F-NSF	6	1/8	50
2F31009	R31 F-E	2F31059	R31 F-NSF	6	1/4	50
2F31010	R31 F-E	2F31060	R31 F-NSF	8	1/8	50
2F31011	R31 F-E	2F31061	R31 F-NSF	8	1/4	50
2F31012	R31 F-E	2F31062	R31 F-NSF	8	3/8	50
2F31013	R31 F-E	2F31063	R31 F-NSF	10	1/4	50
2F31014	R31 F-E	2F31064	R31 F-NSF	10	3/8	25
2F31015	R31 F-E	2F31065	R31 F-NSF	10	1/2	25



**ROTARY ELBOW, MALE, CONICAL R31C F**



Series F-E		Series F-NSF		Ø	Thread	Quantity
Code	Ref.	Code	Ref.			
2F31C02	R31C F-E	2F31C52	R31C F-NSF	4	1/8	50
2F31C03	R31C F-E	2F31C53	R31C F-NSF	4	1/4	50
2F31C08	R31C F-E	2F31C58	R31C F-NSF	6	1/8	50
2F31C09	R31C F-E	2F31C59	R31C F-NSF	6	1/4	50
2F31C10	R31C F-E	2F31C60	R31C F-NSF	8	1/8	50
2F31C11	R31C F-E	2F31C61	R31C F-NSF	8	1/4	50
2F31C12	R31C F-E	2F31C62	R31C F-NSF	8	3/8	50
2F31C13	R31C F-E	2F31C63	R31C F-NSF	10	1/4	25
2F31C14	R31C F-E	2F31C64	R31C F-NSF	10	3/8	25

**NOTE**

**CENTRAL TEE, MALE, CYLINDRICAL, ROTARY R32 F**



Series F-E		Series F-NSF		Ø	Thread	Quantity
Code	Ref.	Code	Ref.			
2F32002	R32 F-E	2F32052	R32 F-NSF	4	1/8	50
2F32008	R32 F-E	2F32058	R32 F-NSF	6	1/8	50
2F32009	R32 F-E	2F32059	R32 F-NSF	6	1/4	50
2F32010	R32 F-E	2F32060	R32 F-NSF	8	1/8	50
2F32011	R32 F-E	2F32061	R32 F-NSF	8	1/4	50
2F32012	R32 F-E	2F32062	R32 F-NSF	8	3/8	50
2F32013	R32 F-E	2F32063	R32 F-NSF	10	1/4	25
2F32014	R32 F-E	2F32064	R32 F-NSF	10	3/8	25

**LATERAL TEE, MALE, CYLINDRICAL, ROTARY R38 F**



Series F-E		Series F-NSF		Ø	Thread	Quantity
Code	Ref.	Code	Ref.			
2F38002	R38 F-E	2F38052	R38 F-NSF	4	1/8	50
2F38008	R38 F-E	2F38058	R38 F-NSF	6	1/8	50
2F38009	R38 F-E	2F38059	R38 F-NSF	6	1/4	50
2F38010	R38 F-E	2F38060	R38 F-NSF	8	1/8	50
2F38011	R38 F-E	2F38061	R38 F-NSF	8	1/4	50
2F38013	R38 F-E	2F38063	R38 F-NSF	10	1/4	25
2F38014	R38 F-E	2F38064	R38 F-NSF	10	3/8	25

**ELBOW, MALE, CONICAL R39 F**



Series F-E		Series F-NSF		Ø	Thread	Quantity
Code	Ref.	Code	Ref.			
2F39C02	R39 F-E	2F39C52	R39 F-NSF	4	1/8	50
2F39C08	R39 F-E	2F39C58	R39 F-NSF	6	1/8	50
2F39C09	R39 F-E	2F39C59	R39 F-NSF	6	1/4	50
2F39C10	R39 F-E	2F39C60	R39 F-NSF	8	1/8	50
2F39C11	R39 F-E	2F39C61	R39 F-NSF	8	1/4	50
2F39C12	R39 F-E	2F39C62	R39 F-NSF	8	3/8	50
2F39C13	R39 F-E	2F39C63	R39 F-NSF	10	1/4	25

## STANDARD FITTING SERIES A

### NIPPLE, PARALLEL (A1)



Code	Ref.	Thread 1	Thread 2	Quantity
2101A00	A1	M5	M5	100
2101000	A1	M5	1/8	100
2101001	A1	1/8	1/8	100
2101002	A1	1/8	1/4	100
2101003	A1	1/8	3/8	50
2101004	A1	1/4	1/4	100
2101005	A1	1/4	3/8	50
2101006	A1	1/4	1/2	50
2101007	A1	3/8	3/8	50
2101008	A1	3/8	1/2	50
2101009	A1	1/2	1/2	50
2101010	A1	1/2	3/4	20
2101011	A1	3/4	3/4	25

Washer D11 can be used

### REDUCER, CONICAL (A4)



Code	Ref.	Thread 1	Thread 2	Quantity
2104001	A4	1/4	1/8	100
2104002	A4	3/8	1/8	100
2104003	A4	3/8	1/4	100
2104004	A4	1/2	1/4	50
2104005	A4	1/2	3/8	50
2104006	A4	3/4	1/2	50

### REDUCER, PARALLEL (A5/Z)



Code	Ref.	Thread 1	Thread 2	Quantity
2152001	A5/Z	M5	1/8	100
2152002	A5/Z	1/8	1/8	100
2152003	A5/Z	1/8	1/4	100
2152004	A5/Z	1/4	1/4	100
2152005	A5/Z	1/4	3/8	50
2152006	A5/Z	3/8	3/8	25
2152007	A5/Z	3/8	1/2	50
2152008	A5/Z	1/2	1/2	50

Washer D11 can be used

### NUB (A8)



Code	Ref.	Thread	Quantity
2108001	A8	1/8	100
2108002	A8	1/4	100
2108003	A8	3/8	50
2108004	A8	1/2	50

### NIPPLE, CONICAL (A2)



Code	Ref.	Thread 1	Thread 2	Quantity
2102001	A2	1/8	1/8	100
2102002	A2	1/8	1/4	100
2102003	A2	1/8	3/8	50
2102004	A2	1/4	1/4	100
2102005	A2	1/4	3/8	50
2102006	A2	1/4	1/2	25
2102007	A2	3/8	3/8	50
2102008	A2	3/8	1/2	50
2102009	A2	1/2	1/2	50
2102010	A2	1/2	3/4	25
2102011	A2	3/4	3/4	25

### REDUCER, PARALLEL (A4/Z)



Code	Ref.	Thread 1	Thread 2	Quantity
2151000	A4/Z	1/8	M5	100
2151001	A4/Z	1/4	1/8	100
2151002	A4/Z	3/8	1/8	100
2151003	A4/Z	3/8	1/4	100
2151004	A4/Z	1/2	1/4	50
2151005	A4/Z	1/2	3/8	50

Washer D11 can be used

### REDUCER A6



Code	Ref.	Thread 1	Thread 2	Quantity
2106001	A6	1/8	1/4	50
2106002	A6	1/8	3/8	50
2106003	A6	1/4	3/8	25
2106004	A6	1/4	1/2	50
2106005	A6	3/8	1/2	50

### ELBOW, FEMALE (A9)



Code	Ref.	Thread	Quantity
2109001	A9	1/8	50
2109002	A9	1/4	50
2109003	A9	3/8	20
2109004	A9	1/2	20

### SLEEVE (A3)



Code	Ref.	Thread	Quantity
2103000	A3	M5	50
2103001	A3	1/8	100
2103002	A3	1/4	50
2103003	A3	3/8	25
2103004	A3	1/2	20

### REDUCER, CONICAL (A5)



Code	Ref.	Thread 1	Thread 2	Quantity
2105001	A5	1/8	1/8	100
2105002	A5	1/8	1/4	100
2105003	A5	1/4	1/4	50
2105004	A5	1/4	3/8	25
2105005	A5	3/8	3/8	25
2105006	A5	3/8	1/2	50
2105007	A5	1/2	1/2	25

### PLUG WITH EXAGON EMBEDDED (A7)



Code	Ref.	Thread	Quantity
2107000	A7	M5	100
2107005	A7	M7	100
2107MO1*	A7	1/8	100
2107001	A7	1/8	100
2107002	A7	1/4	50
2107003	A7	3/8	50
2107004	A7	1/2	100

\* Miniaturized version

### ELBOW, MALE-FEMALE (A10)



Code	Ref.	Thread	Quantity
2110001	A10	1/8	100
2110002	A10	1/4	50
2110003	A10	3/8	25
2110004	A10	1/2	25

**TEE, FEMALE (A11)**

Code	Ref.	Thread	Quantity
2111001	A11	1/8	50
2111002	A11	1/4	20
2111003	A11	3/8	20
2111004	A11	1/2	10

**ELBOW, MALE (A15)**

Code	Ref.	Thread	Quantity
2115001	A15	1/8	100
2115002	A15	1/4	100
2115003	A15	3/8	25
2115004	A15	1/2	25

**HOSE ADAPTER, PARALLEL (A19)**

Code	Ref.	Ø	Thread	Quantity
2119001	A19	7	1/8	100
2119002	A19	7	1/4	100
2119003	A19	8	1/8	100
2119004	A19	9	1/8	50
2119005	A19	9	1/4	50
2119006	A19	9	3/8	100
2119007	A19	12	1/4	50
2119008	A19	12	3/8	50
2119009	A19	12	1/2	50
2119010	A19	17	3/8	25
2119011	A19	17	1/2	50

**Y, MALE 90° (A24)**

Code	Ref.	Thread	Quantity
2124001	A24	1/8	50
2124002	A24	1/4	50
2124003	A24	3/8	25
2124004	A24	1/2	10

**TEE, CENTRAL MALE (A12)**

Code	Ref.	Thread	Quantity
2112001	A12	1/8	100
2112002	A12	1/4	20
2112003	A12	3/8	25
2112004	A12	1/2	10

**TEE, MALE (A16)**

Code	Ref.	Thread	Quantity
2116001	A16	1/8	100
2116002	A16	1/4	50
2116003	A16	3/8	20
2116004	A16	1/2	10

**MALE-FEMALE EQUAL CROSS (A20)**

Code	Ref.	Thread	Quantity
2120001	A20	1/8	50
2120002	A20	1/4	25

**EXTENSION (A25)**

Code	Ref.	Thread	Quantity
2150003	A25	1/8	50
2150004	A25	1/8	50
2150005	A25	1/8	50
2150006	A25	1/4	50
2150007	A25	1/4	50

**TEE, LATERAL MALE (A13)**

Code	Ref.	Thread	Quantity
2113001	A13	1/8	100
2113002	A13	1/4	20
2113003	A13	3/8	25
2113004	A13	1/2	10

**TEE, CENTRAL FEMALE (A17)**

Code	Ref.	Thread	Quantity
2117001	A17	1/4	50
2117002	A17	1/8	50
2117003	A17	3/8	20
2117004	A17	1/2	10

**TEE CROSS (A21)**

Code	Ref.	Thread	Quantity
2121001	A21	1/8	25
2121002	A21	1/4	25
2121003	A21	3/8	10
2121004	A21	1/2	10

Maximum operating conditions for the A21s are different from other A-series fittings, namely max P13 bar, max T 50°C

**EQUAL FEMALE CROSS (A14)**

Code	Ref.	Thread	Quantity
2114001	A14	1/8	50
2114002	A14	1/4	25
2114003	A14	3/8	10

**TEE, LATERAL FEMALE (A18)**

Code	Ref.	Thread	Quantity
2118000	A18	1/8	100
2118001	A18	1/4	50
2118002	A18	3/8	20
2118003	A18	1/2	10

**Y, FEMALE 90° (A23)**

Code	Ref.	Thread	Quantity
2123001	A23	1/8	50
2123002	A23	1/4	50
2123003	A23	3/8	25
2123004	A23	1/2	20

## COMPRESSION FITTINGS SERIES B

STRAIGHT, MALE CONICAL (B1)



Code	Ref.	Ø	Thread	Quantity
2201001	B1	4/2	1/8	100
2201002	B1	6/4	1/8	100
2201003	B1	6/4	1/4	100
2201004	B1	8/6	1/8	100
2201005	B1	8/6	1/4	50
2201006	B1	8/6	3/8	100
2201007	B1	10/8	1/4	50
2201008	B1	10/8	3/8	50
2201009	B1	10/8	1/2	25
2201010	B1	12/10	3/8	50
2201011	B1	12/10	1/2	20
2201012	B1	15/12	1/2	25

BULKHEAD CONNECTOR (B4)



Code	Ref.	Ø	Quantity
2204001	B4	6/4	50
2204002	B4	8/6	50
2204003	B4	10/8	25
2204004	B4	12/10	25
2204005	B4	15/12	10

TEE, CENTRAL MALE (B7)



Code	Ref.	Ø	Thread	Quantity
2207001	B7	4/2	1/8	100
2207002	B7	6/4	1/8	100
2207003	B7	6/4	1/4	50
2207004	B7	8/6	1/8	50
2207005	B7	8/6	1/4	50
2207006	B7	8/6	3/8	20
2207007	B7	10/8	1/4	25
2207008	B7	10/8	3/8	25
2207010	B7	12/10	3/8	10
2207011	B7	12/10	1/2	10
2207012	B7	15/12	1/2	10

NUT (B10)



Code	Ref.	Ø	Quantity
2210001	B10	4/2	100
2210002	B10	6/4	100
2210003	B10	8/6	100
2210004	B10	10/8	50
2210005	B10	12/10	50
2210006	B10	15/12	25

STRAIGHT, FEMALE (B2)



Code	Ref.	Ø	Thread	Quantity
2202001	B2	6/4	1/8	100
2202002	B2	6/4	1/4	100
2202003	B2	8/6	1/8	50
2202004	B2	8/6	1/4	100
2202005	B2	8/6	3/8	50
2202006	B2	10/8	1/4	25
2202007	B2	10/8	3/8	25

ELBOW, MALE (B5)



Code	Ref.	Ø	Thread	Quantity
2205001	B5	4/2	1/8	100
2205002	B5	6/4	1/8	100
2205003	B5	6/4	1/4	50
2205004	B5	8/6	1/8	50
2205005	B5	8/6	1/4	100
2205006	B5	8/6	3/8	50
2205007	B5	10/8	1/4	50
2205008	B5	10/8	3/8	50
2205009	B5	10/8	1/2	25
2205010	B5	12/10	3/8	25
2205011	B5	12/10	1/2	25
2205012	B5	15/12	1/2	10

TEE, LATERAL MALE (B8)



Code	Ref.	Ø	Thread	Quantity
2208000	B8	4/2	1/8	100
2208001	B8	6/4	1/8	100
2208002	B8	6/4	1/4	50
2208003	B8	8/6	1/8	50
2208004	B8	8/6	1/4	50
2208005	B8	8/6	3/8	25
2208006	B8	10/8	1/4	25
2208007	B8	10/8	3/8	25
2208009	B8	12/10	3/8	10
2208010	B8	12/10	1/2	10
2208011	B8	15/12	1/2	10

OLIVE (B11)



Code	Ref.	Ø	Quantity
2211001	B11	4/2	100
2211002	B11	6/4	100
2211003	B11	8/6	100
2211004	B11	10/8	100
2211005	B11	12/10	100
2211006	B11	15/12	100

STRAIGHT, CONNECTOR (B3)



Code	Ref.	Ø	Quantity
2203001	B3	4/2	50
2203002	B3	6/4	50
2203003	B3	8/6	50
2203004	B3	10/8	50
2203005	B3	12/10	25
2203006	B3	15/12	20

ELBOW, FEMALE (B6)



Code	Ref.	Ø	Quantity
2206001	B6	4/2	100
2206002	B6	6/4	50
2206003	B6	8/6	50
2206004	B6	10/8	25
2206005	B6	12/10	25
2206006	B6	15/12	10

TEE, MALE (B9)



Code	Ref.	Ø	Quantity
2209001	B9	4/2	100
2209002	B9	6/4	50
2209003	B9	8/6	50
2209004	B9	10/8	50
2209005	B9	12/10	10
2209006	B9	15/12	10

INTERNAL BUSH (B12)



Code	Ref.	Ø	Quantity
2212001	B12	6/4	100
2212002	B12	8/6	100
2212003	B12	10/8	100
2212004	B12	12/10	100
2212005	B12	15/12	100

## QUICK FITTINGS SERIES C

### STRAIGHT, MALE CONICAL (C1)



Code	Ref.	Ø	Thread	Quantity
2301017	C1	5/3	1/8	100
2301001	C1	6/4	1/8	100
2301002	C1	6/4	1/4	50
2301003	C1	8/6	1/8	100
2301004	C1	8/6	1/4	100
2301005	C1	8/6	3/8	50
2301020	C1	10/8	1/8	50
2301006	C1	10/8	1/4	50
2301007	C1	10/8	3/8	50
2301008	C1	10/8	1/2	25
2301009	C1	12/10	3/8	50
2301010	C1	12/10	1/2	25
2301015	C1	15/12.5	1/2	50

### STRAIGHT, CONNECTOR (C3)



Code	Ref.	Ø	Quantity
2303001	C3	6/4	100
2303002	C3	8/6	50
2303003	C3	10/8	100
2303004	C3	12/10	50

### ELBOW, MALE METRIC THREAD (C5/C)



Code	Ref.	Ø	Thread	Quantity
2357001	C5/C	6/4	M12x1.5	50
2357002	C5/C	8/6	M12x1.5	50

### TEE, LATERAL MALE (C8)



Code	Ref.	Ø	Thread	Quantity
2308012	C8	5/3	1/8	100
2308001	C8	6/4	1/8	100
2308002	C8	6/4	1/4	50
2308003	C8	8/6	1/8	50
2308004	C8	8/6	1/4	50
2308005	C8	8/6	3/8	50
2308006	C8	10/8	1/4	50
2308007	C8	10/8	3/8	25
2308008	C8	10/8	1/2	25
2308009	C8	12/10	3/8	25
2308010	C8	12/10	1/2	25

### STRAIGHT, MALE PARALLEL WITH O-RING (C1/Z)



Code	Ref.	Ø	Thread	Quantity
2351001	C1/Z	4/2	M5	100
2351002	C1/Z	6/4	M5	100
2351003	C1/Z	6/4	1/8	50
2351004	C1/Z	6/4	1/4	50
2351005	C1/Z	8/6	1/8	100
2351006	C1/Z	8/6	1/4	50
2351007	C1/Z	8/6	3/8	100
2351008	C1/Z	10/8	1/4	100
2351009	C1/Z	10/8	3/8	50
2351010	C1/Z	10/8	1/2	50
2351011	C1/Z	12/10	3/8	25
2351012	C1/Z	12/10	1/2	50

### BULKHEAD CONNECTOR (C4)



Code	Ref.	Ø	Quantity
2304001	C4	6/4	100
2304002	C4	8/6	50
2304003	C4	10/8	50
2304004	C4	12/10	50

### ELBOW CONNECTOR (C6)



Code	Ref.	Ø	Quantity
2306001	C6	6/4	50
2306002	C6	8/6	100
2306003	C6	10/8	50
2306004	C6	12/10	25
2306006	C6	15/12.5	25

### TEE CONNECTOR (C9)



Code	Ref.	Ø	Quantity
2309001	C9	6/4	100
2309002	C9	8/6	50
2309003	C9	10/8	50
2309004	C9	12/10	25
2309007	C9	15/12.5	25

### STRAIGHT, MALE METRIC THREAD (C1/C)



Code	Ref.	Ø	Thread	Quantity
2356001	C1/C	5/3	M5	50
2356002	C1/C	6/4	M6	50
2356003	C1/C	6/4	M12x1.5	50
2356004	C1/C	6/4	3/8	50
2356005	C1/C	8/6	M12x1.5	50

### ELBOW, MALE CONICAL (C5)



Code	Ref.	Ø	Thread	Quantity
2305016	C5	5/3	1/8	100
2305001	C5	6/4	1/8	50
2305002	C5	6/4	1/4	50
2305003	C5	8/6	1/8	50
2305004	C5	8/6	1/4	100
2305005	C5	8/6	3/8	100
2305006	C5	10/8	1/4	25
2305007	C5	10/8	3/8	50
2305008	C5	10/8	1/2	50
2305009	C5	12/10	3/8	50
2305010	C5	12/10	1/2	50
2305017	C5	15/12.5	1/2	25

### TEE, CENTRAL MALE (C7)



Code	Ref.	Ø	Thread	Quantity
2307015	C7	5/3	1/8	100
2307001	C7	6/4	1/8	100
2307002	C7	6/4	1/4	50
2307003	C7	8/6	1/8	50
2307004	C7	8/6	1/4	50
2307005	C7	8/6	3/8	50
2307006	C7	10/8	1/4	50
2307007	C7	10/8	3/8	25
2307008	C7	10/8	1/2	25
2307009	C7	12/10	3/8	25
2307010	C7	12/10	1/2	50
2307016	C7	15/12.5	1/2	25

### NUT (C10)



Code	Ref.	Ø	Thread	Quantity
2310001	C10	4/2	M7x0.5	100
2310009	C10	5/3	M7x0.5	100
2310002	C10	6/4-M5	M8x0.5	100
2310003	C10	6/4	M10x1	100
2310004	C10	8/6	M12x1	100
2310005	C10	10/8	M14x1	100
2310006	C10	12/10	M16x1	50
2310011	C10	15/12.5	M20x1	50

### STRAIGHT, FEMALE (C2)



Code	Ref.	Ø	Thread	Quantity
2302001	C2	6/4	1/8	100
2302002	C2	6/4	1/4	50
2302003	C2	8/6	1/8	100
2302004	C2	8/6	1/4	50
2302005	C2	8/6	3/8	50
2302006	C2	10/8	1/4	100
2302007	C2	10/8	3/8	50
2302008	C2	10/8	1/2	25

### ELBOW FEMALE (C5/F)



Code	Ref.	Ø	Thread	Quantity
2352001	C5/F	6/4	1/8	50
2352002	C5/F	8/6	1/4	50

### EQUAL CROSS CONNECTOR (C11)



Code	Ref.	Ø	Quantity
2311001	C11	6/4	50
2311002	C11	8/6	50
2311003	C11	10/8	25

## BANJO FITTINGS SERIES D

### SINGLE BANJO BODY (D5)



Code	Ref.	Ø	Ø FOR:	Quantity
2405000	D5	4/2	M5	100
2405013	D5	5/3	1/8	100
2405018	D5	5/3	M5	100
2405001	D5	6/4	M5	100
2405002	D5	6/4	1/8	100
2405003	D5	6/4	1/4	100
2405005	D5	8/6	1/8	100
2405006	D5	8/6	1/4	100
2405007	D5	8/6	3/8	25
2405009	D5	10/8	1/4	50
2405010	D5	10/8	3/8	50
2405011	D5	10/8	1/2	20
2405012	D5	12/10	1/2	50
2405017	D5	12/10	3/8	20

### BANJO STEM SINGLE (D7)



Code	Ref.	Thread	Quantity
Version with washer D11 for models R13-R14-D12-D17-D5-D6			
2407001	D7	M5	100
2407002	D7	1/8	100
2407003	D7	1/4	50
2407004	D7	3/8	50
2407005	D7	1/2	25
2407006	D7	M12x1.5	50
Version with O-ring for models R28-R29			
2407102	D7 with OR	1/8	100
2407103	D7 with OR	1/4	100
2407104	D7 with OR	3/8	100

### BANJO PASSING TROUGH SINGLE (D9)



Code	Ref.	Thread	Quantity
Version with washer D11 for models R13-R14-D5-D6-D12-D17			
2409001	D9	1/8	100
2409002	D9	1/4	50
2409003	D9	3/8	20
2409004	D9	1/2	25
Versione con OR per mod. R28-R29			
2409102	D9	1/8	100
2409103	D9	1/4	50
2409104	D9	3/8	20

### WASHER (D11)



Code	Ref.	Ø FOR:	Quantity
2411001	D11	M5 (nylon)	100
2411002	D11	1/8	200
2411003	D11	1/4	100
2411004	D11	3/8	100
2411005	D11	1/2	100

### DOUBLE BANJO BODY (D6)



Code	Ref.	Ø	Ø FOR:	Quantity
2406001	D6	6/4	1/8	100
2406002	D6	6/4	1/4	50
2406004	D6	8/6	1/8	50
2406005	D6	8/6	1/4	50
2406006	D6	8/6	3/8	50
2406008	D6	10/8	1/4	50
2406009	D6	10/8	3/8	25
2406010	D6	10/8	1/2	25
2406011	D6	12/10	1/2	25

### BANJO STEM DOUBLE (D8)



Code	Ref.	Thread	Quantity
Version with washer D11 for models R13-R14-D5-D6-D12-D17			
2408001	D8	1/8	100
2408002	D8	1/4	50
2408003	D8	3/8	20
2408004	D8	1/2	25
Version with O-ring for models R28-R29			
2408102	D8 with OR	1/8	100
2408103	D8 with OR	1/4	100
2408104	D8 with OR	3/8	100

### BANJO PASSING TROUGH STEM DOUBLE (D10)



Code	Ref.	Thread	Quantity
Version with washer D11 for models R13-R14-D5-D6-D12-D17			
2410001	D10	1/8	100
2410002	D10	1/4	50
2410003	D10	3/8	25
2410004	D10	1/2	10
Version with O-ring for models R28-R29			
2410102	D10 with OR	1/8	100
2410103	D10 with OR	1/4	100
2410104	D10 with OR	3/8	100

### SINGLE BANJO PASSING TROUGH BODY (D12)



Code	Ref.	Thread	Ø FOR:	Quantity
2412001	D12	1/8	1/8	50
2412002	D12	1/4	1/4	50
2412003	D12	3/8	3/8	50

### SINGLE BANJO WITH "B" INTERFACE (D17)



Code	Ref.	Ø	Ø FOR:	Quantity
2417006	D17	4/2	1/8	50
2417002	D17	6/4	1/8	50
2417003	D17	6/4	1/4	50
2417004	D17	8/6	1/8	50
2417005	D17	8/6	1/4	50

## TAPERED THREAD FITTINGS WITH PTFE

Metal Work can supply fittings with a tapered thread coated in polytetrafluorethylene. This coating can be used with all Metal Work products that have a 1/8" to 1/2" gas taper thread, particularly the following:

- push-in fittings type R1C, R31C, R32C and R39C
- series A fittings types A2, A4, A5, A10, A12, A13, A15, A16, A17, A18 and A25
- series B bicone fittings, types B1, B5, B7 and B8
- series C push-in fittings, types C1, C5, C7, C8.



TECHNICAL FEATURES	
Threaded coupling covered by PTFE	1/8" - 1/4" - 3/8" - 1/2"
Temperature range for PTFE	- 45 to + 80 - 49 to + 176
Pressure range	Except for limitations established for the fitting on which PTFE is applied.
Fluid	The same as for the fitting on which PTFE is applied. Vacuum, compressed air.

### KEY TO CODES

Fittings with a PTFE thread have the same code as the standard fitting, with the addition of the suffix T.

### Example

The 1/8" 1/8" A2 fitting has code 2102001, so the PTFE version has code 2102001T.



### CONFORMITY DECLARATIONS

- DM 174
- DM 21/03/73
- Regulation 1935/04 EU.\*
- Regulation 2023/06 EU.

- \* Release tests performed at 100 °C for 3 successive 30-minute attacks with 4% acetic acid solution and distilled water



## PUSH-IN FITTINGS, SERIES XR STAINLESS STEEL

### TECHNICAL DATA

Threaded coupling		M5 - 1/8" - 1/4" - 3/8" - 1/2"
Diameter	mm	Ø4 - Ø6 - Ø8 - Ø10 - Ø12
Temperature range	°C	- 20 to +150
	°F	- 4 to +302
Pressure range		- 0.99 bar to 18 bar / - 0.099 MPa to 1.8 MPa
Recommended pipe		PTFE
Fluid		Vacuum - Compressed air

### STRAIGHT, CYLINDRICAL, MALE (XR1)



Code	Ref.	Ø	Thread	Quantity
2L01001X	XR1	4	M5	10
2L01002X	XR1	4	1/8	10
2L01000X	XR1	6	M5	10
2L01007X	XR1	6	1/8	10
2L01008X	XR1	6	1/4	10
2L01009X	XR1	8	1/8	10
2L01010X	XR1	8	1/4	10
2L01012X	XR1	10	1/4	10
2L01013X	XR1	10	3/8	10
2001014X	XR1	12	3/8	10
2001015X	XR1	12	1/2	10

### TEE, INTERMEDIATE (XR5)



Code	Ref.	Ø	Quantity
2L05001X	XR5	4	10
2L05003X	XR5	6	10
2L05004X	XR5	8	10
2L05005X	XR5	10	10
2L05006X	XR5	12	10

### BANJO STEM SINGLE (XD7)



Code	Ref.	Thread	Quantity
2407002X	XD7	1/8	10
2407003X	XD7	1/4	10
2407004X	XD7	3/8	10
2407005X	XD7	1/2	10

### CENTRAL TEE, MALE, CYLINDRICAL, ROTARY (XR32)



Code	Ref.	Ø	Thread	Quantity
2L32001X	XR32	4	M5	10
2L32002X	XR32	4	1/8	10
2L32008X	XR32	6	1/8	10
2L32009X	XR32	6	1/4	10
2L32010X	XR32	8	1/8	10
2L32011X	XR32	8	1/4	10
2L32013X	XR32	10	1/4	10
2L32014X	XR32	10	3/8	10

### STRAIGHT, CONICAL, MALE (XR1C)



Code	Ref.	Ø	Thread	Quantity
2L01C02X	XR1C	4	1/8	10
2L01C03X	XR1C	4	1/4	10
2L01C07X	XR1C	6	1/8	10
2L01C08X	XR1C	6	1/4	10
2L01C09X	XR1C	8	1/8	10
2L01C10X	XR1C	8	1/4	10
2L01C13X	XR1C	10	1/4	10
2L01C14X	XR1C	10	3/8	10
2001C15X	XR1C	12	3/8	10
2001C16X	XR1C	12	1/2	10

### REDUCER (XR8)



Code	Ref.	Ø 1	Ø 2	Quantity
2L08002X	XR8	6	4	10
2L08006X	XR8	8	6	10
2L08008X	XR8	10	8	10

### ROTARY ELBOW, MALE, CYLINDRICAL (XR31)



Code	Ref.	Ø	Thread	Quantity
2L31001X	XR31	4	M5	10
2L31002X	XR31	4	1/8	10
2L31007X	XR31	6	M5	10
2L31008X	XR31	6	1/8	10
2L31009X	XR31	6	1/4	10
2L31010X	XR31	8	1/8	10
2L31011X	XR31	8	1/4	10
2L31013X	XR31	10	1/4	10
2L31014X	XR31	10	3/8	10
2031017X	XR31	12	3/8	10
2031018X	XR31	12	1/2	10

### CENTRAL TEE, MALE, CONICAL, ROTARY (XR32C)



Code	Ref.	Ø	Thread	Quantity
2L32C02X	XR32C	4	1/8	10
2L32C08X	XR32C	6	1/8	10
2L32C09X	XR32C	6	1/4	10
2L32C10X	XR32C	8	1/8	10
2L32C11X	XR32C	8	1/4	10
2L32C13X	XR32C	10	1/4	10
2L32C14X	XR32C	10	3/8	10

### STRAIGHT, INTERMEDIATE (XR3)



Code	Ref.	Ø 1	Ø 2	Quantity
2L03001X	XR3	4	4	10
2L03301X	XR3	4	6	10
2L03003X	XR3	6	6	10
2L03303X	XR3	6	8	10
2L03004X	XR3	8	8	10
2L03005X	XR3	10	10	10
2003006X	XR3	12	12	10

### STRAIGHT, INTERMEDIATE, BULKMTAD (XR10)



Code	Ref.	Ø 1	Ø 2	Quantity
2L11001X	XR10	4	4	10
2L11003X	XR10	6	6	10
2L11004X	XR10	8	8	10
2L11005X	XR10	10	10	10
2L11006X	XR10	12	12	10

### SINGLE RING (XR13)



Code	Ref.	Ø	Ø FOR:	Quantity
2012002X	XR13	4	1/8	10
2012005X	XR13	6	1/8	10
2012006X	XR13	6	1/4	10
2012007X	XR13	8	1/8	10
2012008X	XR13	8	1/4	10
2012010X	XR13	10	1/4	10
2012011X	XR13	10	3/8	10
2012012X	XR13	12	3/8	10
2012014X	XR13	12	1/2	10

### ROTARY ELBOW, MALE, CONICAL (XR31C)



Code	Ref.	Ø	Thread	Quantity
2L31C02X	XR31C	4	1/8	10
2L31C08X	XR31C	6	1/8	10
2L31C09X	XR31C	6	1/4	10
2L31C10X	XR31C	8	1/8	10
2L31C11X	XR31C	8	1/4	10
2L31C13X	XR31C	10	1/4	10
2L31C14X	XR31C	10	3/8	10
2031C15X	XR31C	12	3/8	10
2031C16X	XR31C	12	1/2	10

### ELBOW, INTERMEDIATE (XR4)



Code	Ref.	Ø	Quantity
2L04001X	XR4	4	10
2L04003X	XR4	6	10
2L04004X	XR4	8	10
2L04005X	XR4	10	10
2L04006X	XR4	12	10

### ELBOW, MALE, CONICAL (XR39C)



Code	Ref.	Ø	Thread	Quantity
2L39C02X	XR39C	4	1/8	10
2L39C08X	XR39C	6	1/8	10
2L39C09X	XR39C	6	1/4	10
2L39C10X	XR39C	8	1/8	10
2L39C11X	XR39C	8	1/4	10
2L39C13X	XR39C	10	1/4	10

## STANDARD FITTINGS SERIES XA

### NIPPLE, CONICAL (XA2)



Code	Ref.	Thread	Thread 1	Quantity
2102001X	XA2	1/8	1/8	10
2102002X	XA2	1/8	1/4	10
2102004X	XA2	1/4	1/4	10
2102005X	XA2	1/4	3/8	10
2102007X	XA2	3/8	3/8	10
2102008X	XA2	3/8	1/2	10
2102009X	XA2	1/2	1/2	10

### REDUCER, PARALLEL (XA4Z)



Code	Ref.	Thread	Thread 1	Quantity
2151000X	XA4Z	1/8	M5	10
2151001X	XA4Z	1/4	1/8	10
2151003X	XA4Z	3/8	1/4	10

### ELBOW, FEMALE (XA9)



Code	Ref.	Thread	Quantity
2109001X	XA9	1/8	10
2109002X	XA9	1/4	10
2109003X	XA9	3/8	10
2109004X	XA9	1/2	10

### TEE, CENTRAL MALE (XA12)



Code	Ref.	Thread	Thread 1	Quantity
2112001X	XA12	1/8	1/8	10
2112002X	XA12	1/4	1/4	10
2112003X	XA12	3/8	3/8	10
2112004X	XA12	1/2	1/2	10

### SLEEVE (XA3)



Code	Ref.	Thread	Quantity
2103001X	XA3	1/8	10
2103002X	XA3	1/4	10
2103003X	XA3	3/8	10
2103004X	XA3	1/2	10

### PLUG WITH EXAGON EMBEDDED (XA7)



Code	Ref.	Thread	Quantity
2107001X	XA7	1/8	10
2107002X	XA7	1/4	10
2107003X	XA7	3/8	10
2107004X	XA7	1/2	10

### ELBOW, MALE-FEMALE (XA10)



Code	Ref.	Thread	Thread 1	Quantity
2110001X	XA10	1/8	1/8	10
2110002X	XA10	1/4	1/4	10
2110003X	XA10	3/8	3/8	10
2110004X	XA10	1/2	1/2	10

### ELBOW, MALE (XA15)



Code	Ref.	Thread	Quantity
2115001X	XA15	1/8	10
2115002X	XA15	1/4	10
2115003X	XA15	3/8	10
2115004X	XA15	1/2	10

### REDUCER, CONICAL (XA4)



Code	Ref.	Thread	Thread 1	Quantity
2104001X	XA4	1/4	1/8	10
2104002X	XA4	3/8	1/8	10
2104009X	XA4	1/2	1/8	10
2104003X	XA4	3/8	1/4	10
2104004X	XA4	1/2	1/4	10
2104005X	XA4	1/2	3/8	10

### TAPER MALE PLUG (XA7C)



Code	Ref.	Thread	Quantity
2107C01X	XA7C	1/8	10
2107C02X	XA7C	1/4	10
2107C03X	XA7C	3/8	10
2107C04X	XA7C	1/2	10

### TEE, FEMALE (XA11)



Code	Ref.	Thread	Quantity
2111001X	XA11	1/8	10
2111002X	XA11	1/4	10
2111003X	XA11	3/8	10
2111004X	XA11	1/2	10

### SINGLE BANJO PASSING TROUGH BODY (XD12)



Code	Ref.	Thread	Ø FOR:	Quantity
2412001X	XD12	1/8	1/8	10
2412002X	XD12	1/4	1/4	10
2412003X	XD12	3/8	3/8	10
2412004X	XD12	1/2	1/2	10

## QUICK FITTINGS SERIES XC

### STRAIGHT, MALE CONICAL (XC1)



Code	Ref.	Ø	Thread	Quantity
2301001X	XC1	6/4	1/8	10
2301002X	XC1	6/4	1/4	10
2301003X	XC1	8/6	1/8	10
2301004X	XC1	8/6	1/4	10
2301006X	XC1	10/8	1/4	10
2301007X	XC1	10/8	3/8	10

### ELBOW, MALE CONICAL (XC5)



Code	Ref.	Ø	Thread	Quantity
2305001X	XC5	6/4	1/8	10
2305002X	XC5	6/4	1/4	10
2305003X	XC5	8/6	1/8	10
2305004X	XC5	8/6	1/4	10
2305006X	XC5	10/8	1/4	10

### TEE, CENTRAL MALE (XC7)



Code	Ref.	Ø	Thread	Quantity
2307001X	XC7	6/4	1/8	10
2307002X	XC7	6/4	1/4	10
2307003X	XC7	8/6	1/8	10
2307004X	XC7	8/6	1/4	10
2307006X	XC7	10/8	1/4	10

### TEE CONNECTOR (XC9)



Code	Ref.	Ø	Quantity
2309001X	XC9	6/4	10
2309002X	XC9	8/6	10
2309003X	XC9	10/8	10

### STRAIGHT, CONNECTOR (XC3)



Code	Ref.	Ø	Quantity
2303001X	XC3	6/4	10
2303002X	XC3	8/6	10
2303003X	XC3	10/8	10

### ELBOW CONNECTOR (XC6)



Code	Ref.	Ø	Quantity
2306001X	XC6	6/4	10
2306002X	XC6	8/6	10
2306003X	XC6	10/8	10

### TEE, LATERAL MALE (XC8)



Code	Ref.	Ø	Thread	Quantity
2308001X	XC8	6/4	1/8	10
2308002X	XC8	6/4	1/4	10
2308003X	XC8	8/6	1/8	10
2308004X	XC8	8/6	1/4	10
2308006X	XC8	10/8	1/4	10

### NUT (XC10)



Code	Ref.	Ø	Quantity
2310002X	XC10	6/4	10
2310004X	XC10	8/6	10
2310005X	XC10	10/8	10

## IN-LINE PNEUMATIC VALVE SERIES PNV L



TECHNICAL DATA		Ø 6	Ø 8 (Ø5/16")
Max. operating pressure	MPa		1
	bar		10
	psi		145
Temperature range	°C		- 20 to + 60
	°F		- 4 to + 140
Recommended pipe Fluid		Rilsan PA 11 - Nylon 6 - Polyamide 12 - Polypropylene Lubricated or unlubricated filtered compressed air; if used, must be continuous	

### PNV L 3/2 NC PIPE - PIPE



Code	Ref.
9067616	PNV L 3/2 NC 6-6
9067624	PNV L 3/2 NC 8-8 ▲

▲ Ø 8 = Ø 5/16"

### PNV L 3/2 NC PIPE (1) - THREAD (2)



Code	Ref.
9067808	PNV L 3/2 NC 6-1/8
9067809	PNV L 3/2 NC 6-1/4
9067810	PNV L 3/2 NC 8-1/8 ▲
9067811	PNV L 3/2 NC 8-1/4 ▲
9067812	PNV L 3/2 NC 8-3/8 ▲

▲ Ø 8 = Ø 5/16"

### PNV L 3/2 NC THREAD (1) - PIPE (2)



Code	Ref.
9067708	PNV L 3/2 NC 1/8-6
9067709	PNV L 3/2 NC 1/4-6
9067710	PNV L 3/2 NC 1/8-8 ▲
9067711	PNV L 3/2 NC 1/4-8 ▲
9067712	PNV L 3/2 NC 3/8-8 ▲

▲ Ø 8 = Ø 5/16"

## IN-LINE SOLENOID VALVE SERIES SOV L

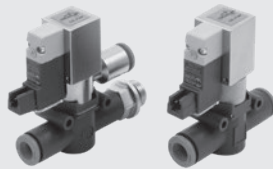

TECHNICAL DATA		Ø 6	Ø 1/4	Ø 8 (Ø 5/16")
Operating pressure	MPa		0.25 to 0.7	
	bar		2.5 to 7	
	psi		36 to 101	
Temperature range	°C		-10 to +60	
	°F		+14 to +140	
Flow rate at 6.3 bar ΔP 0.5bar	NI/min	270	270	500
Flow rate at 6.3 bar ΔP 1 bar	NI/min	380	380	700
Conductance C	NI/min-bar	95.8	95.8	178.1
Coefficient b	bar/bar	0.145	0.145	0.129
Voltage	VDC		24	
Power			0.9	
Recommended pipe Fluid		Rilsan PA11 - Nylon 6 - Polyamide 12 - Polypropylene Lubricated or unlubricated filtered compressed air; if used, must be continuous		

### SOV L 3/2 NC-NO PIPE (1) - PIPE (2) SILENCED EXHAUST (3)

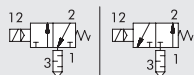

Code	Ref.
9069016	SOV L 3/2 NC 6-6
9069116	SOV L 3/2 NO 6-6
9069016U	SOV L 3/2 NC 1/4-1/4
9069116U	SOV L 3/2 NO 1/4-1/4
9069024	SOV L 3/2 NC 8-8 ▲
9069124	SOV L 3/2 NO 8-8 ▲

▲ Ø 8 = Ø 5/16"

### SOV L 3/2 NC-NO PIPE (1) - THREAD (2) SILENCED EXHAUST (3)

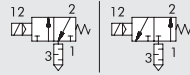

Code	Ref.
9069408	SOV L 3/2 NC 6-1/8
9069508	SOV L 3/2 NO 6-1/8
9069409	SOV L 3/2 NC 6-1/4
9069509	SOV L 3/2 NO 6-1/4
9069410	SOV L 3/2 NC 8-1/8 ▲
9069510	SOV L 3/2 NO 8-1/8 ▲
9069411	SOV L 3/2 NC 8-1/4 ▲
9069511	SOV L 3/2 NO 8-1/4 ▲
9069412	SOV L 3/2 NC 8-3/8 ▲
9069512	SOV L 3/2 NO 8-3/8 ▲

▲ Ø 8 = Ø 5/16"

### SOV L 3/2 NC-NO PIPE (1) - PIPE (2) CONVEYED EXHAUST (3)

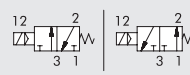

Code	Ref.
9069216	SOV L 3/2 NC 6-6-6
9069316	SOV L 3/2 NO 6-6-6
9069216U	SOV L 3/2 NC 1/4-1/4-1/4
9069316U	SOV L 3/2 NO 1/4-1/4-1/4
9069224	SOV L 3/2 NC 8-8-8 ▲
9069324	SOV L 3/2 NO 8-8-8 ▲

▲ Ø 8 = Ø 5/16"

### SOV L 3/2 NC-NO PIPE (1) - THREAD (2) CONVEYED EXHAUST (3)

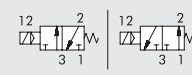

Code	Ref.
9069608	SOV L 3/2 NC 6-1/8-6
9069708	SOV L 3/2 NO 6-1/8-6
9069609	SOV L 3/2 NC 6-1/4-6
9069709	SOV L 3/2 NO 6-1/4-6
9069610	SOV L 3/2 NC 8-1/8-8 ▲
9069710	SOV L 3/2 NO 8-1/8-8 ▲
9069611	SOV L 3/2 NC 8-1/4-8 ▲
9069711	SOV L 3/2 NO 8-1/4-8 ▲
9069612	SOV L 3/2 NC 8-3/8-8 ▲
9069712	SOV L 3/2 NO 8-3/8-8 ▲

▲ Ø 8 = Ø 5/16"

## MINIATURE REDUCER/ECONOMIZER, SERIES RML, RMC AND RMS



TECHNICAL DATA		RML Ø 6	RMC 1/8	RMS 1/8	RML Ø 1/4"	RML Ø 8 (Ø5/16")	RMC 1/4	RMS 1/4
Threaded ports	G (BSP)	1/8"-1/4"	1/8"	1/8"	-	1/8"-1/4"-3/8"	1/4"	1/4"
Pipe coupling	Ø	6	4 ▲ - 6 - 8 ▲	-	1/4"	8 ▲	6 - 8 ▲ - 10	-
Regulation range		1 to 8 bar - 0.1 to 0.8 MPa - 14.5 to 116 psi						
Inlet pressure	MPa	0.2 to 1						
	bar	2 to 10						
	psi	29 to 145						
Flow rate at 6.3 bar (0.63 MPa - 91 psi) ΔP 1 bar	Nl/min	150		150		260		
Flow rate on exhaust at 6.3 bar (0.63 MPa - 91 psi)		400		400		600		
Fluid		Lubricated or unlubricated filtered compressed air; if used, must be continuous						
Max. temperature at 1 MPa; 10 bar; 145 psi	°C	- 20 to + 60						
	°F	- 4 to + 140						
Assembly position		Available						
Notes		In the miniature regulator the pressure must always be set upwards						

▲ Ø 4 = Ø 5/32"; Ø 8 = Ø 5/16"

### LINE-MOUNTED MINIATURE REDUCER, SERIES RML



Code	Ref.
9061316	RML 6-6
9061316U	RML 1/4-1/4
9061324	RML 8-8 ▲

▲ Ø 8 = Ø 5/16"

### LINE-MOUNTED MINIATURE THREAD (IN) - PIPE (OUT) SERIES RML



Code	Ref.
9061408	RML 1/8-6
9061409	RML 1/4-6
9061410	RML 1/8-8 ▲
9061411	RML 1/4-8 ▲
9061412	RML 3/8-8 ▲

▲ Ø 8 = Ø 5/16"

### LINE-MOUNTED MINIATURE PIPE (IN) - THREAD (OUT) SERIES RML



Code	Ref.
9061508	RML 6-1/8
9061509	RML 6-1/4
9061510	RML 8-1/8 ▲
9061511	RML 8-1/4 ▲
9061512	RML 8-3/8 ▲

▲ Ø 8 = Ø 5/16"

### MINIATURE REDUCER, SERIES RMC



Code	Ref.
9061102	RMC 1/8-4 ▲
9061108	RMC 1/8-6
9061110	RMC 1/8-8 ▲
9061109	RMC 1/4-6
9061111	RMC 1/4-8 ▲
9061112	RMC 1/4-10

▲ Ø 4 = Ø 5/32"; Ø 8 = Ø 5/16"

### CARTRIDGE REDUCER, SERIES RMS



Code	Ref.
9061001	RMS 1/8
9061002	RMS 1/4

### TOOL FOR RMS SEAT



Code	Ref.
9062001	UT.SE 1/8
9062002	UT.SE 1/4

## IN-LINE PRESSURE GAUGE SERIES MAN L



TECHNICAL DATA		Ø 4 (Ø5/32")	Ø 6	Ø 1/4"	Ø 8 (Ø5/16")
Operating pressure	MPa			1.2	
	bar			12	
	psi			174	
Temperature range	°C			- 20 to + 60	
	°F			- 4 to + 140	
Precision				± 4% full scale	
Recommended pipe		Rilsan PA11 - Nylon 6 - Polyamide 12 - Polypropylene			
Fluid		Lubricated or unlubricated filtered compressed air; if used, must be continuous			

### MAN L PIPE-PIPE



Code	Ref.
9067001	MAN L 4-4 ▲
9067016	MAN L 6-6
9067016U	MAN L 1/4-1/4
9067024	MAN L 8-8 ▲

▲ Ø 4 = Ø 5/32"; Ø 8 = Ø 5/16"

### MAN L THREAD-PIPE



Code	Ref.
9067101	MAN L M5-4 ▲
9067102	MAN L 1/8-4 ▲
9067108	MAN L 1/8-6
9067109	MAN L 1/4-6
9067110	MAN L 1/8-8 ▲
9067111	MAN L 1/4-8 ▲
9067112	MAN L 3/8-8 ▲

▲ Ø 4 = Ø 5/32"; Ø 8 = Ø 5/16"

## IN-LINE PRESSURE INDICATOR SERIES LAM L



TECHNICAL DATA		Ø 6	Ø 1/4"	Ø 8 (Ø5/16")
Operating pressure	MPa bar psi		0.2 to 1 2 to 10 29 to 145	
Temperature range	°C °F		- 20 to + 60 - 4 to + 140	
Flow rate at 6.3 bar ΔP 1 bar	Nl/min	420	420	800
Colour with pressure		Orange - Green		
Recommended pipe		Rilsan PA11 - Nylon 6 - Polyamide 12 - Polypropylene		
Fluid		Lubricated or unlubricated filtered compressed air; if used, must be continuous		

### LAM L PIPE-PIPE



Código	Ref.
9068016	LAM L 6-6-A
9068216	LAM L 6-6-V
9068016U	LAM L 1/4-1/4-A
9068216U	LAM L 1/4-1/4-V
9068024	LAM L 8-8-A ▲
9068224	LAM L 8-8-V ▲

A = Orange; V = Green  
▲ Ø 8 = Ø 5/16"

### LAM L THREAD-PIPE



Código	Ref.
9068108	LAM L 1/8-6-A
9068308	LAM L 1/8-6-V
9068109	LAM L 1/4-6-A
9068309	LAM L 1/4-6-V
9068110	LAM L 1/8-8-A ▲
9068310	LAM L 1/8-8-V ▲
9068111	LAM L 1/4-8-A ▲
9068311	LAM L 1/4-8-V ▲
9068112	LAM L 3/8-8-A ▲
9068312	LAM L 3/8-8-V ▲

A = Orange; V = Green  
▲ Ø 8 = Ø 5/16"

## IN-LINE SHUTOFF VALVE SERIES V2V L AND V3V L



TECHNICAL DATA		Ø 6	Ø 1/4"	Ø 8 (Ø5/16")
Operating pressure	MPa bar psi		1 10 145	
Temperature range	°C °F		- 20 to + 60 - 4 to + 140	
Flow rate at 6.3 bar ΔP 1 bar	Nl/min	280	280	470
Exhaust flow rate at 6.3 bar	Nl/min	110	110	110
Recommended pipe		Rilsan PA11 - Nylon 6 - Polyamide 12 - Polypropylene		
Fluid		Lubricated or unlubricated filtered compressed air; if used, must be continuous		

### V2V/V3V L PIPE-PIPE



Code	Ref.
9065016	V2V L 6-6
9066016	V3V L 6-6
9065016U	V2V L 1/4-1/4
9066016U	V3V L 1/4-1/4
9065024	V2V L 8-8 ▲
9066024	V3V L 8-8 ▲

▲ Ø 8 = Ø 5/16"

### V2V/V3V L PIPE-PIPE PADLOCKED



Code	Ref.
9065116	V2V L 6-6 KEY
9066116	V3V L 6-6 KEY
9065116U	V2V L 1/4-1/4 KEY
9066116U	V3V L 1/4-1/4 KEY
9065124	V2V L 8-8 KEY ▲
9066124	V3V L 8-8 KEY ▲

▲ Ø 8 = Ø 5/16"

### V2V/V3V L PIPE (IN) - THREAD (OUT)



Code	Ref.
9065208	V2V L 6-1/8
9066208	V3V L 6-1/8
9065209	V2V L 6-1/4
9066209	V3V L 6-1/4
9065210	V2V L 8-1/8 ▲
9066210	V3V L 8-1/8 ▲
9065211	V2V L 8-1/4 ▲
9066211	V3V L 8-1/4 ▲
9065212	V2V L 8-3/8 ▲
9066212	V3V L 8-3/8 ▲

▲ Ø 8 = Ø 5/16"

### V2V/V3V L PIPE (IN) - THREAD (OUT) PADLOCKED



Code	Ref.
9065308	V2V L 6-1/8 KEY
9066308	V3V L 6-1/8 KEY
9065309	V2V L 6-1/4 KEY
9066309	V3V L 6-1/4 KEY
9065310	V2V L 8-1/8 KEY ▲
9066310	V3V L 8-1/8 KEY ▲
9065311	V2V L 8-1/4 KEY ▲
9066311	V3V L 8-1/4 KEY ▲
9065312	V2V L 8-3/8 KEY ▲
9066312	V3V L 8-3/8 KEY ▲

▲ Ø 8 = Ø 5/16"

### V2V/V3V L THREAD (IN) - PIPE (OUT)



Code	Ref.
9065408	V2V L 1/8-6
9066408	V3V L 1/8-6
9065409	V2V L 1/4-6
9066409	V3V L 1/4-6
9065410	V2V L 1/8-8 ▲
9066410	V3V L 1/8-8 ▲
9065411	V2V L 1/4-8 ▲
9066411	V3V L 1/4-8 ▲
9065412	V2V L 3/8-8 ▲
9066412	V3V L 3/8-8 ▲

▲ Ø 8 = Ø 5/16"

### V2V/V3V L THREAD (IN) - PIPE (OUT) PADLOCKED



Code	Ref.
9065508	V2V L 1/8-6 KEY
9066508	V3V L 1/8-6 KEY
9065509	V2V L 1/4-6 KEY
9066509	V3V L 1/4-6 KEY
9065510	V2V L 1/8-8 KEY ▲
9066510	V3V L 1/8-8 KEY ▲
9065511	V2V L 1/4-8 KEY ▲
9066511	V3V L 1/4-8 KEY ▲
9065512	V2V L 3/8-8 KEY ▲
9066512	V3V L 3/8-8 KEY ▲

▲ Ø 8 = Ø 5/16"

## IN-LINE FLOW MICRO-REGULATOR SERIE RFL L



TECHNICAL DATA		Ø 4 (Ø5/32")	Ø 6	Ø 1/4"	Ø 8 (Ø5/16")
Max. operating pressure	MPa bar psi			1 10 145	
Temperature range	°C °F			- 20 to + 60 - 4 to + 140	
Max flow rate on regulation at 6.3 bar	Nl/min	155	450	450	850
Flow rate on exhaust at 6.3 bar	Nl/min	160	550	550	950
Adjustment		Manual or using a screwdriver Tapered needle			
Internal system		Rilsan PA 11 - Nylon 6 - Polyamide 12 - Polypropylene			
Recommended pipe		Lubricated or unlubricated filtered compressed air; if used, must be continuous			
Fluid					

### RFL L PIPE-PIPE UNIDIRECTIONAL



Code	Ref.
9041301	RFL LU 4-4 ▲
9041316	RFL LU 6-6
9041316U	RFL LU 1/4-1/4
9041324	RFL LU 8-8 ▲

▲ Ø 4 = Ø 5/32"; Ø 8 = Ø 5/16"

### RFL L THREAD-PIPE UNIDIRECTIONAL CYLINDER VERSION



Code	Ref.
9041401	RFL LU M5-4 ▲
9041402	RFL LU 1/8-4 ▲
9041408	RFL LU 1/8-6
9041409	RFL LU 1/4-6
9041410	RFL LU 1/8-8 ▲
9041411	RFL LU 1/4-8 ▲
9041412	RFL LU 3/8-8 ▲

▲ Ø 4 = Ø 5/32"; Ø 8 = Ø 5/16"

### RFL L PIPE-THREAD UNIDIRECTIONAL VALVE VERSION



Code	Ref.
9041501	RFL LU 4-M5 ▲
9041502	RFL LU 4-1/8 ▲
9041508	RFL LU 6-1/8
9041509	RFL LU 6-1/4
9041510	RFL LU 8-1/8 ▲
9041511	RFL LU 8-1/4
9041512	RFL LU 8-3/8 ▲

▲ Ø 4 = Ø 5/32"; Ø 8 = Ø 5/16"

### RFL L PIPE-PIPE BIDIRECTIONAL



Code	Ref.
9041601	RFL LB 4-4 ▲
9041616	RFL LB 6-6
9041616U	RFL LB 1/4-1/4
9041624	RFL LB 8-8 ▲

▲ Ø 4 = Ø 5/32"; Ø 8 = Ø 5/16"

### RFL L THREAD-PIPE BIDIRECTIONAL



Code	Ref.
9041701	RFL LB M5-4 ▲
9041702	RFL LB 1/8-4 ▲
9041708	RFL LB 1/8-6
9041709	RFL LB 1/4-6
9041710	RFL LB 1/8-8 ▲
9041711	RFL LB 1/4-8 ▲
9041712	RFL LB 3/8-8 ▲

▲ Ø 4 = Ø 5/32"; Ø 8 = Ø 5/16"

## IN-LINE QUICK-EXHAUST VALVES SERIES VSR L



TECHNICAL DATA		Ø 4 (Ø5/32")	Ø 6	Ø 1/4"	Ø 8 (Ø5/16")
Inlet pressure	MPa bar psi			0.1 to 1 1 to 10 14.5 to 145	
Temperature range	°C °F			- 20 to + 60 - 4 to + 140	
Inlet flow rate at 6.3 bar ΔP 1 bar	Nl/min	50	270	270	400
Exhaust flow rate at 6.3 bar	Nl/min	100	700	700	1000
Recommended pipe		Rilsan PA 11 - Nylon 6 - Polyamide 12 - Polypropylene			
Fluid		Lubricated or unlubricated filtered compressed air; if used, must be continuous			

### VSR L PIPE-PIPE CONVEYED EXHAUST

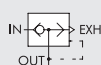

Code	Ref.
9063001	VSR L 4-4-4 ▲
9063016	VSR L 6-6-6
9063016U	VSR L 1/4-1/4-1/4
9063024	VSR L 8-8-8 ▲

▲ Ø 4 = Ø 5/32"; Ø 8 = Ø 5/16"

### VSR L PIPE-PIPE SILENCED EXHAUST

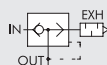

Code	Ref.
9063101	VSR L 4-4-SIL ▲
9063116	VSR L 6-6-SIL
9063116U	VSR L 1/4-1/4-SIL
9063124	VSR L 8-8-SIL ▲

▲ Ø 4 = Ø 5/32"; Ø 8 = Ø 5/16"

### VSR L PIPE (IN) - THREAD (OUT) CONVEYED EXHAUST

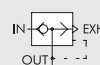

Code	Ref.
9063201	VSR L 4-M5-4 ▲
9063202	VSR L 4-1/8-4 ▲
9063208	VSR L 6-1/8-6
9063209	VSR L 6-1/4-6
9063210	VSR L 8-1/8-8 ▲
9063211	VSR L 8-1/4-8 ▲
9063212	VSR L 8-3/8-8 ▲

▲ Ø 4 = Ø 5/32"; Ø 8 = Ø 5/16"

### VSR L PIPE (IN) - THREAD (OUT) SILENCED EXHAUST

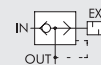

Code	Ref.
9063301	VSR L 4-M5-SIL ▲
9063302	VSR L 4-1/8-SIL ▲
9063308	VSR L 6-1/8-SIL
9063309	VSR L 6-1/4-SIL
9063310	VSR L 8-1/8-SIL ▲
9063311	VSR L 8-1/4-SIL ▲
9063312	VSR L 8-3/8-SIL ▲

▲ Ø 4 = Ø 5/32"; Ø 8 = Ø 5/16"



## IN-LINE FIXED-REGULATION FLOW REGULATOR SERIE RFF L



TECHNICAL DATA		Ø 4 (Ø5/32")	Ø 6	Ø 8 (Ø5/16")
Max. operating pressure	MPa		1	
	bar		10	
	psi		145	
Temperature range	°C		-20 to +60	
	°F		-4 to +140	
Choke flow rate	NI/min		See table below	
Recommended pipe		Rilsan PA 11 - Nylon 6 - Polyamide 12 - Polypropylene		
Fluid		Lubricated or unlubricated filtered compressed air; if used, must be continuous		

### KEY TO CODES

9 0 7 0	B	11	02
TYPE	FUNCTION	Ø IN - Ø OUT	Ø CHOKE
9070 RFF L	B Bidireccional	▲ ■ 11 = Ø 4 - Ø 4	02 = Ø 0.2
	C Cilindro	▲ * 15 = Ø 4 - M5	03 = Ø 0.3
	U Unidireccional	▲ * 16 = Ø 4 - 1/8"	04 = Ø 0.4
	V Valvula	■ 22 = Ø 6 - Ø 6	05 = Ø 0.5
		* 26 = Ø 6 - 1/8"	06 = Ø 0.6
		* 27 = Ø 6 - 1/4"	08 = Ø 0.8
		▲ ■ 33 = Ø 8 - Ø 8	10 = Ø 1.0
		▲ * 36 = Ø 8 - 1/8"	13 = Ø 1.3
		▲ * 37 = Ø 8 - 1/4"	15 = Ø 1.5
		▲ * 38 = Ø 8 - 3/8"	
		▲ ● 51 = M5 - Ø 4	
		▲ ● 61 = 1/8" - Ø 4	
		● 62 = 1/8" - Ø 6	
		▲ ● 63 = 1/8" - Ø 8	
		● 72 = 1/4" - Ø 6	
		▲ ● 73 = 1/4" - Ø 8	
		▲ ● 83 = 3/8" - Ø 8	

- ▲ Ø 4 = Ø 5/32"; Ø 8 = Ø 5/16"
- Only for B (bidirectional) and U (unidirectional) versions
- \* Only for V (valve) versions
- Only for C (cylinder) and B (bidirectional) versions

### EXHAUST FLOW RATE AT 6.3 bar FOR VERSIONS C-U-V (NI/min)

Choke (mm)	Ø 4	Ø 6	Ø 8
Ø 0.2	142	552	912
Ø 0.3	144	554	914
Ø 0.4	147	557	917
Ø 0.5	153	563	923
Ø 0.6	155	565	925
Ø 0.8	172	582	942
Ø 1.0	190	600	960
Ø 1.3	225	635	995
Ø 1.5	250	660	1020

### CHOKE FLOW-RATE AT 6 bar WITH RELIEF VALVE OPEN

Choke (mm)	Flow rate (NI/min)
Ø 0.2	2
Ø 0.3	4
Ø 0.4	7
Ø 0.5	13
Ø 0.6	15
Ø 0.8	32
Ø 1.0	50
Ø 1.3	85
Ø 1.5	110

## IN-LINE QUICK-EXHAUST VALVE WITH REGULATED EXHAUST SERIES VSRR L



TECHNICAL DATA		Ø 4 (Ø5/32")	Ø 6	Ø 8 (Ø5/16")
Max. operating pressure	MPa		1	
	bar		10	
	psi		145	
Temperature range	°C		-20 to +60	
	°F		-4 to +140	
Max flow rate on regulation at 6.3 bar ΔP 1 bar	NI/min	50	270	400
Flow rate on exhaust at 6.3 bar	NI/min	170	460	960
Adjustment		Manual or using a screwdriver		
Internal system		Tapered needle		
Recommended pipe		Rilsan PA 11 - Nylon 6 - Polyamide 12 - Polypropylene		
Fluid		Lubricated or unlubricated filtered compressed air; if used, must be continuous		

### VSRR L PIPE-PIPE

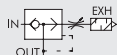

Code	Ref.
9063501	VSRR L 4-4 ▲
9063516	VSRR L 6-6
9063524	VSRR L 8-8 ▲

▲ Ø 4 = Ø 5/32"; Ø 8 = Ø 5/16"

### VSRR L THREAD (IN) - PIPE (OUT)

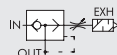

Code	Ref.
9063601	VSRR L M5-4 ▲
9063602	VSRR L 1/8-4 ▲
9063608	VSRR L 1/8-6
9063609	VSRR L 1/4-6
9063610	VSRR L 1/8-8 ▲
9063611	VSRR L 1/4-8 ▲
9063612	VSRR L 3/8-8 ▲

▲ Ø 4 = Ø 5/32"; Ø 8 = Ø 5/16"

### VSRR L PIPE (IN) - THREAD (OUT)

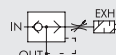

Code	Ref.
9063701	VSRR L 4-M5 ▲
9063702	VSRR L 4-1/8 ▲
9063708	VSRR L 6-1/8
9063709	VSRR L 6-1/4
9063710	VSRR L 8-1/8 ▲
9063711	VSRR L 8-1/4 ▲
9063712	VSRR L 8-3/8 ▲

▲ Ø 4 = Ø 5/32"; Ø 8 = Ø 5/16"

## IN-LINE STOP VALVE SERIES STP L



TECHNICAL DATA		Ø 6	Ø 8 (Ø5/16")
Max. operating pressure	MPa bar psi		1 10 145
Temperature range	°C °F		-20 to +60 -4 to +140
Recommended pipe Fluid		Rilsan PA 11 - Nylon 6 - Polyamide 12 - Polypropylene Lubricated or unlubricated filtered compressed air; if used, must be continuous	

### STP L 2/2 PIPE - PIPE



Code	Ref.
9065616	STP L 2/2 6 - 6
9065624	STP L 2/2 8 - 8 ▲
▲ Ø 8 = Ø 5/16"	

### STP L 2/2 PIPE (1) - THREAD (2)



Code	Ref.
9065808	STP L 2/2 6 - 1/8
9065809	STP L 2/2 6 - 1/4
9065810	STP L 2/2 8 - 1/8 ▲
9065811	STP L 2/2 8 - 1/4 ▲
9065812	STP L 2/2 8 - 3/8 ▲
▲ Ø 8 = Ø 5/16"	

### STP L 2/2 THREAD (1) - PIPE (2)



Code	Ref.
9065708	STP L 2/2 1/8 - 6
9065709	STP L 2/2 1/4 - 6
9065710	STP L 2/2 1/8 - 8 ▲
9065711	STP L 2/2 1/4 - 8 ▲
9065712	STP L 2/2 3/8 - 8 ▲
▲ Ø 8 = Ø 5/16"	

## IN-LINE CHECK VALVE SERIES VNR L



TECHNICAL DATA		Ø 4 (Ø5/32")	Ø 6	Ø 1/4"	Ø 8 (Ø5/16")
Operating pressure	MPa bar psi				0.05 to 1.2 0.5 to 12 7.2 to 174
Temperature range	°C °F				-20 to +60 -4 to +140
Flow rate at 6,3 bar ΔP 1 bar	NI/min	80	320	320	480
Recommended pipe Fluid		Rilsan PA 11 - Nylon 6 - Polyamide 12 - Polypropylene Lubricated or unlubricated filtered compressed air; if used, must be continuous			

### VNR L PIPE-PIPE



Code	Ref.
9064001	VNR L 4-4 ▲
9064016	VNR L 6-6
9064016U	VNR L 1/4-1/4
9064024	VNR L 8-8 ▲
▲ Ø 4 = Ø 5/32"; Ø 8 = Ø 5/16"	

### VNR L THREAD (IN) - PIPE (OUT)



Code	Ref.
9064101	VNR L M5-4 ▲
9064102	VNR L 1/8-4 ▲
9064108	VNR L 1/8-6
9064109	VNR L 1/4-6
9064110	VNR L 1/8-8 ▲
9064111	VNR L 1/4-8 ▲
9064112	VNR L 3/8-8 ▲
▲ Ø 4 = Ø 5/32"; Ø 8 = Ø 5/16"	

### VNR L PIPE (IN) - THREAD (OUT)

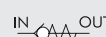

Code	Ref.
9064201	VNR L 4-M5 ▲
9064202	VNR L 4-1/8 ▲
9064208	VNR L 6-1/8
9064209	VNR L 6-1/4
9064210	VNR L 8-1/8 ▲
9064211	VNR L 8-1/4 ▲
9064212	VNR L 8-3/8 ▲
▲ Ø 4 = Ø 5/32"; Ø 8 = Ø 5/16"	

## ACCESSORIES

### PLUG-IN CONNECTOR

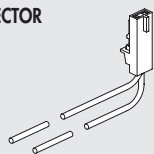

Code	Description
W0970512000	Plug-in connector Mach 11 L = 300

### FIXING SQUARE KIT



Code	Description
9062110	Square L

### U-BOLT



Code	Description
9062216	TUB L 6-6
9062216U	TUB L 1/4-1/4
9062224	TUB L 8-8 ▲
▲ Ø 8 = Ø 5/16"	

### RU6 - STEM ADAPTORS UNF or NPT



Code	Ref.	Ø	F
2U06001	RU6	5/32	10-32 UNF
2U06002	RU6	5/32	1/8 NPT
2U06003	RU6	5/32	1/4 NPT
2U06000	RU6	1/4	10-32 UNF
2U06007	RU6	1/4	1/8 NPT
2U06008	RU6	1/4	1/4 NPT
2U06020	RU6	1/4	3/8 NPT
2U06009	RU6	5/16	1/8 NPT
2U06010	RU6	5/16	1/4 NPT
2U06011	RU6	5/16	3/8 NPT

## SPARE PARTS

### PLUG-IN PILOT



Code	Description
722213541100	PLT 10 24 VDC 0.9W with LED man

## COMPRESSED AIR QUICK-FIT COUPLINGS SERIES IAC

TECHNICAL DATA		MINI		100	200	300
Threaded coupling		1/8"	1/4"	1/4"	3/8"	1/2"
Maximum inlet pressure	MPa	3		3		3
	bar	30		30		30
	psi	435		435		435
Flow rate at 6 bar (0.6 MPa - 87 psi) ΔP 1 bar (0.1 MPa - 14 psi)	Nl/min	480		750	1450	1750
Maximum temperature	°C	80		80		80
	°F	176		176		176

### QUICK-FIT PORT, MALE



Code	Ref.	Mod.	Thread	Quantity
0101001	01	mini	1/8	50
0101002	02	mini	1/4	50
0201101	101	100	1/4	25
0301201	201	200	3/8	25
0300202	201/A	200	1/4	25
0401301	301	300	1/2	10

### QUICK-FIT COUPLING, MALE



Code	Ref.	Mod.	Thread	Quantity
0102011	11	mini	1/8	50
0102012	12	mini	1/4	50
0202111	111	100	1/4	25
0302211	211	200	3/8	25
0303205	211/A	200	1/4	25
0402311	311	300	1/2	20

### NYLON PIPE FITTING WITH SPRING

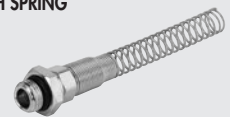

Code	Ref.	Thread	Ø FOR:	Quantity
0010001	C1/Z	1/4	8/6	25
0010002	C1/Z	3/8	8/6	25
0010003	C1/Z	1/4	10/8	25
0010004	C1/Z	3/8	10/8	25
0010005	C1/Z	3/8	12/10	20

### QUICK-FIT PORT, FEMALE



Code	Ref.	Mod.	Thread	Quantity
0101003	03	mini	1/8	50
0101004	04	mini	1/4	50
0201102	102	100	1/4	25
0301202	202	200	3/8	25
0401302	302	300	1/2	10

### QUICK-FIT COUPLING, FEMALE



Code	Ref.	Mod.	Thread	Quantity
0102013	13	mini	1/8	50
0102014	14	mini	1/4	50
0202112	112	100	1/4	25
0302212	212	200	3/8	25
0402312	312	300	1/2	20

### HOSE FITTING



Code	Ref.	Thread	Ø FOR:	Quantity
2601001	40	1/4	6X14	25
2601002	41	1/4	8X17	25
2601003	42	1/4	10X19	25
2601004	43	1/2	13X23	25

### QUICK-FIT PORT, NYLON PIPE



Code	Ref.	Mod.	Ø FOR:	Quantity
0101005	05	mini	6/4	50
0101006	06	mini	8/6	50

### QUICK-FIT COUPLING, NYLON PIPE



Code	Ref.	Mod.	Ø FOR:	Quantity
0102015	15	mini	6/4	50
0102016	16	mini	8/6	50

### SWIVEL NYLON PIPE FITTING WITH SPRING



Code	Ref.	Thread	Ø FOR:	Quantity
2501010	50	1/4	6/4	50
2501011	51	1/4	8/6	50
2501012	52	3/8	10/8	25
2501013	53	3/8	12/10	20

### QUICK-FIT PORT, NYLON PIPE WITH SPRING



Code	Ref.	Mod.	Ø FOR:	Quantity
0101007	07	mini	6/4	20
0101008	08	mini	8/6	20

### QUICK-FIT COUPLING, NYLON PIPE WITH SPRING

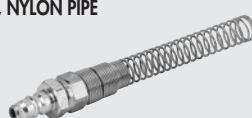

Code	Ref.	Mod.	Ø FOR:	Quantity
0102017	17	mini	6/4	50
0102018	18	mini	8/6	50

## QUICK-FIT COUPLINGS FOR MOULD CONDITIONING SERIES ICS

TECHNICAL DATA		501 V with valve	401 V with valve	503 V without valve	403 V without valve
Threaded coupling		1/8"	1/4"	1/8"	1/4"
Maximum temperature at: 1.8 MPa; 18 bar; 261 psi	°F			+248	
	°C			+120	
Minimum temperature at: 1.8 MPa; 18 bar; 261 psi	°F			-68	
	°C			-20	
Maximum pressure	MPa			1.8	
	bar			18	
	psi			261	
Type of gasket				FKM/FPM	

### FEMALE PORT



Code	Ref.	Thread	Safety valve	Quantity
0601040	501V	1/8	yes	10
0501040	401V	1/4	yes	25
0600040	503V	1/8	no	10
0500040	403V	1/4	no	25

### MALE COUPLING



Code	Ref.	Thread	Quantity
0602001	511	1/8	50
0502001	411	1/4	100

### FEMALE COUPLING



Code	Ref.	Thread	Quantity
0602002	512	1/8	50
0502002	412	1/4	100

## FLOW MICRO-REGULATOR SERIES MRF COMPACT N AND O

TECHNICAL DATA METRIC or G (BSP)		M5			G1/8				G1/4				G3/8			G1/2
Pipe		Ø 4	Ø 5*	Ø 6	Ø 4	Ø 5*	Ø 6	Ø 8	Ø 6	Ø 8	Ø 10	Ø 12	Ø 8	Ø 10	Ø 12	Ø 12
Max input pressure	MPa	1														
	bar	10														
	psi	145														
Temperature range: Technopolymer ring	°C	- 10 to + 50														
	°F	+ 14 to + 122														
Brass ring	°C	- 10 to + 70														
	°F	+ 14 to + 158														
Max flow rate on regulation at 6.3 bar	Nl/min	150	155	155	350	360	380	400	750	850	950	1000	1250	1300	1400	2000
Max flow rate on exhaust at 6.3 bar with closed needle	Nl/min	140	145	150	300	320	350	390	450	500	550	1030	1050	1250	1750	
Max flow rate on exhaust at 6.3 bar with open needle	Nl/min	240	245	245	450	510	600	650	850	1050	1150	1250	1700	1700	2100	2700
Regulation		Manual (COMPACT N only) or using a screwdriver														
Internal system		Tapered needle														
Fluid		Filtered, lubricated or unlubricated compressed air														
* Pipe Ø 5 is only available with a brass ring																

TECHNICAL DATA UNF or NPT		10-32 UNF			1/8 NPT				1/4 NPT				3/8 NPT		1/2 NPT
Pipe		Ø 5/32	Ø 1/4	Ø 5/32	Ø 1/4	Ø 5/16	Ø 3/8	Ø 1/4	Ø 5/16	Ø 3/8	Ø 1/2	Ø 3/8	Ø 1/2	Ø 1/2	
Max input pressure	MPa	1													
	bar	10													
	psi	145													
Temperature range: Brass ring	°C	- 10 to + 70													
	°F	+ 14 to + 158													
Max flow rate on regulation at 6.3 bar	Nl/min	150	155	350	380	400	400	750	850	950	1000	1300	1400	2000	
Max flow rate on exhaust at 6.3 bar with closed needle	Nl/min	140	150	300	350	390	390	450	275	500	550	1050	1250	1750	
Max flow rate on exhaust at 6.3 bar with open needle	Nl/min	240	245	450	600	650	650	850	1050	1150	1250	1700	2100	2700	
Regulation		Manual or using a screwdriver													
Internal system		Tapered needle													
Fluid		Filtered, lubricated or unlubricated compressed air													

### SYNOPTIC, SIZES AND VERSIONS

M R F FAMILY	N TYPE	M RING	C FUNCTION	4 Ø TUBE / THREAD	M5 THREAD
Flow microregulator	N	Nickel-plated brass with push-in fitting	C For cylinder V For valve B Bidirectional	MILLIMETER TUBE 4 Ø 4 (5/32") 5 Ø 5 6 Ø 6 8 Ø 8 (5/16") 10 Ø 10 12 Ø 12	M5 M5 1/8 G1/8 1/4 G1/4 3/8 G3/8 1/2 G1/2
	O				
		T Technopolymer with push-in fitting		G (BSP) THREAD 1/8 G1/8 Female 1/4 G1/4 Female 3/8 G3/8 Female	
		F Nickel-plated brass with female thread		INCH TUBES ▲ 1/4 Ø 1/4" 3/8 Ø 3/8" 1/2 Ø 1/2"	

▲ Available only for version MRF compact "N" with brass ring.

**MRF COMPACT "O"  
BRASS RING**



Code	Description	Quantity
9001001C	MRF O M C 4 M5	10
9001110V	MRF O M V 4 M5	10
9001601B	MRF O M B 4 M5	10
9001002C	MRF O M C 5 M5	10
9001113V	MRF O M V 5 M5	10
9001603B	MRF O M B 5 M5	10
9001007C	MRF O M C 6 M5	10
9001105V	MRF O M V 6 M5	10
9001612B	MRF O M B 6 M5	10
9001011C	MRF O M C 4 1/8	10
9001111V	MRF O M V 4 1/8	10
9001602B	MRF O M B 4 1/8	10
9001012C	MRF O M C 5 1/8	10
9001112V	MRF O M V 5 1/8	10
9001604B	MRF O M B 5 1/8	10
9001003C	MRF O M C 6 1/8	10
9001101V	MRF O M V 6 1/8	10
9001605B	MRF O M B 6 1/8	10
9001005C	MRF O M C 8 1/8	10
9001103V	MRF O M V 8 1/8	10
9001607B	MRF O M B 8 1/8	10
9001004C	MRF O M C 6 1/4	10
9001102V	MRF O M V 6 1/4	10
9001606B	MRF O M B 6 1/4	10
9001006C	MRF O M C 8 1/4	10
9001104V	MRF O M V 8 1/4	10
9001608B	MRF O M B 8 1/4	10
9001008C	MRF O M C 10 1/4	10
9001106V	MRF O M V 10 1/4	10
9001609B	MRF O M B 10 1/4	10
9001014C	MRF O M C 12 1/4	10
9001123V	MRF O M V 12 1/4	10
9001623B	MRF O M B 12 1/4	10
9001010C	MRF O M C 8 3/8	10
9001115V	MRF O M V 8 3/8	10
9001611B	MRF O M B 8 3/8	10
9001009C	MRF O M C 10 3/8	10
9001114V	MRF O M V 10 3/8	10
9001610B	MRF O M B 10 3/8	10
9001015C	MRF O M C 12 3/8	10
9001124V	MRF O M V 12 3/8	10
9001624B	MRF O M B 12 3/8	10
9001016C	MRF O M C 12 1/2	10
9001125V	MRF O M V 12 1/2	10
9001625B	MRF O M B 12 1/2	10

**MRF COMPACT "O"  
TECHNOPOLYMER RING**



Code	Description	Quantity
9011001C	MRF O T C 4 M5	10
9011110V	MRF O T V 4 M5	10
9011601B	MRF O T B 4 M5	10
9011007C	MRF O T C 6 M5	10
9011105V	MRF O T V 6 M5	10
9011612B	MRF O T B 6 M5	10
9011011C	MRF O T C 4 1/8	10
9011111V	MRF O T V 4 1/8	10
9011602B	MRF O T B 4 1/8	10
9011003C	MRF O T C 6 1/8	10
9011101V	MRF O T V 6 1/8	10
9011605B	MRF O T B 6 1/8	10
9011005C	MRF O T C 8 1/8	10
9011103V	MRF O T V 8 1/8	10
9011607B	MRF O T B 8 1/8	10
9011004C	MRF O T C 6 1/4	10
9011102V	MRF O T V 6 1/4	10
9011606B	MRF O T B 6 1/4	10
9011006C	MRF O T C 8 1/4	10
9011104V	MRF O T V 8 1/4	10
9011608B	MRF O T B 8 1/4	10
9011008C	MRF O T C 10 1/4	10
9011106V	MRF O T V 10 1/4	10
9011609B	MRF O T B 10 1/4	10
9011014C	MRF O T C 12 1/4	10
9011123V	MRF O T V 12 1/4	10
9011623B	MRF O T B 12 1/4	10
9011009C	MRF O T C 10 3/8	10
9011114V	MRF O T V 10 3/8	10
9011610B	MRF O T B 10 3/8	10
9011015C	MRF O T C 12 3/8	10
9011124V	MRF O T V 12 3/8	10
9011624B	MRF O T B 12 3/8	10
9011016C	MRF O T C 12 1/2	10
9011125V	MRF O T V 12 1/2	10
9011625B	MRF O T B 12 1/2	10

9031106V	MRF N M V 6 1/8	10
9031206B	MRF N M B 6 1/8	10
9031008C	MRF N M C 8 1/8	10
9031108V	MRF N M V 8 1/8	10
9031208B	MRF N M B 8 1/8	10
9031007C	MRF N M C 6 1/4	10
9031107V	MRF N M V 6 1/4	10
9031207B	MRF N M B 6 1/4	10
9031009C	MRF N M C 8 1/4	10
9031109V	MRF N M V 8 1/4	10
9031209B	MRF N M B 8 1/4	10
9031010C	MRF N M C 8 3/8	10
9031110V	MRF N M V 8 3/8	10
9031210B	MRF N M B 8 3/8	10
9031011C	MRF N M C 10 1/4	10
9031111V	MRF N M V 10 1/4	10
9031211B	MRF N M B 10 1/4	10
9031012C	MRF N M C 10 3/8	10
9031112V	MRF N M V 10 3/8	10
9031212B	MRF N M B 10 3/8	10
9031014C	MRF N M C 12 1/4	10
9031114V	MRF N M V 12 1/4	10
9031214B	MRF N M B 12 1/4	10
9031015C	MRF N M C 12 3/8	10
9031115V	MRF N M V 12 3/8	10
9031215B	MRF N M B 12 3/8	10
9031016C	MRF N M C 12 1/2	10
9031116V	MRF N M V 12 1/2	10
9031216B	MRF N M B 12 1/2	10

**MRF COMPACT "N" BRASS RING -  
INCH TUBES AND UNF  
or NPT THREAD**

UNF  
NPT



Code	Description	Quantity
9U31001C	MRF N M C 5/32 10-32 UNF	10
9U31101V	MRF N M V 5/32 10-32 UNF	10
9U31201B	MRF N M B 5/32 10-32 UNF	10
9U31005C	MRF N M C 1/4 10-32 UNF	10
9U31105V	MRF N M V 1/4 10-32 UNF	10
9U31205B	MRF N M B 1/4 10-32 UNF	10
9U31002C	MRF N M C 5/32 1/8 NPT	10
9U31102V	MRF N M V 5/32 1/8 NPT	10
9U31202B	MRF N M B 5/32 1/8 NPT	10
9U31006C	MRF N M C 1/4 1/8 NPT	10
9U31106V	MRF N M V 1/4 1/8 NPT	10
9U31206B	MRF N M B 1/4 1/8 NPT	10
9U31008C	MRF N M C 5/16 1/8 NPT	10
9U31108V	MRF N M V 5/16 1/8 NPT	10
9U31208B	MRF N M B 5/16 1/8 NPT	10
9U31010C	MRF N M C 3/8 1/8 NPT	10
9U31110V	MRF N M V 3/8 1/8 NPT	10
9U31210B	MRF N M B 3/8 1/8 NPT	10
9U31007C	MRF N M C 1/4 1/4 NPT	10
9U31107V	MRF N M V 1/4 1/4 NPT	10
9U31207B	MRF N M B 1/4 1/4 NPT	10
9U31009C	MRF N M C 5/16 1/4 NPT	10
9U31109V	MRF N M V 5/16 1/4 NPT	10
9U31209B	MRF N M B 5/16 1/4 NPT	10
9U31011C	MRF N M C 3/8 1/4 NPT	10
9U31111V	MRF N M V 3/8 1/4 NPT	10
9U31211B	MRF N M B 3/8 1/4 NPT	10
9U31014C	MRF N M C 1/2 1/4 NPT	10
9U31114V	MRF N M V 1/2 1/4 NPT	10
9U31214B	MRF N M B 1/2 1/4 NPT	10
9U31012C	MRF N M C 3/8 3/8 NPT	10
9U31112V	MRF N M V 3/8 3/8 NPT	10
9U31212B	MRF N M B 3/8 3/8 NPT	10
9U31015C	MRF N M C 1/2 3/8 NPT	10
9U31115V	MRF N M V 1/2 3/8 NPT	10
9U31215B	MRF N M B 1/2 3/8 NPT	10
9U31016C	MRF N M C 1/2 1/2 NPT	10
9U31116V	MRF N M V 1/2 1/2 NPT	10
9U31216B	MRF N M B 1/2 1/2 NPT	10

**SPARE PARTS**

**ANTI-TAMPERING CAP**



Code	Description
9090001	Cap MRF O M5
9090002	Cap MRF O 1/8-1/4
9090003	Cap MRF O 3/8-1/2

**MRF COMPACT "O"  
THREADED BRASS RING**



Code	Description	Quantity
9001020C	MRF O F C 1/8 1/8	10
9001120V	MRF O F V 1/8 1/8	10
9001620B	MRF O F B 1/8 1/8	10
9001021C	MRF O F C 1/4 1/4	10
9001121V	MRF O F V 1/4 1/4	10
9001621B	MRF O F B 1/4 1/4	10
9001022C	MRF O F C 3/8 3/8	10
9001122V	MRF O F V 3/8 3/8	10
9001622B	MRF O F B 3/8 3/8	10

**MRF COMPACT "N"  
BRASS RING**



Code	Description	Quantity
9031001C	MRF N M C 4 M5	10
9031101V	MRF N M V 4 M5	10
9031201B	MRF N M B 4 M5	10
9031003C	MRF N M C 5 M5	10
9031103V	MRF N M V 5 M5	10
9031203B	MRF N M B 5 M5	10
9031005C	MRF N M C 6 M5	10
9031105V	MRF N M V 6 M5	10
9031205B	MRF N M B 6 M5	10
9031002C	MRF N M C 4 1/8	10
9031102V	MRF N M V 4 1/8	10
9031202B	MRF N M B 4 1/8	10
9031004C	MRF N M C 5 1/8	10
9031104V	MRF N M V 5 1/8	10
9031204B	MRF N M B 5 1/8	10
9031006C	MRF N M C 6 1/8	10

**MRF COMPACT "N" TECHNOPOLYMER RING**

Code	Description	Quantity
9021001C	MRF N T C 4 M5	10
9021101V	MRF N T V 4 M5	10
9021201B	MRF N T B 4 M5	10
9021005C	MRF N T C 6 M5	10
9021105V	MRF N T V 6 M5	10
9021205B	MRF N T B 6 M5	10
9021002C	MRF N T C 4 1/8	10
9021102V	MRF N T V 4 1/8	10
9021202B	MRF N T B 4 1/8	10
9021006C	MRF N T C 6 1/8	10
9021106V	MRF N T V 6 1/8	10
9021206B	MRF N T B 6 1/8	10
9021007C	MRF N T C 6 1/4	10
9021107V	MRF N T V 6 1/4	10
9021207B	MRF N T B 6 1/4	10
9021008C	MRF N T C 8 1/8	10
9021108V	MRF N T V 8 1/8	10
9021208B	MRF N T B 8 1/8	10

9021009C	MRF N T C 8 1/4	10
9021109V	MRF N T V 8 1/4	10
9021209B	MRF N T B 8 1/4	10
9021011C	MRF N T C 10 1/4	10
9021111V	MRF N T V 10 1/4	10
9021211B	MRF N T B 10 1/4	10
9021012C	MRF N T C 10 3/8	10
9021112V	MRF N T V 10 3/8	10
9021212B	MRF N T B 10 3/8	10
9021014C	MRF N T C 12 1/4	10
9021114V	MRF N T V 12 1/4	10
9021214B	MRF N T B 12 1/4	10
9021015C	MRF N T C 12 3/8	10
9021115V	MRF N T V 12 3/8	10
9021215B	MRF N T B 12 3/8	10
9021016C	MRF N T C 12 1/2	10
9021116V	MRF N T V 12 1/2	10
9021216B	MRF N T B 12 1/2	10

**MRF COMPACT "N" THREADED BRASS RING**

Code	Description	Quantity
9031301C	MRF N F C 1/8 1/8	10
9031401V	MRF N F V 1/8 1/8	10
9031501B	MRF N F B 1/8 1/8	10
9031302C	MRF N F C 1/4 1/4	10
9031402V	MRF N F V 1/4 1/4	10
9031502B	MRF N F B 1/4 1/4	10
9031303C	MRF N F C 3/8 3/8	10
9031403V	MRF N F V 3/8 3/8	10
9031503B	MRF N F B 3/8 3/8	10

**FLOW MICRO-REGULATOR SERIES MRF HIGH-FLOW**

TECHNICAL DATA	1/8			1/4			
	Ø 4	Ø 6	Ø 8	Ø 6	Ø 8	Ø 10	Ø 12
Pipe							
Max input pressure				1 10 145			
Temperature range: technopolymer ring				- 10 to + 50 + 14 to + 122			
Max flow rate on regulation at 6.3 bar	500	600	650	850	900	1150	1200
Max flow rate on exhaust at 6.3 bar with closed needle	400	500	600	700	850	875	950
Max flow rate on exhaust at 6.3 bar with open needle	500	750	900	1000	1250	1350	1450
Regulation	Manual or via screwdriver						
Internal system	Tapered needle						
Fluid	Filtered, lubricated or unlubricated compressed air						

**SYNOPTIC, SIZES AND VERSIONS**

M R F ELEMENT	N TYPE	T RING	C FUNCTION	4 Ø PIPE	1/8 Ø THREAD
	H High flo	T Technopolymer with push-in fitting	C For cylinder V For valve B Bidirectional	4: Ø 4 6: Ø 6 8: Ø 8 10: Ø 10 12: Ø 12	1/8: 1/8 1/4: 1/4

Code	Description	Quantity	Code	Description	Quantity	Code	Description	Quantity
9025002C	MRF H T C 4 1/8	10	9025107V	MRF H T V 6 1/4	10	9025609B	MRF H T B 8 1/4	10
9025102V	MRF H T V 4 1/8	10	9025607B	MRF H T B 6 1/4	10	9025011C	MRF H T C 10 1/4	10
9025602B	MRF H T B 4 1/8	10	9025008C	MRF H T C 8 1/8	10	9025111V	MRF H T V 10 1/4	10
9025006C	MRF H T C 6 1/8	10	9025108V	MRF H T V 8 1/8	10	9025611B	MRF H T B 10 1/4	10
9025106V	MRF H T V 6 1/8	10	9025608B	MRF H T B 8 1/8	10	9025014C	MRF H T C 12 1/4	10
9025606B	MRF H T B 6 1/8	10	9025009C	MRF H T C 8 1/4	10	9025114V	MRF H T V 12 1/4	10
9025007C	MRF H T C 6 1/4	10	9025109V	MRF H T V 8 1/4	10	9025614B	MRF H T B 12 1/4	10



## FLOW MICRO-REGULATOR SERIE MRF PUSH-LOCK



TECHNICAL DATA	1/8			1/4			
	Ø 4	Ø 6	Ø 8	Ø 6	Ø 8	Ø 10	Ø 12
Pipe							
Max. input pressure				1	10		
				145			
Temperature range: technopolymer ring				- 10 to + 50			
				+ 14 to + 122			
Max. flow rate on regulation at 6.3 bar	350	380	400	750	850	950	1000
Max. flow rate on exhaust at 6.3 with closed needle	300	350	390	450	475	500	550
Max. flow rate on exhaust at 6.3 with open needle	450	600	650	850	1050	1150	1250
Regulation	Manual with Push-Lock knob						
Internal system	Tapered needle						
Fluid	Filtered, lubricated or unlubricated compressed air						

### SYNOPTIC, SIZES AND VERSIONS

M R F ELEMENT	P TYPE	T RING	C RING	4 Ø PIPE	1/8 Ø THREAD
	P Push-lock	T Technopolymer with push-in fitting	C For cylinder V For valve B Bidirectional	4: Ø 4 6: Ø 6 8: Ø 8 10: Ø 10 12: Ø 12	1/8: 1/8 1/4: 1/4

Code	Description	Quantity	Code	Description	Quantity	Code	Description	Quantity
9026002C	MRF P T C 4 1/8	10	9026108V	MRF P T V 8 1/8	10	9026609B	MRF P T B 8 1/4	10
9026102V	MRF P T V 4 1/8	10	9026608B	MRF P T B 8 1/8	10	9026011C	MRF P T C 10 1/4	10
9026602B	MRF P T B 4 1/8	10	9026007C	MRF P T C 6 1/4	10	9026111V	MRF P T V 10 1/4	10
9026006C	MRF P T C 6 1/8	10	9026107V	MRF P T V 6 1/4	10	9026611B	MRF P T B 10 1/4	10
9026106V	MRF P T V 6 1/8	10	9026607B	MRF P T B 6 1/4	10	9026014C	MRF P T C 12 1/4	10
9026606B	MRF P T B 6 1/8	10	9026009C	MRF P T C 8 1/4	10	9026114V	MRF P T V 12 1/4	10
9026008C	MRF P T C 8 1/8	10	9026109V	MRF P T V 8 1/4	10	9026614B	MRF P T B 12 1/4	10

## SPARE PARTS

### ANTI-TAMPERING KNOB



Code	Description
9200703	Anti-tampering knob

## IN-LINE FLOW REGULATOR SERIES RFL



### RFL U (UNIDIRECTIONAL)



Code	Ref.	Quantity
9041001	RFL U M5	10
9041002	RFL U 1/8	10
9041003	RFL U 1/4	10
9041004	RFL U 3/8	5
9041005	RFL U 1/2	5

### RFL B (BIDIRECTIONAL)



Code	Ref.	Quantity
9041201	RFL B M5	10
9041202	RFL B 1/8	10
9041203	RFL B 1/4	10
9041204	RFL B 3/8	5
9041205	RFL B 1/2	5

## QUICK EXHAUST VALVES SERIES VSR



New, more compact and lighter version. Used to evacuate air in the cylinder quickly, which increases cylinder speed.

- Temperature 0-80°C (32°-176°F)
- Max. pressure 12 bar (1200 kPa)
- Min. pressure 0.5 bar (50 kPa)

### Nominal flow rate (P → A) ΔP = 1 bar [NI/min]:

Pm [bar]	1/8	1/4	1/2
2.5	550	800	2400
4	700	1200	2800
6.3	900	1400	3600

### ORDERING CODES

Code	Ref.	Quantity
9101201	VSR 1/8	20
9201201	VSR 1/4	10
9401201	VSR 1/2	5



### Empty flow rate (A → R) [NI/min]:

Pm [bar]	1/8	1/4	1/2
2.5	800	1500	4400
4	1200	2450	6300
6.3	1800	3500	8000

### SPARE GASKETS

Code	Ref.	Quantity
9151501	Spare gaskets VSR 1/8	10
9251501	Spare gaskets VSR 1/4	10
9451501	Spare gaskets VSR 1/2	10

## STOP VALVES SERIES STP



TECHNICAL DATA	UNIDIRECTIONAL				BIDIRECTIONAL								
	1/8"	1/4"	3/8"	1/2"	1/8"	1/4"	3/8"	1/2"	3/4"				
Operating pressure	bar				0.5 to 10								
	MPa				0.05 to 1								
Operating temperature	°C				-10 to 60								
	°F				14 to 148								
Fluid	Lubricated or unlubricated filtered air												
Flow rate (6 bar)	NI/min				250	350	950	1450	320	700	1200	2100	7000
Connection type	Female threaded - R automatic cartridge												
Installation	In any position												

### BIDIRECTIONAL THREADED STOP VALVE

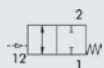

Code	Description	Quantity
W6001101001	STP-B 1/8 108	10
W6001111011	STP-B 1/4 104	10
W6001121021	STP-B 3/8 138	10
W6001131031	STP-B 1/2 112	1
W6001141041	STP-B 3/4 134	1

### PIPE BIDIRECTIONAL STOP VALVE

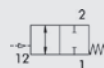

Code	Description	Quantity
W6001101106	STP-B 1/8 006	10
W6001111106	STP-B 1/4 006	10
W6001111108	STP-B 1/4 008	10
W6001121108	STP-B 3/8 008	10
W6001121110	STP-B 3/8 010	10
W6001131112	STP-B 1/2 012	10

### UNIDIRECTIONAL PIPE STOP VALVE

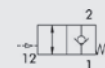

Code	Description	Quantity
W6001001106	STP-U 1/8 006	10
W6001011106	STP-U 1/4 006	10
W6001011108	STP-U 1/4 008	10
W6001021108	STP-U 3/8 008	10
W6001021110	STP-U 3/8 010	10
W6001031112	STP-U 1/2 012	10

### THREAD + PIPE BIDIRECTIONAL STOP VALVE

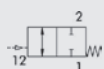

Code	Description	Quantity
W6001101002	STP-BX 1/8-1/8 04	10
W6001111012	STP-BX 1/4-1/4 04	10
W6001121022	STP-BX 3/8-3/8 04	10

### UNIDIRECTIONAL THREADED STOP VALVE

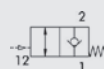

Code	Description	Quantity
W6001001001	STP-U 1/8 108	10
W6001011011	STP-U 1/4 114	10
W6001021021	STP-U 3/8 138	10

## SLIDE VALVES SERIES VCS



TECHNICAL DATA		1/8"	1/4"	3/8"	1/2"
Operating pressure		0 - 10 bar (0 - 1 MPa)			
Operating temperature range	°C	-10 to + 80			
Fluid		Lubricated or unlubricated filtered air			
Flow rate at 6.3 bar (0.63 Mpa - 91 psi) ΔP 0.5 bar	Nl/min	430	680	1400	2200
Flow rate at 6.3 bar (0.63 Mpa - 91 psi) ΔP 1 bar	Nl/min	630	1040	2070	3330
Conductance C	Nl/min · bar	170	247	537	833
Critical ratio b	bar/bar	0.2	0.3	0.1	0.2

Code	Description	Quantity		
W0970050001	Slide valves 3/2 1/8"	10		
W0970050002	Slide valves 3/2 1/4"	10		
W0970050003	Slide valves 3/2 3/8"	10		
W0970050004	Slide valves 3/2 1/2"	10		

## CIRCUIT SELECTOR VALVES SERIES VOR



TECHNICAL DATA		1/8"	1/4"
Nominal flow rate at 6.3 bar ΔP 1 bar	Nl/min	500	1300
Operating temperature range	°C	-10 to + 80	
	°F	14 to 176	
Operating pressure	bar	2 - 10	
	MPa	0.2 - 1	
Fluid		Lubricated or unlubricated filtered air	

Code	Description	Quantity		
W3603000001	VOR 1/8	10		
W3603000002	VOR 1/4	5		

## CHECK VALVE SERIES VNR



TECHNICAL DATA		1/8"	1/4"
Ports		1/8"	1/4"
Nominal diameter	mm	5.2	7
Nominal flow rate	Nl/min	900	1100
Operating temperature range	°C	-10 to + 70	
	°F	14 to 158	
Operating pressure	bar	2 - 10	
	MPa	0.2 - 1	
Opening pressure	bar	0.05 (5 KPa)	
Fluid		Lubricated or unlubricated filtered air	



Code	Description	Quantity		
W3601000001	VNR 1/8	10		
W3601000002	VNR 1/4	10		

## PNEUMATIC LOGIC



TECHNICAL DATA	
Operating temperature	°C
Valve fitting	
Pressure range	bar
Nominal diameter	mm
Flow rate at 6 bar (0.6 MPa-87 psi) ΔP 1 bar (0.1 Mpa-14.5 psi)	Nl/min
Fluid	
Recommended lubricant	
Actionament	
Reset	
Installation	
Mounted	
MATERIALS	
Body	
Spool	
Seal	

- 10 to + 60
Push-in fitting for Ø 4 pipe
OR - AND: from 1.5 to 8 bar
YES-NOT -MEMORY: from 0 to 8 bar, pilot pressure from 1.5 to 8 bar
NOT: 6 bar switching threshold = 0.4
2.7
100
Lubricated or unlubricated filtered compressed air; must be uninterrupted when lubricated
ISO e UNI FD22
Via compressed air
AND-OR: via compressed air
YES-NOT via mechanical spring
MEMORY: via compressed air
In any position
On Omega bar (DIN EN 50022) size 35 x 7 or 35 x 15
Wall-mounted with Ø 4.2 holes
Technopolymer
Aluminium
NBR

### LOGIC ELEMENT: OR



Code	Descr.	Quantity
W360400001	OR	10

### LOGIC ELEMENT: AND



Code	Descr.	Quantity
W360400002	AND	10

### LOGIC ELEMENT: NOT

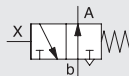

Code	Descr.	Quantity
W360400003	NOT	10

### LOGIC ELEMENT: YES

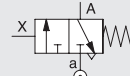

Code	Descr.	Quantity
W360400004	YES	10

### LOGIC ELEMENT: MEMORY

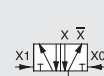

Code	Descr.	Quantity
W360400005	Memory	10

## TIMER

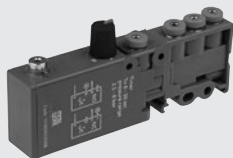

TECHNICAL DATA	
Temperature range	°C
Valve coupling	mm
Pressure range	bar
Nominal diameter	mm
Flow rate at 6 bar (0.6 MPa, 87 psi) ΔP 1 bar (0.1 Mpa, 14.5 psi)	Nl/min
Delay setting range	s
Signal shutoff time	s
Repeatability	s
Fluid	
Operating	
Repositioning	
Installation	
Assembly	
MATERIALS	
Body	
Internal parts	
Gaskets	
Spring	

- 10 to + 60
Push-in fitting for Ø 4 pipe
From 2.5 to 8
2.7
100
From 0 to 30, at 6 bar
< 0.1
± 0.4
Filtered, lubricated or unlubricated compressed air. If used, must be continuous
By compressed air
By mechanical spring
In any direction
On Ω bar (DIN EN 50022) size 35 x 7 or 35 x 15 - Wall mounting using Ø 4.2 holes
Anodised aluminium / Technopolymer
Brass / Technopolymer
NBR
Spring steel

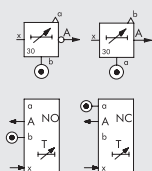

Code	Description
W360400006	Timer

## AIR-AIR PRESSURE MULTIPLIER (BOOSTER)



TECHNICAL DATA	Booster Ø 40	Booster Ø 40 with regulator	Booster Ø 63	Booster Ø 63 with regulator
Bore	Ø 40		Ø 63	
Fluid	Filtered unlubricated compressed air, Lubrication, if used, must be continuous.			
Threaded port	1/8"		3/8"	
Inlet pressure	MPa		0.2 - 1	
	bar		2 - 10	
	psi		29 - 145	
Outlet pressure	max 2	max 1.6 (regulated)	max 2	max 1.6 (regulated)
	max 20	max 16 (regulated)	max 20	max 16 (regulated)
	max 290	max 232 (regulated)	max 290	max 232 (regulated)
Operating temperature	-10 to +60	-10 to +60	-10 to +60	-10 to +60
	°C	°C	°C	°C
	14 to 140	14 to 122	14 to 140	14 to 140
	°F	°F	°F	°F
Weight	1.380	1.600	4.240	5.350
Mounting	Wall or panel			
Installation	In any position			

### PRESSURE MULTIPLIER (BOOSTER)



Code	Description
9002100	Booster Ø 40
9002300	Booster Ø 63

### PRESSURE MULTIPLIER (BOOSTER WITH REGULATOR)

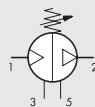

Code	Description
9002200	Booster Ø 40 with regulator
9002600	Booster Ø 63 with regulator

## ACCESSORIES

### REGULATOR UNIT

Code	Description
9002380	Ø 63 regulator unit
9002180	Ø 40 regulator unit

### PRESSURE GAUGE

Code	Description
9700101	M 40 1/8 012
9700110	M 40x40 1/8 012

### SILENCER

Code	Thread	
W0970530072	G1/8	For Ø 40
W0970530014	G3/8	For Ø 63

## SPARE PARTS

### SET OF GASKETS

Code	Description
9002190	Set of gaskets for Ø 40 Booster
9002390	Set of gaskets for Ø 63 Booster

## IN-LINE PROGRESSIVE STARTER VAP 1/4" AND 1/2"



TECHNICAL DATA	VAP 1/4"	VAP 1/2"
Threaded ports	1/4"	1/2"
Type of valve	2/2 NC	
Minimum operating pressure	bar	
	2	
	psi	
	29	
	Mpa	
	0.2	
Maximum operating pressure	bar	
	10	
	psi	
	145	
	Mpa	
	1	
Switching pressure	About 60% of inlet pressure	
Operating frequency	max 5	
Flow rate at 6.3 bar, ΔP=0.5 bar	Nl/min	2350
	scfm	83
Flow rate at 6.3 bar, ΔP=1 bar	Nl/min	3100
	scfm	110
Maximum flow rate through flow regulator at 6.3 bar	Nl/min	300
	scfm	11
Operating temperature	°C	
	from -10 to 70	
	°F	
	from 14 to 158	
Fluid	Filtered, lubricated or unlubricated, compressed air. Lubrication, if used, must be continuous.	
Weight	90	220
Wall fixing screws	Min. M4x25	Min. M4x35
Mounting	In any position	

Code	Description
W3606000002	VAP 1/4
W3606000004	VAP 1/2

## DISTRIBUTION FRAMES AND ROTARY JOINTS



TECHNICAL DATA		1/8"	1/4"	3/8"	1/2"
Threaded ports					
Max pressure	bar			0 - 12	
	MPa			0 - 1.2	
Operating temperature	°C			- 10 to + 80	
Fluid				Lubricated or unlubricated filtered air	
Body				Rotary joints: Nickel-plated brass	
Gaskets				Distribution frame: Anodised aluminium	
				NBR	

### 4-WAY DISTRIBUTION FRAME



Code	Thread
W0501101001	1/8
W0501111002	1/4
W0501121003	3/8
W0501131004	1/2

### DISTRIBUTION FRAME WITH 2 STRAIGHT 1/8" OUTLETS



Code	INLETS		OUTLETS	
	N°	Thread	N°	Thread
W0502111001	2	1/4	2	1/8
W0502121002	2	3/8	2	1/4
W0502131002	2	1/2	2	1/4

### DISTRIBUTION FRAME WITH MULTIPLE STRAIGHT 1/4" OUTLETS



Code	INLETS		OUTLETS	
	N°	Thread	N°	Thread
W0502121006	2	3/8	3	1/4
W0502121008	2	3/8	4	1/4
W0502121010	2	3/8	5	1/4
W0502121012	2	3/8	6	1/4
W0502131006	2	1/2	3	1/4
W0502131008	2	1/2	4	1/4
W0502131010	2	1/2	5	1/4
W0502131012	2	1/2	6	1/4

### DISTRIBUTION FRAME WITH MULTIPLE STRAIGHT 1/8" OUTLETS



Code	INLETS		OUTLETS	
	N°	Thread	N°	Thread
W0502111005	2	1/4	3	1/8
W0502111007	2	1/4	4	1/8
W0502111009	2	1/4	5	1/8
W0502111011	2	1/4	6	1/8

### DISTRIBUTION FRAME WITH 2 OPPOSED OUTLETS



Code	INLETS		OUTLETS	
	N°	Thread	N°	Thread
W0503111013	2	1/4	2+2	1/8
W0503121014	2	3/8	2+2	1/4
W0503131014	2	1/2	2+2	1/4

### DISTRIBUTION FRAME WITH 1/8"-1/4" OPPOSED OUTLETS



Code	INLETS		OUTLETS	
	N°	Thread	N°	Thread
W0503111015	2	1/4	3+3	1/8
W0503111017	2	1/4	4+4	1/8
W0503111019	2	1/4	5+5	1/8
W0503121016	2	3/8	3+3	1/4
W0503121018	2	3/8	4+4	1/4
W0503121020	2	3/8	5+5	1/4
W0503131016	2	1/2	3+3	1/4
W0503131018	2	1/2	4+4	1/4
W0503131020	2	1/2	5+5	1/4

### DISTRIBUTOR, Ø 4-6-8 mm



Code	N. positions	OUTLETS
7304106	6 X Ø 4	2 X 1/8
7304112	12 X Ø 4	2 X 1/8
7306206	6 X Ø 6	2 X 1/4
7306212	12 X Ø 6	2 X 1/4
7308306	6 X Ø 8	2 X 3/8
7308312	12 X Ø 8	2 X 3/8

### SINGLE ROTARY JOINT



Code	Thread
W0511101101	1/8
W0511121121	1/4
W0511131131	3/8
W0511141141	1/2
W0511151151	3/4
W0511161161	1

### MULTIPLE ROTARY JOINT



Code	INLETS		OUTLETS	
	N°	Thread	N°	Thread
W0513131101	1	3/8	6	1/8
W0512131121	1	3/8	3	1/4

### 2 INDEPENDENT WAY ROTARY JOINTS



Code	INLETS		OUTLETS	
	N°	Thread	N°	Thread
W0514101101	2	1/8	2	1/8
W0514121121	2	1/4	2	1/4

### 3 INDEPENDENT WAY ROTARY JOINTS



Code	INLETS		OUTLETS	
	N°	Thread	N°	Thread
W0515121121	3	1/4	3	1/4



## SILENCERS



### SILENCER MW SC



	Code	Thread	Quantity
Materials:	W0970530001	M5	50
Nickel-plated brass	W0970530002	1/8	50
Sintered nickel-plated bronze	W0970530003	1/4	50
	W0970530004	3/8	20
	W0970530005	1/2	20
Features:	W0970530006	3/4	10
Pmax: 12 bar	W0970530007	1	10
Temp.: -10°C ÷ +80°C			

### SILENCER MW STT



	Code	Thread	Quantity
Materials:	W0970530042	1/8	50
Nickel-plated brass	W0970530043	1/4	50
Sintered nickel-plated bronze	W0970530044	3/8	20
	W0970530045	1/2	20
	W0970530046	3/4	10
Features:	W0970530047	1	10
Pmax: 12 bar			
Temp.: -10°C ÷ +80°C			

### SILENCED EXHAUST REGULATOR MW SVE



	Code	Thread	Quantity
Materials:	W0970520001	1/8	50
Nickel-plated brass	W0970520002	1/4	50
Sintered nickel-plated bronze	W0970520003	3/8	20
Stainless steel spring	W0970520004	1/2	20
	W0970520005	3/4	10
Features:	W0970520006	1	10
Pmax: 12 bar			
Temp.: -10°C ÷ +80°C			

### SILENCER MW SCQ



	Code	Thread	Quantity
Materials:	W0970530012	1/8	50
Nickel-plated brass	W0970530013	1/4	50
Sintered nickel-plated bronze	W0970530014	3/8	20
	W0970530015	1/2	20
	W0970530016	3/4	10
Features:	W0970530017	1	10
Pmax: 12 bar			
Temp.: -10°C ÷ +80°C			

### SILENCER MW SFE



	Code	Thread	Quantity
Materials:	W0970530051	M5	50
Nickel-plated brass	W0970530052	1/8	50
Stainless steel wire	W0970530053	1/4	50
	W0970530054	3/8	20
	W0970530055	1/2	20
Features:	W0970530056	3/4	10
Pmax: 12 bar	W0970530057	1	10
Temp.: -10°C ÷ +80°C			

### SILENCED EXHAUST REGULATOR MW SVL



	Code	Thread	Quantity
Materials:	W0970520010	M5	50
Nickel-plated brass	W0970520011	1/8	50
Sintered nickel-plated bronze	W0970520012	1/4	50
	W0970520013	3/8	20
	W0970520014	1/2	20
Features:	W0970520015	3/4	10
Pmax: 12 bar	W0970520016	1	10
Temp.: -10°C ÷ +80°C			

### SILENCER MW SE



	Code	Thread	Quantity
Materials:	W0970530021	M5	50
Nickel-plated brass	W0970530020	M7	50
Sintered nickel-plated bronze	W0970530022	1/8	50
	W0970530023	1/4	50
	W0970530024	3/8	20
	W0970530025	1/2	20
Features:	W0970530026	3/4	10
Pmax: 12 bar	W0970530027	1	10
Temp.: -10°C ÷ +80°C			

### SILENCER MW SPL



	Code	Thread	Quantity
Materials:	W0970530062	1/8	50
Black acetal resin	W0970530063	1/4	50
Acoustic insulation	W0970530064	3/8	20
	W0970530065	1/2	20
	W0970530066	3/4	10
Features:	W0970530067	1	10
Pmax: 6 bar			
Temp.: -10°C ÷ +60°C			

### EXHAUST REGULATOR MW DSN



	Code	Thread	Quantity
Materials:	W0970520021	1/8	50
Nickel-plated brass	W0970520022	1/4	50
	W0970520023	3/8	20
	W0970520024	1/2	20
Features:			
Pmax: 12 bar			
Temp.: -10°C ÷ +80°C			

### HIGH-CAPACITY SILENCER MW SL



	Code	Thread	Quantity
Materials:	W0970530036	3/4	10
Nickel-plated brass	W0970530037	1	10
Sintered nickel-plated bronze	W0970530038	1 1/4	5
	W0970530039	1 1/2	5
	W0970530040	2	5
Features:			
Pmax: 12 bar			
Temp.: -10°C ÷ +80°C			

### SILENCER MW SPL-F



	Code	Thread	Quantity
Materials:	W0970530072	1/8	50
Black acetal resin	W0970530073	1/4	50
Felt	W0970530074	3/8	20
	W0970530075	1/2	20
Features:			
Pmax: 12 bar			
Temp.: -10°C ÷ +60°C			

### EXHAUST REGULATOR MW DSE



	Code	Thread	Quantity
Materials:	W0970520031	1/8	50
Nickel-plated brass	W0970520032	1/4	50
Features:			
Pmax: 12 bar			
Temp.: -10°C ÷ +80°C			

## PNEUMO-POWER



TECHNICAL DATA		50-1	50-2	50-3
Maximum power at 7 bar	W	3	7.5	12
Nominal voltage supplied			24 VDC	
Voltage tolerance			±3%	
Ripple and Noise		Including line regulation, load regulation and factory setup mMax 250 mV p-p o 79 mV rms		
Rise time at 7 bar at max. load	sec	Measured at 20Mhz bandwidth by using a pair-wire terminated with a 0.1 µF and 47µF load capacitor		
		2.5	1.5	1
Hold time at 7 bar at 50% of load	sec		See general catalogue	
		1.3	0.9	0.8
Electrical connector		See general catalogue M8 - 3 poles		
Overload protection and short-circuit		"Hiccup mode" with automatic recovery upon cessation of overload		
Overvoltage protection		Intervention if output voltage > 120% than nominal value		
Electromagnetic compatibility		In compliance with the following standards: EN 61000-2: Part 6-2: Generic standards - Immunity for industrial environments EN 61000-2: Part 6-3: Generic standards - Emission standard for residential, commercial and light-industrial environments		
Life at 6.3 bar	h	20.000		
Signals		LED diagnostics. Visual signals are flanked by a diagnostic pin on the M8 connector, which closes a GND contact when the voltage is 24 VDC ±3%		
Index of protection for electronic devices		IP 65		
Input fluid		Filter unlubricated air		
Minimum input pressure	bar	4	3	3
Maximum input pressure	bar	7	7	7
Max air consumption at 7 bar (Leq)	NI/min	32	50	75
Air ports		Input: G1/8" Exhaust: G1/8"		
Temperature range	°C	0 - 50		
Max noise level at 7 bar		75 dB		
Casing material		Painted aluminium		
Assembly position		Any		
Fixing		Using 3 M4x10 screws		
Weight	g	The device can be stabilised using rubber vibration dampers forniti in dotazione 330		

### LED DIAGNOSTICS OVERVIEW

LED off or red LED flashing	Temporarily on start-up: the output voltage has not yet reached 24V If this condition persists, the applied load is probably excessive with respect to the input pressure.
Green LED fixed	Normal operation: the output voltage has reached 24V Optimal use of the compressed air supply.
Green LED flashing	Normal operation: the output voltage has reached 24V but the generator is used below capacity (can supply more power at the same compressed air supply)
Red and Green LED flashing	Charge short-circuited: output voltage is automatically cut off. It will return within the tolerance range upon elimination of overload.
Red LED fixed	The maximum supply pressure has been exceeded and the device risks getting damaged.

### ACCESSORIES

Code	Description
0251530000	PNEUMO POWER 50-1 3 W 24 VDC
0251550000	PNEUMO POWER 50-2 7,5 W 24 VDC
0251570000	PNEUMO POWER 50-3 12 W 24 VDC

#### M8 CONNECTOR WITH CABLE

Code	Description
02240009053	M8 male 3-pin connector with 2.5 metres of cable

## FLOW MICRO-REGULATOR SERIES MRFX



TECHNICAL DATA		1/8"			1/4"			3/8"
		Ø4	Ø6	Ø8	Ø6	Ø8	Ø10	Ø10
Pipe								
Max input pressure	MPa bar psi				1 10 145			
Temperature range	°C °F				0 to 150 32 to 302			
Max flow rate on regulation at 6.3 bar	Nl/min	150	190	200	380	430	500	
Max flow rate on exhaust at 6.3 bar with closed needle	Nl/min	60	110	110	190	250	300	
Max flow rate on exhaust at 6.3 bar with open needle	Nl/min	80	200	250	250	350	380	
Regulation					Allen wrench			
Internal system					Tapered needle			
Fluid					Filtered, lubricated or unlubricated compressed air			

### SYNOPTIC, SIZES AND VERSIONS

M R F FAMILY	O TYPE	X MATERIAL	C FUNCTION	4 Ø PIPE	1/8 Ø THREAD
Flow micro-regulator	O Needle with hexagon socket	X AISI 316L stainless steel	C For cylinder V For valve B Bidirectional	4 Ø 4 6 Ø 6 8 Ø 8 10 Ø 10	1/8 G 1/8" 1/4 G 1/4" 3/8 G 3/8"

Code	Description	Quantity	Code	Description	Quantity	Code	Description	Quantity
9001011CX	MRF Ø X C 4 1/8	5	9001004VX	MRF Ø X V 6 1/4	5	9001006BX	MRF Ø X B 8 1/4	5
9001011VX	MRF Ø X V 4 1/8	5	9001004BX	MRF Ø X B 6 1/4	5	9001008CX	MRF Ø X C 10 1/4	5
9001011BX	MRF Ø X B 4 1/8	5	9001005CX	MRF Ø X C 8 1/8	5	9001008VX	MRF Ø X V 10 1/4	5
9001003CX	MRF Ø X C 6 1/8	5	9001005VX	MRF Ø X V 8 1/8	5	9001008BX	MRF Ø X B 10 1/4	5
9001003VX	MRF Ø X V 6 1/8	5	9001005BX	MRF Ø X B 8 1/8	5	9001009CX	MRF Ø X C 10 3/8	5
9001003BX	MRF Ø X B 6 1/8	5	9001006CX	MRF Ø X C 8 1/4	5	9001009VX	MRF Ø X V 10 3/8	5
9001004CX	MRF Ø X C 6 1/4	5	9001006VX	MRF Ø X V 8 1/4	5	9001009BX	MRF Ø X B 10 3/8	5

## IN-LINE FLOW REGULATOR SERIES RFLX

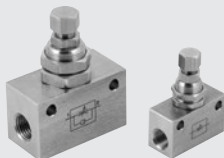

TECHNICAL DATA		1/8"		1/4"	
		Max input pressure	MPa bar psi		
Temperature range	°C °F			0 to 150 32 to 302	
Max flow rate on regulation at 6.3 bar	Nl/min		110		650
Max flow rate on exhaust at 6.3 bar with closed needle	Nl/min		130		500
Max flow rate on exhaust at 6.3 bar with open needle	Nl/min		140		670
Regulation				Box wrench	
Internal system				Tapered needle	
Fluid				Filtered, lubricated or unlubricated compressed air	

### SYNOPTIC, SIZES AND VERSIONS

R F L FAMILY	X MATERIAL	U FUNCTION	1/8 Ø THREAD
In-line flow regulator	X AISI 316L stainless steel	U Unidirectional B Bidirectional	1/8 G 1/8" 1/4 G 1/4"

Code	Description
9041002X	RFL X U 1/8
9041003X	RFL X U 1/4
9041202X	RFL X B 1/8
9041203X	RFL X B 1/4



## KIT PNEUMATIC MOTION® CONFIGURABLE (KIT PMC)



TECHNICAL DATA															
Max operating pressure	bar	10													
	MPa	1													
	psi	145													
Temperature range	°C	-10 to +60													
	°F	14 to 140													
Fluid		Unlubricated air													
Cylinder version		Magnetic double-acting cushioned (Ø12 is not cushioned), C45 chromed and ground piston rod, NBR gaskets													
Cylinder bore	mm	12, 16, 20, 25 to ISO 6432;													
	mm	32, 40, 50, 63, 80, 100, 125, 160, 200 to ISO 15552													
Strokes	mm	for bore 12: strokes from 1 to 200;													
		for bore 16: strokes from 1 to 300;													
		for bores 20 and 25: strokes from 1 to 500;													
		for bores from 32 to 80: strokes from 1 to 2800;													
		for bores 100 and 125: strokes from 1 to 2600; for bores 160 and 200: strokes from 1 to 2800.													
<b>N.B. Cylinders with stroke 50, 100 and 200 are normally available from stock.</b>															
Inrush pressure	bar	Ø 12	Ø 16	Ø 20	Ø 25	Ø 32	Ø 40	Ø 50	Ø 63	Ø 80	Ø 100	Ø 125	Ø 160	Ø 200	
Theoretic force at 6 bar:		0.8	0.6	0.6	0.6	0.4	0.4	0.3	0.3	0.2	0.2	0.2	0.15	0.1	
in thrust	N	68	121	188	295	483	754	1178	1870	3016	4712	7363	12064	18850	
	kg force	6.9	12.3	19	30	49	77	120	191	307	480	751	1230	1922	
in traction	N	51	104	158	247	415	633	990	1682	2721	4418	6881	11310	18096	
	kg force	5.2	10.6	16	25	42	65	101	171	277	450	701	1153	1845	
Accessories for cylinders		Accessories for piston rods and cylinder body selectable via the configurator													
Valve versions	Valve versions	A 90° lever and 24V DC electro-pneumatic valve in the following configurations: 3/2 normally closed; monostable 5/2; bistable 5/2; 5/3 closed centres													
Fittings		Push-in; pipe Ø and thread are chosen by the configurator to fit the selected cylinder or valve.													
Flow regulator		Taper pin with push-in fitting, can be adjusted either manually or with a screwdriver. Pipe Ø and thread are chosen by the configurator according to the cylinder selected.													
Coil		22 mm side, 2W, 24VDC													
Position sensors		T7 Series SQUARE, REED with 2 wires 2.5 m or HALL with 3 wires 2.5 m													
Pipe		Ø chosen by the configurator according to the cylinder selected. Freely settable length [m]													

**N.B.:** For detailed information of each individual component, see the specific chapters.

## KIT PNEUMATIC MOTION® READY (KIT PMR)



TECHNICAL DATA																	
Max operating pressure	bar	10															
	psi	145															
Temperature range	°C	-10 to +60															
	°F	14 to 140															
Fluid		Unlubricated air															
Cylinder version		Magnetic double-acting cushioned, C45 chromed and ground piston rod, NBR gaskets															
Cylinder bore	mm	25				32				50							
Strokes	mm	50; 100				50; 100; 200				50; 100; 200							
Inrush pressure	bar	0.6				0.4				0.3							
Theoretic force at 6 bar:	N	295				483				1178							
	kg force	30				49				120							
in traction	N	247				415				1057							
	kg force	25				42				108							
Valve versions		With 90° lever, 5/2 1/8"; electropneumatic, monostable 5/2 1/8", 24VDC															
Fittings		Push-in for Ø 6 pipe, 1/8" thread															
Flow regulator		With taper pin, push-in fitting for Ø 6 pipe, regulation by hand or with a screwdriver															
Coil		Side 22 mm, 2W, 24VDC															
Position sensors		T7 Series SQUARE, REED with 2 wires 2.5 m															
Pipe		Outside Ø 6 mm, inside Ø 4 mm, polyurethane															
Tubo		Ø esterno 6 mm, interno 4 mm, poliuretano															

## ORDERING CODES

### JOYSTICK VERSION, WITH MANUAL LEVER CONTROL

Code	KIT COMPONENTS Description
900410252000001	ISO 6432 cylinder Ø 25, stroke 50, magnetic, cushioned MRF flow regulator, Compact N, technopolymer C 6 1/8 + parts common to all Joystick kits *
900410252000002	ISO 6432 cylinder Ø 25, stroke 100, magnetic, cushioned MRF flow regulator, Compact N, technopolymer C 6 1/8 + parts common to all Joystick kits *
900410322000001	ISO 15552 cylinder Ø 32, stroke 50, magnetic, cushioned MRF flow regulator, Compact N, technopolymer C 6 1/8 + parts common to all Joystick kits *
900410322000002	ISO 15552 cylinder Ø 32, stroke 100, magnetic, cushioned MRF flow regulator, Compact N, technopolymer C 6 1/8 + parts common to all Joystick kits *
900410322000003	ISO 15552 cylinder Ø 32, stroke 200, magnetic, cushioned MRF flow regulator, Compact N, technopolymer C 6 1/8 + parts common to all Joystick kits *
900410502000001	ISO 15552 cylinder Ø 50, stroke 50, magnetic, cushioned MRF flow regulator, Compact N, technopolymer C 6 1/4 + parts common to all Joystick kits *
900410502000002	ISO 15552 cylinder Ø 50, stroke 100, magnetic, cushioned MRF flow regulator, Compact N, technopolymer C 6 1/4 + parts common to all Joystick kits *
900410502000003	ISO 15552 cylinder Ø 50, stroke 200, magnetic, cushioned MRF flow regulator, Compact N, technopolymer C 6 1/4 + parts common to all Joystick kits *

- \* Parts common to all Joystick kits
  - Valve with 90° lever 5/2 1/8, MAV 25 LEB OO
  - Straight push-in fitting RL1 6 1/8
  - Silencer series MWSFE 1/8
  - Straight push-in fitting RL2 6 1/4 female
  - TCE M4x30 screw to UNI 5931/8.8, galvanised
  - C98 polyurethane pipe, outside Ø 6, inside Ø 4

### ELECTRIC VERSION, WITH SOLENOID VALVE CONTROL AND POSITION SENSORS

Code	KIT COMPONENTS Description
900410251000001	ISO 6432 cylinder Ø 25, stroke 50, magnetic, cushioned MRF flow regulator, Compact N, technopolymer C 6 1/8 Sensor clamp for Ø 25 cylinder + parts common to all Electric kits *
900410251000002	ISO 6432 cylinder Ø 25, stroke 100, magnetic, cushioned MRF flow regulator, Compact N, technopolymer C 6 1/8 Sensor clamp for Ø 25 cylinder + parts common to all Electric kits *
900410321000001	ISO 15552 cylinder Ø 32, stroke 50, magnetic, cushioned MRF flow regulator, Compact N, technopolymer C 6 1/8 + parts common to all Electric kits *
900410321000002	ISO 15552 cylinder Ø 32, stroke 100, magnetic, cushioned MRF flow regulator, Compact N, technopolymer C 6 1/8 + parts common to all Electric kits *
900410321000003	ISO 15552 cylinder Ø 32, stroke 200, magnetic, cushioned MRF flow regulator, Compact N, technopolymer C 6 1/8 + parts common to all Electric kits *
900410501000001	ISO 15552 cylinder Ø 50, stroke 50, magnetic, cushioned MRF flow regulator, Compact N, technopolymer C 6 1/4 + parts common to all Electric kits *
900410501000002	ISO 15552 cylinder Ø 50, stroke 100, magnetic, cushioned MRF flow regulator, Compact N, technopolymer C 6 1/4 + parts common to all Electric kits *
900410501000003	ISO 15552 cylinder Ø 50, stroke 200, magnetic, cushioned MRF flow regulator, Compact N, technopolymer C 6 1/4 + parts common to all Electric kits *

- \* Parts common to all Electric kits Electric
  - Solenoid valve 5/2, monostable 1/8, SOV 25 SOS OO
  - Straight push-in fitting RL1 6 1/8
  - Silencer series MWSFE 1/8
  - Coil 22 mm 2W 24VDC
  - Connector 22 mm
  - Sensor T7 square Reed 2 wires, 2.5 m
  - Straight push-in fitting RL2 6 1/4 female
  - TCE M4x30 screw to UNI 5931/8.8, galvanised
  - C98 polyurethane pipe, outside Ø 6, inside Ø 4

**NOTE**

---

---

---

---

---

---

---

---

---

---

---

---

---

---

---

---

---

---

---

---

---

---

---

---

---

---











