



Parker Legris: Connecting You to the Best in Technology

aerospace
climate control
electromechanical
filtration
fluid & gas handling
hydraulics
pneumatics
process control
sealing & shielding



ENGINEERING YOUR SUCCESS.



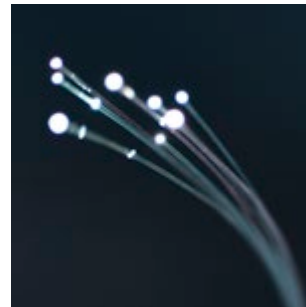

A new Parker Legris catalogue is always an event.

We have updated the content so that this edition offers an even wider range of products for more applications: the range of LIQUIfit® fittings with metal adaptors for conveying beverages and fluids, the optic fibre range designed for "FTTx" infrastructures, as well as ranges specific to braking systems in trucks.

Our catalogue is available in different formats - paper, web, interactive - in order to facilitate product search. Stay connected, regardless of where you are: on the internet, a tablet, a smartphone...the information is just a click away!

Very complete and easy to use, this catalogue will be a useful tool, guiding you in the choice of solutions specific to your applications.

For advice or more information, please do not hesitate to contact us. Visit our web site today: www.parkerlegris.com.



A Century of Dedication and Enthusiasm...

Inventor of the push-in fitting, Legris joined the Parker Hannifin Corporation, world leader in motion and control technologies, in October 2008.

3 Industrial Activities

Optimising the transport and control of many fluids (compressed air, liquids, gas) through innovative product design has been the motto of our teams for more than 100 years.

Today, Parker Legris' expertise is divided into three business activities:

Legris Connectic: fittings, couplers, function fittings, valves, tubing and accessories for industrial applications.

Legris Transair: air and fluid distribution systems for industrial buildings.

Legris Autoline: push-in connection solutions for automobile fuel lines.

150 Years of History

Our experience and expertise in the design, manufacturing and marketing of high-quality connectors allow us to provide our customers with solutions adapted to a variety of applications.

- 1848** Legris, a small valve manufacturer in France
- 1969** Invention of the LF 3000®, the first push-in fitting for compressed air
- 1988** Legris becomes a division of the Legris Industries Group

- 1996** Launch of Transair®
- 1997** Launch of Autoline
- 2008** Acquisition of Legris by the Parker Hannifin Corporation
- 2009** Legris becomes Parker Legris, a division of the Parker group



...Supporting Industrial Connectivity

Parker Legris Sites

Parker Legris has 7 locations distributed across Europe.

France: Baillé, Guichen, Malestroit, Muzillac, Rennes

Belgium: Herstal

Spain: Terrassa

Industrial Applications

Our products are used everywhere fluid control is required.

Our knowledge and expertise are deployed in a variety of sectors: production automation, packaging, transport, food process, and the medical industry.

Parker Legris is also involved in innovative sectors such as renewable energy, information and communication technologies.

Our Distribution Network

We encourage local support and long-term partnerships with our customers.

Through our many sales outlets, professionals are on hand to provide you with technical advice and to offer you a wide choice of products local to your sites.

Do not hesitate to contact them for further information and advice.

1940



2012



Your Applications Inspire Our Innovation

Innovation is Parker Legris' number one priority in order to provide solutions that meet your technological, energy reduction and environmental challenges.

Our expertise is continually improving

We continually invest in our tools in order to anticipate market requirements in terms of industrial efficiency. Furthermore, our long-term partnerships with the most qualified organisations (universities, skills hubs, etc.) enable us to incorporate the latest technological advances in our product development. Lastly, constantly incorporating your needs into the design of our products keeps us at the forefront of the new industrial challenges.

Together, we can build advanced and unique connector solutions

Here are a few examples:

To increase the efficiency of your systems

The new LIQUIfit® range with metal adaptors - 316L stainless steel or FDA nickel-plated brass - designed for the transfer of industrial fluids, complements our push-in fitting range.

To establish ultra high speed optic fibre networks

A brand-new range of push-in fittings combining transparency and proven technical characteristics has been developed. These connectors and gas blocks connect the micro-tubing that protects the optic fibre cables.

To connect and ensure safe brake circuits for commercial vehicles

The Prestomatic ranges offer to this type of vehicle manufacturer the possibility of producing service brake circuits that meet strict safety requirements.

This catalogue also contains details of our latest products:

Prestomatic 2, the PL range, customised products, promotional kits for blowguns, new technical characteristics for our standard ranges, new adaptors and much more.



Quality and Safety, the Basis of Our Commitment

Our target is to provide our customers with the best solution and the highest quality. Certified ISO/TS 16949, Parker Legris includes customer quality at the heart of its processes.

Invest in quality for increased productivity

The cost of a production stoppage due to a defective part is greater than the cost of all the connectors in the machine. Choosing the quality of the components in your machine is thus of primary importance; it also guarantees the safety and welfare of your employees. Furthermore, investing in quality increases your productivity over the long term and contributes to maintaining your brand image.

We guarantee the quality and traceability of our solutions

Our products are fully inspected and dated individually during production in order to ensure quality and traceability.

We commit our name and our image to yours through the quality of our products.

We protect your connectors to give you peace of mind

Our company exceeds its statutory responsibilities with regard to the safety of individuals and systems.

Certification and qualification processes are integrated upstream of our developments.

We ensure the performance of your installations

Our product ranges are designed with a high safety factor and comply with quality management processes.

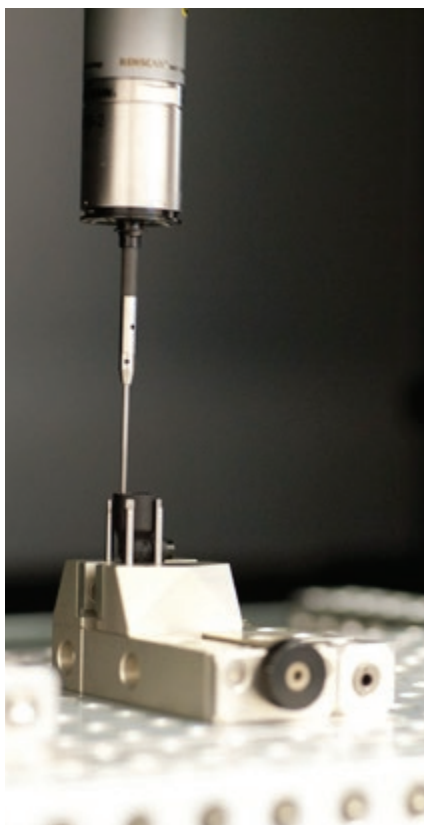

Our Services Contribute to Your Performance

Our services integrate easily into your processes. Whether during the design phase, for promotion, or for administrative, business, or stock management of your components, our skills are here for you to use.

Customised Products

We can help you develop customised solutions: fittings, manifolds, valves, etc.



EDI Transmission

Implementation of computerised data exchange.



Improved Stock Management

Packaging, bar codes and customised labels according to your needs.



Technical Specifications

All the technical data for our products is available on-line.



2D and 3D Drawings

The CAD drawings of our products are available on-line in the 21 main formats used by the industry (Solidworks, Autocad, Pro/E, etc.).

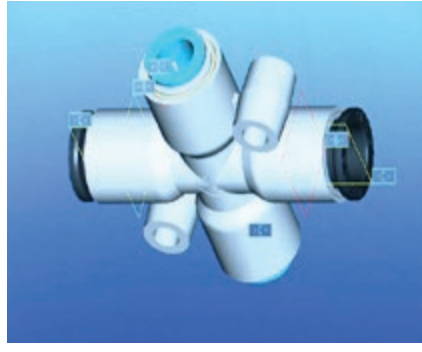

Certificates and Regulations

Certificates of conformity for our products are available on our web site. Contact us for any further information you require.

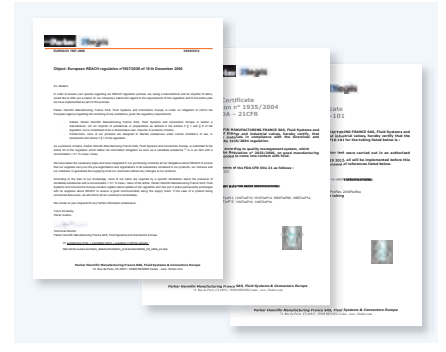

e-Tools

Requests for quotations, stock availability, energy-saving calculators, searching for cross-references, etc. are available on-line.

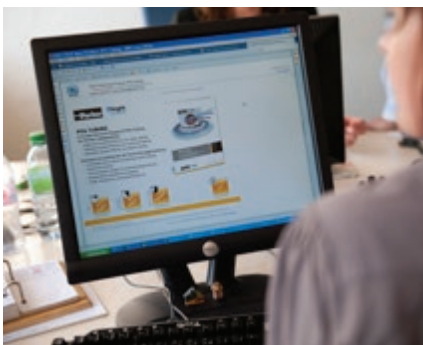

Communication Tools

We can provide you with any promotional sales material you require: brochures, flash animations, sample kits, etc.



e-Catalogue

Integration of our product data into your information systems (e-procurement, e-commerce site, etc.).



Together, We Can Build Sustainable Development

Parker Legris, ISO 14001 certified, has made the conservation of resources and protection of the environment a major priority. Through our Eco-Design approach, we have incorporated improved environmental management as a permanent feature in the vision and mission of the company, aiming to benefit nature, technology and mankind.



Protecting natural resources

By saving energy through the performance of our production facilities.

Improving performance

By changing habits in order to promote new materials and concepts.

Asserting our values for the protection of the environment

By having all our sites ISO 14001 certified in order to unify all our employees around clear objectives regarding the management of the environment.

Our actions are coupled with your environmental process

Reducing the impact on industrial sites

Parker Legris has integrated environmental protection management into the operation of its industrial sites. This approach has enabled 85% of waste to be recovered and has reduced energy consumption by 15%.

Offering ecologically responsible products

Under its continuous improvement process, Parker Legris has integrated ecological design as an input parameter to innovation and uses Life Cycle Assessment (LCA) to optimise the environmental impact of its products.

Providing information on the PEP (Product Environmental Profile)

This communication tool is common to all industries and professions and delivers a reliable and clear message for promoting ecological advances and incorporating this data within the LCA equipment.

Getting ahead of regulations

Parker Legris goes beyond its statutory obligations and endeavours to find a good match between choice of materials, limitation of hazardous substances, selection of recycling channels and industrial performance to encourage the recycling of products at end of life.

Using our technology reduces the environmental impact

LIQUIFIT®

Tube-to-Tube Connector



Market Standard

Tube-to-Tube Connector

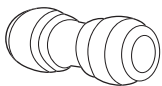

- Parker Legris
- Market Standard in PP
- Market Standard in POM

Tube-to-Tube Connector

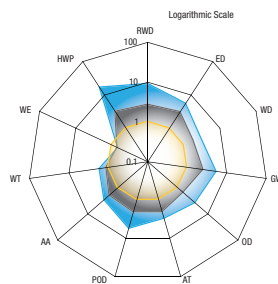

- RWD: Raw Material Depletion
- ED: Energy Depletion
- WD: Water Depletion
- GW: Global Warming

- OZ: Ozone Depletion
- AT: Air Toxicity
- POC: Photochemical Ozone Creation
- AA: Air Acidification

- WT: Water Toxicity
- WE: Water Eutrophication
- HWP: Hazardous Waste Production

Generation 2



Generation 3



Manufactured according to our continuous Eco-Design approach, the LF 3000® fitting optimises the environmental impact of the products.



Global Warming: Gains in terms of CO₂ rejection during a product's life cycle



Directives and Regulations:

Parker Legris complies with the directives and regulations listed below and goes beyond its statutory obligations for the ranges in question.

Industrial Regulations



European RoHS directives: 2011/65/EC
Relating to the limitation of the use of 6 hazardous substances in electrical and electronic equipment (mercury, lead, cadmium, hexavalent chromium, PBB and PBDE).



REACH regulation: 1907/2006
As a product manufacturer, we are subject to article 33 of the regulation which defines a duty to inform when a candidate substance is present at more than 0.1% weight for weight.



Pressurised equipment directive: 97/23/EC
This directive regulates the design, manufacture and assessment of pressurised equipment to ensure operating safety.

Machinery Directive 2006/42/EC
This directive harmonizes the safety and health requirements for machines with a high protection level. It also guarantees the free movement of machines on the European Union market.



ATEX directive: 94/9/EC mandatory since 01/07/2003
This directive is mandatory for electrical and non-electrical equipment used in explosive gaseous or dusty atmospheres. The use of our products in these areas must be determined in accordance with the ATEX environment.



Pneumatic fluid power, push-in connectors for thermo-plastic tubing.



Standard for safety of flammability of plastic materials for parts in devices and appliances.



For grease only.
Federal Institute for Materials Research and Testing
Certification for the sensitivity to inflammation of oxygen gas.



Resistance to water and dust seepage

Food Process Regulations and Certifications



Regulation 1935/2004
This framework regulation relates to materials and objects designed to come into contact with foodstuffs. It describes specific measures per product group (Art. 5).



**CFR 21: Code of Federal Regulation
Title 21: Food and Drugs**
This code consists of lists of prohibited substances for materials intended to come into contact with foodstuffs.



NSF 51: NSF / ANSI-51
Fittings and tubes complying with this standard are tested and approved by NSF for contact with drinks and foodstuffs.

Quality Management Certification



ISO TS 16949
Quality management systems - particular requirements for the application of ISO 9001:2000 for automotive production and relevant service part organizations.

ISO 14001
Environmental management systems.
Requirements with guidance for use.

ISO 9001
This international standard specifies requirements for a quality management system when an organisation needs to demonstrate its ability to consistently provide products that meet customer and applicable statutory and regulatory requirements.

Medical Devices - Quality Management Systems: Requirements for Regulatory Purposes

This international standard specifies requirements for a quality management system where an organisation needs to demonstrate its ability to provide medical devices and related services that consistently meet customer requirements and regulatory requirements applicable to medical devices and related services.

ISO 13485
(pending)

The Parker Legris product range offers compliance with numerous European standards associated in particular with the directives and regulations referred to above. The official texts of these directives are available on the site: <http://eur-lex.europa.eu>.

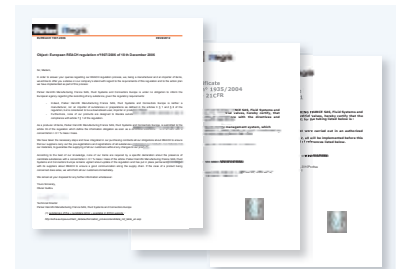

the Parker Legris Offer

Water Treatment Certifications



NSF 61: NSF / ANSI-61

Fittings and tubes complying with this standard are tested and approved by NSF for contact with drinking water.



NSF 42 and 58: NSF/ANSI-42/58

Tubes complying with this standard are tested and approved by NSF for drinking water treatment systems.



ACS: Attestation de Conformité Sanitaire (France)
Official approval issued by the Direction générale de la Santé Française (French Health Directorate), applies to constituent materials of equipment in contact with water intended for human consumption.

KTW

KTW: Kunststoffe und Trinkwasser

 (Germany)

Guidelines for the health evaluation of equipment in contact with drinking water, assessment and certification carried out by the TZW.

W270

W270: Food contact standard

 (Germany)

Standard describing a test method for determining the microbial growth on non-metal materials designed to come into contact with drinking water.
Test and certification carried out by the TZW.



WRAS: Water Regulations Advisory Scheme

 (UK)

Fittings approved by this programme are declared compliant for water supply by WRc - NSF.



DM 174: Ministerial decree

 (Italy)

Declaration of hygiene compliance for equipment used for drinking water, tested and certified by the TIFQ.

Regulations and Certifications for Life Sciences & Clean Room Applications

**USP
Class VI (A)**

The United States Pharmacopeia (USP) establishes standards to ensure the quality of medicines and other health care technologies.

ASTM G93

Standard Practice for Cleaning Methods and Cleanliness Levels for Material and Equipment Used in Oxygen-Enriched Environments

This practice covers the selection of methods and apparatus for cleaning materials and equipment intended for service in oxygen-enriched environments. Contamination problems encountered in the use of enriched air, mixtures of oxygen with other gases, or any other oxidizing gas may be solved by the same cleaning procedures applicable to most metallic and non-metallic materials and equipment.

ISO 14644-1

Clean Rooms and Associated Controlled Environments. Part 1: Classification of Air Cleanliness. The document covers the classification of air cleanliness in clean rooms and associated controlled environments exclusively in terms of concentration of airborne particles. Only particle populations having cumulative size distributions based on threshold (lower limit) size ranging from 0.1 μm to 5 μm are considered for classification purposes.

Railway Regulations



EN 45545-2

Railway applications - fire protection on railway vehicles. Requirements for fire behavior of materials and components.

DIN 5510-2

Preventive fire protection in railway vehicles. Determines levels of protection, fire preventive measures and certification.

NF F16-101

Method of classification of materials for rolling stock obtained from the results of standardised tests. Takes into account the combustion of the materials as well as the opacity and toxicity of emissions.



Optic Fibre Regulations

EN 50086-2-4 replaced by NF EN 61386-24

Standard related to impact tests for buried systems.

EN 50411-2-8

Fibre organisers and closures to be used in optical fibre communication systems.

Regulations and Standards for Transportation



EURO 6

Standard that reduces the level of certain polluting gases.

DIN 74324, DIN 73378

Specification and tests related to thermoplastic tubing.

Technical Guidelines

Compressed Air Flow and Pressure Drop

Flow represents the quantity of compressed air passing through a section per unit time. It is expressed in l/min, m³/min or m³/h, at the value expressed in free air, under Standard Reference Atmospheric conditions (ANR) namely: **+20°C, 65 % relative humidity, 1.013 bar**, according to standards NFE 48100 and ISO R554, R558.

When in open position and subject to a supply pressure (**P**), the pneumatic component provides a flow (**d**) which generates a pressure drop at the outlet. The pressure difference therefore between the inlet orifice (upstream pressure) and the outlet orifice (downstream pressure), is called the **pressure drop** and is designated by **ΔP** (pressure differential).

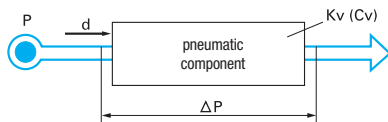

The **maximum allowable working pressure** of a component is the effective pressure to which this component may be subjected in a given installation.

The **upstream pressure** is the compressed air pressure at the component inlet.

The **downstream pressure** is the outlet pressure from the component.

The **differential pressure (ΔP)** is the pressure difference between the upstream and downstream pressures.

In order to have simple and usable values available for carrying out calculations and comparing the performances of pneumatic components, we use a flow factor called **Kv**. This experimental factor characterises the flow capacity of a component. It equates to the practical value of the flow of water in litres/minute under a Δp of 1 bar with bore fully open.

The flow factor Kv equates to a coefficient of conductivity - the higher its value, the better the flow provided by the component.

The Kv and pressure drop are linked by the following relationship:

$$Q_v = 26.7 K_v \sqrt{\Delta p \times P_{\text{upstream}}}$$

Q_v = flow in l/min (ANR)

K_v = flow factor

Δp = in bar

P upstream: in bar absolute

Cv is a flow factor equivalent to Kv, but expressed in US gallons per minute under a Δp of 1 PSI. Kv and Cv are therefore linked by the following relationships:

$$K_v = 14.3 C_v \quad - \quad C_v = 0.07 K_v$$

The flow indicated for certain products in the Parker Legris catalogue is the average flow at 6 bar expressed in NI/min of depressurised air at the Standard Reference Atmosphere (ANR).

Pressure

The normal atmospheric pressure of the air is 1.013 bar at sea level (0 m altitude). It is generally used as a reference for pressure measurements but varies with altitude. For tests and measurements, it is preferable to use absolute bar which relates to an absolute pressure.

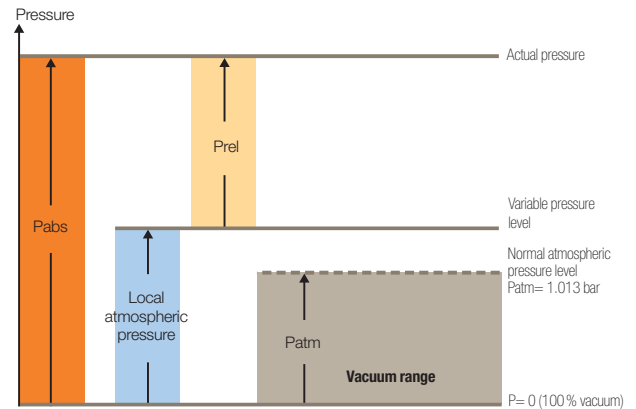

$$P_{\text{abs}} = P_{\text{atm}} + P_{\text{rel}}$$

P_{abs} : absolute pressure

P_{rel} : relative pressure

P_{atm} : atmospheric pressure

The pressure is expressed in bar according to industrial practice. It is the result of a force of daN applied to a surface area in cm².

$$1 \text{ bar} = \frac{1 \text{ daN}}{1 \text{ cm}^2} = 10^5 \text{ pascal}$$

Vacuum and Vacuum Levels

Vacuum appears when the atmosphere is rarefied. By removing the air from an enclosed space, a depression (or vacuum) is created relative to atmospheric pressure.

Vacuum therefore relates to the state of a fluid where the pressure is less than atmospheric pressure.

The vacuum level may be expressed as:

depression level = relative pressure value compared to atmospheric pressure

vacuum level in absolute value (defined in comparison with absolute zero)

The common unit of vacuum is the millimetre of mercury (**mm Hg**).

Classification of vacuum

• medium vacuum	10 ¹³	to	10 mbar absolute
• primary vacuum	10	to	10 ⁻³ mbar absolute
• secondary vacuum	10 ⁻³	to	10 ⁻⁶ mbar absolute
• molecular vacuum	10 ⁻⁶	to	10 ⁻⁹ mbar absolute
• ultra-vacuum			< 10 ⁻⁹ mbar absolute

Conversion Tables

Units Used in this Catalogue

1 meter = 3.281 feet
1 foot = 0.30480 meters

Symbol	Unit
A	ampere
bar	bar
°C	degree Celsius
dBA	decibel
Hz	hertz
kg	kilogram
m	metre
m²	square metre
m³/h	cubic metres per hour
min	minute
mm	millimetre
mm Hg	millimetres of mercury
N	Newton
NI	litres at standard reference atmospheric pressure (ANR)*
V	volt

Units of Flow

l/min	Cfm	m³/h
600	21	36
1200	43	72
1800	64	108
2400	85	144
3000	106	180
3600	128	216
4200	149	252
4800	170	288
5400	191	324
6000	213	360
6600	234	396
7200	255	432
7800	277	468

*Parker Legris carries out its tests under normal pressure and temperature conditions (1013 mbar, +20°C). All flows mentioned in this catalogue are therefore expressed in NI/min.

Units of Vacuum

Depression (mm Hg)	Vacuum (%)	Absolute Pressure (mbar)	Depression (mbar)
0	0	1000	0
-75	10	900	-100
-100	13.3	867	-133
-150	20	800	-200
-200	26.7	733	-267
-225	30	700	-300
-300	40	600	-400
-375	50	500	-500
-400	53.3	467	-533
-450	60	400	-600
-500	66.7	333	-667
-525	70	300	-700
-600	80	200	-800
-675	90	100	-900
-690	92	80	-920

Units of Pressure

1 bar = 100.000 Pa = 100 kPa = 14.5 psi
1 Pa = 0.00001 bar = 0.000145 psi
1 psi = 0.069 bar = 6897.8 Pa

bar	kPa	psi	psi	kPa	bar
0.0005	0.05	0.0073	0.007	0.05	0.0005
0.001	0.10	0.0145	0.015	0.1	0.0010
0.005	0.5	0.0725	0.070	0.48	0.0048
0.01	1	0.145	0.150	1.04	0.0104
0.05	5	0.725	0.700	4.83	0.0483
0.069	6.9	1.000	1.000	6.90	0.0690
0.1	10	1.450	1.500	10.35	0.1035
0.25	25	3.625	3.000	20.70	0.2070
0.5	50	7.250	7.000	48.30	0.4830
0.75	75	10.875	10.000	69.00	0.6900
1.0	100	14.500	15.000	103.50	1.0350
1.5	150	21.750	20.000	138.00	1.3800
2.0	200	29.000	25.000	172.50	1.7250
2.5	250	36.250	30.000	207.00	2.0700
3.0	300	43.500	35.000	241.50	2.4150
3.5	350	50.750	40.000	276.00	2.7600
4.0	400	58.000	50.000	345.00	3.4500
4.5	450	65.250	60.000	414.00	4.1400
5.0	500	72.500	70.000	483.00	4.8300
5.5	550	79.750	80.000	552.00	5.5200
6.0	600	87.000	90.000	621.00	6.2100
7.0	700	101.500	100.000	690.00	6.9000
8.0	800	116.000	110.000	759.00	7.5900
9.0	900	130.500	125.000	828.00	8.2800
10.0	1000	145.000	150.000	1035.00	10.3500
12.0	1200	174.000	175.000	1207.50	12.0750
14.0	1400	203.000	200.000	1380.00	13.8000
16.0	1600	232.000	225.000	1552.50	15.5250
18.0	1800	261.000	250.000	1725.00	17.2500
20.0	2000	290.000	300.000	2070.00	20.7000

Units of Temperature

0 °C = +32 °F
0 °F = -17.8 °C

°F	°C	°C	°F
-40	-40.0	-40	-40
-30	-34.4	-30	-22
-20	-28.9	-20	-4
-10	-23.3	-10	+14
0	-17.8	0	+32
+10	-12.2	+10	+50
+20	-6.7	+20	+68
+30	-1.1	+30	+86
+40	+4.4	+40	+104
+50	+10.0	+50	+122
+60	+15.6	+60	+140
+70	+21.1	+70	+158
+80	+26.7	+80	+176
+90	+32.2	+90	+194
+100	+37.8	+100	+212
+110	+43.3	+110	+230
+120	+48.9	+120	+248
+130	+54.4	+130	+266
+140	+60.0	+140	+284
+150	+65.6	+150	+302
+160	+71.1	+160	+320
+170	+76.7	+170	+338
+180	+82.2	+180	+356
+190	+87.8	+190	+374
+200	+93.3	+200	+392
+210	+98.9	+210	+410
+220	+104.4	+220	+428
+230	+110.0	+230	+446
+240	+115.6	+240	+464
+250	+121.1	+250	+482

Fitting Threads

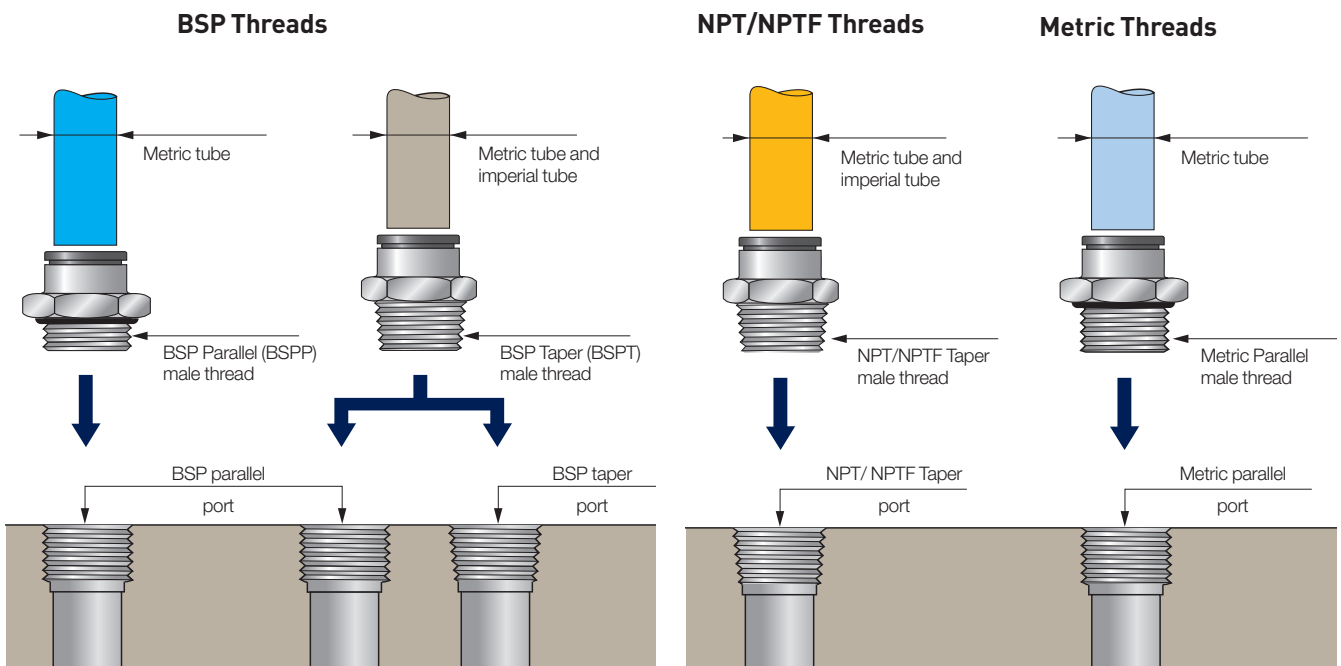

BSP Threads (British Standard Pipe)

There are two types of "Pipe" profile threads:

- **Parallel (BSPP):** these threads fit in matching parallel ports. Sealing is provided by an O-ring gasket or a sealing washer.
- **Taper (BSPT):** these threads fit in matching parallel or taper ports. Sealing is provided by a pre-coating on the thread.

Thread designation

• BSP Parallel (BSPP):

G followed by the denomination, according to standard ISO 228-1.
Example: 1/8 BSP parallel thread = G1/8

• BSP Taper (BSPT):

R followed by the denomination, according to standard ISO 7-1.
Example: 1/8 BSP taper (BSPP) thread = R1/8

• Female threads:

BSP parallel: G followed by the designation
BSP taper: R followed by the designation

NPT Threads (National Pipe Thread)

This is an American standard taper thread which fits into the matching taper port. Sealing is provided by a pre-coating on the thread.
Example: 1/8 NPT thread = 1/8 NPT

NPTF Threads (National Pipe Thread Fuel)

This is an American standard taper thread which fits into the same taper port with no additional sealing or into a taper port with a sealant.

Metric Threads

These ISO-profile threads are parallel and are fit into the matching parallel port. Sealing is provided by an O-ring or a sealing washer.

Thread designation

- M depending on the diameter and pitch in millimetres, separated by a multiplication sign, in accordance with standards ISO 68-1 and ISO 965-1.
Example: metric thread diameter 7 with a pitch of 1 mm = M7x1

Thread Identification

BSP Thread	Code	NPT/NPTF Threads	Code
1/8"	10	1/16"	08
1/4"	13	1/8"	11
3/8"	17	1/4"	14
1/2"	21	3/8"	18
3/4"	27	1/2"	22
1"	34	3/4"	28
1 1/4"	42	1"	35
1 1/2"	49	1 1/4"	43
2"	48	1 1/2"	50
		2"	44

Metric Thread	Code	Metric Thread	Code	Metric Thread	Code
M3x0.5	09	M12x1.25	66	M22x1.5	82
M5x0.8	19	M12x1.5	67	M24x1.5	83
M6x1	52	M13x1.25	68	M27x1.5	85
M7x1	55	M14x1.25	70	M30x2	88
M8x1	56	M14x1.5	71	M33x1.5	90
M8x1.25	57	M16x1.25	74	M39x1.5	36
M10x1	60	M16x1.5	75	M42x1.5	37
M10x1.5	62	M18x1.5	78	M42x2	96
M12x1	65	M20x1.5	80	M48x2	98

Principle and Advantages of Our Connection Systems

A very large number of technical solutions exist for connecting two pipes together. Leader in industrial connection systems, Parker Legris offers a very wide range of technologies and materials to cover all requirements.

Push-In Fittings

Tube retention with gripping ring

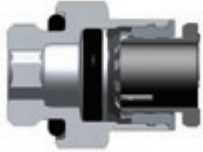

Tube retention with collet

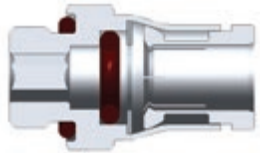

Tube retention with reversed collet

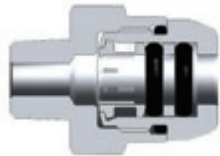

Principle

Connected and sealed simply by pushing the tube into the fitting.
Disconnected by pushing on the release button.

Tube retention with gripping ring:

- No damage to the tube
- Ideal for polymer tubes
- Particularly compact

Tube retention with collet:

- Robust solution for harsh environments
- Resistant to high pressure, excellent lifespan
- Ideal for grooved metal tubes

Tube retention with reversed collet:

- Protected disconnection
- Can withstand very high pressures
- Double sealing

Advantages

Allows flexible and modular systems to be produced quickly.

Provides a compact and lightweight connection solution.

Facilitates installation due to a swivelling body.

Reliability of the connection ensured through the one-piece design.

Suitable for use with a wide range of tubes.

Prolongs the lifespan of your systems.

Compression Fittings



Principle

Connection and sealing achieved by crimping a metal olive onto a tube.
The seals are metal to metal.

Advantages

Can withstand very high pressures and temperatures.

Allows all types of tube to be connected, both polymer and metal.

Increases the lifetime of the fitting.

Spigot Compression Fittings



Principle

Connection and sealing by the distortion and gripping of a plastic tube.

Advantages

Intended for the connection of very flexible or non-calibrated tubes.

Couplers

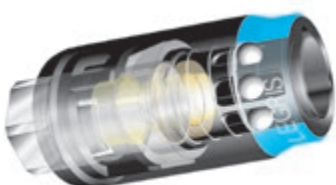

Principle

A probe with an international profile connects the circuit to the coupler. Certain couplers have a safety device which enables the circuit to be vented before releasing the probe.

Advantages

Suitable for frequent connection and disconnection.

Product Selection Table

Push-In Fittings	Materials	Fluids	Maximum Pressure (bar)	Temperature		Performance in Aggressive Environments	
				Min.	Max.	Mechanical	Chemical
LF 3000®	Technical polymer/brass/NBR	Compressed air	20	-20°C	+80°C	Good	Moderate
LF 3200	Nickel-plated brass/NBR	Compressed air	20	-15°C	+80°C	Excellent	Moderate
LIQUIfit®	Bio-sourced polymer/nickel-plated brass FDA/316L stainless steel/EPDM	Liquids	16	-10°C	+95°C	Moderate	Good
LF 6270, Optic Fibre	Polycarbonate /NBR or silicone	Compressed air or water	25	-20°C*	+80°C	Excellent	Moderate
Prestomatic 3	Technical polymer/brass/NBR	Compressed air, air-brake systems	25	-50°C*	+100°C	Good	Moderate
Prestomatic 2	Brass/NBR	Compressed air, air brake systems	25	-50°C*	+100°C	Good	Moderate
LF 3600	Chemical nickel-plated brass FDA/FKM	All brass-compatible fluids	30	-25°C	+150°C	Excellent	Good
LF 6100	Brass/NBR	Oil, analytical gases	60	-40°C	+120°C	Excellent	Moderate
LF 3800 / LF 3900	316L - 303 stainless steel/FKM	All fluids	30	-25°C	+150°C	Excellent	Excellent

*temperature must be lowered while circuit is under pressure

Cartridges and Customised Products

LF 3000®	Technical polymer/brass or chemical nickel-plated brass/NBR	Compressed air	20	-20°C	+80°C	Good	Moderate
LIQUIfit®	Bio-sourced polymer/ brass or nickel-plated brass/EPDM	Liquids	16	-10°C	+95°C	Moderate	Good
LF 3600	Chemical nickel-plated brass FDA/FKM	All brass-compatible fluids	30	-20°C	+150°C	Excellent	Good
LF 3800 / LF 3900	316L - 303 stainless steel/FKM	All fluids	30	-20°C	+150°C	Excellent	Excellent
FTL	Brass/NBR	Compressed air	16	-25°C	+80°C	Good	Moderate

Technical Tubing and Hose

Semi-Rigid PA	Semi-rigid bio-sourced polyamide	Compressed air, industrial fluids	50	-40°C	+100°C	Good	Good
Rigid PA	Rigid polyamide	Compressed air, industrial fluids	58	-40°C	+80°C	Good	Good
Fireproof High Resistance PA	Polyamide with flame-retardant additive	Coolants, industrial fluids (lubricants), compressed air	50	-50°C	+100°C	Excellent	Moderate
Anti-Spark PA and PU with or without PVC sheath	Semi-rigid polyamide with PVC sheath Polyurethane ether with PVC sheath Single-layer polyurethane ether with flame-retardant additive	Compressed air, coolants, industrial fluids	36 (PA) 14 (PU)	-20°C	+80°C +70°C	Excellent	Good
PU single and multi-tube	Polyurethane ester Polyurethane ether "Crystal" food-quality polyurethane ether	Compressed air, industrial fluids (water) or food industry fluids	12	-20°C	+70°C	Excellent	Moderate Good Good
Antistatic PU	Polyurethane filled with conductive particles	Compressed air	10	-20°C	+70°C	Excellent	Moderate
Advanced PE	Polyethylene, 50% reticulated	All fluids	16	-40°C	+95°C	Good	Excellent
FEP	Fluoropolymer: fluorinated ethylene-propylene	All fluids	28	-40°C	+150°C	Good	Excellent
PFA	Fluoropolymer: high purity and coloured perfluoroalkoxy FDA	All fluids	36	-196°C	+260°C	Excellent	Excellent
Antistatic PFA	Fluoropolymer: perfluoroalkoxy filled with conducting particles	All fluids	36	-196°C	+260°C	Excellent	Good
Self-Fastening NBR	NBR with polyamide braid	Compressed air, coolants	16	-20°C	+100°C	Excellent	Good
Braided PU	Polyurethane with polyester braid	Compressed air, industrial fluids	15	-40°C	+75°C	Excellent	Good

Function Fittings

Polymer Flow Regulators	Technical polymer/nickel-plated brass	Compressed air	10	0°C	+70°C	Good	Moderate
Metal Flow Regulators	Treated brass/nickel-plated brass	Compressed air	10	-25°C*	+70°C	Excellent	Moderate

*depending on the model

This table is not exhaustive; you will find additional technical information in the various chapters of this catalogue which will enable you to select the product you need.

Function Fittings (continued)	Materials	Fluids	Maximum Pressure (bar)	Temperature		Performance in Aggressive Environments	
				Min.	Max.	Mechanical	Chemical
Stainless Steel Flow Regulators	316L stainless steel	Compressed air	40	-15°C	+120°C	Excellent	Excellent
Blocking Fittings	Nickel-plated brass	Compressed air	10	-20°C	+70°C	Excellent	Good
Piloted Non-Return Valve	Technical polymer/nickel-plated brass	Compressed air	10	-5°C	+60°C	Good	Moderate
Non-Return Fitting	Technical polymer/nickel-plated brass	Compressed air	10	0°C	+70°C	Good	Moderate
LIQUIfit® Non-Return Fitting	POM	Compressed air, drinkable water, treated water, beverages	10	0°C	+0°C	Good	Moderate
Silencers	Polymer, sintered bronze, nickel-plated brass, 316L stainless steel	Compressed air	12	-20°C	+180°C	Good	Moderate

*depending on the model

Compression Fittings

Brass Fittings	Brass	Compressed air, industrial fluids	550 (depending on the type of tubing used)	-60°C	+250°C	Excellent	Good
Stainless Steel Fittings	316L stainless steel	All fluids	400 (80 bar in aggressive environment)	-60°C	+250°C	Excellent	Excellent
PL Spigot Fittings	Nickel-plated brass	Compressed air, industrial fluids	40 (depending on the type of nut used)	-40°C	+100°C	Good	Good

Industrial Valves

Universal and Customised Series Ball Valves	Nickel-plated brass	Compressed air, industrial fluids	40	-40°C*	+100°C	Excellent	Good
Mini Series Ball Valves	Technical polymer/nickel-plated brass	Compressed air	10	-20°C	+80°C	Good	Moderate
DVGW Series Ball Valves	Nickel-plated brass	Gas, water	40	-40°C	+170°C	Excellent	Good
LIQUIfit® Ball Valves	Polypropylene	Drinking water, treated water, beverages	10	-15°C	+100°C	Moderate	Good
Standard Series Ball Valves	Nickel- or chromium-plated brass	All industrial fluids	30	-20°C	+130°C	Excellent	Good
Stainless Steel Series Ball Valves	316L stainless steel	All fluids	65	-20°C	+150°C	Excellent	Excellent
Axial Valves	Nickel-plated brass	Compressed air	10	-20°C	+135°C	Excellent	Good

*depending on the model

Industrial Blowguns

Polymer	Technical polymer	Compressed air	10	-20°C	+50°C	Good	Moderate
Metal	Aluminium or nickel-plated brass	Industrial fluids	20	-20°C	+100°C	Excellent	Good

Quick-Acting Couplers

C 9000 Safety Couplers	Technical polymer	Compressed air	16	-20°C	+60°C	Good	Moderate
Metal Quick-Acting Couplers	Nickel-plated brass	Compressed air, compatible fluids	20	-20°C	+100°C	Excellent	Good
Coupleurs séries mini, médium et maxi	Nickel-plated brass	Water and air	20	-20°C	+100°C	Excellent	Good

Adaptors and Manifolds

Brass Adaptors with sealing washer	Brass	Compressed air	200	-20°C	+100°C	Good	Moderate
Brass Adaptors without sealing washer	Brass	Compressed air	200	-40°C	+150°C	Good	Moderate
Nickel-Plated Brass Adaptors	Nickel-plated brass	Compressed air	60	-10°C	+80°C	Good	Moderate
Stainless Steel Adaptors	316L stainless steel	All fluids	200	-20°C	+180°C	Excellent	Excellent
Manifolds	Anodised aluminium, brass	Compressed air	20	-10°C	+80°C	Excellent	Good

Part Number Identification

The part numbers used for our product ranges are coded in such a way as to make it easy to identify any particular item. Detailed explanations of these part numbers can be found in the corresponding chapters.

Fittings and Valves

The part numbers are selected using a technical mnemonic code.

Each fitting and valve is identified by:

- model series (4 digits)
- nominal diameter (2 digits)

- thread or 2nd nominal diameter (2 digits)
- a suffix, if applicable

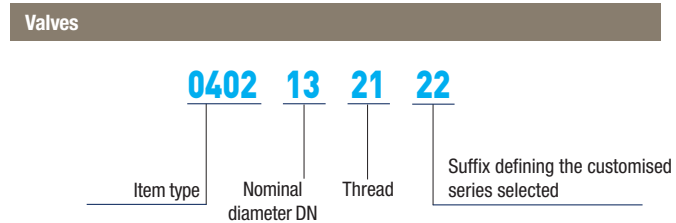
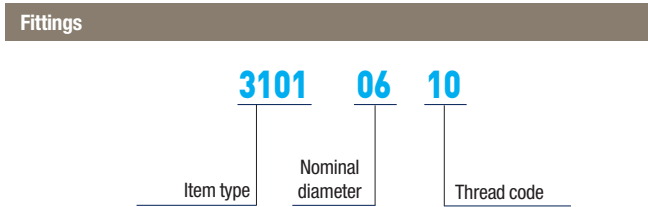

Nominal diameter code: equates to the outside diameter of the tube.
Thread code: see tables page 12.

Nominal diameter code: equates to the bore diameter of the valve.
Thread code: see tables page 12.

When the product does not have a thread, the code used is: 00.

Technical Tubing and Hose

The part numbers are selected using a technical mnemonic code.

Each tube and hose is identified by:

- model series (4 digits and a letter)
- nominal diameter (2 digits)

- colour (2 digits)
- inside diameter, if applicable

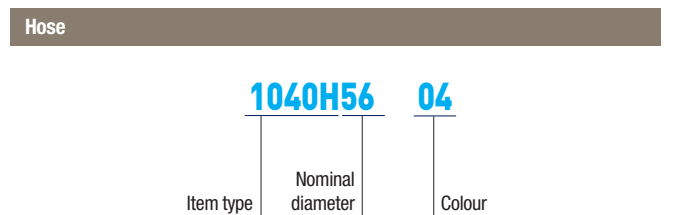
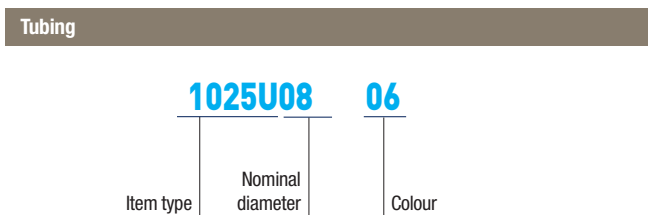

Nominal diameter code: equates to the outside diameter.
Colour code: see table below.

Nominal diameter code: equates to the inside diameter code.
Colour code: see table below.

00 = □ 01 = ■ 02 = ■ 03 = ■ 04 = ■ 05 = ■ 06 = ■ 07 = ■ 08 = □

For other colours, refer to chapter "Technical Tubing and Hose".

Push-In Fittings

Chapter 1

LF 3000®/LF 3200

LIQUIfit®

LF 6270, Optic Fibre

Prestomatic

LF 3600/LF 6100

LF 3800/LF 3900



Cartridges and Customised Products

Chapter 2

Polymer: Carstick® & Quick Fitting

Metal: LF Cartridges & FTL Fittings

Customised Products



Technical Tubing and Hose

Chapter 3

Flexible Calibrated Tubing

Calibrated Multi-Tubing

Recoil Tubing and Hose

Calibrated Braided Hose

Accessories



Function Fittings

Chapter 4

Flow Control Regulators

Piloted Function Fittings

Non-Return Valves & LIQUIfit®

Pressure Fittings

Other Function Fittings

Silencers



Compression Fittings

Chapter 5

Brass Compression Fittings

Stainless Steel Compression Fittings

PL Nickel-Plated Brass Spigot Fittings



Industrial Valves

Chapter 6

Ball Valves & LIQUIfit®

Needle & Butterfly Valves

Axial Valves



Industrial Blowguns

Chapter 7

Polymer

Metal

Kits



Quick-Acting Couplers

Chapter 8

Polymer: C 9000 Safety

Metal: Nickel-Plated Brass and Steel



Adaptors and Manifolds

Chapter 9

Adaptors: Brass, Nickel-Plated Brass, Stainless Steel

Manifolds



Push-In Fittings

LF 3000[®] and LF 3200

LIQUIfit[®]

LF 6270, Optic Fibre

Prestomatic

LF 3600 and LF 6100

LF 3800/LF 3900



Principle and Advantages of the Push-In Fitting

The **push-in fitting** is the most intuitive way of connecting tubes to a fitting in order to create a fluid distribution network. Thanks to its **quick installation**, versatility and **exceptional lifespan**, the push-in fitting contributes to improving machine efficiency. Moreover, the advanced patented design of the LF 3000® contributes to reducing **total cost of use**.

Connection

- Manual connection and disconnection without the use of tools
- Release button available in 5 colours, to identify different circuits

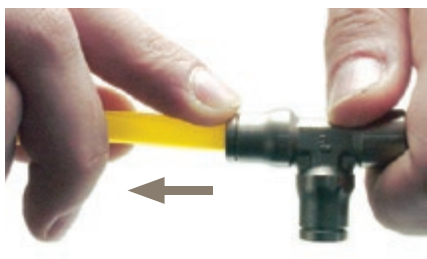
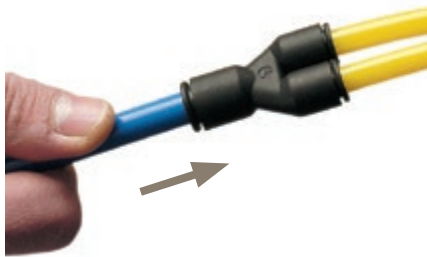

Assembly

All straight connectors are fitted with an internal hexagon for ease of assembly with the use of an Allen spanner. This enables assembly in restricted spaces.

Threads

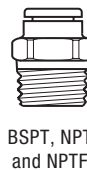

Close Porting Assembly

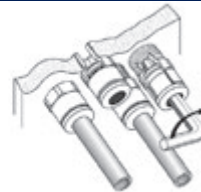

Our fittings are designed for internal (above) or external assembly.

Sealing and 100 % Leak-Tested

The quality of the sealing material, selected specifically for the application, ensures excellent longevity of the fitting. In this way, Parker Legris offers the best return on investment on the market.

Quality of Design

- Unique and patented sealing technology
- Rigorous selection of materials:
NBR: ideally suited for compressed air
EPDM: perfectly suited for food and beverage
FKM: all fluids and high temperatures
- 100 % leak-tested in the production process

Benefits of Use

- The lowest leak rate on the market, whatever the temperature and length of use
- Perfectly suited to primary vacuum
- Full bore for optimum flow
- Optimum gripping of tube guaranteed

Gripping Ring Technology

- Ideal for polymer tubing, even for soft tubing
- Excellent tube guidance
- No tube movement under pressure
- Very compact solution

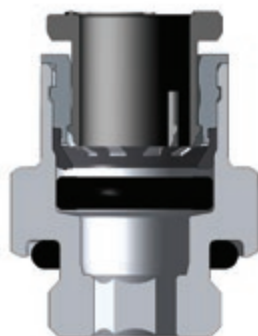

Gripping with Collet

- For polymer and grooved metal tubing (groove drawings available on request)
- Resistant to high pressure, excellent lifespan
- Robust solution for harsh environments

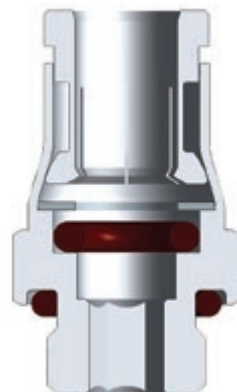

Gripping with Reversed Collet

- For rigid polymer and grooved metal tubing
- Resistant to high pressure
- Excellent durability
- Optimum sealing

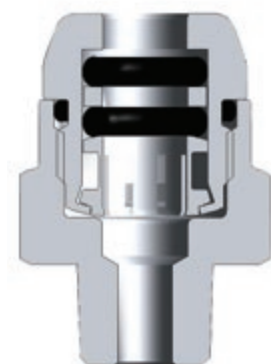

Push-In Fittings

LF 3000® Push-In Fittings

(P. 1-4)



Fluids: compressed air

Materials: technical polymer, nickel-plated brass, NBR

Pressure: 20 bar

Temperature: -20°C to +80°C

Ø metric: 3 mm to 16 mm

Ø inch: 1/8" to 1/2"

LF 3200 Push-In Fittings (3 mm)

(P. 1-39)



Fluids: compressed air, non-corrosive fluids

Materials: chemical nickel-plated brass, NBR

Pressure: 20 bar

Temperature: -15°C to +80°C

Ø metric: 3 mm

LIQUIfit® Push-In Fittings

(P. 1-44)



Fluids: water, beverages, coolants, inert gases

Materials: biopolymer, EPDM, nickel-plated brass or stainless steel

Pressure: 16 bar

Temperature: -10°C to +95°C

Ø metric: 4 mm to 12 mm

Ø inch: 5/32" to 1/2"

LF 6270 Connectors for Optic Fibre Networks

(P. 1-73)



Fluids: compressed air, industrial water

Materials: technical polymer, NBR

Pressure: 25 bar

Temperature: -20°C to +80°C

Ø metric: 5 mm to 14 mm

Prestomatic Push-In Fittings

(P. 1-83)



Fluids: compressed air

Materials: technical polymer, brass, NBR

Pressure: 25 bar

Temperature: -50°C to +100°C

Ø metric: 6 mm to 16 mm

Braking System Adaptors

(P. 1-90)



Fluids: compressed air

Materials: brass, NBR

Pressure: 25 bar

Temperature: -40°C to +100°C

LF 3600 Push-In Fittings

(P. 1-95)



Fluids: compressed air, slightly corrosive industrial fluids

Materials: high phosphorus nickel-plated brass, FKM

Pressure: 30 bar

Temperature: -25°C to +150°C

Ø metric: 4 mm to 14 mm

LF 6100 Push-In Fittings

(P. 1-107)



Fluids: compressed air, oil, water

Materials: brass, NBR

Pressure: 60 bar

Temperature: -40°C to +120°C

Ø metric: 4 mm to 10 mm

LF 3800/LF 3900 Push-In Fittings

(P. 1-113)



Fluids: industrial fluids, chemicals, medical fluids, beverages

Materials: stainless steel, FKM

Pressure: 30 bar

Temperature: -25°C to +150°C

Ø metric: 4 mm to 12 mm

Ø inch: 3/16" to 1/2"

For more details on these ranges, you will find a selection guide in the "Introduction" section of this catalogue.

LF 3000® Push-In Fittings Range

Stud Fittings

Straights

3175
BSPT/NPT
Page 1-7



3101
BSPP/Metric
Page 1-8



3181
Metric
Page 1-8



3114
BSPP/Metric
Page 1-9



3121
BSPT/NPT
Page 1-9



3131
BSPP/Metric
Page 1-10



Straights - Inch

3175
NPT/BSPT
Page 1-7/8



3121
NPT
Page 1-9



Elbows

3109
BSPT/NPT
Page 1-10



3199
BSPP/Metric
Page 1-11



3192
BSPP
Page 1-12



3129
BSPT
Page 1-12



3169
BSPP/Metric
Page 1-13



3113
BSPT
Page 1-13



3133
BSPP/Metric
Page 1-13



Elbows - Inch

3109
NPT/BSPT
Page 1-11



Tees

3108
BSPT
Page 1-14



3198
BSPP/Metric
Page 1-14



3103
BSPT
Page 1-14



3193
BSPP/Metric
Page 1-15



Y

3148
BSPT
Page 1-15



3158
BSPP/Metric
Page 1-15



3112
BSPT
Page 1-16



3132
BSPP
Page 1-16



Cartridge

3100
Carstick®
Page 1-16



Cartridge - Inch

3100
Carstick®
Page 1-16



Tube-to-Tube Fittings

Straight

3106
Page 1-17



Straight - Inch

3106
Page 1-17



Elbow

3102
Page 1-17



Elbow - Inch

3102
Page 1-17



Tee

3104
Page 1-18



Tee - Inch

3104
Page 1-18



Y

3140
Page 1-18



Cross

3107
Page 1-19



Bulkhead Connector Fittings

Straights

3116
Page 1-20



3146
Page 1-20



3136
Page 1-20



Elbow

3139
Page 1-20



Multiple Fittings

Y

3144
Page 1-21



Tee

3304
Page 1-21



Elbow

3306
Page 1-21



Manifold

3310
Page 1-21



LF 3000® Push-In Fittings Range

Plug-In Fittings and Accessories

Elbows

3182
Page 1-22

3184
Page 1-22

3180
Page 1-22

3182
Page 1-22



Elbows - Inch

3182
Page 1-22

Tees

3183
Page 1-23

3188
Page 1-23

Y

3142
Page 1-23

3143
Page 1-23



Accessories

3120
Page 1-24

3166
Page 1-24

3168
Page 1-24

3126
Page 1-25

3122
Page 1-25

3151
Page 1-25

3166
Page 1-24

3168
Page 1-24

3126
Page 1-25



Accessories - Inch

Banjo Fittings

Banjo Fittings

3118
BSPP/Metric
Page 1-27

3018
BSPT
Page 1-27

3124
BSPP/Metric
Page 1-27

3149
BSPP/Metric
Page 1-27

3119
BSPP/Metric
Page 1-27



Modular Banjo Fittings

3538
Single Body
Page 1-28

3539
Double Body
Page 1-28

3549
Y Body
Page 1-28

3527
BSPP/Metric
Page 1-29

3528
BSPP/Metric
Page 1-29

3529
BSPP
Page 1-29

3524
BSPP/Metric
Page 1-29



Multi-Connectors

3300
Page 1-31

3320
Page 1-31

3321
Page 1-31

3329
Page 1-31

3379
Page 1-32

3381
Page 1-32



Self-Sealing and Oscillating Fittings

Self-Sealing Fittings

3391
BSPP
Page 1-35

3091
BSPT
Page 1-35

3160
Page 1-35

3159
BSPT
Page 1-35

3189
BSPP/Metric
Page 1-35



Oscillating Fittings

Accessories for Push-In Fittings

3130
Page 1-37

Clip
Page 1-37

3000 70
Page 1-37

3110
Page 1-37

0178
BSPP/Metric
Page 1-37

0222
BSPP/Metric
Page 1-37



LF 3000® Push-In Fittings

The LF 3000® range, with its wide variety of shapes and configurations, allows you to find **the perfect product to meet your needs** and thus **optimise the use** of your equipment.

Product Advantages

Extreme Durability for Optimum Profitability

40 years of expertise
 Conforms to ISO 14743
 Ideal for vacuum or pressure applications
 Tried-and-tested longevity according to DI 2006/42/CE requirements
 Materials with high resistance
 Durability of product and equipment

Maximum Machine Efficiency

100% leak-tested in production
 Full bore for optimum flow
 Tube fixed during connection, preventing leakage
 Excellent vacuum performance thanks to the patented sealing technology

Productivity & Maintenance Improvement

Compact and aesthetic design: reduced dimensions for space-saving
 Lightweight: reduced energy consumption of operating systems
 Parallel threaded fitting with a patented captive O-ring seal
 Maximum flexibility due to the wide product range
 Date coding to guarantee quality and traceability
 Automatic sealing guaranteed, in both static and dynamic applications



Robotics
 Automotive Process
 Pneumatics
 Semi-Conductors
 Textile
 Packaging
 Vacuum

Applications

Technical Characteristics

Compatible Fluids	Compressed air Other fluids: please consult us
Working Pressure	Vacuum to 20 bar
Working Temperature	-20°C to +80°C

Tightening Torque (daN.m)	Threads								
	M3 x0.5	M5 x0.8	M7 x1	M10 x1	M12 x1.5	G1/8	G1/4	G3/8	G1/2
	0.06	0.16	0.8	0.8	1.1	0.8	1.2	3	3.5

Reliable performance is dependent upon the type of fluid conveyed, component materials and tubing being used.
 Use is guaranteed with a vacuum of 755 mm Hg (99% vacuum).

Component Materials

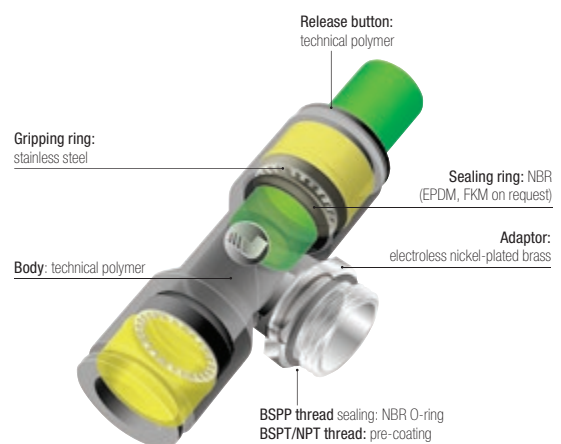

Silicone-free

Regulations

DI: 2006/42/EC test according to ISO 19973-5.
 ISO 14743: Pneumatic fluid power, push-in connectors for thermoplastic tubes

DI: 97/23/EC (PED)
 DI: 2002/95/EC (RoHS), 2011/65/EC
 DI: 1907/2006 (REACH)

Stud Fittings

3175 Stud Fitting, Male BSPT Thread

Nickel-plated brass, NBR

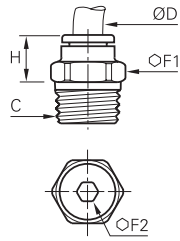

ØD	C		F1	F2	H	Kg
4	R1/8	3175 04 10	10	3	9.5	0.005
	R1/4	3175 04 13	14	3	6.5	0.012
	R3/8	3175 04 17	17	3	8	0.024
6	R1/8	3175 06 10	10	4	11.5	0.005
	R1/4	3175 06 13	14	4	8.5	0.011
	R3/8	3175 06 17	17	4	8.5	0.022
8	R1/2	3175 06 21	21	4	9	0.043
	R1/8	3175 08 10	13	5	20	0.011
	R1/4	3175 08 13	14	6	17	0.014
	R3/8	3175 08 17	17	6	13	0.021
10	R1/2	3175 08 21	21	6	12	0.040
	R1/8	3175 10 10	16	5	22.5	0.017
	R1/4	3175 10 13	16	7	20	0.017
	R3/8	3175 10 17	17	8	16.5	0.019
12	R1/2	3175 10 21	21	8	14	0.036
	R1/4	3175 12 13	19	7	26.5	0.029
	R3/8	3175 12 17	19	9	24	0.028
14	R1/2	3175 12 21	21	10	19.5	0.036
	R3/8	3175 14 17	22	9	28.5	0.044
16	R1/2	3175 14 21	24	10	23.5	0.047
	R3/8	3175 16 17	27	9	32.5	0.068
	R1/2	3175 16 21	27	12	32.5	0.079

Pre-coated thread

3175 Stud Fitting, Male NPT Thread

Nickel-plated brass, NBR

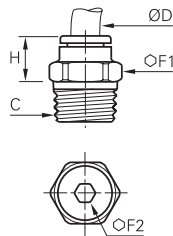

ØD	C		F1	F2	H	Kg
6	NPT1/8	3175 06 11	11	4	11.5	0.006
	NPT1/4	3175 06 14	14	4	8.5	0.013
10	NPT1/4	3175 10 14	16	7	20	0.018
	NPT3/8	3175 10 18	18	8	16.5	0.023
12	NPT1/2	3175 10 22	22	8	14	0.037
	NPT3/8	3175 12 18	19	9	24	0.030
	NPT1/2	3175 12 22	22	10	19.5	0.037

Pre-coated thread

3175 Stud Fitting, Male NPT Thread

Inch

Nickel-plated brass, NBR

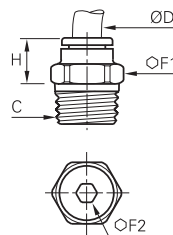

ØD	C		F1	F2	H	Kg
1/8	NPT1/8	3175 53 11	11	2	7.2	0.006
	NPT1/4	3175 53 14	14	2	8	0.015
1/4	NPT1/8	3175 56 11	11	4	11.9	0.006
	NPT1/4	3175 56 14	14	4	9.4	0.013
	NPT3/8	3175 56 18	18	5	7.6	0.024
3/8	NPT1/8	3175 60 11	16	4	22.7	0.019
	NPT1/4	3175 60 14	16	7	20.5	0.019
1/2	NPT3/8	3175 60 18	18	7	17.5	0.026
	NPT3/8	3175 62 18	22	9.5	25.9	0.047
	NPT1/2	3175 62 22	24	9.5	22.1	0.064

Pre-coated thread

Other products are available upon request; please do not hesitate to consult us.

Stud Fittings

3175 Stud Fitting, Male BSPT Thread

Inch

Nickel-plated brass, NBR

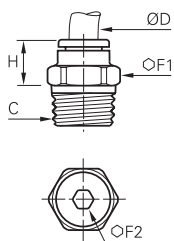

ØD	C		F1	F2	H	Kg
1/8	R1/8	3175 53 10	11	3	8.5	0.005
	R1/8	3175 55 10	11.1	3.2	15.5	0.009
3/16	R1/4	3175 55 13	14.3	4	15	0.020
	R1/8	3175 56 10	11	4	12	0.006
1/4	R1/4	3175 56 13	14	4	9.5	0.021
	R1/4	3175 60 13	18	5	7.5	0.018
3/8	R3/8	3175 60 17	13	5	20	0.019
	R1/2	3175 60 21	14	6	16.8	0.061
1/2	R1/4	3175 62 13	22	6	26.9	0.044
	R3/8	3175 62 17	22	7	25.9	0.048
	R1/2	3175 62 21	24	7	20.5	0.049

Pre-coated thread

3101 Stud Fitting, Male BSPP and Metric Thread

Nickel-plated brass, NBR

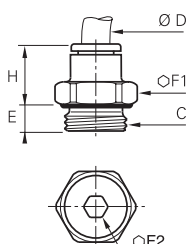

ØD	C		E	F1	F2	H	Kg
3	M3x0.5	3101 03 09*	2.5	8	-	12.5	0.003
	M5x0.8	3101 03 19	3.5	8	2.5	12.5	0.004
	M3x0.5	3101 04 09*	2.5	8	-	14.5	0.003
	M5x0.8	3101 04 19	3	9	2.5	14	0.004
4	M7x1	3101 04 55	5	10	2.5	14	0.004
	G1/8	3101 04 10	5	13	3	11.5	0.007
	G1/4	3101 04 13	5.5	16	3	10.5	0.011
	M5x0.8	3101 06 19	3.5	11	2.5	16	0.005
	M7x1	3101 06 55	5	10	3	16	0.006
	M10x1	3101 06 60	5	13	4	13	0.007
6	M12x1.5	3101 06 67	5.5	15	4	13	0.009
	G1/8	3101 06 10	5	13	4	13	0.007
	G1/4	3101 06 13	5.5	16	4	12.5	0.010
	G3/8	3101 06 17	5.5	20	4	13	0.020
	G1/2	3101 06 21	7.5	24	4	20	0.040
	M10x1	3101 08 60	5	13	5	21	0.011
8	M12x1.5	3101 08 67	5.5	15	5	21	0.015
	G1/8	3101 08 10	4.5	13	5	20.5	0.011
	G1/4	3101 08 13	5.5	16	6	19.5	0.016
	G3/8	3101 08 17	5.5	20	6	18	0.022
	G1/2	3101 08 21	7.5	24	6	16.5	0.039
	G1/4	3101 10 13	5.5	16	7	23	0.018
10	G3/8	3101 10 17	5.5	20	8	19.5	0.021
	G1/2	3101 10 21	7.5	24	8	18.5	0.033
12	G1/4	3101 12 13	5.5	19	7	27.5	0.027
	G3/8	3101 12 17	5.5	20	9	27	0.029
14	G1/2	3101 12 21	7	24	11	22.5	0.035
	G3/8	3101 14 17	5.5	22	9	29.5	0.041
16	G1/2	3101 14 21	7	24	11	28	0.046
	G3/8	3101 16 17	7.5	27	9	32.5	0.061
	G1/2	3101 16 21	9	27	12	32.5	0.066

*Bi-material O ring seal

3181 Stud Fitting Round Body, Male Metric Thread

Nickel-plated brass, NBR

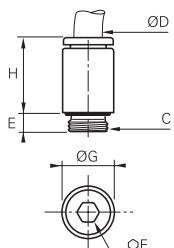

ØD	C		E	F	G	H	Kg
4	M5x0.8	3181 04 19	3.5	2.5	8.5	14.5	0.003
	M7x1	3181 04 55	5	3	10	14	0.004
6	M5x0.8	3181 06 19	3.5	2.5	11	16.5	0.005
	M7x1	3181 06 55	5	3	10	16	0.005

The internal hexagon and circular external shape ensure that model 3181 provides highly compact assembly.

They can be easily installed with an Allen key without the need of a spanner.

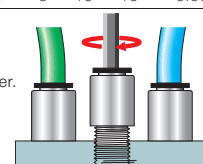

Stud Fittings

3114 Stud Fitting, Female BSPP and Metric Thread

Nickel-plated brass, NBR

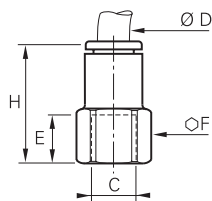

ØD	C		E	F	H	Kg
4	M5x0.8	3114 04 19	6.5	8	19.5	0.005
	G1/8	3114 04 10	9.5	13	22.5	0.009
	G1/4	3114 04 13	13.5	16	26.5	0.015
6	G1/8	3114 06 10	9.5	13	24.5	0.011
	G1/4	3114 06 13	13.5	16	28.5	0.016
8	G1/8	3114 08 10	9.5	13	29	0.015
	G1/4	3114 08 13	13.5	16	33	0.021
	G3/8	3114 08 17	14	19	34	0.025
10	G1/4	3114 10 13	13.5	16	36	0.027
	G3/8	3114 10 17	14	19	36	0.027
12	G1/2	3114 10 21	19.5	24	41.5	0.048
	G3/8	3114 12 17	14	19	40	0.033
14	G1/2	3114 12 21	19.5	24	45.5	0.053
	G3/8	3114 14 17	14	22	42.5	0.057
16	G1/2	3114 16 21	15	27	49	0.096

3121 Stud Standpipe, Male BSPT Thread

Technical polymer, nickel-plated brass

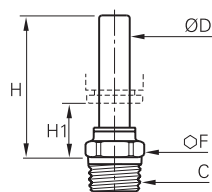

ØD	C		F	H	H1	Kg
4	R1/8	3121 04 10	10	26	14	0.005
	R1/4	3121 04 13	14	26.5	14.5	0.014
6	R1/8	3121 06 10	10	28	14	0.005
	R1/4	3121 06 13	14	28.5	14.5	0.014
8	R1/8	3121 08 10	10	29.5	11	0.005
	R1/4	3121 08 13	14	28.5	10	0.012
	R3/8	3121 08 17	17	28.5	10	0.016
10	R1/4	3121 10 13	15	36	15.5	0.012
	R3/8	3121 10 17	17	36	15.5	0.017
	R1/2	3121 10 21	21	36	15.5	0.028
12	R3/8	3121 12 17	17	36.5	12	0.018
	R1/2	3121 12 21	21	36.5	12	0.030
14	R1/2	3121 14 21	21	41	13.5	0.042

Pre-coated thread

3121 Stud Standpipe, Male NPT Thread

Technical polymer, nickel-plated brass

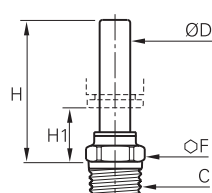

ØD	C		F	H	H1	Kg
4	NPT1/8	3121 04 11	11	25.9	14.5	0.007
	NPT1/4	3121 04 14	14	26.4	15	0.017
8	NPT1/8	3121 08 11	11	29.5	10.9	0.008
	NPT1/4	3121 08 14	14	28.4	9.9	0.014

Pre-coated thread

3121 Stud Standpipe, Male NPT Thread

Inch

Technical polymer, nickel-plated brass

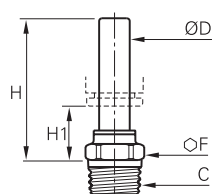

ØD	C		F	H	H1	Kg
1/4	NPT1/8	3121 56 11	11	30	15.5	0.001
	NPT1/4	3121 56 14	14	28.4	14.5	0.001
3/8	NPT1/8	3121 60 11	15	44.4	16.5	0.013
	NPT1/4	3121 60 14	15	36.1	17	0.014
1/2	NPT3/8	3121 60 18	18	36.1	15.5	0.023
	NPT3/8	3121 62 18	17	36.6	9.4	0.026
	NPT1/2	3121 62 22	21	37.1	9.9	0.046

Pre-coated

5/32" (4 mm) and 5/16" (8 mm) are also available.

Stud Fittings

3131 Stud Standpipe, Male BSPP and Metric Thread

Technical polymer, nickel-plated brass, NBR

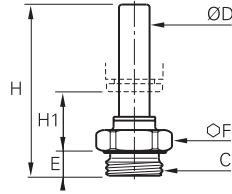

ØD	C		E	F	H	H1	Kg
4	M5x0.8	3131 04 19	3.5	8	31	16	0.002
	G1/8	3131 04 10	5	13	30	13.5	0.005
	G1/4	3131 04 13	5.5	16	31	13.5	0.010
6	G1/8	3131 06 10	5	13	32	13.5	0.005
	G1/4	3131 06 13	5.5	16	33	13.5	0.010
	G1/8	3131 08 10	5	13	35.5	12.5	0.008
8	G1/4	3131 08 13	5.5	16	34.5	10.5	0.010
	G3/8	3131 08 17	5.5	20	34.5	10.5	0.015
	G1/4	3131 10 13	5.5	16	43.5	17.5	0.012
10	G3/8	3131 10 17	5.5	20	41.5	15.5	0.015
	G1/2	3131 10 21	7.5	24	41.5	15.5	0.024
12	G3/8	3131 12 17	5.5	20	42	12	0.015
	G1/2	3131 12 21	7	24	43.5	12	0.025
14	G3/8	3131 14 17	5.5	20	46.5	14	0.015
	G1/2	3131 14 21	7	24	48	13.5	0.025

3109 Stud Elbow, Male BSPT Thread

Technical polymer, nickel-plated brass, NBR

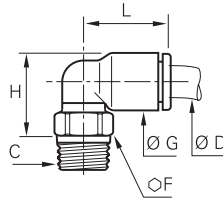

ØD	C		F	G	H	L	Kg
4	R1/8	3109 04 10	10	8.5	13.5	14	0.006
	R1/4	3109 04 13	14	8.5	14	14	0.015
	R3/8	3109 04 17	17	8.5	13.5	14	0.018
6	R1/8	3109 06 10	10	10.5	15.5	16	0.006
	R1/4	3109 06 13	14	10.5	16	16	0.015
	R3/8	3109 06 17	17	10.5	16	16	0.019
8	R1/2	3109 06 21	21	10.5	16.5	16	0.034
	R1/8	3109 08 10	10	13.5	19	23	0.007
	R1/4	3109 08 13	14	13.5	18	23	0.014
10	R3/8	3109 08 17	17	13.5	18	23	0.018
	R1/2	3109 08 21	21	13.5	19.5	23	0.032
	R1/8	3109 10 10	15	16	23	26.5	0.012
12	R1/4	3109 10 13	15	16	22	26.5	0.014
	R3/8	3109 10 17	17	16	22	26.5	0.020
	R1/2	3109 10 21	21	16	22	26.5	0.032
14	R1/4	3109 12 13	15	19	25	31	0.016
	R3/8	3109 12 17	17	19	25	31	0.022
	R1/2	3109 12 21	21	19	25	31	0.035
16	R3/8	3109 14 17	20	22	30.5	35.5	0.031
	R1/2	3109 14 21	24	22	28.5	35.5	0.041
	R3/8	3109 16 17	27	27	53	39	0.106
	R1/2	3109 16 21	27	27	53	39	0.104

Pre-coated thread
The body swivels for positioning purposes.

3109 Stud Elbow, Male NPT Thread

Technical polymer, nickel-plated brass, NBR

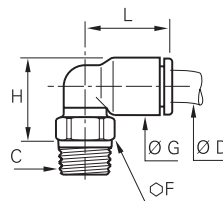

ØD	C		F	G	H	L	Kg
4	NPT1/8	3109 04 11	11	8.4	13.5	14	0.007
	NPT1/4	3109 04 14	14	8.4	14	14	0.016
6	NPT1/8	3109 06 11	11	10.5	15.5	16	0.007
	NPT1/4	3109 06 14	14	10.5	16	16	0.016
8	NPT1/8	3109 08 11	11	13.5	19	23.1	0.009
	NPT1/4	3109 08 14	14	13.5	18	23.1	0.015
	NPT1/4	3109 10 14	15	16	23	26.5	0.017
10	NPT3/8	3109 10 18	18	16	22	26.5	0.023
	NPT1/2	3109 10 22	22	16	23	26.5	0.045
12	NPT3/8	3109 12 18	18	19	25	31	0.027
	NPT1/2	3109 12 22	22	19	26	31	0.033

Pre-coated thread
The body swivels for positioning purposes.

Stud Fittings

3109 Stud Elbow, Male NPT Thread

Inch

Technical polymer, nickel-plated brass, NBR

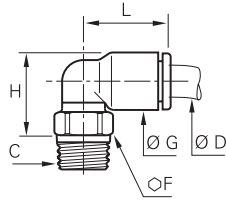

ØD	C		F	G	H	L	Kg
1/8	NPT1/8	3109 53 11	11	8.5	13.5	14.5	0.007
	NPT1/4	3109 53 14	14	8.5	14	14.5	0.015
1/4	NPT1/8	3109 56 11	11	10.9	17	18	0.008
	NPT1/4	3109 56 14	14	10.9	16	18	0.014
	NPT3/8	3109 56 18	18	10.9	16.5	18	0.020
3/8	NPT1/8	3109 60 11	15	16	23.1	27.4	0.013
	NPT1/4	3109 60 14	15	16	23.1	27.4	0.017
1/2	NPT3/8	3109 62 18	18	16	22.1	27.4	0.024
	NPT1/2	3109 62 22	20	22.1	31	35.1	0.033
			24	22.1	28.4	35.1	0.045

Pre-coated thread. The body swivels for positioning purposes.
5/32"(4 mm) and 5/16"(8 mm) are also available.

3109 Stud Elbow, Male BSPT Thread

Inch

Technical polymer, nickel-plated brass, NBR

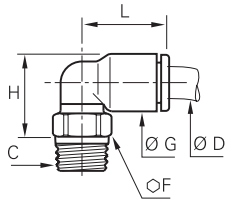

ØD	C		F	G	H	L	Kg
1/8	R1/8	3109 53 10	10	8.5	13.5	14.5	0.011
	R1/4	3109 55 10	11	10.9	17	21.6	0.010
3/16	R1/8	3109 55 10	14	8.4	14	14	0.016
	R1/4	3109 56 10	10	10.9	17	18	0.006
1/4	R1/4	3109 56 13	14	10.9	17	18	0.013
	R1/4	3109 60 13	15	16	22.1	26.4	0.016
3/8	R3/8	3109 60 17	17	16	22.1	26.4	0.054
	R1/4	3109 62 13	20	22.1	31	35.1	0.064
	R3/8	3109 62 17	20	22.1	31	35.1	0.067
1/2	R1/2	3109 62 21	24	22.1	28.4	35.1	0.046

Pre-coated thread. The body swivels for positioning purposes.
5/32"(4 mm) and 5/16"(8 mm) are also available.

3199 Stud Elbow, Male BSPP and Metric Thread

Technical polymer, nickel-plated brass, NBR

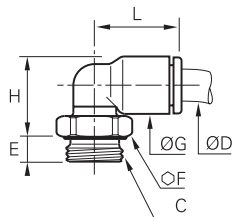

ØD	C		E	F	G	H	L	Kg
3	M3x0.5	3199 03 09	2.5	8	8.5	15	14.5	0.003
	M5x0.8	3199 03 19	3.5	8	8.5	13.5	14.5	0.003
	M3x0.5	3199 04 09*	2.5	8	8.5	15	14.5	0.002
	M5x0.8	3199 04 19	3.5	8	8.5	13.5	14	0.002
4	M7x1	3199 04 55	4.5	10	8.5	15	14	0.005
	G1/8	3199 04 10	5	13	8.5	13	14	0.006
	G1/4	3199 04 13	5.5	16	8.5	13	14	0.011
	M5x0.8	3199 06 19	3.5	8	10.5	15.5	16	0.003
	M7x1	3199 06 55	4.5	10	10.5	17.5	16	0.006
	M10x1	3199 06 60	5	13	10.5	15	14	0.006
6	M12x1.5	3199 06 67	5.5	15	10.5	15	16	0.009
	G1/8	3199 06 10	5	13	10.5	15	16	0.006
	G1/4	3199 06 13	5.5	16	10.5	15	16	0.011
	G3/8	3199 06 17	5.5	20	10.5	15.5	16	0.022
	G1/2	3199 06 21	7	24	10.5	16	16	0.028
	M10x1	3199 08 60	5	13	13.5	20.5	23	0.009
8	M12x1.5	3199 08 67	5.5	15	13.5	19.5	23	0.009
	G1/8	3199 08 10	4.5	13	13.5	20.5	23	0.009
	G1/4	3199 08 13	5.5	16	13.5	18.5	23	0.012
	G3/8	3199 08 17	5.5	20	13.5	18.5	23	0.017
	G1/2	3199 08 21	7	24	13.5	19	23	0.027
	G1/4	3199 10 13	5.5	16	16	23.5	26.5	0.014
10	G3/8	3199 10 17	5.5	20	16	22	26.5	0.017
	G1/2	3199 10 21	7.5	24	16	22	26.5	0.027
	G1/4	3199 12 13	5.5	16	19	26.5	31	0.016
12	G3/8	3199 12 17	5.5	20	19	25	31	0.019
	G1/2	3199 12 21	7	24	19	25	31	0.029
14	G3/8	3199 14 17	5.5	20	22	32.5	35.5	0.029
	G1/2	3199 14 21	7	24	22	27	35.5	0.028
16	G3/8	3199 16 17	7.5	27	27	54.5	39	0.101
	G1/2	3199 16 21	9	27	27	54.5	39	0.097

The body swivels for positioning purposes.
*Bi-material seal

Stud Fittings

3192 Stud Elbow, Female BSPP Thread

Technical polymer, nickel-plated brass, NBR

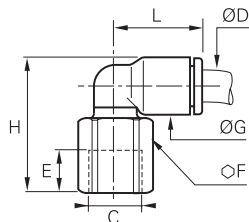

ØD	C		E	F	G	H	L	Kg
4	G1/8	3192 04 10	8.5	13	8.5	23	14	0.010
	G1/4	3192 04 13	11.5	16	8.5	27	14	0.017
6	G1/8	3192 06 10	8.5	13	10.5	25	16	0.010
	G1/4	3192 06 13	11.5	16	10.5	29	16	0.017
8	G1/8	3192 08 10	8.5	13	13.5	28	23	0.012
	G1/4	3192 08 13	11.5	16	13.5	32	23	0.020
	G3/8	3192 08 17	12	19	13.5	33	23	0.026
10	G1/4	3192 10 13	11	16	16	34.5	26.5	0.020
	G3/8	3192 10 17	12	19	16	35	26.5	0.024
	G1/2	3192 10 21	16	24	16	41	26.5	0.048
12	G1/4	3192 12 13	11	16	19	38	30.5	0.023
	G3/8	3192 12 17	12	19	19	38.5	30.5	0.027
	G1/2	3192 12 21	16	24	19	43.5	30.5	0.050

The body swivels for positioning purposes.

3129 Extended Stud Elbow, Male BSPT Thread

Technical polymer, nickel-plated brass, NBR

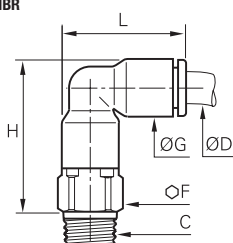

ØD	C		F	G	H	L	Kg
4	R1/8	3129 04 10	10	8.5	23	19	0.009
	R1/4	3129 04 13	14	8.5	23.5	19	0.018
6	R1/8	3129 06 10	10	10.5	27	22.5	0.010
	R1/4	3129 06 13	14	10.5	27.5	22.5	0.020
8	R1/8	3129 08 10	13	13.5	34.5	29.5	0.018
	R1/4	3129 08 13	14	13.5	32.5	29.5	0.022
	R3/8	3129 08 17	17	13.5	33	29.5	0.032
10	R1/4	3129 10 13	15	16	39.5	34.5	0.031
	R3/8	3129 10 17	17	16	39.5	34.5	0.042
	R1/2	3129 10 21	21	16	39.5	34.5	0.058
12	R1/4	3129 12 13	19	19	45.5	40.5	0.051
	R3/8	3129 12 17	19	19	45.5	40.5	0.047
	R1/2	3129 12 21	21	19	45.5	40.5	0.052
14	R3/8	3129 14 17	21	22	51.5	46.5	0.064
	R1/2	3129 14 21	21	22	51.5	46.5	0.070

Pre-coated thread

The body swivels for positioning purposes.

Parker Legris offers the solution to enable many types of configuration options.



Stud Fittings

3169 Extended Stud Elbow, Male BSPP and Metric Thread

Technical polymer, nickel-plated brass, NBR

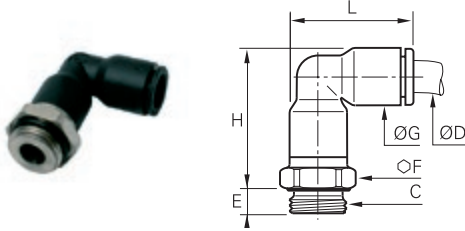

ØD	C		E	F	G	H	L	Kg
4	M5x0.8	3169 04 19	3.5	8	8.5	23	19	0.006
	M7x1	3169 04 55	4.5	10	8.5	22.5	19	0.008
	G1/8	3169 04 10	5	13	8.5	22.5	19	0.008
	G1/4	3169 04 13	5.5	16	8.5	22.5	19	0.013
6	M5x0.8	3169 06 19	3.5	10	10.5	27.5	23	0.008
	M7x1	3169 06 55	4.5	10	10.5	26	23	0.012
	G1/8	3169 06 10	5	13	10.5	27	23	0.011
	G1/4	3169 06 13	5.5	16	10.5	27	23	0.016
8	G1/8	3169 08 10	5	13	13.5	36	29.5	0.018
	G1/4	3169 08 13	5.5	16	13.5	33	29.5	0.020
	G3/8	3169 08 17	5.5	20	13.5	33	29.5	0.028
10	G1/4	3169 10 13	5.5	16	16	40.5	34.5	0.027
	G3/8	3169 10 17	5.5	20	16	40.5	34.5	0.036
	G1/2	3169 10 21	7.5	24	16	40.5	34.5	0.050
12	G1/4	3169 12 13	5.5	19	19	44.5	40.5	0.044
	G3/8	3169 12 17	5.5	20	19	42	40.5	0.038
	G1/2	3169 12 21	7.5	24	19	42	40.5	0.043
14	G3/8	3169 14 17	5.5	22	22	51	46.5	0.059
	G1/2	3169 14 21	7.5	24	22	48.5	46.5	0.063
16	G3/8	3169 16 17	7.5	27	27	82.5	52	0.220
	G1/2	3169 16 21	9	27	27	82.5	52	0.206

The body swivels for positioning purposes.

3113 45° Elbow, Male BSPT Thread

Technical polymer, nickel-plated brass, NBR

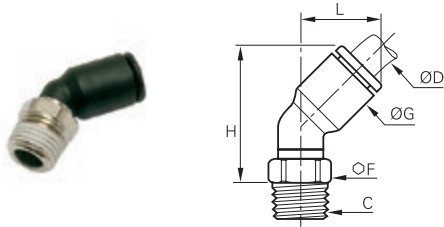

ØD	C		F	G	H	L	Kg
4	R1/8	3113 04 10	10	9	21	13	0.006
	R1/4	3113 06 10	10	11	24.5	14.5	0.006
6	R1/4	3113 06 13	14	11	25	14.5	0.015
	R1/8	3113 08 10	10	13.5	30	19.5	0.007
8	R1/4	3113 08 13	14	13.5	28.5	19.5	0.014
	R3/8	3113 08 17	17	13.5	28.5	19.5	0.018
10	R1/4	3113 10 13	15	16	33.5	23	0.014
	R3/8	3113 10 17	17	16	33.5	23	0.019
	R1/2	3113 10 21	21	16	34	23	0.032
12	R1/4	3113 12 13	15	19	39	26	0.016
	R3/8	3113 12 17	17	19	39	26	0.022
	R1/2	3113 12 21	21	19	39	26	0.034

Pre-coated thread
The body swivels for positioning purposes.
This model prevents distortion of the tube.

3133 45° Elbow, Male BSPP and Metric Thread

Technical polymer, nickel-plated brass, NBR

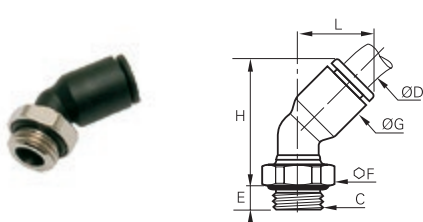

ØD	C		E	F	G	H	L	Kg
4	M5x0.8	3133 04 19	3.5	8	9	23	13	0.003
	G1/8	3133 04 10	4.5	13	9	20.5	13	0.006
6	M5x0.8	3133 06 19	3.5	8	11	28	14.5	0.003
	G1/8	3133 06 10	4.5	13	11	24	14.5	0.006
8	G1/4	3133 06 13	5.5	16	11	24	14.5	0.011
	G1/8	3133 08 10	4.5	13	13.5	31	19.5	0.009
	G1/4	3133 08 13	5.5	16	13.5	29	19.5	0.012
10	G3/8	3133 08 17	5.5	20	13.5	29	19.5	0.017
	G1/4	3133 10 13	5.5	16	16	35	23	0.014
	G3/8	3133 10 17	5.5	20	16	33.5	23	0.017
12	G1/2	3133 10 21	7	24	16	33.5	23	0.026
	G1/4	3133 12 13	5.5	16	19	40.5	26	0.016
	G3/8	3133 12 17	5.5	20	19	39	26	0.019
	G1/2	3133 12 21	7	24	19	39	26	0.028

The body swivels for positioning purposes.
This model prevents distortion of the tube.

Stud Fittings

3108 Stud Branch Tee, Male BSPT Thread

Technical polymer, nickel-plated brass, NBR

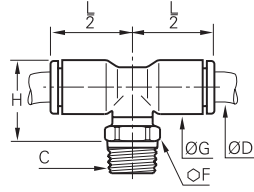

ØD	C		F	G	H	L/2	Kg
4	R1/8	3108 04 10	10	8.5	15.5	14	0.006
	R1/4	3108 04 13	14	8.5	16	14	0.015
6	R1/8	3108 06 10	10	10.5	17.5	16	0.007
	R1/4	3108 06 13	14	10.5	18	16	0.016
8	R1/8	3108 08 10	10	13.5	22	23	0.009
	R1/4	3108 08 13	14	13.5	21	23	0.016
10	R3/8	3108 08 17	17	13.5	21	23	0.020
	R1/4	3108 10 13	15	16	24	26.5	0.017
	R3/8	3108 10 17	17	16	24	26.5	0.022
12	R1/2	3108 10 21	21	16	24	26.5	0.035
	R1/4	3108 12 13	15	19	27	31	0.021
14	R3/8	3108 12 17	17	19	27	31	0.026
	R1/2	3108 12 21	21	19	27	31	0.039
16	R3/8	3108 14 17	20	22	30.5	35	0.037
	R1/2	3108 14 21	24	22	28.5	35	0.048
16	R3/8	3108 16 17	27	27	53	38.5	0.128
	R1/2	3108 16 21	27	27	53	38.5	0.124

Pre-coated thread. The body swivels for positioning purposes.

3198 Stud Branch Tee, Male BSPP and Metric Thread

Technical polymer, nickel-plated brass, NBR

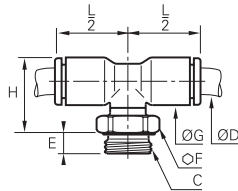

ØD	C		E	F	G	H	L/2	Kg
4	M5x0.8	3198 04 19	3.5	8	8.5	17.5	14	0.003
	G1/8	3198 04 10	5	13	8.5	15	14	0.006
	G1/4	3198 04 13	5.5	16	8.5	15	14	0.011
6	M5x0.8	3198 06 19	3.5	8	10.5	19.5	16	0.004
	G1/8	3198 06 10	5	13	10.5	17	16	0.007
8	G1/4	3198 06 13	5.5	16	10.5	17	16	0.012
	G1/8	3198 08 10	4.5	13	13.5	23.5	23	0.011
	G1/4	3198 08 13	5.5	16	13.5	21.5	23	0.014
10	G3/8	3198 08 17	5.5	20	13.5	21.5	23	0.019
	G1/4	3198 10 13	5.5	16	16	26	26.5	0.017
	G3/8	3198 10 17	5.5	20	16	24	26.5	0.020
12	G1/2	3198 10 21	7.5	24	16	24	26.5	0.029
	G1/4	3198 12 13	5.5	16	19	29	31	0.021
14	G3/8	3198 12 17	5.5	20	19	27	31	0.024
	G1/2	3198 12 21	7	24	19	27	31	0.033
16	G3/8	3198 14 17	5.5	20	22	32.5	35.5	0.036
	G1/2	3198 14 21	7	24	22	27	35.5	0.035
16	G3/8	3198 16 17	7.5	27	27	54.5	38.5	0.121
	G1/2	3198 16 21	9	27	27	54.5	38.5	0.117

The body swivels for positioning purposes.

3103 Stud Run Tee, BSPT Thread

Technical polymer, nickel-plated brass, NBR

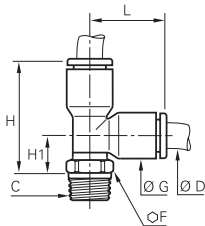

ØD	C		F	G	H	H1	L	Kg
4	R1/8	3103 04 10	10	8.5	23.5	9	14.5	0.006
	R1/4	3103 04 13	14	8.5	24	9.5	14.5	0.015
6	R1/8	3103 06 10	10	10.5	27.5	10	17.5	0.007
	R1/4	3103 06 13	14	10.5	28	10.5	17.5	0.016
8	R1/8	3103 08 10	10	13.5	35	12	23	0.009
	R1/4	3103 08 13	14	13.5	34	11	23	0.016
10	R3/8	3103 08 17	17	13.5	34	11	23	0.020
	R1/4	3103 10 13	15	16	40.5	14	26.5	0.017
	R3/8	3103 10 17	17	16	40.5	14	26.5	0.022
12	R1/2	3103 10 21	21	16	40.5	14	26.5	0.035
	R1/4	3103 12 13	15	19	46.5	15.5	31	0.021
14	R3/8	3103 12 17	17	19	46.5	15.5	31	0.026
	R1/2	3103 12 21	21	19	46.5	15.5	31	0.039
16	R3/8	3103 14 17	20	22	55	19.5	35.5	0.038
	R1/2	3103 14 21	24	22	52.5	17.5	35.5	0.048
16	R3/8	3103 16 17	27	27	78	27	38.5	0.126
	R1/2	3103 16 21	27	27	78	27	38.5	0.124

Pre-coated thread
The body swivels for positioning purposes.

Stud Fittings

3193 Stud Run Tee, Male BSPP and Metric Thread

Technical polymer, nickel-plated brass, NBR

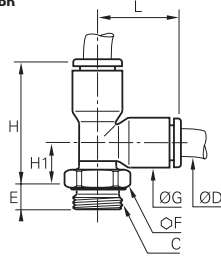

ØD	C		E	F	G	H	H1	L	Kg
4	M5x0.8	3193 04 19	3.5	8	8.5	26	11.5	14.5	0.003
	G1/8	3193 04 10	5	13	8.5	23	8.5	14.5	0.006
	G1/4	3193 04 13	5.5	16	8.5	23	8.5	14.5	0.011
6	M5x0.8	3193 06 19	3.5	8	10.5	29.5	12.5	17.5	0.004
	G1/8	3193 06 10	5	13	10.5	27	10	17.5	0.007
	G1/4	3193 06 13	5.5	16	10.5	27	10	17.5	0.012
8	G1/8	3193 08 10	4.5	13	13.5	36.5	14	23	0.011
	G1/4	3193 08 13	5.5	16	13.5	34.5	12	23	0.014
	G3/8	3193 08 17	5.5	20	13.5	34.5	12	23	0.019
10	G1/4	3193 10 13	5.5	16	16	42	15.5	26.5	0.017
	G3/8	3193 10 17	5.5	20	16	40.5	14	26.5	0.020
	G1/2	3193 10 21	7.5	24	16	40.5	14	26.5	0.029
12	G1/4	3193 12 13	5.5	16	19	48	17	31	0.021
	G3/8	3193 12 17	5.5	20	19	46.5	15.5	31	0.024
	G1/2	3193 12 21	7	24	19	46.5	15.5	31	0.033
14	G3/8	3193 14 17	5.5	20	22	56.5	21.5	35.5	0.036
	G1/2	3193 14 21	7	24	22	51	16	35.5	0.035
	G3/8	3193 16 17	7.5	27	27	79.5	41	38.5	0.121
16	G1/2	3193 16 21	9	27	27	79.5	41	38.5	0.117

The body swivels for positioning purposes.

3148 Y Piece, Male BSPT Thread

Technical polymer, nickel-plated brass, NBR

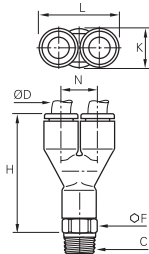

ØD	C		F	H	K	L	N	Kg
4	R1/8	3148 04 10	10	32.5	8.5	17.5	9	0.009
	R1/4	3148 04 13	14	33	8.5	17.5	9	0.019
6	R1/8	3148 06 10	10	39.5	10.5	21.5	11	0.011
	R1/4	3148 06 13	14	40	10.5	21.5	11	0.021
8	R1/8	3148 08 10	13	56.5	13.5	28	14.5	0.020
	R1/4	3148 08 13	14	55.5	13.5	28	14.5	0.025
10	R1/4	3148 10 13	14	60	19	39	20	0.033
	R3/8	3148 10 17	16	60.5	19	39	20	0.042
	R1/2	3148 10 21	24	61	19	39	20	0.062
12	R3/8	3148 12 17	19	66	19	39	20	0.053
	R1/2	3148 12 21	21	66	19	39	20	0.059

Pre-coated thread

The body swivels for positioning purposes.

3158 Y Piece, Male BSPP and Metric Thread

Technical polymer, nickel-plated brass, NBR

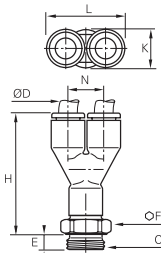

ØD	C		E	F	H	K	L	N	Kg
4	M5x0.8	3158 04 19	3.5	8	32.5	8.5	17.5	9	0.006
	G1/8	3158 04 10	5	13	32	8.5	17.5	9	0.009
	G1/4	3158 04 13	5.5	16	32.5	8.5	17.5	9	0.014
6	M5x0.8	3158 06 19	3.5	10	39.5	10.5	21.5	11	0.009
	G1/8	3158 06 10	5	13	39	10.5	21.5	11	0.012
	G1/4	3158 06 13	5.5	16	39.5	10.5	21.5	11	0.017
8	G1/8	3158 08 10	5	13	49	13.5	28	14.5	0.020
	G1/4	3158 08 13	5.5	16	49.5	13.5	28	14.5	0.023
	G3/8	3158 08 17	6	19	48	13.5	28	14.5	0.030
10	G1/4	3158 10 13	5.5	16	58	16	33	17	0.031
	G3/8	3158 10 17	6	20	57.5	16	33	17	0.040
	G1/2	3158 10 21	7	24	58	16	33	17	0.054
12	G3/8	3158 12 17	6	20	62	19	39	20	0.044
	G1/2	3158 12 21	7	24	63	19	39	20	0.050

The body swivels for positioning purposes.

Stud Fittings

3112 Double Y Piece, Male BSPT Thread

Technical polymer, nickel-plated brass, NBR

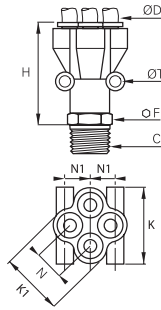

ØD	C		F	H	K	K1	N	N1	ØT	Kg
4	R1/8	3112 04 10	13	41.5	25.5	21	10	8.5	3.7	0.022
	R1/4	3112 04 13	14	43.5	25.5	21	10	8.5	3.7	0.027
6	R1/8	3112 06 10	19	54.5	31.5	26.5	12	10	3.7	0.041
	R1/4	3112 06 13	19	57.5	31.5	26.5	12	10	3.7	0.047

Pre-coated thread

The body swivels for positioning purposes.

3132 Double Y, Male BSPP Thread

Technical polymer, nickel-plated brass, NBR

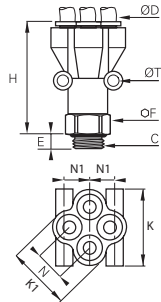

ØD	C		E	F	H	K	K1	N	N1	ØT	Kg
4	G1/8	3132 04 10	5	13	41	25.5	21	10	8.5	3.7	0.022
	G1/4	3132 04 13	5.5	16	40	25.5	21	10	8.5	3.7	0.026
6	G1/8	3132 06 10	5	19	53.5	31.5	26.5	12	10	3.7	0.040
	G1/4	3132 06 13	5.5	19	52.5	31.5	26.5	12	10	3.7	0.042

The body swivels for positioning purposes.

3100 Carstick® Cartridge

Brass, NBR

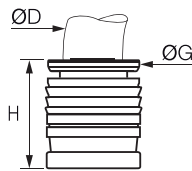

ØD		G	G1	H	L	Kg
4	3100 04 00	8	11	10	554	0.001
6	3100 06 00	10	14.5	11.5	629	0.002
8	3100 08 00	13	15	15	794	0.002
10	3100 10 00	15.5	19.5	17	930	0.005
12	3100 12 00	19.5	21	19.5	1038	0.010
14	3100 14 00	21	24.5	22.5	1100	0.013

50 cartridges per Carstick®.

Cavity dimensions are available in chapter 2. For the 14 mm cartridge, please consult us regarding cavity dimensions.



3100 Carstick® Cartridge

Nickel-plated brass, NBR

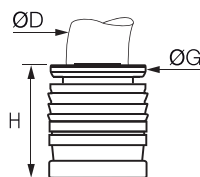

ØD		G	G1	H	L	Kg
1/8	3100 53 00 99	7	10	9	508	0.002
1/4	3100 56 00 99	10.5	14.5	12	600	0.003
3/8	3100 60 00 99	15.5	19	16.5	930	0.006

50 cartridges per Carstick®.

5/32" (4 mm) and 5/16" (8 mm) also available.

Cavity dimensions are available in chapter 2.

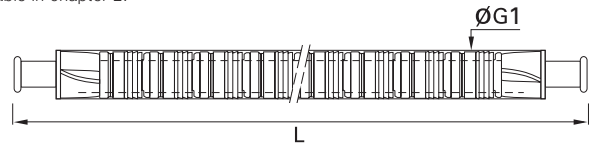

Other products are available upon request; please do not hesitate to consult us.

Tube-to-Tube Fittings

3106 Equal and Unequal Tube-to-Tube Connector

Technical polymer, NBR

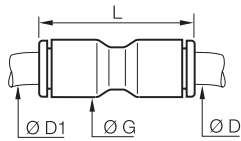

ØD	ØD1		G	L	Kg
3	3	3106 03 00	8.5	25	0.002
	4	3106 03 04	8.5	25	0.002
4	1/4	3106 04 56	11	29.5	0.005
	4	3106 04 00	8.5	25	0.001
	6	3106 04 06	11	28	0.002
	8	3106 04 08	13.5	38	0.005
6	1/4	3106 06 56	13.5	36	0.009
	6	3106 06 00	10.5	28.5	0.002
	8	3106 06 08	13.5	38	0.005
	10	3106 06 10	16	42	0.007
8	8	3106 08 00	13.5	38	0.004
	10	3106 08 10	16	42	0.008
	12	3106 08 12	19	50.5	0.026
10	10	3106 10 00	16	42	0.005
	12	3106 10 12	19	50.5	0.019
12	1/2	3106 12 62	22	56.5	0.024
	12	3106 12 00	19	50.5	0.009
	14	3106 12 14	22	56	0.026
	16	3106 12 16	27	61	0.066
14	14	3106 14 00	22	56	0.014
16	16	3106 16 00	27	60.5	0.041

3106 Equal and Unequal Tube-to-Tube Connector

Inch

Technical polymer, NBR

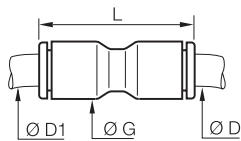

ØD	ØD1		G	L	Kg
1/4	1/4	3106 56 00	10.9	29.5	0.002
	3/8	3106 60 00	16	42	0.006
3/8	10	3106 60 10	12	50.5	0.029
	1/4	3106 60 56	16	41	0.016
1/2	1/2	3106 62 00	22	55	0.016

5/32"(4 mm) and 5/16"(8 mm) also available

3102 Equal and Unequal Elbow

Technical polymer, NBR

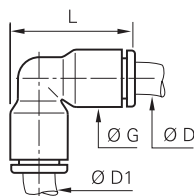

ØD	ØD1		G	L	Kg
4	4	3102 04 00	8.5	19	0.001
	6	3102 04 06	10.5	22.5	0.004
6	6	3102 06 00	10.5	22.5	0.002
	8	3102 06 08	13.5	29.5	0.008
8	8	3102 08 00	13.5	29.5	0.004
	10	3102 08 10	16	34.5	0.012
10	10	3102 10 00	16	34.5	0.006
	12	3102 10 12	19	40.5	0.020
12	12	3102 12 00	19	40.5	0.010
14	14	3102 14 00	22	46.5	0.015
16	16	3102 16 00	27	52	0.043

3102 Equal and Unequal Elbow

Inch

Technical polymer, NBR

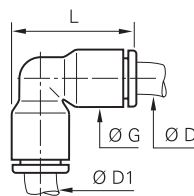

ØD	ØD1		G	L	Kg
1/4	1/4	3102 56 00	11	23.5	0.002
3/8	3/8	3102 60 00	16	34	0.006
1/2	1/2	3102 62 00	22	35	0.017

5/32"(4 mm) and 5/16"(8 mm) also available

Tube-to-Tube Fittings

3104 Equal and Unequal Tee

Technical polymer, NBR

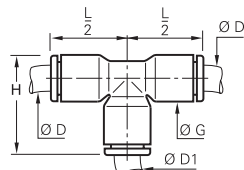

ØD	ØD1		G	H	L/2	Kg
3	3	3104 03 00	8.5	19	14.5	0.004
4	4	3104 04 00	8.5	19	14.5	0.002
	6	3104 04 06	10.5	22.5	17.5	0.007
6	4	3104 06 04	10.5	22.5	17.5	0.005
	6	3104 06 00	10.5	22.5	17.5	0.003
8	8	3104 06 08	13.5	29.5	23	0.015
	4	3104 08 04	13.5	29	17.5	0.013
8	6	3104 08 06	13.5	29.5	23	0.010
	8	3104 08 00	13.5	29.5	23	0.006
10	10	3104 08 10	16	34.5	26.5	0.020
	4	3104 10 04	16	33	26	0.023
10	8	3104 10 08	16	34.5	26.5	0.014
	10	3104 10 00	16	34.5	26.5	0.009
12	12	3104 10 12	19	40.5	31	0.034
	4	3104 12 04	19	39	31	0.040
12	10	3104 12 10	19	40.5	31	0.024
	12	3104 12 00	19	40.5	31	0.014
14	8	3104 14 08	22	46	35.5	0.053
	14	3104 14 00	22	46	35.5	0.023
16	12	3104 16 12	27	52.5	39	0.088
	16	3104 16 00	27	52	39	0.063

3104 Equal and Unequal Tee

Inch

Technical polymer, NBR

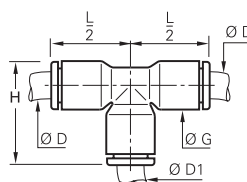

ØD	ØD1		G	H	L/2	Kg
5/32	1/4	3104 04 56	11	23.5	18	0.008
1/8	1/8	3104 53 00	8.4	19	14.5	0.003
	1/4	3104 53 56	11	23.5	18	0.011
3/16	3/16	3104 55 00	10.9	27.2	21.6	0.016
	5/32	3104 56 04	11	23.5	18.5	0.014
1/4	1/4	3104 56 00	11	23	24	0.003
	1/8	3104 56 53	11	23.5	18.5	0.007
3/8	3/8	3104 56 60	16	33.5	24.5	0.017
	1/4	3104 60 56	16	32.5	25.5	0.019
3/8	1/2	3104 60 62	22	46	35	0.069
	3/8	3104 60 00	16	34	26	0.009
1/2	1/2	3104 62 00	22	46	35	0.026
	1/4	3104 62 56	22.1	45.2	35.3	0.021
	3/8	3104 62 60	22	46	35	0.060

5/32"(4 mm) and 5/16"(8 mm) also available

3140 Equal and Unequal Single Y Piece

Technical polymer, NBR

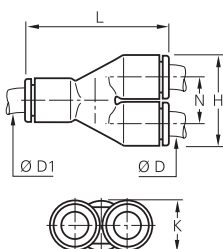



ØD	ØD1		H	K	L	N	Kg
4	4	3140 04 00	17.5	8.5	28.5	9	0.002
	6	3140 04 06	17.5	10.5	33	9	0.003
6	6	3140 06 00	21.5	10.5	35	11	0.003
	8	3140 06 08	22.5	13.5	41	11.5	0.005
8	8	3140 08 00	28	13.5	45	14.5	0.006
	10	3140 08 10	28	16	47	14.5	0.007
10	10	3140 10 00	33	16	53	17	0.010
	12	3140 10 12	33	19	57	17	0.012
12	12	3140 12 00	39	19	57	17	0.017

Tube-to-Tube Fittings

3107 Equal and Unequal Cross

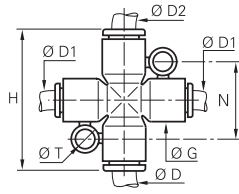
Technical polymer, NBR



ØD	ØD1	ØD2		G	H	N	ØT	Kg
4	4	4	 3107 04 00	11	36	20	4.2	0.014
6	4	6	3107 04 06	11	36	20	4.2	0.009
4	4	6	3107 06 04	11	36	20	4.2	0.012
6	6	6	3107 06 00	11	36	20	4.2	0.005
8	6	8	3107 06 08	11	46	22.5	4.2	0.018
6	6	8	3107 08 06	13.5	46	22.5	4.2	0.022
8	8	8	3107 08 00	13.5	46	22.5	4.2	0.009

Boxes protect the contents and are designed to meet your requirements:

- part numbers and corresponding product pictures allow for immediate visual identification
- bar codes
- easy storage
- tamper-proof system of opening/closing
- recyclable material



Bulkhead Connector Fittings

3116 Equal Bulkhead Connector

Technical polymer, NBR

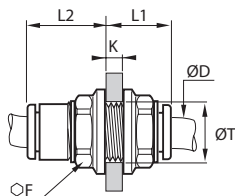

ØD		F	K _{max}	L1	L2	ØT _{min}	Kg
4	3116 04 00	13	5.5	15	10	10.5	0.003
6	3116 06 00	15	8.5	18	10.5	12.5	0.004
8	3116 08 00	18	14.5	25	13.5	15.5	0.007
10	3116 10 00	22	14.5	27.5	15.5	18.5	0.011
12	3116 12 00	26	18.5	33	18	22.5	0.019
14	3116 14 00	29	20.5	37.5	20.5	25.5	0.028

3146 Equal Mixed Bulkhead Connector

Nickel-plated brass, NBR

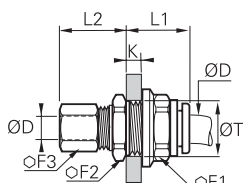

ØD		F1	F2	F3	K _{max}	L1	L2	ØT _{min}	Kg
4	3146 04 00	13	13	10	7	17.5	17.5	10.5	0.018
6	3146 06 00	15	17	13	8	19	18	12.5	0.029
8	3146 08 00	18	19	14	8	20.5	20.5	15.5	0.036
10	3146 10 00	22	22	19	8.5	23	24.5	18.5	0.066
12	3146 12 00	26	25	22	8.5	27	25	22.5	0.096
14	3146 14 00	29	29	24	10.5	27	27	25.5	0.124

Push-in connection with compression fitting

3136 Bulkhead Connector, Female BSPP Thread

Nickel-plated brass, NBR

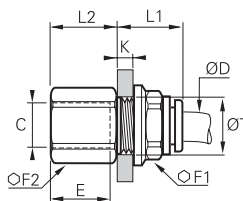

ØD	C		E	F1	F2	K _{max}	L1	L2	ØT _{min}	Kg
4	G1/8	3136 04 10	9.5	13	13	7	17	11.5	10.5	0.015
	G1/4	3136 04 13	13.5	13	16	7	17	15.5	10.5	0.021
6	G1/8	3136 06 10	9.5	15	15	8	19	10.5	12.5	0.020
	G1/4	3136 06 13	13.5	15	17	7	19	15.5	12.5	0.027
8	G3/8	3136 06 17	12	15	22	8	19	16	12.5	0.041
	G1/8	3136 08 10	9.5	18	17	8	20.5	10.5	15.5	0.029
10	G1/4	3136 08 13	13.5	18	17	8	20.5	14.5	15.5	0.029
	G3/8	3136 10 17	14	22	22	8.5	23	16	18.5	0.051
12	G3/8	3136 12 17	14	26	24	8.5	27	16	22.5	0.079
	G1/2	3136 12 21	19.5	26	27	8.5	27	21.5	22.5	0.098
16	G3/8	3136 16 17	12	29	29	10.5	30	15	27.5	0.125
	G1/2	3136 16 21	15	29	29	10.5	30	19.5	27.5	0.126

3139 Equal Bulkhead Elbow

Technical polymer, nickel-plated brass, NBR

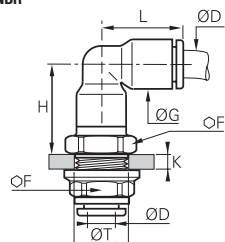

ØD		F	G	H	K _{max}	L	ØT _{min}	Kg
4	3139 04 00	13	8.5	17	6.5	14.5	10.5	0.014
6	3139 06 00	15	10.5	19.5	7	17.5	12.5	0.021
8	3139 08 00	18	13.5	24	8	23	15.5	0.032
10	3139 10 00	22	16	28	8.5	26	18.5	0.049
12	3139 12 00	26	19	33	8.5	31	22.5	0.086
14	3139 14 00	29	25.5	37.5	10.5	36	25.5	0.117

The body swivels for positioning purposes.

Multiple Fittings

3144 Equal and Unequal Multiple Y Piece

Technical polymer, NBR

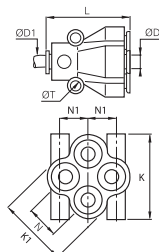

ØD	ØD1		K	K1	L	N	N1	ØT	Kg
4	4	3144 04 04	25.5	21	30.5	10	8.5	3.7	0.016
	6	3144 04 06	26	21	30.5	10	10	3.7	0.013
6	6	3144 06 06	31.5	26.5	37.5	12	8.5	3.7	0.031
	8	3144 06 08	31.5	26.5	38	12	10	3.7	0.026

3304 Multiple Tee

Technical polymer, NBR

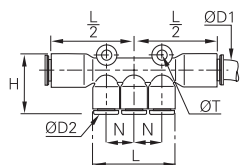

ØD1	ØD2		H	L	L/2	N	ØT	Kg
6	4	3304 06 04	24.5	34	37	11.5	4.2	0.015
8	4	3304 08 04	24.5	34	37	11.5	4.2	0.012
	6	3304 08 06	24.5	34	37	11.5	4.2	0.010
10	6	3304 10 06	36	44	40.5	14.5	4.2	0.019
	8	3304 10 08	36	44	40.5	15.5	4.2	0.015

3306 90° Multiple Elbow

Technical polymer, NBR

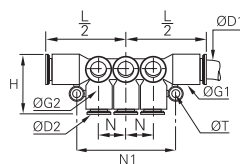

ØD1	ØD2		G	G1	H	L/2	N	N1	ØT	Kg
6	4	3306 06 04	13.5	11	18.5	36	43	11.5	4.2	0.034
8	4	3306 08 04	13.5	11	18.5	36.5	43	11.5	4.2	0.025
	6	3306 08 06	13.5	11	18.5	36.5	43	11.5	4.2	0.022
10	6	3306 10 06	16	13.5	23	42	52	14.5	4.2	0.048
	8	3306 10 08	16	13.5	23.5	42	52	14.5	4.2	0.021

3310 In-Line Manifold

Treated aluminium, NBR

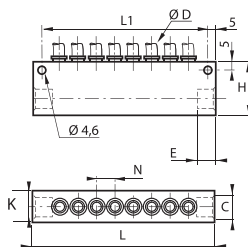

ØD	C		Number of Outlets	E	H	K	L	L1	N	Kg
4	G1/4	3310 04 13	8	10	33	20	114	104	11.5	0.164
6	G1/4	3310 06 13	8	10	33	20	114	104	12.5	0.170
8	G3/8	3310 08 17	6	12	33	20	114	104	15	0.148
10	G1/2	3310 10 21	6	16	48	25	145.5	135.5	17	0.334
12	G1/2	3310 12 21	6	16	45	25	158	148	20.5	0.370

Plug-In Fittings and Accessories

3182 Equal and Unequal Plug-In Elbow

Technical polymer, NBR

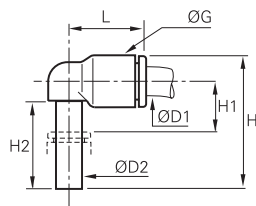

ØD1	ØD2		G	H	H1	H2	L	Kg
4	4	3182 04 00	8.5	23	6	15.5	14	0.001
	6	3182 04 06	10.5	26.5	7	17	16	0.003
6	4	3182 06 04	10.5	24.5	7	15.5	16	0.001
	6	3182 06 00	10.5	26.5	7	17	16	0.001
8	8	3182 06 08	13.5	33.5	8	21.5	23	0.007
	8	3182 08 00	13.5	33.5	8	21.5	23	0.003
10	10	3182 08 10	16	39	10	24.5	26.5	0.010
	10	3182 10 00	16	39	10	24.5	26.5	0.004
12	12	3182 10 12	19	44.5	10.5	27.5	31	0.017
	12	3182 12 00	19	45.5	10.5	27.5	31	0.007

3182 Equal Plug-In Elbow

Inch

Technical polymer, NBR

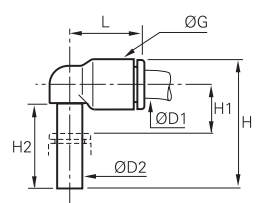

ØD1	ØD2		G	H	H1	H2	L	Kg
1/4	1/4	3182 56 00	11	27.5	7.5	18	18.5	0.002
3/8	3/8	3182 60 00	16	38.5	9	24	26	0.010
1/2	1/2	3182 62 00	22	51	13	28	35	0.030

5/32"(4 mm) and 5/16"(8 mm) also available

3184 Extended Equal and Unequal Plug-In Elbow

Technical polymer, NBR

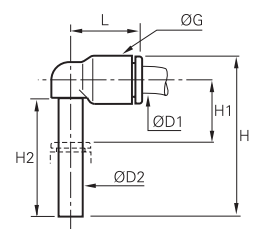

ØD1	ØD2		G	H	H1	H2	L	Kg
4	4	3184 04 00	8.5	32.5	15.5	25	14	0.004
	6	3184 04 06	10.5	38.5	19	29	16	0.004
6	6	3184 06 00	10.5	38.5	19	29	16	0.002
	8	3184 06 08	13.5	49	23.5	37	23	0.007
8	8	3184 08 00	13.5	49	23.5	37	23	0.003
	10	3184 08 10	16	56	26.5	41.5	26.5	0.011
10	10	3184 10 00	16	56	26.5	41.5	26.5	0.005
	12	3184 10 12	19	62.5	28	45.5	31	0.017
12	12	3184 12 00	19	62.5	28	45.5	31	0.008

3180 45° Plug-In Equal Elbow

Technical polymer, NBR

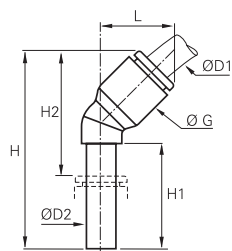

ØD1	ØD2		G	H	H1	H2	L	Kg
4	4	3180 04 00	9	33.5	19	21	13	0.001
6	6	3180 06 00	11	39	21	25	14.5	0.002
8	8	3180 08 00	13.5	44	21.5	25.5	19.5	0.003
10	10	3180 10 00	16	53	27	32.5	23	0.004
12	12	3180 12 00	19	58.5	27.5	34	26.5	0.007

Plug-In Fittings and Accessories

3183 Equal and Unequal Plug-In Run Tee

Technical polymer, NBR

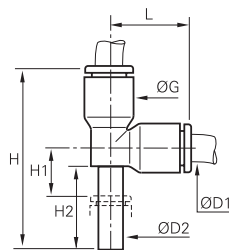

ØD1	ØD2		G	H	H1	H2	L	Kg
4	4	3183 04 00	8.5	33	6	15.5	14.5	0.002
	6	3183 04 06	10.5	38.5	7	17	17.5	0.007
6	6	3183 06 00	10.5	38.5	7	17	17	0.002
	8	3183 06 08	13.5	48.5	8	21.5	23	0.013
8	8	3183 08 00	13.5	49	8	21.5	23	0.005
	10	3183 08 10	16	56.5	10.5	24.5	26.5	0.018
10	10	3183 10 00	16	57	10.5	24.5	26.5	0.007
	12	3183 10 12	19	65.5	10.5	27.5	31	0.034
12	12	3183 12 00	19	65.5	10.5	27.5	31	0.011

3188 Equal and Unequal Plug-In Branch Tee

Technical polymer, NBR

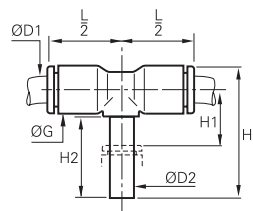

ØD1	ØD2		G	H	H1	H2	L/2	Kg
4	4	3188 04 00	8.5	25	8	15.5	14.5	0.002
	6	3188 04 06	10.5	28.5	9	17	16	0.007
6	6	3188 06 00	10.5	28.5	9	17	16	0.002
	8	3188 06 08	13.5	36.5	11	21.5	22	0.014
8	8	3188 08 00	13.5	36.5	11	21.5	23	0.004
	10	3188 08 10	16	41	12.5	24.5	26.5	0.018
10	10	3188 10 00	16	41	12.5	24.5	26.5	0.007
	12	3188 10 12	19	46.5	12.5	27.5	31	0.031
12	12	3188 12 00	19	46.5	12.5	27.5	31	0.012

3142 Equal and Unequal Plug-In Single Y Piece

Technical polymer, NBR

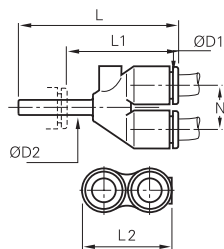

ØD1	ØD2		L	L1	L2	N	Kg
4	4	3142 04 00	34	21.5	17.5	9	0.002
	6	3142 04 06	35.5	21.5	17.5	9	0.002
6	6	3142 06 00	39.5	25.5	21.5	11	0.004
	8	3142 06 08	44	25.5	21.5	11	0.015
8	8	3142 08 00	50.5	32	28	14.5	0.007
	10	3142 08 10	53.5	32	28	14.5	0.024
10	10	3142 10 00	57.5	36	33	17	0.010
	12	3142 10 12	60	35	33	17	0.037
12	12	3142 12 00	66	41	39	20	0.017

3143 Multiple Plug-In Y Piece

Technical polymer, nickel-plated brass, NBR

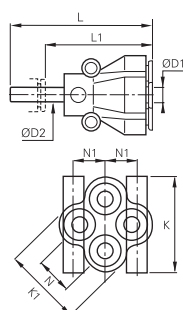

ØD1	ØD2		K	K1	L	L1	N	N1	Kg
4	6	3143 04 06	26	21.5	49.5	35.5	11	8.5	0.018
	8	3143 04 08	26	21.5	51	32	11	8.5	0.021
6	8	3143 06 08	31.5	26.5	57.5	39	12	10	0.035

Plug-In Fittings and Accessories

3120 Stem Connector

Technical polymer

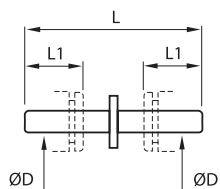

ØD		L	L1	Kg
4	3120 04 00	34.5	12	0.001
6	3120 06 00	38.5	14	0.001
8	3120 08 00	41	18.5	0.001
10	3120 10 00	51.5	20.5	0.002
12	3120 12 00	60	24.5	0.004
14	3120 14 00	69.5	25.5	0.007

This model exists in nickel-plated brass; please use suffix 85. Example: 3120 04 00 85
Only compatible with Parker Legris fittings. Drawing available upon request.

3166 Plug-In Reducer

Technical polymer, NBR

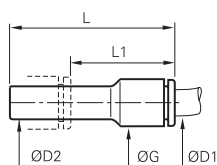

ØD1	ØD2		G	L	L1	Kg
3	4	3166 03 04	8.5	37.5	23.5	0.002
4	6	3166 04 06	8.5	37.5	23.5	0.001
4	8	3166 04 08	8.5	37.5	19	0.001
	10	3166 04 10	12	44	22.5	0.003
6	8	3166 06 08	10.5	37.5	20	0.001
	10	3166 06 10	10.5	38	17.5	0.002
	12	3166 06 12	14.5	46	23	0.005
8	14	3166 08 14	14.5	48	23	0.006
	10	3166 08 10	13.5	49	28.5	0.003
	12	3166 08 12	13.5	49	24.5	0.004
8	14	3166 08 14	17	48	23	0.007
	12	3166 10 12	21.5	56.5	33.5	0.005
10	14	3166 10 14	21.5	58.5	33.5	0.005
	12	3166 12 14	23.5	58.5	33.5	0.007

3166 Plug-In Reducer

Inch

Technical polymer, NBR

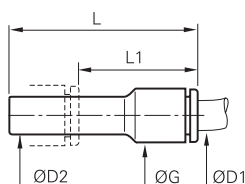

ØD1	ØD2		G	L	L1	Kg
1/4	5/16	3166 56 08	11	41	23	0.002
	3/8	3166 56 60	11	41	21	0.002

3168 Plug-In Increaser

Technical polymer, NBR

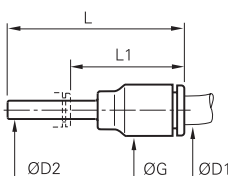

ØD1	ØD2		G	L	L1	Kg
6	4	3168 06 04	10.5	35	23	0.001
8	6	3168 08 06	13.5	45	31.5	0.003
	1/4	3168 08 56	16	40	25.5	0.009
10	8	3168 10 08	16	42.5	21	0.004
12	10	3168 12 10	19	49	24.5	0.012

3168 Plug-In Increaser

Inch

Technical polymer, NBR

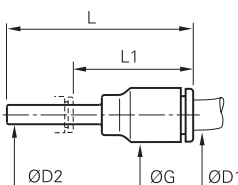

ØD1	ØD2		G	L	L1	Kg
1/4	3/16	3168 56 55	20.5	41	25	0.002
	5/32	3168 56 04	11	41	29	0.001

Plug-In Fittings and Accessories

3126 Blanking Plug

Technical polymer

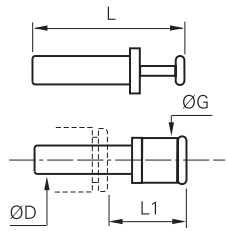

ØD		G	L	L1	Kg
3	3126 03 00	6	25	13.5	0.001
4	3126 04 00	4	30	15.5	0.001
6	3126 06 00	8	33	16.5	0.001
8	3126 08 00	10	35	17.5	0.001
10	3126 10 00	12	42	21	0.002
12	3126 12 00	14	45	22	0.003
14	3126 14 00	16	49	23.5	0.005
16	3126 16 00*	19	57	30	0.064

*Nickel-plated brass

3126 Blanking Plug

Inch

Technical polymer

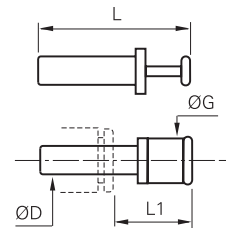

ØD		G	L	L1	Kg
1/4	3126 56 00	8	36.5	22	0.001
3/8	3126 60 00	12	42	22	0.002
1/2	3126 62 00	15	48.5	21.5	0.003

5/32"(4 mm) and 5/16"(8 mm) also available

3122 Plug-In Barb Connector

Technical polymer

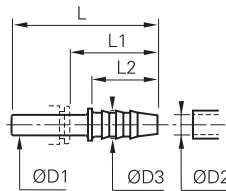

ØD1	ØD2		ØD3	L	L1	L2	Kg
4	3.2	3122 04 53	5	37	25	17	0.004
	5	3122 04 05	7	37	25	17	0.005
6	5	3122 06 05	7	39	25	17	0.001
8	6.3	3122 08 56	8.5	39.5	21	17	0.001
	8	3122 08 08	10	44.5	26	22	0.001
10	6.3	3122 10 56	8	45	24.5	17	0.002
	8	3122 10 08	10	50	29.5	22	0.002
	8	3122 12 08	10	50	26	22	0.002
12	10	3122 12 10	12	48.5	25.5	22.5	0.002
	12.5	3122 12 62	14.5	57	34	22.5	0.004
14	12.5	3122 14 62	14.5	59.5	34.5	22.5	0.022

3151 End Cap

Technical polymer, NBR

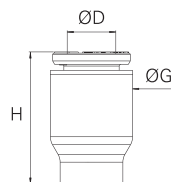

ØD		G	H	Kg
4	3151 04 00	8.5	15	0.001
6	3151 06 00	10.5	17	0.001
8	3151 08 00	13.5	22	0.003
10	3151 10 00	16	22	0.003
12	3151 12 00	19	28	0.005
14	3151 14 00	22	31	0.009

Other products are available upon request; please do not hesitate to consult us.

Banjo Fittings

This range of fittings is ideal when access is only possible from above and **orientation of the tube** is required. This range of modular fittings includes single and multiple configurations, allowing **wide flexibility of design**.

Product Advantages

Compact Compact design with minimum space between fittings
 Banjo bolt designed for maximum flow
 Easy access, even when fittings are close together
 Easy assembly and automatic sealing:
 • with pre-coating on taper threads
 • with an integral O-ring seal on parallel threads
 Safe operation: orientation of tube is ensured
 100% leak-tested in production
 Date coding to guarantee quality and traceability

Modular Effortless stacking of banjo bodies to allow construction of 2 to 6 outlets
 Orientable (360°) for perfect alignment
 Modular: tube diameters may be different



Applications

Robotics
 Automotive Process
 Pneumatics
 Semi-Conductors
 Textile
 Packaging

Technical Characteristics

Compatible Fluids	Compressed air Other fluids: please consult us
Working Pressure	Vacuum to 20 bar
Working Temperature	-20°C to +80°C

Tightening Torque (daN.m)	Threads					
	M3 x0.5	M5 x0.8	G1/8	G1/4	G3/8	G1/2
	0.05	0.1	0.4	0.5	0.6	0.7

Reliable performance is dependent upon the type of fluid conveyed, component materials and tubing being used.
 Use is guaranteed with a vacuum of 755 mm Hg (99% vacuum).

Component Materials

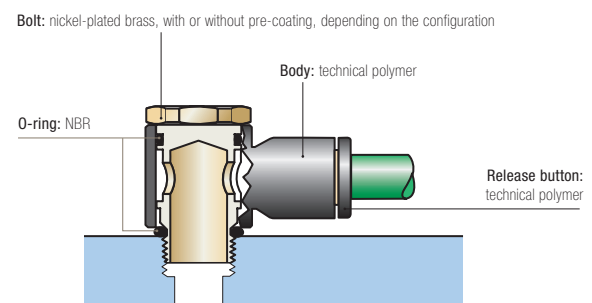

Silicone-free

Regulations

ISO 14743: Pneumatic fluid power, push-in connectors for thermoplastic tubes
 DI : 2002/95/EC (RoHS)
 2011/65/EC
 DI : 97/23/EC (PED)
 DI : 1907/2006 (REACH)

Installation Configurations

Thread and bore diameters for part numbers 3524 - 3527 - 3528 - 3529:

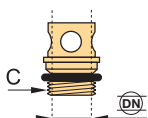

Thread (C)	M5x0.8	G1/8	G1/4	G3/8	G1/2
DN	2.5	5.5	8.5	11	13

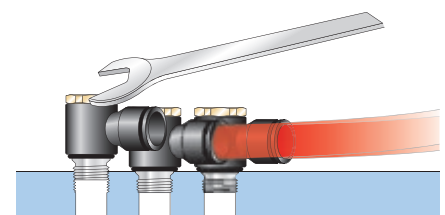

Banjo Fittings

3118 Single Banjo, Male BSPP and Metric Thread

Technical polymer, nickel-plated brass, NBR

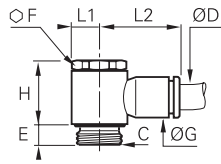

ØD	C		E	F	G	H	L1	L2	Kg
3	M3x0.5	3118 03 09*	3	-	8.5	13	5	16	0.005
	M5x0.8	3118 03 19*	4	-	8.5	13	5	16	0.005
4	M5x0.8	3118 04 19*	4	-	8.5	13	5	16.5	0.004
	G1/8	3118 04 10	4	13	8.5	17	7	18.5	0.012
6	M5x0.8	3118 06 19*	4	-	10.5	13	7	18.5	0.004
	G1/8	3118 06 10	4	13	10.5	17	7	20	0.013
6	G1/4	3118 06 13	5.5	17	10.5	21	9.5	22	0.023
	G1/8	3118 08 10	4	13	13.5	16.5	7	25	0.014
8	G1/4	3118 08 13	5.5	17	13.5	21	9	27	0.024
	G3/8	3118 08 17	5.5	20	13.5	24.5	11	29	0.038
8	G1/4	3118 10 13	5.5	17	16	21	9.5	29	0.025
	G3/8	3118 10 17	5.5	20	16	24.5	11	31	0.039
10	G1/2	3118 10 21	8	25	19	27.5	13.5	36.5	0.084
	G3/8	3118 12 17	5.5	20	19	24.5	11	34.5	0.041
12	G1/2	3118 12 21	8	25	19	27.5	13.5	36.5	0.074

*With screwdriver slot

3018 Single Banjo, Male BSPT Thread

Technical polymer, nickel-plated brass, NBR

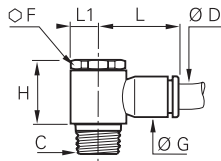

ØD	C		F	G	H	L	L1	Kg
4	R1/8	3018 04 10	13	8.5	18.5	18.5	7	0.015
	R1/8	3018 06 10	13	10.5	18.5	20	7	0.015
6	R1/4	3018 06 13	17	10.5	22.5	22	9.5	0.029
	R1/8	3018 08 10	13	13.5	18.5	25	7	0.016
8	R1/4	3018 08 13	17	13.5	22.5	27	9.5	0.030
	R3/8	3018 08 17	21	13.5	26.5	29	11	0.047
10	R1/4	3018 10 13	17	16	22.5	29	9.5	0.031
	R3/8	3018 10 17	21	16	26.5	31	11	0.048
12	R1/4	3018 12 13	21	19	26.5	34.5	11	0.051
	R3/8	3018 12 17	21	19	26.5	34.5	11	0.050
12	R1/2	3018 12 21	25	19	30	37	13.5	0.086

Pre-coated thread

3124 Single Banjo, Male/Female BSPP and Metric Thread

Technical polymer, nickel-plated brass, NBR

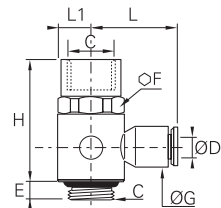

ØD	C		E	F	G	H	L	L1	Kg
4	M5x0.8	3124 04 19	4	8	8.5	19	16	5	0.006
	G1/8	3124 04 10	4	13	8.5	25.5	18.5	7	0.015
6	G1/4	3124 06 13	5.5	17	10.5	33	22	9	0.030
	G3/8	3124 08 17	5.5	20	13.5	37.5	29	11	0.043

This product family was developed to allow assembly of a function fitting on a cylinder.

3149 Twin Banjo, Male BSPP and Metric Thread

Technical polymer, nickel-plated brass, NBR

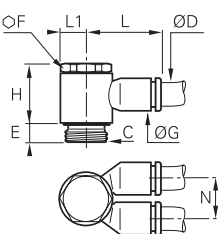

ØD	C		E	F	G	H	L	L1	N	Kg
4	M5x0.8	3149 04 19*	4	-	8.5	13	16	4.5	9	0.005
	G1/8	3149 04 10	4	13	10.5	16.5	18.5	7	11.5	0.018
6	G1/8	3149 06 10	4	13	10.5	16.5	18.5	7	11.5	0.014
	G1/4	3149 06 13	5.5	17	13.5	21	27	9.5	14.5	0.035
8	G1/4	3149 08 13	5.5	17	13.5	21	27	9.5	14.5	0.026
	G3/8	3149 08 17	5.5	20	16	24.5	31	11	17	0.053
10	G3/8	3149 10 17	5.5	20	16	24.5	31	11	17	0.042

*With screwdriver slot

3119 Double Banjo, BSPP and Metric Thread

Technical polymer, nickel-plated brass, NBR

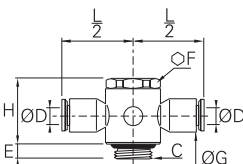

ØD	C		E	F	G	H	L/2	Kg
4	M5x0.8	3119 04 19*	4	-	8.5	13	8	0.005
	G1/8	3119 04 10	4	13	11	17	20	0.018
6	G1/8	3119 06 10	4	13	11	17	20	0.014
	G1/4	3119 06 13	5.5	17	13.5	21	26.5	0.035
8	G1/4	3119 08 13	5.5	17	13.5	21	27	0.026
	G3/8	3119 08 17	5.5	20	16	24.5	30.5	0.053
10	G3/8	3119 10 17	5.5	20	16	24.5	31	0.045

*With screwdriver slot

Banjo Fittings

3538 Single Banjo Bodies

Technical polymer, NBR

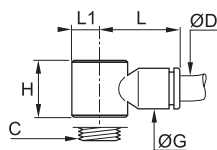

ØD	C		G	H	L	L1	Kg
3	M5x0.8	3538 03 19	8.5	13	16	5	0.003
4	M5x0.8	3538 04 19	8.5	13	16	5	0.001
	G1/8	3538 04 10	10.5	14.5	18.5	7	0.002
6	M5x0.8	3538 06 19	11	13	18.5	5	0.002
	G1/8	3538 06 10	10.5	14.5	20	7	0.002
	G1/4	3538 06 13	13.5	18	22	9.5	0.003
8	G1/8	3538 08 10	13.5	14.5	25	7	0.003
	G1/4	3538 08 13	13.5	18	27	9.5	0.004
	G3/8	3538 08 17	13.5	21.5	29	11.5	0.009
10	G1/4	3538 10 13	16	18	29	9.5	0.005
	G3/8	3538 10 17	16	21.5	31	11.5	0.006
12	G1/2	3538 10 21	19	22.5	36.5	13.5	0.019
	G3/8	3538 12 17	19	21.5	34.5	11.5	0.011
	G1/2	3538 12 21	19	22.5	36.5	13.5	0.009

3539 Double Banjo Bodies

Technical polymer, NBR

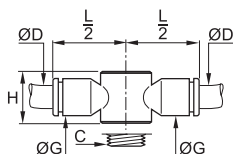

ØD	C		G	H	L/2	Kg
4	M5x0.8	3539 04 19	8.5	13	16	0.002
	G1/8	3539 04 10	10.5	14.4	20	0.008
6	G1/8	3539 06 10	10.5	14.4	20	0.011
	G1/4	3539 06 13	13.5	18	26	0.015
8	G1/4	3539 08 13	13.5	18	27	0.013
	G3/8	3539 08 17	16	21.5	30.5	0.020
10	G3/8	3539 10 17	16	21.5	31	0.016

3549 Twin Banjo Bodies

Technical polymer, NBR

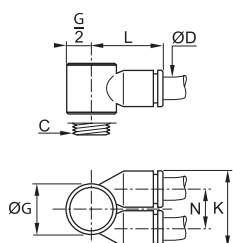

ØD	C		G	K	L	N	Kg
	M5x0.8	3549 04 19	10	17.5	15.5	9	0.003
4	G1/8	3549 04 10	14	22.5	20	12	0.007
	G1/4	3549 04 13	18.5	28	25	14.5	0.020
6	G1/8	3549 06 10	14	22.5	20.5	12	0.003
	G1/4	3549 06 13	18.5	28	25	14.5	0.015
	G3/8	3549 06 17	22.5	33	28.5	17	0.031
8	G1/4	3549 08 13	18.5	28	26	14.5	0.006
	G3/8	3549 08 17	22.5	33	29.5	17	0.020
10	G3/8	3549 10 17	22.5	33	29.5	17	0.009

Modular Banjo Fittings

3527 Single Banjo Bolts, Male BSPP and Metric Thread

Nickel-plated brass, NBR

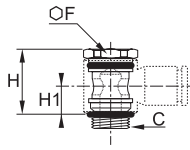

C		F	H	H1	Kg
M5x0.8	3527 00 19*	-	17	7.5	0.003
G1/8	3527 00 10	13	17	7.5	0.011
G1/4	3527 00 13	17	21	9.5	0.020
G3/8	3527 00 17	20	24.5	11	0.033
G1/2	3527 00 21	25	27.5	11.5	0.064

*With screwdriver slot
Full bore

3528 Stacking Banjo for 2 Body High Modules, Male BSPP and Metric Thread

Nickel-plated brass, NBR

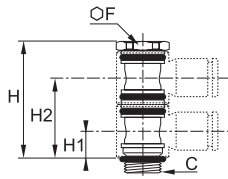

C		F	H	H1	H2	Kg
M5x0.8	3528 00 19*	-	24.5	7.5	18.5	0.005
G1/8	3528 00 10	13	31	7.5	22	0.017
G1/4	3528 00 13	17	39	9.5	27.5	0.031
G3/8	3528 00 17	20	46	11	32.5	0.053

*With screwdriver slot
Full bore
Designed for use with 2 banjo bodies

3529 Stacking Banjo for 3 Body High Modules, Male BSPP Thread

Nickel-plated brass, NBR

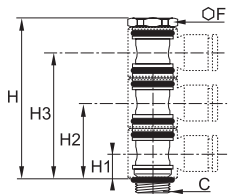

C		F	H	H1	H2	H3	Kg
G1/8	3529 00 10	13	45.5	7.5	22	36	0.023
G1/4	3529 00 13	17	54	9.5	27.5	45.5	0.042
G3/8	3529 00 17	20	67.5	11	32.5	54	0.069

Full bore
Designed for use with 2 banjo bodies

3524 Threaded Banjo Bolts, Male/Female BSPP and Metric Thread

Nickel-plated brass, NBR

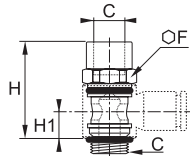

C		F	H	H1	Kg
M5x0.8	3524 00 19	8	17	7.5	0.005
G1/8	3524 00 10	13	24.5	7.5	0.013
G1/4	3524 00 13	17	33	9.5	0.027
G3/8	3524 00 17	20	37.5	11	0.039
G1/2	3524 00 21	26	42	11.5	0.067

Full bore

Banjo bolts 3527, 3528, 3529 and 3524 are only usable in association with the corresponding bodies for modular construction 3538, 3539 and 3549.

Thread and passage size for part numbers 3527, 3528, 3529 and 3524.

Thread	M5x0.8	G1/8	G1/4	G3/8	G1/2
DN	2.5	5.5	8.5	11	13

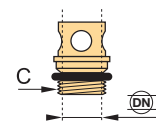

Modular Plug-In Connectors

These connectors allow a **maximum number of tube connections** in a **minimum of space**. Parker Legris offers an **ergonomic solution** to enable quick connection for the most complex installations.

Product Advantages

- Panel-Mounted**
 - Panel mounted to a machine or bulkhead
 - Reduced risk of incorrect assembly
 - Possible to connect in-line
 - Plated metal joiners and clips for reinforcement
- In-Line**
 - Locating pin prevents incorrect assembly
 - Cap guides the tubes and protects connections
 - Aluminium and technical polymer components
 - Bulkhead mountable
 - Customised multi-connectors upon request
- DIN Rail**
 - Used alongside electrical connectors
 - Pressure indication
 - Can be clipped side-by-side into a DIN rail profile [or Ω
 - Channels or slots for labels for tube identification



Robotics
Automotive Process
Pneumatics
Semi-Conductors
Textile
Packaging

Applications

Technical Characteristics

Compatible Fluids	Compressed air Other fluids: please consult us
Working Pressure	Vacuum to 10 bar
Working Temperature	-20°C to +80°C

Reliable performance is dependent upon the type of fluid conveyed, component materials and tubing being used.
Use is guaranteed with a vacuum of 755 mm Hg (99% vacuum).

Component Materials

- Multi-connectors:**
- panel-mounted: zinc-plated steel, technical polymer
 - in-line: aluminium, technical polymer
 - DIN rail: technical polymer

Connections: LF 3000®



Silicone-free

Installation Configurations

Panel-Mounted

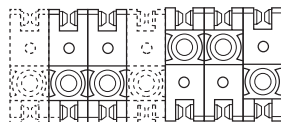

Standard assembly Customised assembly

A box contains:

- 10 units
- 20 joining clips and 4 end pins
- 4 mounting brackets
- 4 coupling clips
- 1 dismantling tool

The module is constructed from a number of symmetrical components connected by joining clips. A coupling clip locks the module closed. A dismantling tool allows disconnection.

Maximum 5 modules recommended for the mating module; the fixed module is not limited.

In-Line



Regulations

ISO 14743: Pneumatic fluid power, push-in connectors for thermoplastic tubes
DI: 97/23/EC (PED)
DI: 2002/95/EC (RoHS), 2011/65/EC
DI: 1907/2006 (REACH)

DIN Rail Connector

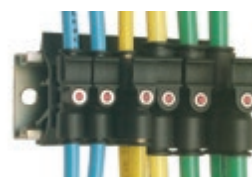

Modular Plug-In Connectors

3300 Modular Plug-In Connector

Technical polymer, NBR

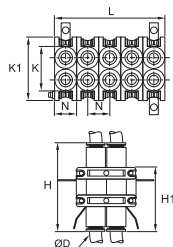

ØD		B	H	H1	K	K1	L	L1	L2	N	Kg
4	3300 04 00	21	40.5	29.5	32	20	55	22	6	11	0.078
6	3300 06 00	28	48	38.5	39	27.5	70	28	7.5	14	0.213
8	3300 08 00	28	50	39	39	27.5	70	28	7.5	14	0.124

Clearance hole for Ø3 mm screw

3320 Multi-Connector Male Screw Body

Technical polymer, NBR

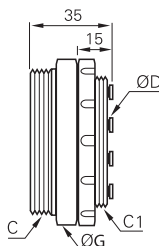

ØD	C	C1		Number of Outlets	G	Kg
4	M38x1.5	M32x1.5	3320 04 00 02	2	42	0.046
	M46x1.5	M40x1.5	3320 04 00 04	4	50	0.070
		M40x1.5	3320 04 00 07	7	50	0.072
6	M65x1.5	M58x1.5	3320 04 00 12	12	70	0.137
	M38x1.5	M32x1.5	3320 06 00 02	2	42	0.050
		M46x1.5	M40x1.5	3320 06 00 04	4	50
	M40x1.5		3320 06 00 07	7	50	0.072
8	M38x1.5	M32x1.5	3320 08 00 02	2	45	0.050

The number of male body outlets must correspond to the same number of outlets on the female body.

3321 Multi-Connector Female Screw Body

Technical polymer, NBR

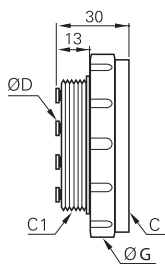

ØD	C	C1		Number of Outlets	G	Kg
4	M38x1.5	M32x1.5	3321 04 00 02	2	45	0.040
	M46x1.5	M40x1.5	3321 04 00 04	4	55	0.065
		M40x1.5	3321 04 00 07	7	55	0.064
6	M65x1.5	M58x1.5	3321 04 00 12	12	75	0.125
	M38x1.5	M32x1.5	3321 06 00 02	2	45	0.043
		M46x1.5	M40x1.5	3321 06 00 04	4	55
	M40x1.5		3321 06 00 07	7	55	0.064
8	M38x1.5	M32x1.5	3321 08 00 02	2	45	0.042

The number of female body outlets must correspond to the same number of outlets on the male body.

3329 Multi-Connector Screw Cap

Technical polymer

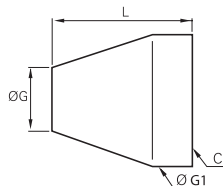

C		Number of Outlets	G	G1	L	Kg
M32x1.5	3329 00 01	2	32	42	50	0.043
M40x1.5	3329 00 02	4-7	35	50	55	0.058
M58x1.5	3329 00 03	12	34	70	70	0.139

Overall Dimensions for Bulkhead Mounting

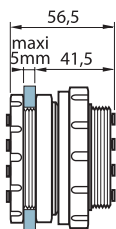
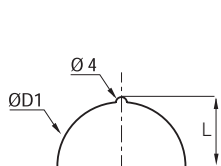

Number of Outlets	L	ØD1
2	17	32.5
4-7	21	40.5
12	30.3	58.5

Modular Plug-In Connectors

3379 DIN Rail Connector for 2 Tubes

Technical polymer, NBR

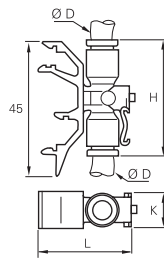

ØD		H	K	L	Kg
4	3379 04 00	34.5	11	39.5	0.010
6	3379 06 00	34.5	11	39.5	0.006
8	3379 08 00	46	13	44.5	0.034

Start pressure test point on the system

3381 DIN Rail Connector for 3 Tubes

Technical polymer, NBR

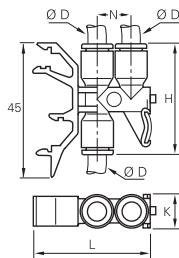

ØD		H	K	L	N	Kg
4	3381 04 00	36.5	11	39.5	11.5	0.012
6	3381 06 00	36.5	11	39.5	11.5	0.028
8	3381 08 00	46	13	44.5	14.5	0.033

Start pressure test point on the system



IP 65
24 V DC
R 450 007 195
Pe max = 10 bar

Self-Sealing and Oscillating Fittings

Parker Legris has developed these two **innovative** push-in fittings in order to integrate various functions and allow **quick installation** on pneumatic circuits.

Product Advantages

Self-Sealing Fittings

Prevents fluid flow when there is no tube connected
Circuits may remain pressurised when being checked and maintained
When connected, the compressed air flow is restored in both directions

Oscillating Fittings

Rotation matched to cylinder rod stroke
Prevents tube wear due to excessive flexing
Optimum reliability and durability
Simplifies circuit assembly



Robotics
Automotive Process
Pneumatics
Semi-Conductors
Textile
Packaging

Applications

Technical Characteristics

Compatible Fluids	Compressed air Other fluids: please consult us
Working Pressure	Vacuum to 20 bar (10 bar: self-sealing fitting)
Working Temperature	-20°C to +80°C

Reliable performance is dependent upon the type of fluid conveyed, component materials and tubing being used.
Use is guaranteed with a vacuum of 755 mm Hg (99% vacuum).

Component Materials

Swivel Fitting

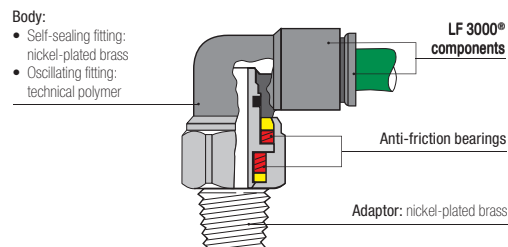

Silicone-free

Regulations

ISO 14743: Pneumatic fluid power, push-in connectors for thermoplastic tubes

DI: 2002/95/EC (RoHS),
2011/65/EC

DI: 97/23/EC (PED)

DI: 1907/2006 (REACH)

Installation Configurations

Self-Sealing Fitting

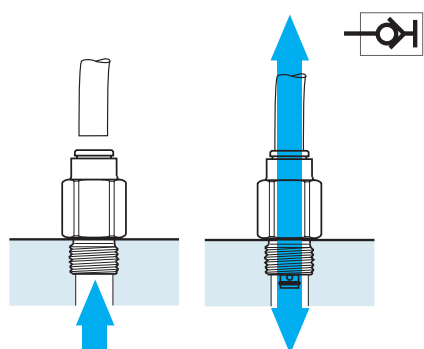

Oscillating Fitting

Tube O.D. (mm)	Torque (daN.m)	Max. Rotation Speed (turn/min.)
4	$2.5 \cdot 10^{-3}$	190
6	$4 \cdot 10^{-3}$	160
8	$7 \cdot 10^{-3}$	120
10	$11 \cdot 10^{-3}$	90
12	$16 \cdot 10^{-3}$	80

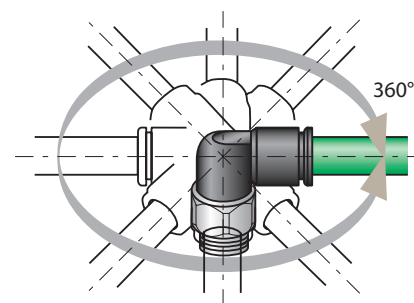

Self-Sealing and Oscillating Fittings

3391 Self-Sealing Stud Fitting, Male BSPP Thread

Nickel-plated brass, NBR

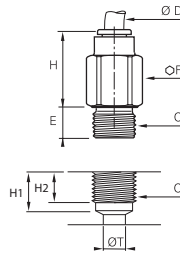

ØD	C		E	F	H	H1	H2	ØT	Kg
4	G1/8	3391 04 10	5	13	18	7.5	6	5	0.017
6	G1/8	3391 06 10	5	14	19.5	9	6	7.5	0.018
8	G1/8	3391 08 10	5	14	29.5	10	6	7.5	0.025
	G1/4	3391 08 13	5.5	16	25.5	11	8	9	0.032
10	G3/8	3391 10 17	5.5	20	27.5	13	11	10	0.054

Maximum working pressure: 10 bar

3091 Self-Sealing Stud Fitting, Male BSPT Thread

Nickel-plated brass, NBR

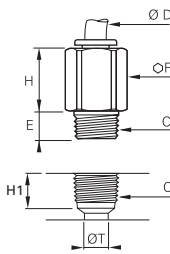

ØD	C		E	F	H	H1	ØT	Kg
4	R1/8	3091 04 10	7.5	12	18	9.5	5	0.014
6	R1/8	3091 06 10	7.5	13	19.5	9.5	7.5	0.015
8	R1/8	3091 08 10	6.5	14	25	10.5	7.5	0.024
	R1/4	3091 08 13	11	14	25.5	13.5	9	0.021
10	R3/8	3091 10 17	11.5	17	27.5	14	10	0.035

Maximum working pressure: 10 bar

3160 Self-Sealing Plug-In Fitting

Technical polymer, NBR

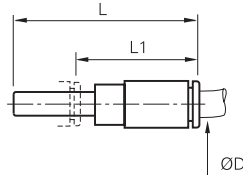

ØD		L	L1	Kg
4	3160 04 00	46	33.5	0.006
6	3160 06 00	53.5	31	0.009
8	3160 08 00	58	31	0.014

3159 Oscillating Elbow, Male BSPT Thread

Technical polymer, nickel-plated brass, NBR

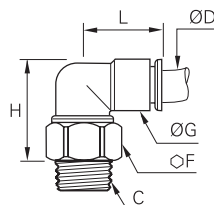

ØD	C		F	G	H	L	Kg
4	R1/8	3159 04 10	12	11	22	17.5	0.013
	R1/8	3159 06 10	14	14	26.5	20.5	0.020
6	R1/4	3159 06 13	14	14	23.5	20.5	0.022
	R1/8	3159 08 10	17	16	32	23.5	0.034
8	R1/4	3159 08 13	17	16	29	23.5	0.034
	R3/8	3159 08 17	17	16	25	23.5	0.031
10	R1/4	3159 10 13	19	19.5	37.5	29	0.051
	R3/8	3159 10 17	19	19.5	33.5	29	0.045
12	R1/4	3159 12 13	21	22	44.5	33.5	0.074
	R3/8	3159 12 17	21	22	41	33.5	0.067

Pre-coated thread

3189 Oscillating Elbow, Male BSPP and Metric Thread

Technical polymer, nickel-plated brass, NBR

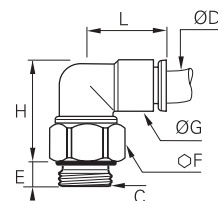

ØD	C		E	F	G	H	L	Kg
4	M5x0.8	3189 04 19	3	12	11	24.5	17.5	0.012
	G1/8	3189 04 10	5	13	11	23	17.5	0.014
	M5x0.8	3189 06 19	3	12	14	27.5	20.5	0.017
6	G1/8	3189 06 10	5	14	14	27	20.5	0.020
	G1/4	3189 06 13	5.5	16	14	25.5	20.5	0.023
	G1/8	3189 08 10	5	17	16	33.5	23.5	0.034
8	G1/4	3189 08 13	5.5	17	16	31	23.5	0.032
	G3/8	3189 08 17	5.5	20	16	29.5	23.5	0.039
	G1/4	3189 10 13	5.5	19	19.5	39	29	0.053
10	G3/8	3189 10 17	5.5	20	19.5	37	29	0.050
	G1/4	3189 12 13	5.5	21	22	46.5	33.5	0.073
12	G3/8	3189 12 17	5.5	21	22	45.5	33.5	0.071

Accessories for Push-In Fittings

Parker Legris has designed these different accessories to improve **safety** and circuit **identification**.

Product Advantages

Safety | Protection of operators and equipment
Prevents accidental disconnection
Disconnection only possible with tooling
Resistance to grease and cleaning agents

Ergonomic | Colour-coding for fluid circuit identification (6 colours)
Setting and fixing of your circuits thanks to clips and release button covers
Easy disconnection with tool where access is difficult
Adapted to meet all installation configurations



Robotics
Automotive Process
Pneumatics
Semi-Conductors
Textile
Water Treatment
Beverage Dispensers

Applications

Technical Characteristics

Compatible Ranges	LF 3000®, LIQUIfit®
Working Temperature	-20°C to +95°C
Component Materials	Tamper-proof safety clip, release button cover, clip: technical polymer Reducer and plug: nickel-plated brass

Installation Process

Tamper-Proof Safety Clip



Coloured Release Button Covers

Coloured release button covers can be mounted on LF 3000® and LIQUIfit® fittings, supplied fitted with manual release buttons.

5 colours are available and allows colour coding to be used throughout circuits.



Disconnection Tool

In cases where access is difficult, this tool can be particularly useful.



Clip Strips

Clips are also designed to fix LF 3000® fittings in series within a minimum of space.



The complete range of accessories can be found in Chapter 9.

Accessories for Push-In Fittings

3130 Tamper-Proof Safety Clip

Technical polymer

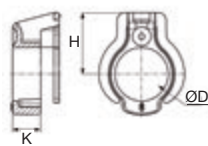

ØD							H	K	kg
4	3130 04 01	3130 04 02	3130 04 03	3130 04 04	3130 04 05	3130 04 10	6.6	3	0.001
6	3130 06 01	3130 06 02	3130 06 03	3130 06 04	3130 06 05	3130 06 10	7.8	3.1	0.001
8	3130 08 01	3130 08 02	3130 08 03	3130 08 04	3130 08 05	3130 08 10	9.5	4.3	0.001
10	3130 10 01	3130 10 02	3130 10 03	3130 10 04	3130 10 05	3130 10 10	10.8	4.2	0.002
12	3130 12 01	3130 12 02	3130 12 03	3130 12 04	3130 12 05	3130 12 10	12.5	5.1	0.003
14	3130 14 01	3130 14 02	3130 14 03	3130 14 04	3130 14 05	3130 14 10	15	6	0.004

CLIP Clip Strip for Tubes and Fittings

Technical polymer

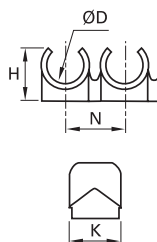

ØD		Number of Outlets	H	K	N	Kg
4	CLIP 04 00	8	9	13.5	10.5	0.007
6	CLIP 06 00	8	10.5	13	10.5	0.008
8	CLIP 08 00	7	12.5	10.5	12	0.007
10	CLIP 10 00	6	14	12	15	0.005
12	CLIP 12 00	5	16.5	14	16.5	0.009
14	CLIP 14 00	4	18	16	20.5	0.009

Delivered in boxes of 10 strips of the same diameter (complete with self-tapping screws of 95 mm length). These clips can be used with metric or inch tubing.

3000 70 Dismounting Tool

Treated steel

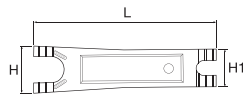

	H	H1	L	Kg
3000 70 00	25	20	96	0.021

For dismounting LF 3000® tubing/fittings where access is difficult, we recommend the use of this dismounting tool.

3110 Coloured Release Button Covers

Technical polymer



ØD						kg
4	3110 04 00	3110 04 02	3110 04 03	3110 04 04	3110 04 05	0.001
6	3110 06 00	3110 06 02	3110 06 03	3110 06 04	3110 06 05	0.001
8	3110 08 00	3110 08 02	3110 08 03	3110 08 04	3110 08 05	0.001
10	3110 10 00	3110 10 02	3110 10 03	3110 10 04	3110 10 05	0.001
12	3110 12 00	3110 12 02	3110 12 03	3110 12 04	3110 12 05	0.001
14	3110 14 00	3110 14 02	3110 14 03	3110 14 04	3110 14 05	0.002

0178 Reducer, Male/Female BSPP and Metric Thread

Nickel-plated brass, NBR

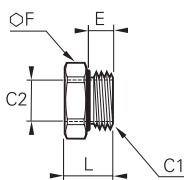

C1	C2		E	F	L	Kg
M7x1	M5x0.8	0178 55 19	5	10	12	0.005
G1/8	M5x0.8	0178 10 19	5	13	9	0.005
G1/4	G1/8	0178 13 10	5.5	16	9.5	0.006
G3/8	G1/8	0178 17 10	5.5	20	10.5	0.016
	G1/4	0178 17 13	5.5	20	10.5	0.011
G1/2	G1/4	0178 21 13	7.5	24	12.5	0.024
	G3/8	0178 21 17	7.5	24	12.5	0.016
G3/4	G1/2	0178 27 21	7.5	32	13.5	0.035

With integrated O-ring seal

0222 Internal Hex Plug, Male BSPP and Metric Thread

Nickel-plated brass, NBR

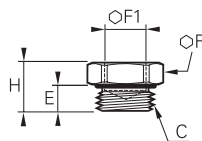

C		E	F	F1	H	Kg
M5x0.8	0222 19 00	3.5	8	2.5	7	0.002
M7x1	0222 55 00	5	10	3	8.5	0.003
G1/8	0222 10 00	5	13	5	8.5	0.006
G1/4	0222 13 00	5.5	16	6	9.5	0.010
G3/8	0222 17 00	5.5	20	8	10.5	0.019
G1/2	0222 21 00	7.5	24	10	12	0.031

With integrated O-ring seal



LF 3200 (3 mm) Push-In Fittings Range

Stud Fittings

3281 Metric Page 1-41	3299 Metric Page 1-41	3229 Metric Page 1-41	3298 Metric Page 1-41	3293 Metric Page 1-41	3218 Metric Page 1-42
------------------------------------	------------------------------------	------------------------------------	------------------------------------	------------------------------------	------------------------------------



Tube-to-Tube Fittings and Accessories

3206 Straight Page 1-43	3202 Elbow Page 1-43	3204 Tee Page 1-43	3266 Reducer Page 1-43	3226 Plug Page 1-43
--------------------------------------	-----------------------------------	---------------------------------	-------------------------------------	----------------------------------



LF 3200 Push-In Fittings (3 mm)

Miniature pneumatic installations are very precise and sensitive systems, having specific operating characteristics. Consequently, Parker Legris has developed this **ergonomic** range of brass push-in fittings for its **mechanical robustness** and **compactness**.

Product Advantages

Compact & Lightweight	25% smaller than other fittings on the market for optimum actuator dimensions Minimum weight for maximum efficiency Reduces energy consumption and limits actuator wear
Resistance & Performance	All brass components for excellent impact resistance Gripping system with collet for increased robustness and service life Excellent resistance to high operating pressures
Reliability	100% leak-tested in production Date coding to guarantee quality and traceability Ideal for very sensitive applications Corrosion-resistant



Pneumatic Panels
Robotics
Semi-Conductors
Textile
Pneumatics
Vacuum

Applications

Technical Characteristics

Compatible Fluids	Compressed air
Working Pressure	Vacuum to 20 bar
Working Temperature	-15°C to +80°C
Tightening Torque (daN.m)	0.01 to 0.1

Reliable performance is dependent upon the type of fluid conveyed, component materials and tubing being used.
Use is guaranteed with a vacuum of 755 mm Hg (99% vacuum).

Component Materials

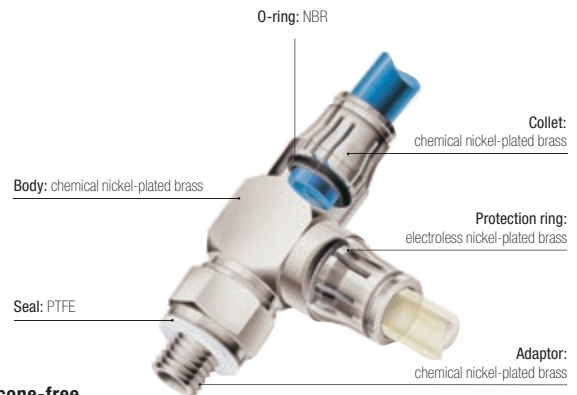

Silicone-free

Regulations

ISO 14743 ISO 14743: Pneumatic fluid power, push-in connectors for thermoplastic tubes

DI: 97/23/EC (PED)
DI: 2002/95/EC (RoHS), 2011/65/EC
DI: 94/9/EC (ATEX)
RG: 1907/2006 (REACH)

Installation Configurations

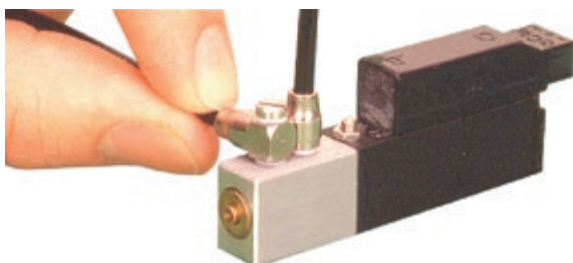

The LF 3200 fitting, connected with a 3 mm polyurethane or antistatic polyurethane tube, is the perfect solution for compact installations:

- which are highly stressed
- whose reliability is critical

Stud Fittings

3281 Stud Fitting, Male Metric Thread

Nickel-plated brass, NBR

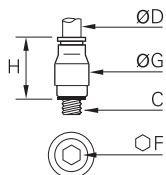

ØD	C		F	G	H	Kg
3	M3x0.5	3281 03 09	1.5	6	9.5	0.001
	M5x0.8	3281 03 19	1.5	8	9.5	0.002

3299 Compact Stud Elbow, Male Metric Thread

Nickel-plated brass, NBR

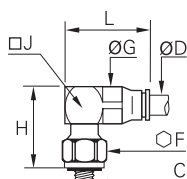

ØD	C		F	G	H	J	L	Kg
3	M3x0.5	3299 03 09	6	6	13.5	6	13.5	0.004
	M5x0.8	3299 03 19	8	6	13	6	13.5	0.005

3229 Extended Stud Elbow, Male Metric Thread

Nickel-plated brass, NBR

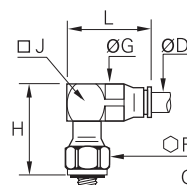

ØD	C		F	G	H	J	L	Kg
3	M3x0.5	3229 03 09	6	6	16	6	13.5	0.004
	M5x0.8	3229 03 19	8	6	17	6	13.5	0.005

3298 Stud Branch Tee, Male Metric Thread

Nickel-plated brass, NBR

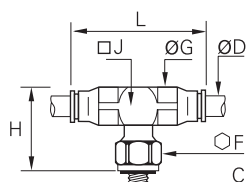

ØD	C		F	G	H	J	L	Kg
3	M3x0.5	3298 03 09	6	6	13.5	6	20.5	0.004
	M5x0.8	3298 03 19	8	6	13	6	20.5	0.005

3293 Stud Run Tee, Male Metric Thread

Nickel-plated brass, NBR

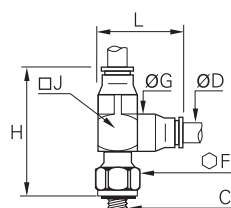



ØD	C		F	G	H	J	L	Kg
3	M3x0.5	3293 03 09	6	6	20	6	13.5	0.004
	M5x0.8	3293 03 19	8	6	20	6	13.5	0.005

Stud Fittings

3218 Single Banjo, Male Metric Thread

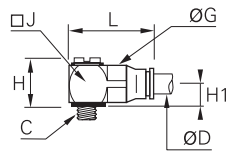
Nickel-plated brass, NBR



ØD	C		G	H	H1	J	L	Kg
3	M3x0.5	 3218 03 09	6	9.5	4	6	12.5	0.002
	M5x0.8	 3218 03 19	6	10.5	4.5	8	15	0.005

Tube-to-Tube Fittings and Accessories

3206 Equal Tube/Tube Connector

Nickel-plated brass, NBR

ØD		G	L	Kg
3	 3206 03 00	6	17	0.002

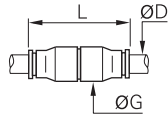

3202 Equal Elbow

Nickel-plated brass, NBR

ØD		G	J	L	Kg
3	 3202 03 00	6	6	13.5	0.003

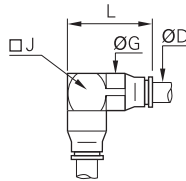

3204 Equal Tee

Nickel-plated brass, NBR

ØD		G	H	J	L	L1	Kg
3	 3204 03 00	6	13.5	6	20.5	10.5	0.004

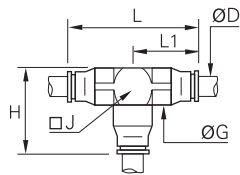

3266 Plug-In Reducer

Nickel-plated brass, NBR, technical polymer

ØD	ØD1		G	L	L1	Kg
3	4	 3266 03 04	6	28	19	0.001

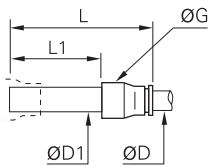

3226 Blanking Plug

Nickel-plated brass

ØD		L	L1	Kg
3	 3226 03 00	20	10	0.001

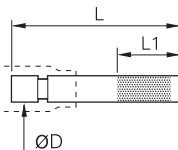

Range of LIQUIfit® Push-In Fittings

Stud Fittings

Straights

6505
BSPT
Page 1-48



6315
BSPT
Page 1-48



6353
BSPP
Page 1-49



6521
BSPT
Page 1-50



Straights - Inch

6505
BSPT/NPTF
Page 1-48



6315
NPTF
Page 1-49



6353
BSPP
Page 1-49



6352
BSPP
Page 1-49



6325
UNS
Page 1-49



6521
BSPT/NPTF
Page 1-50



Carstick®

6300
Page 1-50



Carstick® - Inch

6300
Page 1-50



Elbows

6579
BSPT
Page 1-51



6509
BSPT
Page 1-51



Elbows - Inch

6579
BSPT/NPTF
Page 1-51



6509
BSPT/NPTF
Page 1-52



Tees

6508
BSPT
Page 1-52



6503
BSPT
Page 1-53



Tees - Inch

6508
BSPT/NPTF
Page 1-53



6503
BSPT/NPTF
Page 1-53



Plugs

6355
BSPT
Page 1-53



Tube-to-Tube Fittings

Straight

6306
Page 1-54



Straight - Inch

6306
Page 1-54



Elbow

6302
Page 1-54



Elbow - Inch

6302
Page 1-54



Tee

6304
Page 1-55



Tee - Inch

6304
Page 1-55



Y

6340
Page 1-55



Y - Inch

6340
Page 1-55



Cross

6307
Page 1-56



Cross - Inch

6307
Page 1-56



Bulkhead Connectors

Straight

6316
Page 1-56



Straight - Inch

6316
Page 1-56



Plug-In Fittings and Accessories

Elbows

6382
Page 1-57



6380
Page 1-57



6382
Page 1-57



Tees

6383
Page 1-57



6388
Page 1-57



6388
Page 1-58



Tee - Inch

Accessories

6366
Page 1-58



6326
Page 1-58



6322
Page 1-59



6351
Page 1-59



Accessories - Inch

6366
Page 1-58



6368
Page 1-58



6326
Page 1-59



6322
Page 1-59



6351
Page 1-59

















Range of LIQUIfit+ Push-In Fittings

Stud Fittings		Tube-to-Tube Fittings		Plug-In Fittings
Straight - Inch		Straight - Inch	Elbow - Inch	Elbow - Inch
6333 BSPP Page 1-63		6336 BSPP Page 1-63	6332 BSPP Page 1-63	6331 BSPP Page 1-63
				

LIQUIfit® and LIQUIfit+ Accessories		
3130 Page 1-60	3110 Page 1-60	0605 Page 1-60
		

Range of LIQUIfit® Push-In Fittings with Metal Adaptor

Stud Fittings with Stainless Steel Adaptor							
Straights		Elbows		Tees			
6911 BSPP Page 1-65	6975 BSPT Page 1-65	6959 BSPP Page 1-65	6979 BSPT Page 1-66	6958 BSPP Page 1-66	6978 BSPT Page 1-66	6953 BSPP Page 1-67	6973 BSPT Page 1-67
							

Stud Fittings with Nickel-Plated Brass Adaptor							
Straights		Elbows		Tees			
6901 BSPP Page 1-68	6905 BSPT Page 1-68	6999 BSPP Page 1-68	6909 BSPT Page 1-69	6998 BSPP Page 1-69	6908 BSPT Page 1-69	6993 BSPP Page 1-70	6903 BSPT Page 1-70
							

Part Number Construction

Example: 6505 08 17WP2

6505	08	17	W	P2
Article Type 65XX = LIQUIfit® (without pre-coating) 63XX = LIQUIfit® 69XX = LIQUIfit® with metal adaptors 633X = LIQUIfit+	Tube O.D. 4 6 8 10 12	Thread Code 10: 1/8 BSPT 13: 1/4 BSPT 17: 3/8 BSPT 21: 1/2 BSPT 27: 3/4 BSPT	Colour W = White	Packaging P2 = Standard (< 10 pieces) P3 = High volumes (≤ 100 pieces) (on request, please consult us)-w

Product Type
XX05 = Male Stud Fitting
XX79 = Fixed Elbow

LIQUIfit® Push-In Fittings

This "eco-designed" range proposes an **innovative alternative** for water applications; **no fluid contamination** occurs and **environmental protection is guaranteed**. These fittings ensure **reliable and compact** connections for **liquid transfer** applications.

Product Advantages

Innovative Technology & Concept

Ergonomic and aesthetic design
 The most compact product on the market for water, beverages and liquid foodstuffs
 Easy-to-clean external surfaces
 Push-in connection and disconnection
 Full flow
 Use with a pre-prepared metallic tubing
 Gripping system preventing any pumping effect
 Eco-designed (materials, manufacturing process, weight, dimensions and performance)

Optimal Performance

Patented sealing technology
 100% leak-tested in production
 Date coding to guarantee quality and traceability
 Wide range of shapes and numerous configurations

High Performance Material

Bio-sourced polymer meeting the most severe food process regulations
 Suitable for contact with water and beverages
 Excellent chemical and mechanical resistance, even at high temperature
 Free of bisphenol A and phthalates, conforming with regulations



Hot & Cold Drinks Dispensers
 Neutral Gases
 Cooling Systems
 Food Process
 Water Purification Systems
 Water Dispensers
 Medical

Applications

Technical Characteristics

Compatible Fluids	Water, beverages, CO ₂ (inert use) Chemical fluids: please consult us		
Working Pressure	Vacuum to 16 bar		
Working Temperature	-10°C to +95°C		
Tightening Torques (BSPT/NPTF)	Thread	1/8" and 1/4"	3/8" and 1/2"
	daN.m	0.15	0.30

Reliable performance is dependent upon the type of fluid conveyed, component materials and tubing being used.
 Use is guaranteed with a vacuum of 755 mm Hg (99% vacuum).

Component Materials

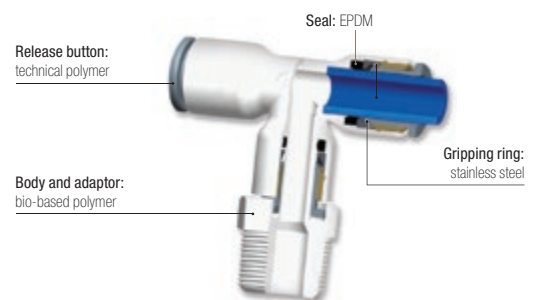

Silicone-free

Regulations

DI: 2002/95/EC (RoHS), 2011/65/EC
 RG: 1935/2004/EC
 RG: 1907/2006 (REACH)
 FDA: 21 CFR
 NSF 51 at 95°C
 NSF/ANSI 61 - C HOT

DM 174
 WRAS
 ACS

Pressure and Temperature of the Different Diameters and Related Products of the LIQUIfit® Range

-10°C		Pressure (bar)	
mm Ø	inch Ø	Fittings	Tubing
4	5/32	16	16
6	1/4	16	16
8	5/16	16	16
10	3/8	13	15
12	1/2	11	11

+1°C		Pressure (bar)	
mm Ø	inch Ø	Fittings	Tubing
4	5/32	16	16
6	1/4	16	16
8	5/16	16	16
10	3/8	13	15
12	1/2	11	11

+20°C		Pressure (bar)	
mm Ø	inch Ø	Fittings	Tubing
4	5/32	16	16
6	1/4	16	16
8	5/16	16	16
10	3/8	13	15
12	1/2	11	11

+40°C		Pressure (bar)	
mm Ø	inch Ø	Fittings	Tubing
4	5/32	16	16
6	1/4	16	16
8	5/16	16	16
10	3/8	13	15
12	1/2	11	11

+65°C		Pressure (bar)	
mm Ø	inch Ø	Fittings	Tubing
4	5/32	10	10
6	1/4	10	10
8	5/16	10	10
10	3/8	7	7
12	1/2	7	7

+95°C		Pressure (bar)	
mm Ø	inch Ø	Fittings	Tubing
4	5/32	4	4
6	1/4	4	4
8	5/16	4	4
10	3/8	4	4
12	1/2	4	4

Environmental Footprint

Example: representation of the environmental footprint of an equal tube-to-tube connector

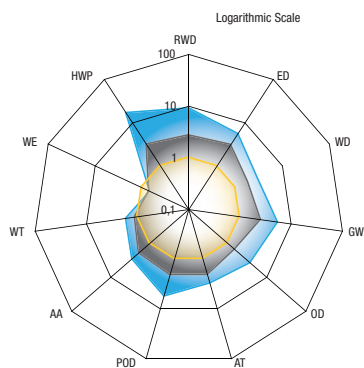

Tube-to-Tube Connector
 ■ Market Standard in POM
 ■ Market Standard in PP
 ■ Parker Legris

LIQUIfit® Tube-to-Tube Connector



Market Standard Tube-to-Tube Connector

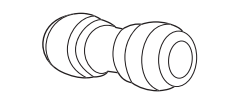

Environmental Approach

The Life Cycle Analysis (LCA) offers a true alternative in terms of environmental differentiation.

We carried out a comparative LCA on the market of drinking water between 3 Parker Legris fittings and the standard products on the market.

This analysis relies on ISO 14020, ISO 14025 and IEC PAS 62545 standards and the results are presented in a report approved by an ethics committee (Bureau Veritas).



RWD: Raw Material Depletion
 ED: Energy Depletion
 WD: Water Depletion
 GW: Global Warming
 OZ: Ozone Depletion
 AT: Air Toxicity

POC: Photochemical Ozone Creation
 AA: Air Acidification
 WT: Water Toxicity
 WE: Water Eutrophication
 HWP: Hazardous Waste Production

Sealing Profile for Female Thread Stud Fitting

Stud Fitting,
Female NPTF Thread
6315

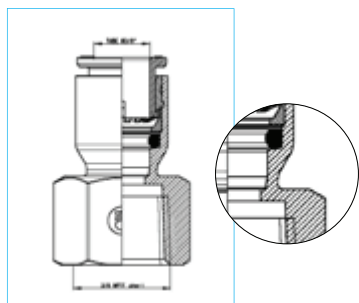

Stud Fitting Flat Type,
Female BSPP Thread,
6352 and 6333

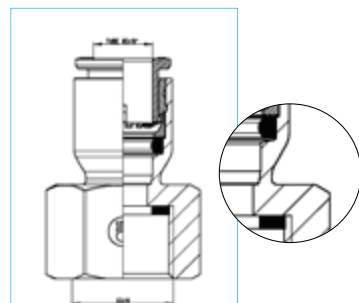

Tap Connector Cone Type,
Female BSPP Thread,
6353

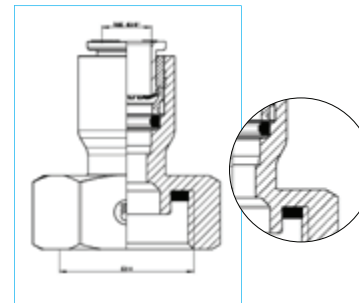

Stud Fittings

6505 Stud Fitting, Male BSPT Thread



Bio-based polymer, EPDM

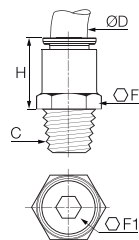

ØD	C			F	F1	H	kg
4	R1/8	6505 04 10WP2		11	3	18	0.003
	R1/4	6505 04 13WP2		14	3	18	0.004
6	R1/8	6505 06 10WP2	6505 06 10WP3	11	4	18	0.002
	R1/4	6505 06 13WP2	6505 06 13WP3	14	4	18	0.004
8	R1/8	6505 08 10WP2	6505 08 10WP3	17	6	20	0.004
	R1/4	6505 08 13WP2	6505 08 13WP3	14	6	20	0.004
	R3/8	6505 08 17WP2	6505 08 17WP3	17	6	20	0.005
10	R1/4	6505 10 13WP2	6505 10 13WP3	17	7	21.5	0.005
	R3/8	6505 10 17WP2	6505 10 17WP3	19	7	21.5	0.007
12	R1/2	6505 10 21WP2		22	7	21.5	0.010
	R3/8	6505 12 17WP2	6505 12 17WP3	19	9	24.5	0.008
	R1/2	6505 12 21WP2	6505 12 21WP3	22	9	24.5	0.012

WP3 = high volumes (number of parts per bag: 40, 50 or 100, depending on the diameters)
Thread without pre-coating

6505 Stud Fitting, Male NPTF Thread



Inch

Bio-based polymer, EPDM

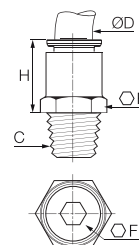

ØD	C			F	F1	H	kg
1/4	NPT1/8	6505 56 11WP2		1/2	5/32	17	0.002
	NPT1/4	6505 56 14WP2	6505 56 14WP3	9/16	5/32	17	0.003
3/8	NPT1/4	6505 60 14WP2		3/4	1/4	22	0.006
	NPT3/8	6505 60 18WP2		3/4	1/4	22	0.007
1/2	NPT3/8	6505 62 18WP2		15/16	3/8	28	0.012
	NPT1/2	6505 62 22WP2		15/16	3/8	28	0.013

WP3 = high volumes (number of parts per bag: 40, 50 or 100, depending on the diameters)
Thread without pre-coating

6505 Stud Fitting, Male BSPT Thread



Inch

Bio-based polymer, EPDM

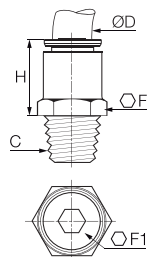

ØD	C			F	F1	H	kg
1/4	R1/8	6505 56 10WP2		11	5	17	0.002
	R1/4	6505 56 13WP2		14	5	17	0.003
3/8	R1/4	6505 60 13WP2		17	7	22	0.006
	R3/8	6505 60 17WP2		19	7	22	0.006
1/2	R1/2	6505 60 21WP2		22	7	28	0.012
	R3/8	6505 62 17WP2		24	9	28	0.014
	R1/2	6505 62 21WP2		24	9	28	0.017

Thread without pre-coating.
5/32" (4mm) and 5/16" (8mm) also available.

6315 Stud Connector, Female BSPT Thread



Bio-based polymer, EPDM

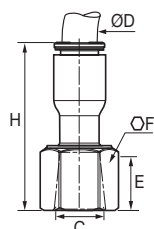

ØD	C			E	F	H	kg
6	R1/8	6315 06 10WP2		11	13	32	0.003
	R1/4	6315 06 13WP2	6315 06 13WP3	14	16	33	0.004
8	R1/4	6315 08 13WP2	6315 08 13WP3	14	16	33.5	0.004
	R3/8	6315 08 17WP2	6315 08 17WP3	14	20	36	0.009

WP3 = high volumes (number of parts per bag: 40, 50 or 100, depending on the diameters).

Stud Fittings

6315 Stud Fitting, Female NPTF Thread



Bio-based polymer, EPDM

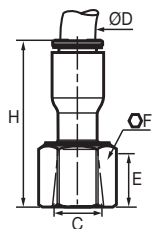

ØD	C		F	H	kg
1/4	NPT1/4	6315 56 14WP2	11/16	30	0.003
3/8	NPT3/8	6315 60 18WP2	13/16	36	0.007

See sealing profile page 1-47.

6353 Tap Connector Cone Type, Female BSPP Thread



Bio-based polymer, EPDM

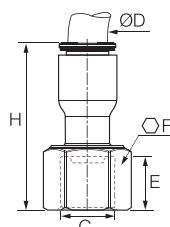

ØD	C		E	F	H	kg
6	G3/4	6353 06 27WP2	10	32	32	0.011
8	G3/4	6353 08 27WP2	10	32	40.5	0.017
10	G1/2	6353 10 21WP2	12	27	36	0.011

See sealing profile page 1-47.

6353 Tap Connector Cone Type, Female BSPP Thread



Bio-based polymer, EPDM

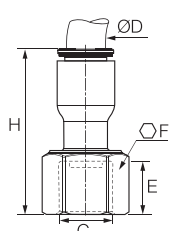

ØD	C		E	F	H	kg
1/4	G3/4	6353 56 27WP2	10	32	31	0.006
3/8	G1/2	6353 60 21WP2	12	27	36	0.011
	G3/4	6353 60 27WP2	10	32	41	0.018
1/2	G3/4	6353 62 27WP2	10	32	44.5	0.014

See sealing profile page 1-47.

6352 Stud Fitting Flat Type, Female BSPP Thread



Bio-based polymer, EPDM

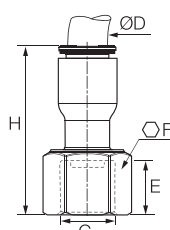

ØD	C		E	F	H	kg
8	G1/2	6352 08 21WP2	10.5	27	35.5	0.009
	G5/8	6352 08 23WP2	10.5	29	32	0.013
3/8	G3/8	6352 60 17WP2	12	22	36	0.008
	G1/2	6352 60 21WP2	12	27	36	0.011
1/2	G5/8	6352 62 23WP2	10.5	29	35.5	0.013

See sealing profile page 1-47.

6325 Faucet Connector, Female UNS Thread



Bio-based polymer, EPDM

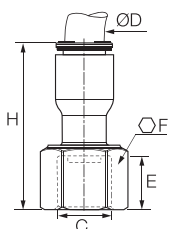

ØD	C		E	F	H	kg
1/4	UNS7/16-24	6325 56 133WP2	7	9/16	31	0.002
3/8	UNS7/16-24	6325 60 133WP2	7	9/16	32	0.004

See sealing profile page 1-47.

Stud Fittings

6521 Stud Standpipe, Male BSPT Thread



Bio-based polymer

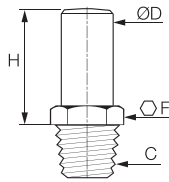

ØD	C		F	H	kg
6	R1/8	6521 06 10WP2	13	19	0.002
	R1/4	6521 06 13WP2	14	19	0.003
	R3/8	6521 06 17WP2	17	19	0.004
8	R1/8	6521 08 10WP2	19	23	0.003
	R1/4	6521 08 13WP2	19	23	0.004
	R3/8	6521 08 17WP2	19	23	0.004
10	R1/4	6521 10 13WP2	19	25	0.004
	R3/8	6521 10 17WP2	19	25	0.005
	R1/2	6521 10 21WP2	22	25	0.008
12	R3/8	6521 12 17WP2	22	28	0.005
	R1/2	6521 12 21WP2	22	28	0.007

Thread without pre-coating.

6521 Stud Standpipe, Male NPTF Thread



Inch

Bio-based polymer

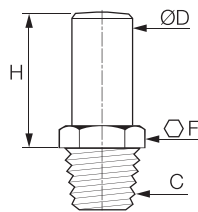

ØD	C		F	H	kg
1/4	NPT1/8	6521 56 11WP2	1/2	19	0.001
	NPT1/4	6521 56 14WP2	1/2	19	0.002
	NPT3/8	6521 56 18WP2	3/4	19.5	0.004
3/8	NPT1/4	6521 60 14WP2	3/4	25	0.004
	NPT3/8	6521 60 18WP2	3/4	25	0.004
1/2	NPT3/8	6521 62 18WP2	15/16	31	0.010
	NPT1/2	6521 62 22WP2	15/16	32.5	0.013

Thread without pre-coating.

6521 Stud Standpipe, Male BSPT Thread



Inch

Bio-based polymer

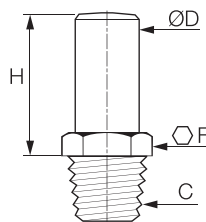

ØD	C		F	H	kg
1/4	R1/8	6521 56 10WP2	14	19	0.001
	R1/4	6521 56 13WP2	14	19	0.002
	R3/8	6521 56 17WP2	17	19	0.004
3/8	R1/4	6521 60 13WP2	19	25	0.004
	R3/8	6521 60 17WP2	19	25	0.004
1/2	R3/8	6521 62 17WP2	24	31.5	0.006
	R1/2	6521 62 21WP2	24	31.5	0.009

Thread without pre-coating. 5/16" (8mm) also available.

6300 LIQUIfit® Cartridge



Brass, EPDM

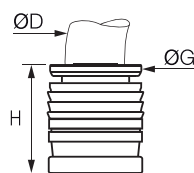

ØD		G	G1	H	L	kg
4	6300 04 00	8	11	10	554	0.002
6	6300 06 00	10	14.5	11.5	629	0.002
8	6300 08 00	13	15	15	794	0.003
10	6300 10 00	15.5	19.5	17	930	0.005
12	6300 12 00	18.5	21	19.5	1038	0.010

50 cartridges per Carstick®



6300 LIQUIfit® Cartridge



Inch

Brass, EPDM

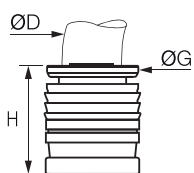

ØD		G	G1	H	L	kg
1/4	6300 56 00	10.5	14.5	12.5	600	0.002
3/8	6300 60 00	15.5	19	17	930	0.005
1/2	6300 62 00	22	25	23	1038	0.011

50 cartridges per Carstick®
5/32" (4 mm) and 5/16" (8 mm) also available.



Stud Fittings

6579 Fixed Elbow, Male BSPT Thread



Bio-based polymer, EPDM

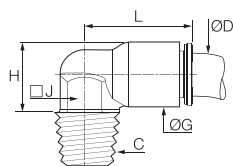

ØD	C		G	H	J	L	kg
6	R1/8	6579 06 10WP2	11	14	10	19	0.002
	R1/4	6579 06 13WP2	11	14	10	19	0.003
	R3/8	6579 06 17WP2	11	14	10	19	0.004

Thread without pre-coating.

6579 Fixed Elbow, Male NPTF Thread



Inch

Bio-based polymer, EPDM

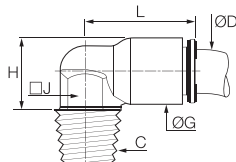

ØD	C		G	H	J	L	kg
1/4	NPT1/8	6579 56 11WP2	11	22	3/8	18	0.009
	NPT1/4	6579 56 14WP2	11	26	3/8	18	0.003
	NPT3/8	6579 56 18WP2	11	26.5	3/8	18	0.004
3/8	NPT1/4	6579 60 14WP2	16	32	1/2	26	0.006
	NPT3/8	6579 60 18WP2	16	32	1/2	26	0.006

Thread without pre-coating.

6579 Fixed Elbow, Male BSPT Thread



Inch

Bio-based polymer, EPDM

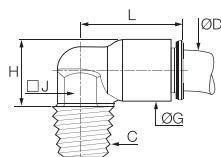

ØD	C		G	H	J	L	kg
1/4	R1/8	6579 56 10WP2	11	22	10	18	0.002
	R1/4	6579 56 13WP2	11	26	10	18	0.003
	R3/8	6579 56 17WP2	11	26	10	18	0.004
3/8	R1/4	6579 60 13WP2	16	31.5	13	26	0.006
	R3/8	6579 60 17WP2	16	32	13	26	0.006

Thread without pre-coating.

6509 Stud Elbow, Male BSPT Thread



Bio-based polymer, EPDM

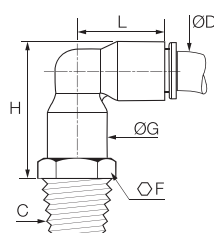

ØD	C		F	G	H	L	kg	
6	R1/8	6509 06 10WP2	13	10.5	28	24	0.037	
	R1/4	6509 06 13WP2	14	10.5	28	24	0.007	
	R3/8	6509 06 17WP2	17	10.5	28	24	0.008	
8	R1/8	6509 08 10WP2	19	13.5	34	29.5	0.010	
	R1/4	6509 08 13WP2	6509 08 13WP3	19	13.5	34	29.5	0.011
	R3/8	6509 08 17WP2	19	13.5	34	29.5	0.011	
10	R1/4	6509 10 13WP2	19	16	38	34.5	0.019	
	R3/8	6509 10 17WP2	19	16	38	34.5	0.020	
12	R1/2	6509 10 21WP2	22	16	38	34.5	0.023	
	R3/8	6509 12 17WP2	22	19	44	40	0.022	
	R1/2	6509 12 21WP2	22	19	44	40	0.024	

 WP3 = high volumes (number of parts per bag: 40, 50 or 100, depending on the diameters)
 Thread without pre-coating, the body swivels for positioning purposes.

Complementary LIQUIfit® Range Products

The other LIQUIfit® range products are presented in the corresponding chapters of this catalogue:

Technical Tubing and Hose

Advanced PE

P. 3-26



Function Fittings

Non-Return Valves

P. 4-44



Industrial Ball Valves

LIQUIfit® Ball Valves

P. 6-34



Stud Fittings

6509 Stud Elbow, Male NPTF Thread



Bio-based polymer, EPDM

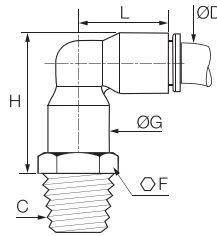

ØD	C		F	G	H	L	kg
1/4	NPT1/8	6509 56 11WP2	1/2	11	28	23.5	0.003
	NPT1/4	6509 56 14WP2	9/16	11	28	23.5	0.004
	NPT3/8	6509 56 18WP2	3/4	11	28.5	23.5	0.006
3/8	NPT1/4	6509 60 14WP2	3/4	16	38	34	0.010
	NPT3/8	6509 60 18WP2	3/4	16	38	34	0.011
1/2	NPT3/8	6509 62 18WP2	15/16	22	50.5	46.5	0.024
	NPT1/2	6509 62 22WP2	15/16	22	51.5	46.5	0.027

Thread without pre-coating, the body swivels for positioning purposes.

6509 Stud Elbow, Male BSPT Thread



Bio-based polymer, EPDM

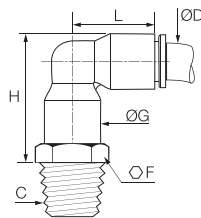

ØD	C		F	G	H	L	kg
1/4	R1/8	6509 56 10WP2	14	11	28	23.5	0.003
	R1/4	6509 56 13WP2	14	11	28	23.5	0.004
	R3/8	6509 56 17WP2	17	11	28	23.5	0.006
3/8	R1/4	6509 60 13WP2	19	16	38	34	0.010
	R3/8	6509 60 17WP2	19	16	38	34	0.011
1/2	R3/8	6509 62 17WP2	24	22	50.5	46.5	0.024
	R1/2	6509 62 21WP2	24	22	50.5	46.5	0.027

5/16" (8 mm) also available.

Thread without pre-coating, the body swivels for positioning purposes.

6508 Branch Tee, Male BSPT Thread



Bio-based polymer, EPDM

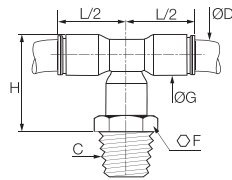

ØD	C		F	G	H	L/2	kg
6	R1/8	6508 06 10WP2	13	10.5	28	18	0.008
	R1/4	6508 06 13WP2	14	10.5	28	18	0.009
	R3/8	6508 06 17WP2	17	10.5	28	18	0.010
8	R1/8	6508 08 10WP2	19	13.5	34	23	0.012
	R1/4	6508 08 13WP2	19	13.5	34	23	0.013
	R3/8	6508 08 17WP2	19	13.5	34	23	0.013
10	R1/4	6508 10 13WP2	19	16	38	26.5	0.018
	R3/8	6508 10 17WP2	19	16	38	26.5	0.019
	R1/2	6508 10 21WP2	22	16	38	26.5	0.022
12	R3/8	6508 12 17WP2	22	19	44	31	0.024
	R1/2	6508 12 21WP2	22	19	44	31	0.026

Thread without pre-coating, the body swivels for positioning purposes.

6508 Branch Tee, Male NPTF Thread



Bio-based polymer, EPDM

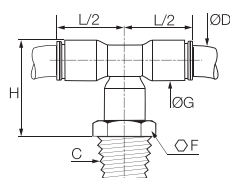

ØD	C		F	G	H	L/2	kg
1/4	NPT1/8	6508 56 11WP2	1/2	11	28	18	0.004
	NPT1/4	6508 56 14WP2	9/16	11	28	18	0.005
	NPT3/8	6508 56 18WP2	3/4	11	29	18	0.007
3/8	NPT1/4	6508 60 14WP2	3/4	16	38	26	0.013
	NPT3/8	6508 60 18WP2	3/4	16	38	26	0.013
1/2	NPT3/8	6508 62 18WP2	15/16	22	50	35.5	0.031
	NPT1/2	6508 62 22WP2	15/16	22	51	35.5	0.034

Thread without pre-coating, the body swivels for positioning purposes.

Stud Fittings

6508 Branch Tee, Male BSPT Thread



Bio-based polymer, EPDM

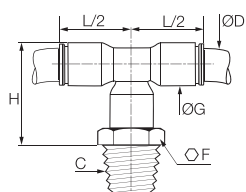

ØD	C		F	G	H	L/2	kg
R1/8	6508 56 10WP2		13	11	28	18	0.000
1/4	R1/4	6508 56 13WP2	14	11	28	18	0.000
	R3/8	6508 56 17WP2	17	11	28	18	0.000
3/8	R1/4	6508 60 13WP2	19	16	38	26	0.000
	R3/8	6508 60 17WP2	19	16	38	26	0.013
1/2	R3/8	6508 62 17WP2	24	22	50	35.5	0.000
	R1/2	6508 62 21WP2	24	22	50	35.5	0.000

5/16" (8 mm) also available.
Thread without pre-coating, the body swivels for positioning purposes.

6503 Run Tee, Male BSPT Thread



Bio-based polymer, EPDM

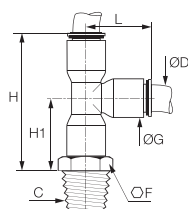

ØD	C		F	G	H	H1	L	kg
R1/8	6503 06 10WP2		13	10.5	40	22	18.5	0.008
6	R1/4	6503 06 13WP2	14	10.5	40	22	18.5	0.009
	R3/8	6503 06 17WP2	17	10.5	40	22	18.5	0.010
	R1/8	6503 08 10WP2	19	13.5	50	27	23	0.012
8	R1/4	6503 08 13WP2	19	13.5	50	27	23	0.013
	R3/8	6503 08 17WP2	19	13.5	50	27	23	0.013
	R1/4	6503 10 13WP2	19	16	56.5	30	26.5	0.018
10	R3/8	6503 10 17WP2	19	16	56.5	30	26.5	0.019
	R1/2	6503 10 21WP2	22	16	56.5	30	26.5	0.022
12	R3/8	6503 12 17WP2	22	19	65.5	34.5	31	0.024
	R1/2	6503 12 21WP2	22	19	65.5	34.5	31	0.026

Thread without pre-coating, the body swivels for positioning purposes.

6503 Run Tee, Male BSPT Thread



Bio-based polymer, EPDM

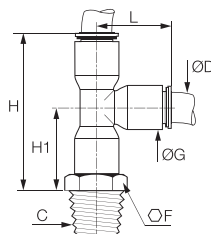

ØD	C		F	G	H	H1	L	kg
NPT1/8	6503 56 11WP2		1/2	11	40.5	22.5	18	0.004
1/4	NPT1/4	6503 56 14WP2	9/16	11	40.5	22.5	18	0.005
	NPT3/8	6503 56 18WP2	3/4	11	41.5	23	18	0.007
3/8	NPT1/4	6503 60 14WP2	3/4	16	56	30	26	0.013
	NPT3/8	6503 60 18WP2	3/4	16	56	30	26	0.013
1/2	NPT3/8	6503 62 18WP2	15/16	22	75	39.5	35.5	0.031
	NPT1/2	6503 62 22WP2	15/16	22	76	40.5	35.5	0.035

Thread without pre-coating, the body swivels for positioning purposes.

6503 Run Tee, Male BSPT Thread



Bio-based polymer, EPDM

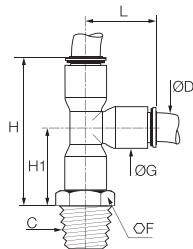

ØD	C		F	G	H	H1	L	kg
R1/8	6503 56 10WP2		14	11	41.5	22.5	18	0.004
1/4	R1/4	6503 56 13WP2	14	11	41.5	22.5	18	0.005
	R3/8	6503 56 17WP2	17	11	41.5	23	18	0.007
	R1/4	6503 60 13WP2	19	16	56	30	26	0.013
3/8	R3/8	6503 60 17WP2	19	16	56	30	26	0.013
	R3/8	6503 62 17WP2	24	22	75	39.5	35.5	0.032
1/2	R1/2	6503 62 21WP2	24	22	75	39.5	35.5	0.035

Thread without pre-coating, the body swivels for positioning purposes.

6355 Unequal Connector, Female BSPP Thread



Bio-based polymer

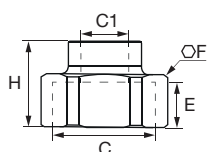

C	C1		E	F	H	kg
G3/4	G1/4	6355 13 27WP2	10	32	23.5	0.050

Tube-to-Tube Fittings

6306 Equal and Unequal Tube-to-Tube Connector



Bio-based polymer, EPDM

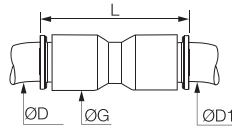

ØD	ØD1			G	L	kg
4	4	6306 04 00WP2		8.5	26.5	0.002
	6	6306 04 06WP2		10.5	29	0.002
	8	6306 04 08WP2		13.5	37	0.005
6	6	6306 06 00WP2	6306 06 00WP3	10.5	30	0.004
	8	6306 06 08WP2		13.5	37	0.005
	10	6306 06 10WP2		16	42	0.007
8	8	6306 08 00WP2	6306 08 00WP3	13.5	37	0.004
	10	6306 08 10WP2		16	42	0.007
	12	6306 08 12WP2		19	50	0.012
10	10	6306 10 00WP2	6306 10 00WP3	16	42	0.009
	12	6306 10 12WP2		19	50	0.013
12	12	6306 12 00WP2	6306 12 00WP3	19	50.5	0.009

WP3 = high volumes (number of parts per bag: 40, 50 or 100, depending on the diameters)

6306 Equal and Unequal Union Connector



Inch

Bio-based polymer, EPDM

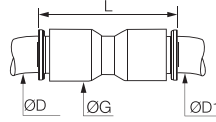

ØD	ØD1			G	L	kg
5/16	3/8	6306 08 60WP2		16	42	0.008
	1/2	6306 08 62WP2		22	55	0.018
1/4	1/4	6306 56 00WP2	6306 56 00WP3	11	30	0.004
	5/16	6306 56 08WP2	6306 56 08WP3	13.5	37	0.007
	3/8	6306 56 60WP2		16	41	0.007
3/8	3/8	6306 60 00WP2	6306 60 00WP3	16	42	0.006
	1/2	6306 60 62WP2		22	56	0.020
1/2	1/2	6306 62 00WP2		22	57	0.016

WP3 = high volumes (number of parts per bag: 40, 50 or 100, depending on the diameters)

6302 Equal and Unequal Elbow



Bio-based polymer, EPDM

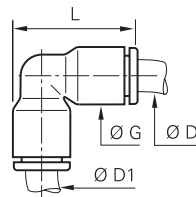

ØD	ØD1			G	L	kg
4	4	6302 04 00WP2		8.5	19	0.002
	6	6302 04 06WP2		10.5	24	0.004
6	6	6302 06 00WP2	6302 06 00WP3	10.5	24	0.004
	8	6302 06 08WP2		13.5	29.5	0.006
8	8	6302 08 00WP2	6302 08 00WP3	13.5	29	0.004
	10	6302 08 10WP2		16	34.5	0.008
10	10	6302 10 00WP2	6302 10 00WP3	16	34.5	0.005
	12	6302 10 12WP2		19	40.5	0.013
12	12	6302 12 00WP2	6302 12 00WP3	19	40.5	0.010

WP3 = high volumes (number of parts per bag: 40, 50 or 100, depending on the diameters)

6302 Equal and Unequal Union Elbow



Inch

Bio-based polymer, EPDM

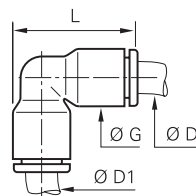

ØD	ØD1			G	L	kg
5/16	3/8	6302 08 60WP2		16	34	0.009
	1/4	6302 56 00WP2	6302 56 00WP3	11	24	0.005
1/4	5/16	6302 56 08WP2	6302 56 08WP3	13.5	29.5	0.006
	3/8	6302 56 60WP2		16	34	0.008
3/8	3/8	6302 60 00WP2	6302 60 00WP3	16	34	0.006
	1/2	6302 60 62WP2		22	46.5	0.011
1/2	1/2	6302 62 00WP2		22	46.5	0.017

WP3 = high volumes (number of parts per bag: 40, 50 or 100, depending on the diameters)

Tube-to-Tube Fittings

6304 Equal Tee



Bio-based polymer, EPDM

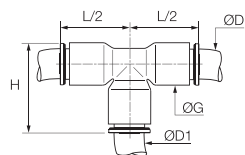

ØD	ØD1			G	H	L/2	kg	
4	4	6304 04 00WP2			8.5	20	15.5	0.004
6	6	6304 06 00WP2	6304 06 00WP3		10.5	23	18	0.006
8	8	6304 08 00WP2	6304 08 00WP3		13.5	29	22.5	0.006
10	10	6304 10 00WP2	6304 10 00WP3		16	34.5	26.5	0.009
12	12	6304 12 00WP2	6304 12 00WP3		19	40	31	0.014

WP3 = high volumes (number of parts per bag: 40, 50 or 100, depending on the diameters)

6304 Equal and Unequal Tee



Inch

Bio-based polymer, EPDM

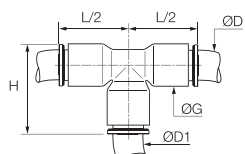

ØD	ØD1			G	H	L/2	kg	
1/4	1/4	6304 56 00WP2	6304 56 00WP3		11	24	18	0.002
3/8	3/8	6304 60 00WP2	6304 60 00WP3		16	34	26	0.009
	1/4	6304 60 56WP2			16	34	26	0.011
1/2	1/2	6304 62 00WP2			22	47	36	0.027
	3/8	6304 62 60WP2			22	47	36	0.009

WP3 = high volumes (number of parts per bag: 40, 50 or 100, depending on the diameters)
5/32" (4 mm) and 5/16" (8 mm) also available

6340 Equal Single Y Piece



Bio-based polymer, EPDM

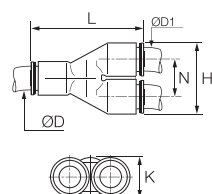

ØD	ØD1			H	K	L	N	kg
4	4	6340 04 00WP2		17.5	8.5	30	9	0.004
6	6	6340 06 00WP2	6340 06 00WP3	21.5	10.5	36.5	11	0.008
8	8	6340 08 00WP2		28	13.5	44.5	14.5	0.007
10	10	6340 10 00WP2		33	16	53	17	0.010
12	12	6340 12 00WP2		39	19	60.5	20	0.025

WP3 = high volumes (number of parts per bag: 40, 50 or 100, depending on the diameters)

6340 Equal Single Y Piece



Inch

Bio-based polymer, EPDM

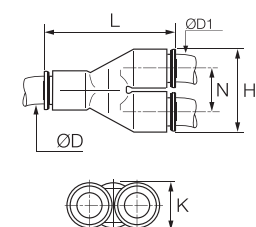

ØD	ØD1			H	K	L	N	kg
1/4	1/4	6340 56 00WP2	6340 56 00WP3	22	11	36	11.5	0.010
3/8	3/8	6340 60 00WP2		33	16	53	17	0.011
1/2	1/2	6340 62 00WP2		45	22	67	23	0.028

WP3 = high volumes (number of parts per bag: 40, 50 or 100, depending on the diameters).
5/32" (4 mm) and 5/16" (8 mm) also available

Tube-to-Tube and Bulkhead Connectors

6307 Equal Cross



Bio-based polymer, EPDM

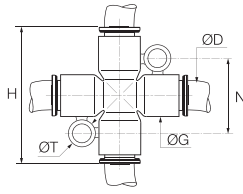

ØD		G	H	N	ØT	kg
6	6307 06 00WP2	11	36	20	4.2	0.005
8	6307 08 00WP2	13.5	45	22.5	4.2	0.020

6307 Equal Cross



Inch

Bio-based polymer, EPDM

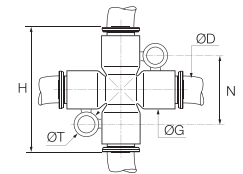

ØD		G	H	L	ØT	kg
1/4	6307 56 00WP2	11	36	20	4.2	0.010

5/16" (8 mm) also available

6316 Equal Bulkhead Union



Bio-based polymer, EPDM

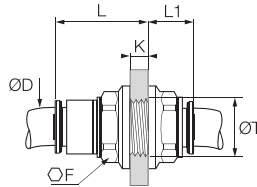

ØD			F	K max	L	L1	ØT min	kg
4	6316 04 00WP2		13	5.5	15.5	10.5	10.5	0.018
6	6316 06 00WP2	6316 06 00WP3	15	8.5	20	10	12.5	0.004
8	6316 08 00WP2	6316 08 00WP3	18	14.5	27	10.5	15.5	0.007
10	6316 10 00WP2	6316 10 00WP3	22	14.5	30	13	18.5	0.012
12	6316 12 00WP2	6316 12 00WP3	26	18.5	35	15.5	22.5	0.020

WP3 = high volumes (number of parts per bag: 40, 50 or 100, depending on the diameters)

6316 Equal Bulkhead Union



Inch

Bio-based polymer, EPDM

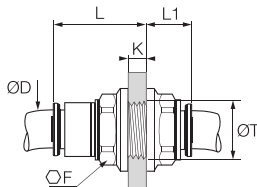

ØD			F	K max	L	L1	ØT min	kg
1/4	6316 56 00WP2	6316 56 00WP3	15	8.5	20	10	12.5	0.004
3/8	6316 60 00WP2		22	14.5	29.5	12.5	18.5	0.012
1/2	6316 62 00WP2		29	20.5	40.5	17	25.5	0.030

WP3 = high volumes (number of parts per bag: 40, 50 or 100, depending on the diameters)
5/32" (4 mm) and 5/16" (8 mm) also available

Plug-In Fittings and Accessories

6382 Equal and Unequal Plug-In Elbow



Bio-based polymer, EPDM

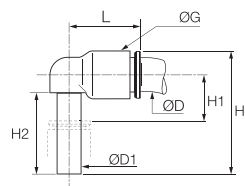

ØD	ØD1			G	H	H1	H2	L	kg
4	4	6382 04 00WP2		8.5	23	6	15.5	15	0.003
	6	6382 04 06WP2		10.5	26.5	7	17	16.5	0.002
6	6	6382 06 00WP2	6382 06 00WP3	10.5	26.5	7	17	17	0.003
	4	6382 06 04WP2		10.5	25	7	15.5	17	0.001
	8	6382 06 08WP2		13.5	33.5	8	21.5	22.5	0.004
	8	6382 08 00WP2	6382 08 00WP3	13.5	33.5	8	21.5	22.5	0.004
8	10	6382 08 10WP2		16	39	9.5	24.5	26	0.007
	10	6382 10 00WP2	6382 10 00WP3	16	39	9.5	24.5	26.5	0.004
10	12	6382 10 12WP2		19	44.5	10	27	30	0.011
	12	6382 12 00WP2	6382 12 00WP3	19	44.5	10	27	31	0.012

WP3 = high volumes (number of parts per bag: 40, 50 or 100, depending on the diameters).

6382 Equal and Unequal Plug-In Elbow



Inch

Bio-based polymer, EPDM

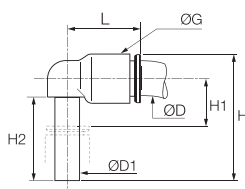

ØD	ØD1			G	H	H1	H2	L	kg
5/16	3/8	6382 08 60WP2		16	39	10	24.5	26	0.009
1/4	1/4	6382 56 00WP2	6382 56 00WP3	11	30.5	11	18	18	0.000
	3/8	6382 56 60WP2		16	39	9	24.5	25.5	0.006
3/8	3/8	6382 60 00WP2	6382 60 00WP3	16	39	9	24.5	26.5	0.005
1/2	1/2	6382 62 00WP2		22	49	13	28.5	36	0.000

 WP3 = high volumes (number of parts per bag: 40, 50 or 100, depending on the diameters)
 Equal plug-in elbow: 5/32" (4 mm) and 5/16" (8 mm) also available

6380 Plug-In 45° Equal Elbow



Bio-based polymer, EPDM

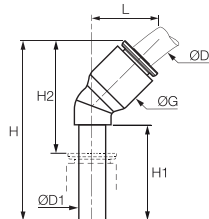

ØD	ØD1			G	H	H1	H2	L	kg
4	4	6380 04 00WP2		8.5	33.5	19	21	13	0.001
6	6	6380 06 00WP2		11	39	21	25	14.5	0.002
8	8	6380 08 00WP2		13.5	44	21.5	25.5	19.5	0.006
10	10	6380 10 00WP2		16	53	27	32.5	23	0.004
12	12	6380 12 00WP2		19	58	27	34	26	0.012

6383 Plug-In Equal Run Tee



Bio-based polymer, EPDM

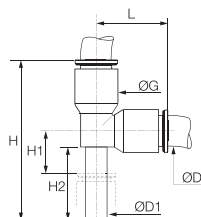

ØD	ØD1			G	H	H1	H2	L	kg
4	4	6383 04 00WP2		8.5	33	6	15.5	15	0.002
6	6	6383 06 00WP2		10.5	38.5	7	17	18	0.002
8	8	6383 08 00WP2	6383 08 00WP3	13.5	49	8	21.5	23	0.005
10	10	6383 10 00WP2		16	57	10.5	25.5	26.5	0.012
12	12	6383 12 00WP2		19	65	36.5	27	31	0.016

WP3 = high volumes (number of parts per bag: 40, 50 or 100, depending on the diameters)

6388 Plug-In Equal Branch Tee



Bio-based polymer, EPDM

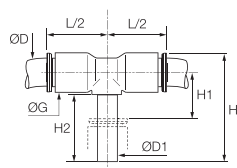

ØD	ØD1			G	H	H1	H2	L/2	kg
4	4	6388 04 00WP2		8.5	25	6	15.5	15	0.005
6	6	6388 06 00WP2		10.5	28.5	7	17	16	0.006
8	8	6388 08 00WP2		13.5	33.5	8	21.5	23	0.005
10	10	6388 10 00WP2		16	41	9.5	24.5	26.5	0.007
12	12	6388 12 00WP2		19	46.5	10	27	31	0.016

Plug-In Fittings and Accessories

6388 Plug-In Branch Tee



Bio-based polymer, EPDM

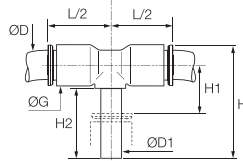

ØD	ØD1			G	H	H1	H2	L/2	kg
1/4	1/4			11	30.5	11	20	18	0.002
3/8	3/8			16	42	12	25	25	0.008
1/2	1/2			22	51	13	29	32	0.020

5/32" (4 mm) and 5/16" (8 mm) also available

6366 Plug-In Reducer



Bio-based polymer, EPDM

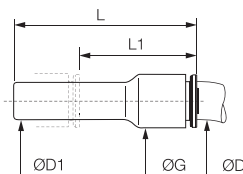

ØD	ØD1			G	L	L1	kg
4	6			8.5	38	23.5	0.004
	8			8.5	38	19	0.004
6	8			10.5	38	20	0.004
	10			10.5	39	17.5	0.002
8	10			13.5	48.5	28.5	0.009
	12			13.5	48.5	24.5	0.004
10	12			16	52	33.5	0.005
	14			16	53	33.5	0.005
12	14			19	55.5	33.5	0.023

WP3 = high volumes (number of parts per bag: 40, 50 or 100, depending on the diameters)

6366 Plug-In Reducer



Bio-based polymer, EPDM

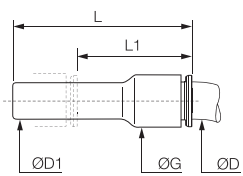

ØD	ØD1			G	L	L1	kg
1/4	5/16			11	41	22.5	0.015
	3/8			11	41	20.5	0.002
5/16	3/8			13.5	48.5	29	0.003
	1/2			16	48.5	22	0.007
3/8	1/2			16	51	30	0.011

5/32" (4 mm) and 5/16" (8 mm) also available

6368 Plug-In Increaser



Bio-based polymer, EPDM

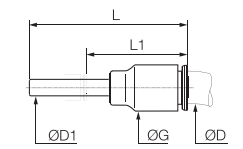

ØD	ØD1			G	L	L1	kg
3/8	5/16			16	44	25.5	0.004

6326 Blanking Plug



Bio-based polymer

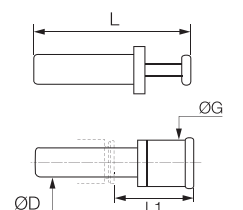

ØD				G	L	L1	kg
4				6	30	15.5	0.001
6				8	33	16.5	0.001
8				10	35	17.5	0.002
10				12	42	21	0.003
12				14	45	22	0.004

WP3 = high volumes (number of parts per bag: 40, 50 or 100, depending on the diameters)

Plug-In Fittings and Accessories

6326 Blanking Plug



Bio-based polymer

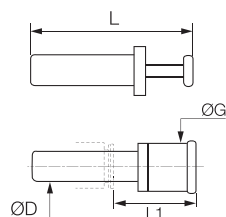

ØD			G	L	L1	kg
1/4	6326 56 00WP2	6326 56 00WP3	8	36.5	22	0.001
3/8	6326 60 00WP2		11.6	42.5	22	0.002
1/2	6326 62 00WP2		14.7	48.5	21.5	0.004

WP3 = high volumes (number of parts per bag: 40, 50 or 100, depending on the diameters)
5/32" (4 mm) and 5/16" (8 mm) also available

6322 Plug-In Barb Connector



Bio-based polymer

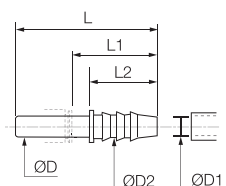

ØD	ØD1	ØD2		L	L1	L2	kg
6	4	7	6322 06 04WP2	39	25	17	0.004
8	6	8.5	6322 08 06WP2	43	25	17	0.005
10	7	8	6322 10 07WP2	50	29.5	22	0.006
12	12.5	15.5	6322 12 62WP2	56	32	27.5	0.004

6322 Plug-In Barb Connector



Bio-based polymer

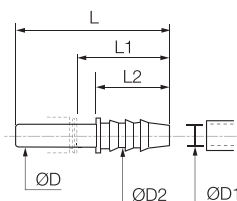

ØD	ØD1	ØD2		L	L1	L2	kg
1/4	0.28	0.32	6322 56 56WP2	39	24.5	17	0.001
	0.33	0.38	6322 60 08WP2	50	29.5	22	0.001
3/8	0.28	0.32	6322 60 56WP2	45	24.5	17	0.008
	0.40	0.45	6322 60 60WP2	50	29	22	0.002
1/2	0.40	0.45	6322 62 60WP2	58	37.5	30	0.005

6351 End Cap



Bio-based polymer, EPDM

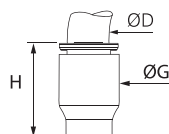

ØD		G	H	kg
4	6351 04 00WP2	8.5	15	0.001
6	6351 06 00WP2	10.5	17	0.002
8	6351 08 00WP2	13.5	21.5	0.003
10	6351 10 00WP2	16	22	0.003
12	6351 12 00WP2	19	27.5	0.006

6351 End Cap



Bio-based polymer, EPDM

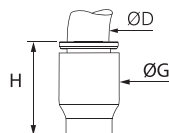

ØD		G	H	kg
1/4	6351 56 00WP2	11	16	0.001
3/8	6351 60 00WP2	16	22.5	0.003

5/32" (4 mm) and 5/16" (8 mm) also available

Accessories

3130 Tamper-Proof Safety Clip

Technical polymer

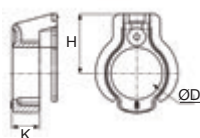

ØD							H	K	kg
4	3130 04 01	3130 04 02	3130 04 03	3130 04 04	3130 04 05	3130 04 10	6.5	3	0.001
6	3130 06 01	3130 06 02	3130 06 03	3130 06 04	3130 06 05	3130 06 10	8	3	0.001
8	3130 08 01	3130 08 02	3130 08 03	3130 08 04	3130 08 05	3130 08 10	9.5	4.3	0.001
10	3130 10 01	3130 10 02	3130 10 03	3130 10 04	3130 10 05	3130 10 10	10.8	4.2	0.001
12	3130 12 01	3130 12 02	3130 12 03	3130 12 04	3130 12 05	3130 12 10	12.5	5.1	0.004

3130 Tamper-Proof Safety Clip

Inch

Technical polymer

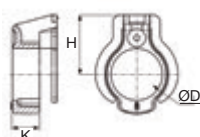

ØD							H	K	kg
1/4	3130 56 01	3130 56 02	3130 56 03	3130 56 04	3130 56 05	3130 56 10	8	3	0.001
3/8	3130 60 01	3130 60 02	3130 60 03	3130 60 04	3130 60 05	3130 60 10	11	4	0.001
1/2	3130 62 01	3130 62 02	3130 62 03	3130 62 04	3130 62 05	3130 62 10	14	6	0.004

5/32" (4 mm) and 5/16" (8 mm) also available

3110 Coloured Release Button Covers

Technical polymer



ØD						kg
4	3110 04 00	3110 04 02	3110 04 03	3110 04 04	3110 04 05	0.006
6	3110 06 00	3110 06 02	3110 06 03	3110 06 04	3110 06 05	0.001
8	3110 08 00	3110 08 02	3110 08 03	3110 08 04	3110 08 05	0.001
10	3110 10 00	3110 10 02	3110 10 03	3110 10 04	3110 10 05	0.001
12	3110 12 00	3110 12 02	3110 12 03	3110 12 04	3110 12 05	0.001

3110 Coloured Release Button Covers

Inch

Technical polymer



ØD						kg
1/4	3110 56 00	3110 56 02	3110 56 03	3110 56 04	3110 56 05	0.002
3/8	3110 60 00	3110 60 02	3110 60 03	3110 60 04	3110 60 05	0.001
1/2	3110 62 00	3110 62 02	3110 62 03	3110 62 04	3110 62 05	0.001

5/32" (4 mm) and 5/16" (8 mm) also available

0605 Fluoropolymer Tape

FKM



0605 12 12

kg

0.012

Can be used for temperatures from - 250°C to +260°C.

Chemically inert and resistant to gases, acids, solvents, hydrocarbons, oils, alkalines, steam etc.

Non-toxic, waterproof, self-lubricating.

In accordance with CFR21.

Can be used on all materials.

Used to facilitate the preparation of leak-free threaded joints.

Supplied on a reel, length = 12 m, width = 12.7 mm, thickness 0.08 mm.



LIQUIFIT®

Push-In Fittings

LIQUIfit+ Push-In Fittings

For the transfer of sensitive fluids, the LIQUIfit+ range **reduces the growth of bacteria** in your circuits **for 100% cleanliness after cleaning**, and can be **directly** connected to stainless steel tubing, without grooving.

Product Advantages

Zero Retention for 100% Cleanliness

- Up to 10 times less microbial growth within the fitting
- Elimination of 99.9% of bacteria during cleaning operations
- No degradation of the beverage taste
- Preservation of the integrity of sensitive or industrial fluids
- Extension of the fitting's life due to the absence of bacteria after cleaning

Quality & Reliability

- 100% leak-tested in production
- Date coding to guarantee quality and traceability
- Quality approved for contact with food
- Excellent chemical resistance (chlorine, cleaning agents, UV...)
- Excellent long-term mechanical resistance
- Safety clip to avoid any untimely disconnection

Innovative Technology

- Patented push-in connection, unique on stainless steel tubing for diameters 5/16" and 3/8" (without preparation) and on polymer tubing
- Extremely compact
- 100% bio-based material
- Patented sealing technology (FR29461418)
- No tube movement after connection



Applications

- Food Process
- Medical
- Beverage Dispensers
- Pharmaceutical
- Chemical
- Brewing

Technical Characteristics

Compatible Fluids	Beer, water, beverages, industrial fluids
Working Pressure	Vacuum to 16 bar
Working Temperature	-10°C to +95°C (see LIQUIfit® chart p. 1-47)

Reliable performance is dependent upon the type of fluid conveyed, component materials and tubing being used. The use is guaranteed with a vacuum of 755 mm Hg (99% vacuum).

Component Materials

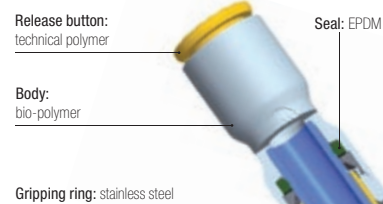

Silicone-free

Cleaning Efficiency

Comparison of the contamination by micro-organisms before and after cleaning operations (cfu/surface)*

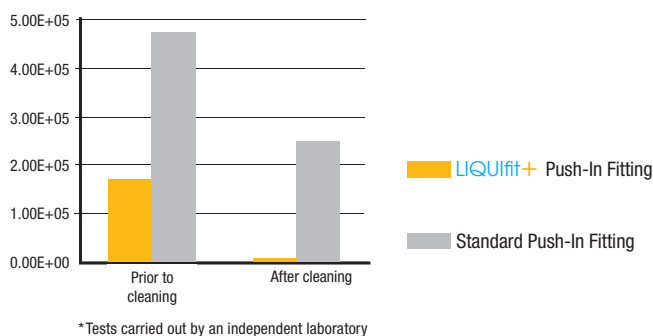

Regulations

DI: 2002/95/EC (RoHS), 2011/65/EC
 RG: 1935/2004/EC
 RG: 1907/2006 (REACH)

FDA: 21 CFR
 NSF51
 NSF/ANSI 61 - C HOT
 WRAS

Performance

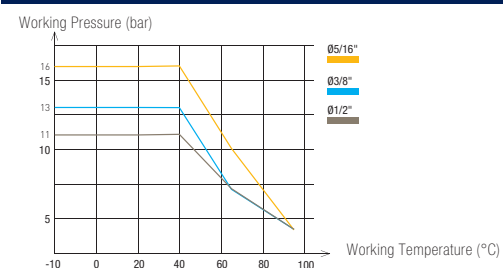

6333 Stud Fitting, Female BSPP Thread



Inch

Bio-based polymer, EPDM

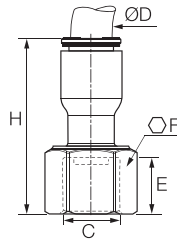

ØD	C		E	F	H	kg
3/8	G1/2	6333 60 21WP3	14	11	30	0.010
	G5/8	6333 60 23WP3	14	13	36	0.016

WP3 suffix = high volume (number of parts per bag: 40, 50 or 100 depending on the diameters)

6336 Equal and Unequal Tube-To-Tube Connector



Inch

Bio-based polymer, EPDM

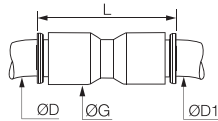

ØD	ØD1		G	L	kg
5/16	5/16	6336 08 00WP3	13.5	37	0.004
	3/8	6336 08 60WP3	16	42	0.008
	1/2	6336 08 62WP3	22	55	0.016
3/8	3/8	6336 60 00WP3	16	42	0.006
	1/2	6336 60 62WP3	22	56	0.020
1/2	1/2	6336 62 00WP3	22	57	0.016

WP3 = high volume (number of parts per bag: 40, 50 or 100 depending on the diameters)

6332 Equal and Unequal Elbow



Inch

Bio-based polymer, EPDM

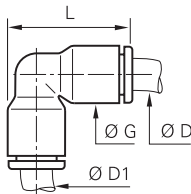

ØD	ØD1		G	L	kg
5/16	5/16	6332 08 00WP3	13.5	29	0.004
	3/8	6332 08 60WP3	16	34	0.009
3/8	3/8	6332 60 00WP3	16	34	0.006
	1/2	6332 60 62WP3	22	46.5	0.011
1/2	1/2	6332 62 00WP3	22	46.5	0.017

WP3 = high volume (number of parts per bag: 40, 50 or 100 depending on the diameters)

6331 Equal Plug-In Elbow



Inch

Bio-based polymer, EPDM

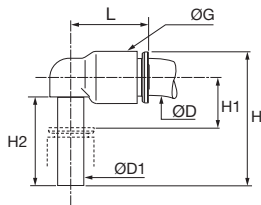

ØD	ØD1		G	H	H1	H2	L	kg
5/16	5/16	6331 08 00WP3	13.5	33.5	8	21.5	22.5	0.004
3/8	3/8	6331 60 00WP3	16	39	9	24.5	26.5	0.005

WP3 = high volume (number of parts per bag: 40, 50 or 100 depending on the diameters)

Use with Stainless Steel Tubing

- Valid exclusively for diameters 5/16" and 3/8".
- These fittings are approved for use with 304 and 316L stainless steel tubing, 160 Hv, with tolerances on the external diameter +0.05/-0.10 mm.
- Carefully deburr the stainless steel tube end.
- For easy disconnection, press firmly on the release button.
- After 5 connections/disconnections, we recommend that you change the fitting.



LIQUIfit® Push-In Fittings with Metal Adaptors

The LIQUIfit® range now benefits from a range extension of **metal adaptors** designed for **liquid transfer applications**. These fittings ensure **reliable** and **compact** connections combined with **excellent robustness**.

Product Advantages

Innovative Technology & Concept

- Ergonomic and aesthetic design
- Compact product for water applications
- Easy-to-clean external surfaces
- Full flow
- Use with a pre-prepared metallic tubing
- Gripping system preventing any pumping effect

Optimal Performance

- Patented sealing technology
- 100% leak-tested in production
- Date coding to guarantee quality and traceability
- Wide range of shapes and numerous configurations
- Excellent robustness for a long lifespan

High Performance Material

- Bio-sourced polymer body meeting the most severe food process regulations
- Compatibility with beverages (stainless steel version)
- Unsurpassed chemical and mechanical resistance, even at high temperatures
- Free of bisphenol A and phthalates, conforming with regulations



Industrial Fluids
Beverage Process
Inert Gases
Cooling Systems
Food Process

Applications

Technical Characteristics

Compatible Fluids	Water, beverages, industrial fluids: stainless steel threads Industrial fluids: FDA chemical nickel-plated brass threads					
Working Pressure	Vacuum to 16 bar					
Working Temperature	-10°C to +95°C (see LIQUIfit® chart p. 1-47)					
Tightening Torques (BSPP)	Thread	M5 X0.8	G1/8	G1/4	G3/8	G1/2
	daN.m	0.16	0.8	1.2	3	3.5

Reliable performance is dependent upon the type of fluid conveyed, component materials and tubing being used.
Use is guaranteed with a vacuum of 755 mm Hg (99% vacuum).

Performance

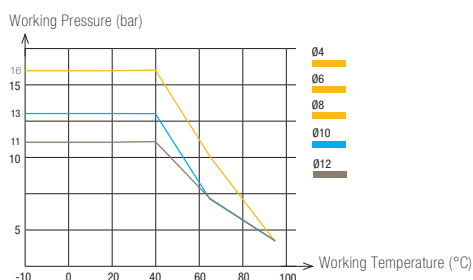

Component Materials

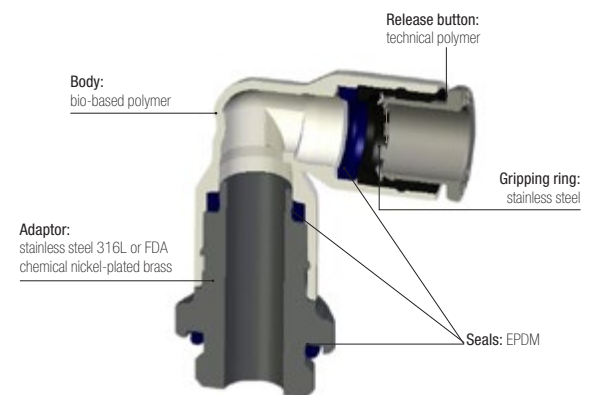

Silicone-free

Regulations

- DI: 2002/95/EC (RoHS), 2011/65/EC
- RG: 1935/2004/EC
- RG: 1907/2006 (REACH)
- FDA: 21 CFR
- NSF 51 (pending)
- NSF/ANSI 61 (pending, for stainless steel version only)

Stud Fittings with Stainless Steel Adaptor

6911 Stud Fitting, Male BSPP and Metric Thread



Stainless steel 316L, EPDM

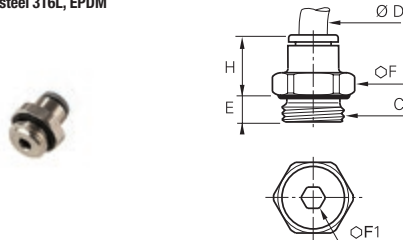

ØD	C		E	F	F1	H	kg
4	M5x0.8	6911 04 19	3	10	2.5	14	0.006
	G1/8	6911 04 10	4.5	13	3	11.5	0.007
	G1/4	6911 04 13	5.5	16	3	10.5	0.011
6	M5x0.8	6911 06 19	3	10	2.5	16	0.005
	G1/8	6911 06 10	4.5	13	4	13	0.007
	G1/4	6911 06 13	5.5	16	4	12.5	0.011
8	G1/8	6911 08 10	4.5	13	5	20.5	0.011
	G1/4	6911 08 13	5.5	16	6	19.5	0.016
	G3/8	6911 08 17	5.5	21	6	18	0.022
10	G1/4	6911 10 13	5.5	16	7	23	0.018
	G3/8	6911 10 17	5.5	21	8	19.5	0.021
	G1/2	6911 10 21	7	24	8	18	0.033
12	G3/8	6911 12 17	5.5	21	9	27	0.029
	G1/2	6911 12 21	7	24	10	22.5	0.035

6975 Stud Fitting, Male BSPT Thread



Stainless steel 316L, EPDM

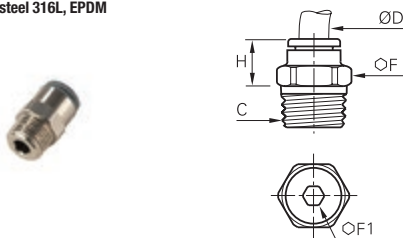

ØD	C		F	F1	H	kg
4	R1/8	6975 04 10	10	3	9.5	0.005
	R1/4	6975 04 13	14	3	6.5	0.012
6	R1/8	6975 06 10	10	4	11.5	0.005
	R1/4	6975 06 13	14	4	8.5	0.011
8	R1/8	6975 08 10	13	5	20	0.011
	R1/4	6975 08 13	14	6	17	0.014
10	R3/8	6975 08 17	17	6	13	0.021
	R1/4	6975 10 13	16	7	20	0.017
	R3/8	6975 10 17	17	8	16.5	0.019
	R1/2	6975 10 21	21	8	14	0.037
12	R3/8	6975 12 17	19	9	24	0.028
	R1/2	6975 12 21	21	10	19.5	0.036

6959 Stud Elbow, Male BSPP and Metric Thread



Bio-based polymer, stainless steel 316L, EPDM

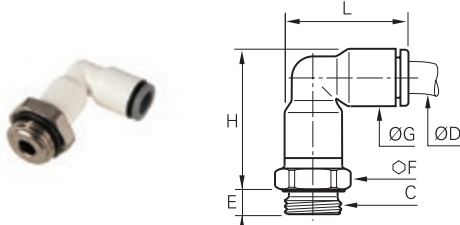

ØD	C		E	F	G	H	L	kg
4	M5x0.8	6959 04 19	3.5	10	8.5	23	19	0.009
	G1/8	6959 04 10	4.5	13	8.5	22.5	19	0.009
	G1/4	6959 04 13	5.5	16	8.5	22.5	19	0.014
6	M5x0.8	6959 06 19	3.5	10	10.5	26.5	22.5	0.008
	G1/8	6959 06 10	4.5	13	10.5	26.5	22.5	0.011
	G1/4	6959 06 13	5.5	16	10.5	26.5	22.5	0.016
8	G1/8	6959 08 10	4.5	13	13.5	35	29.5	0.018
	G1/4	6959 08 13	5.5	16	13.5	33	29.5	0.020
	G3/8	6959 08 17	5.5	21	13.5	33	29.5	0.028
10	G1/4	6959 10 13	5.5	16	16	40.5	34	0.029
	G3/8	6959 10 17	5.5	21	16	39	34	0.037
	G1/2	6959 10 21	7	24	16	39	34	0.042
12	G3/8	6959 12 17	5.5	21	19	42	40	0.040
	G1/2	6959 12 21	7	24	19	42	40	0.049

The body swivels for positioning purposes.

Stud Fittings with Stainless Steel Adaptor

6979 Stud Elbow, Male BSPT Thread



Bio-based polymer, stainless steel 316L, EPDM

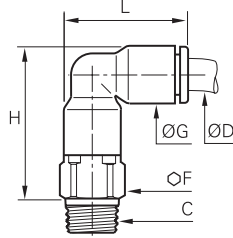

ØD	C		F	G	H	L	kg
4	R1/8	6979 04 10	10	8.5	23	19	0.008
	R1/4	6979 04 13	14	8.5	23.5	19	0.018
6	R1/8	6979 06 10	10	10.5	27	22.5	0.010
	R1/4	6979 06 13	14	10.5	27.5	22.5	0.020
8	R1/8	6979 08 10	13	13.5	33.5	29.5	0.018
	R1/4	6979 08 13	14	13.5	32.5	29.5	0.022
	R3/8	6979 08 17	17	13.5	33	29.5	0.032
10	R1/4	6979 10 13	15	16	39.5	34	0.031
	R3/8	6979 10 17	17	16	39.5	34	0.041
12	R1/2	6979 12 21	21	16	39.5	34	0.060
	R3/8	6979 12 17	19	19	45.5	40.5	0.051
	R1/2	6979 12 21	21	19	45.5	40.5	0.065

The body swivels for positioning purposes.

6958 Stud Branch Tee, Male BSPP and Metric Thread



Bio-based polymer, stainless steel 316L, EPDM

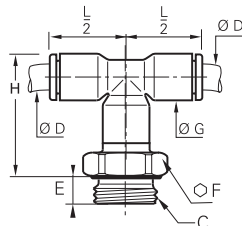

ØD	C		E	F	G	H	L/2	kg
4	M5x0.8	6958 04 19	3.5	10	8.5	24	14	0.006
	G1/8	6958 04 10	5	13	8.5	22	14	0.009
	G1/4	6958 04 13	5.5	16	8.5	22	14	0.014
6	M5x0.8	6958 06 19	3.5	10	10.5	30	16	0.009
	G1/8	6958 06 10	5	13	10.5	28.5	16	0.011
	G1/4	6958 06 13	5.5	16	10.5	28.5	16	0.016
8	G1/8	6958 08 10	4.5	13	13.5	38	23	0.019
	G1/4	6958 08 13	5.5	16	13.5	36	23	0.022
	G3/8	6958 08 17	5.5	21	13.5	36	23	0.030
10	G1/4	6958 10 13	5.5	16	16	43	26.5	0.032
	G3/8	6958 10 17	5.5	21	16	43	26.5	0.055
	G1/2	6958 10 21	7.5	24	16	43	26.5	0.051
12	G3/8	6958 12 17	5.5	21	19	45.5	31	0.042
	G1/2	6958 12 21	7	24	19	45.5	31	0.049

These products are available upon request, with minimum order quantity of 100 pieces.
The body swivels for positioning purposes.

6978 Stud Branch Tee, Male BSPT Thread



Bio-based polymer, stainless steel 316L, EPDM

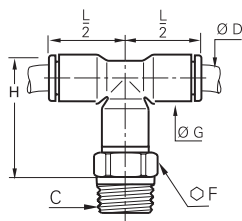

ØD	C		F	G	H	L/2	kg
4	R1/8	6978 04 10	10	8.5	17	14	0.009
	R1/4	6978 04 13	14	8.5	17	14	0.020
6	R1/8	6978 06 10	10	10.5	23	16	0.011
	R1/4	6978 06 13	14	10.5	23	16	0.011
8	R1/8	6978 08 10	13	13.5	30	23	0.020
	R1/4	6978 08 13	14	13.5	30	23	0.025
	R3/8	6978 08 17	17	13.5	30	23	0.036
10	R1/4	6978 10 13	15	16	34.5	26.5	0.033
	R3/8	6978 10 17	17	16	34.5	26.5	0.043
12	R1/2	6978 12 21	21	16	34.5	26.5	0.065
	R3/8	6978 12 17	19	19	40.5	31	0.053
	R1/2	6978 12 21	21	19	40.5	31	0.061

These products are available upon request, with minimum order quantity of 100 pieces.
The body swivels for positioning purposes.

Stud Fittings with Stainless Steel Adaptor

6953 Stud Run Tee, Male BSPP and Metric Thread



Bio-based polymer, stainless steel 316L, EPDM

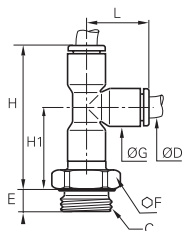

ØD	C		E	F	G	H	H1	L	kg
4	M5x0.8	6953 04 19	3.5	10	8.5	32	19	14.5	0.006
	G1/8	6953 04 10	5	13	8.5	30	18	14.5	0.009
	G1/4	6953 04 13	5.5	16	8.5	30	18	14.5	0.014
6	M5x0.8	6953 06 19	3.5	10	10.5	39	23	17.5	0.009
	G1/8	6953 06 10	5	13	10.5	38	22	17.5	0.011
	G1/4	6953 06 13	5.5	16	10.5	38	22	17.5	0.016
8	G1/8	6953 08 10	4.5	13	13.5	54	31	23	0.019
	G1/4	6953 08 13	5.5	16	13.5	52	29	23	0.022
	G3/8	6953 08 17	5.5	21	13.5	52	29	23	0.030
10	G1/4	6953 10 13	5.5	16	16	61	35	26.5	0.032
	G3/8	6953 10 17	5.5	21	16	61	35	26.5	0.055
	G1/2	6953 10 21	7.5	24	16	61	35	26.5	0.051
12	G3/8	6953 12 17	5.5	21	19	67	36	31	0.042
	G1/2	6953 12 21	7	24	19	67	36	31	0.049

These products are available upon request, with minimum order quantity of 100 pieces.
The body swivels for positioning purposes.

6973 Stud Run Tee, Male BSPT Thread



Bio-based polymer, stainless steel 316L, EPDM

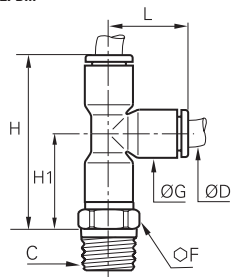

ØD	C		F	G	H	H1	L	kg
4	R1/8	6973 04 10	10	8.5	31	18	14.5	0.009
	R1/4	6973 04 13	14	8.5	31	19	14.5	0.020
6	R1/8	6973 06 10	10	10.5	38	22	17.5	0.011
	R1/4	6973 06 13	14	10.5	39	23	17.5	0.011
8	R1/8	6973 08 10	13	13.5	53	30	23	0.020
	R1/4	6973 08 13	14	13.5	52	29	23	0.025
10	R3/8	6973 08 17	17	13.5	52	29	23	0.036
	R1/4	6973 10 13	15	16	61	35	26.5	0.033
	R3/8	6973 10 17	17	16	61	35	26.5	0.043
12	R1/2	6973 10 21	21	16	61	35	26.5	0.065
	R3/8	6973 12 17	19	19	70	39	31	0.053
	R1/2	6973 12 21	21	19	70	39	31	0.061

These products are available upon request, with minimum order quantity of 100 pieces.
The body swivels for positioning purposes.

LIQUIFF®

Stud Fittings with FDA Chemical Nickel-Plated Brass Adaptor

6901 Stud Fitting, Male BSPP and Metric Thread



FDA chemical nickel-plated brass, EPDM

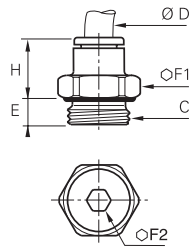

ØD	C		E	F	F1	H	kg
4	M5x0.8	6901 04 19	3	8	2.5	14	0.003
	G1/8	6901 04 10	5.5	13	3	11.5	0.007
	G1/4	6901 04 13	5.5	16	3	10.5	0.011
6	M5x0.8	6901 06 19	3	10	2.5	16	0.005
	G1/8	6901 06 10	4.5	13	4	13	0.007
	G1/4	6901 06 13	5.5	16	4	12.5	0.011
8	G1/8	6901 08 10	4.5	13	5	20.5	0.011
	G1/4	6901 08 13	5.5	16	6	19.5	0.016
	G3/8	6901 08 17	5.5	20	6	18	0.022
10	G1/4	6901 10 13	5.5	16	7	23	0.018
	G3/8	6901 10 17	5.5	20	8	19.5	0.021
	G1/2	6901 10 21	7	24	8	18	0.033
12	G3/8	6901 12 17	5.5	20	9	27	0.029
	G1/2	6901 12 21	7	24	10	22.5	0.035

6905 Stud Fitting, Male BSPT Thread



FDA chemical nickel-plated brass, EPDM

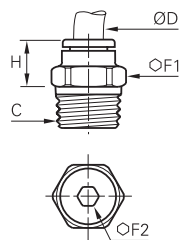

ØD	C		F	F1	H	kg
4	R1/8	6905 04 10	10	3	9.5	0.005
	R1/4	6905 04 13	14	3	6.5	0.012
6	R1/8	6905 06 10	10	4	11.5	0.005
	R1/4	6905 06 13	14	4	8.5	0.011
8	R1/8	6905 08 10	13	5	20	0.011
	R1/4	6905 08 13	14	6	17	0.014
	R3/8	6905 08 17	17	6	13	0.021
10	R1/4	6905 10 13	16	7	20	0.017
	R3/8	6905 10 17	17	8	16.5	0.019
	R1/2	6905 10 21	21	8	14	0.037
12	R3/8	6905 12 17	19	9	24	0.028
	R1/2	6905 12 21	21	10	19.5	0.036

6999 Stud Elbow, Male BSPP and Metric Thread



Bio-based polymer, FDA chemical nickel-plated brass, EPDM

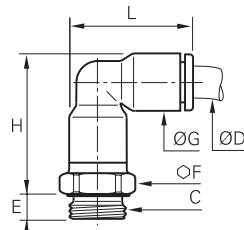

ØD	C		E	F	G	H	L	kg
4	M5x0.8	6999 04 19	3.5	8	8.5	23	19	0.005
	G1/8	6999 04 10	4.5	13	8.5	22.5	19	0.009
	G1/4	6999 04 13	5.5	16	8.5	22.5	19	0.014
6	M5x0.8	6999 06 19	3.5	10	10.5	26.5	22.5	0.008
	G1/8	6999 06 10	4.5	13	10.5	26.5	22.5	0.011
	G1/4	6999 06 13	5.5	16	10.5	26.5	22.5	0.016
8	G1/8	6999 08 10	4.5	13	13.5	35	29.5	0.018
	G1/4	6999 08 13	5.5	16	13.5	33	29.5	0.020
	G3/8	6999 08 17	5.5	20	13.5	33	29.5	0.028
10	G1/4	6999 10 13	5.5	16	16	40.5	34	0.029
	G3/8	6999 10 17	5.5	20	16	39	34	0.037
	G1/2	6999 10 21	7	24	16	39	34	0.042
12	G3/8	6999 12 17	5.5	20	19	42	40	0.040
	G1/2	6999 12 21	7	24	19	42	40	0.049

The body swivels for positioning purposes.

Stud Fittings with FDA Chemical Nickel-Plated Brass Adaptor

6909 Stud Elbow, Male BSPT Thread



Bio-based polymer, FDA chemical nickel-plated brass, EPDM

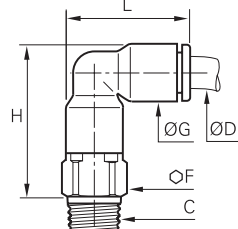

ØD	C		F	G	H	L	kg
4	R1/8	6909 04 10	10	8.5	23	19	0.008
	R1/4	6909 04 13	14	8.5	23.5	19	0.018
6	R1/8	6909 06 10	10	10.5	27	22.5	0.010
	R1/4	6909 06 13	14	10.5	27.5	22.5	0.020
8	R1/8	6909 08 10	13	13.5	33.5	29.5	0.018
	R1/4	6909 08 13	14	13.5	32.5	29.5	0.022
	R3/8	6909 08 17	17	13.5	33	29.5	0.032
10	R1/4	6909 10 13	15	16	39.5	34	0.031
	R3/8	6909 10 17	17	16	39.5	34	0.041
12	R1/2	6909 10 21	21	16	39.5	34	0.060
	R3/8	6909 12 17	19	19	45.5	40.5	0.051
	R1/2	6909 12 21	21	19	45.5	40.5	0.065

The body swivels for positioning purposes.

6998 Stud Branch Tee, Male BSPP and Metric Thread



Bio-based polymer, FDA chemical nickel-plated brass, EPDM

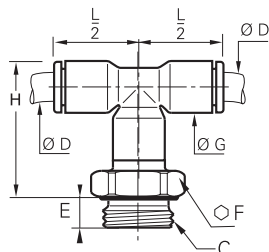

ØD	C		E	F	G	H	L/2	kg
4	M5x0.8	6998 04 19	3.5	8	8.5	24	14	0.006
	G1/8	6998 04 10	5	13	8.5	22	14	0.009
	G1/4	6998 04 13	5.5	16	8.5	22	14	0.014
6	M5x0.8	6998 06 19	3.5	10	10.5	30	16	0.009
	G1/8	6998 06 10	5	13	10.5	29	16	0.011
	G1/4	6998 06 13	5.5	16	10.5	29	16	0.016
8	G1/8	6998 08 10	4.5	13	13.5	38	23	0.019
	G1/4	6998 08 13	5.5	16	13.5	36	23	0.022
	G3/8	6998 08 17	5.5	20	13.5	36	23	0.030
10	G1/4	6998 10 13	5.5	16	16	43	26.5	0.032
	G3/8	6998 10 17	5.5	20	16	43	26.5	0.055
	G1/2	6998 10 21	7.5	24	16	43	26.5	0.051
12	G3/8	6998 12 17	5.5	20	19	45.5	31	0.042
	G1/2	6998 12 21	7	24	19	45.5	31	0.049

These products are available upon request, with minimum order quantity of 100 pieces.
The body swivels for positioning purposes.

6908 Stud Branch Tee, Male BSPT Thread



Bio-based polymer, FDA chemical nickel-plated brass, EPDM

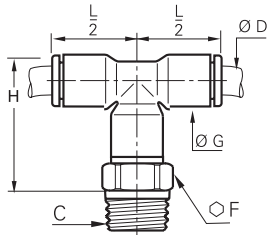

ØD	C		F	G	H	L/2	kg
4	R1/8	6908 04 10	10	8.5	17	14	0.009
	R1/4	6908 04 13	14	8.5	17	14	0.020
6	R1/8	6908 06 10	10	10.5	23	16	0.011
	R1/4	6908 06 13	14	10.5	23	16	0.011
8	R1/8	6908 08 10	13	13.5	30	23	0.020
	R1/4	6908 08 13	14	13.5	30	23	0.025
	R3/8	6908 08 17	17	13.5	30	23	0.036
10	R1/4	6908 10 13	15	16	34.5	26.5	0.033
	R3/8	6908 10 17	17	16	34.5	26.5	0.043
12	R1/2	6908 10 21	21	16	34.5	26.5	0.065
	R3/8	6908 12 17	19	19	40.5	31	0.053
	R1/2	6908 12 21	21	19	40.5	31	0.061

These products are available upon request, with minimum order quantity of 100 pieces.
The body swivels for positioning purposes.

Stud Fittings with FDA Chemical Nickel-Plated Brass Adaptor

6993 Stud Run Tee, Male BSPP and Metric Thread



Bio-based polymer, FDA chemical nickel-plated brass, EPDM

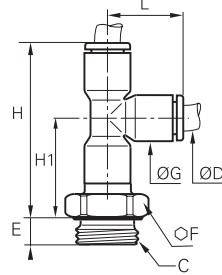

ØD	C		E	F	G	H	H1	L	kg
4	M5x0.8	6993 04 19	3.5	8	8.5	32	19	14.5	0.006
	G1/8	6993 04 10	5	13	8.5	30	18	14.5	0.009
	G1/4	6993 04 13	5.5	16	8.5	30	18	14.5	0.014
6	M5x0.8	6993 06 19	3.5	10	10.5	39	23	17.5	0.009
	G1/8	6993 06 10	5	13	10.5	38	22	17.5	0.011
	G1/4	6993 06 13	5.5	16	10.5	38	22	17.5	0.016
8	G1/8	6993 08 10	4.5	13	13.5	54	31	23	0.019
	G1/4	6993 08 13	5.5	16	13.5	52	29	23	0.022
	G3/8	6993 08 17	5.5	20	13.5	52	29	23	0.030
10	G1/4	6993 10 13	5.5	16	16	61	35	26.5	0.032
	G3/8	6993 10 17	5.5	20	16	61	35	26.5	0.055
	G1/2	6993 10 21	7.5	24	16	61	35	26.5	0.051
12	G3/8	6993 12 17	5.5	20	19	67	36	31	0.042
	G1/2	6993 12 21	7	24	19	67	36	31	0.049

These products are available upon request, with minimum order quantity of 100 pieces.
The body swivels for positioning purposes.

6903 Stud Run Tee, Male BSPT Thread



Bio-based polymer, FDA chemical nickel-plated brass, EPDM

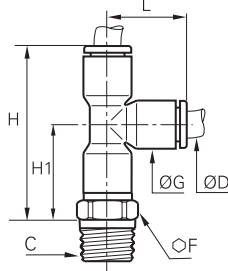

ØD	C		F	G	H	H1	L	kg
4	R1/8	6903 04 10	10	8.5	31	18	14.5	0.009
	R1/4	6903 04 13	14	8.5	31	19	14.5	0.020
6	R1/8	6903 06 10	10	10.5	38	22	17.5	0.011
	R1/4	6903 06 13	14	10.5	39	23	17.5	0.011
8	R1/8	6903 08 10	13	13.5	53	30	23	0.020
	R1/4	6903 08 13	14	13.5	52	29	23	0.025
10	R3/8	6903 08 17	17	13.5	52	29	23	0.036
	R1/4	6903 10 13	15	16	61	35	26.5	0.033
	R3/8	6903 10 17	17	16	61	35	26.5	0.043
12	R1/2	6903 10 21	21	16	61	35	26.5	0.065
	R3/8	6903 12 17	19	19	70	39	31	0.053
	R1/2	6903 12 21	21	19	70	39	31	0.061

These products are available upon request, with minimum order quantity of 100 pieces.
The body swivels for positioning purposes.

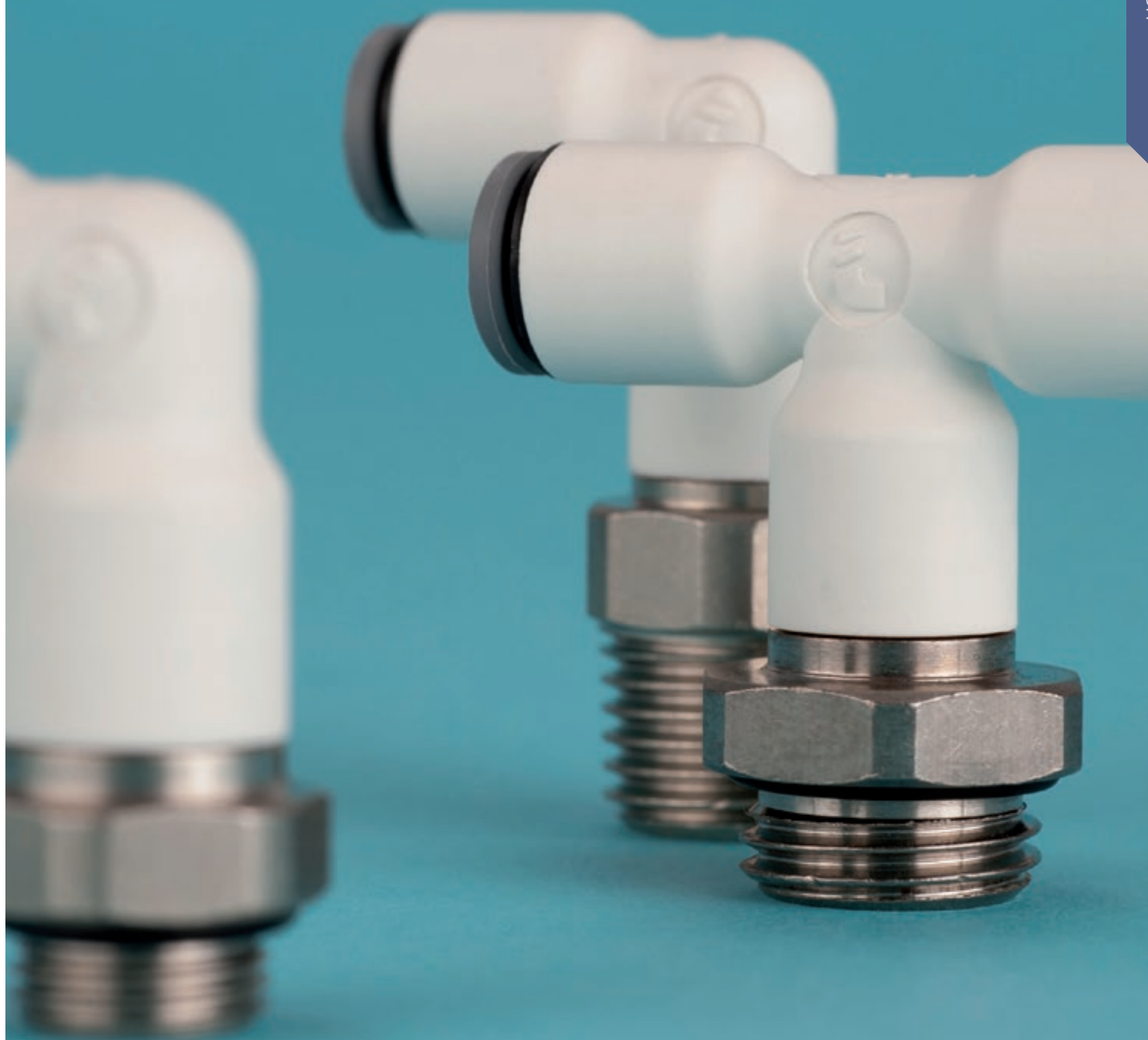



Connectors for Optic Fibre Cable

Direct Buried Connectors and End Caps

6270
Page 1-75

6270..03
Page 1-75

6273
Page 1-75

6273..03
Page 1-75



Direct Install Connectors and End Caps

6271
Page 1-77

6271..03
Page 1-77

3151
Page 1-77

3151..03
Page 1-77



Passive Gas Block Connectors

6274
Page 1-79



Accessories for Direct Buried and Direct Install Connectors

3130
Page 1-81

6276
Page 1-81



Direct Buried Connectors

The new Parker Legris connectors were developed to optimise installation and provide long-term **integrity for underground FTTx* networks**.



*FTTx: Fibre To The x = home, building, campus, etc.

Product Advantages

Optimised Installation

- Transparent: optic fibre ducts and correct tube connection can be seen and verified
- Patented ridged design for unsurpassed shock resistance
- No protection cap necessary
- 1 connector for 2 different wall thicknesses of the tubing (bridging possible between direct buried and direct install micro-tubing)
- Compact design and intuitive installation
- Pre-assembled safety clip to prevent risk of accidental disconnection
- High working pressure for increased blowing speed/distance

Longevity & Reliability

- Tried-and-tested connection technology to ensure tensile strength and resistance to network expansion
- Perfect sealing IP68: full protection against particle ingress
- UL94: flame resistance for indoor installations
- Date coding to guarantee quality and traceability
- 100% leak-tested in production



Underground Networks
Micro-Tubing
Air Blowing
Water Floating
Heavy Duty Ducting

Applications

Technical Characteristics

Compatible Fluids	Air, water
Working Pressure	Vacuum to 25 bar
Working Temperature	-20°C to +80°C
Suitable Ducts	Direct buried micro-tubing Direct install micro-tubing
Shock Resistance	Conforms to standard and light applications according to the NF EN 61386-24 standard
Tubing Diameter	Ø 7 mm to Ø 14 mm

Use is guaranteed with a vacuum of 755 mm Hg (99% vacuum).

Component Materials

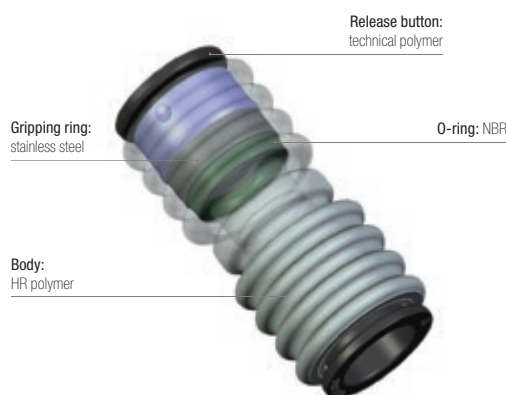

Regulations and Intellectual Property

ISO 14743: Pneumatic fluid power, push-in connectors for thermoplastic tubes
NF EN 50086-2-4 replaced by NF EN 61386-24: Standard relating to impact tests for buried systems
UL94: Flame resistance

IP68: Seepage resistance to water and dust
Patent family FR2980999 (buried connectors)
Patent family FR2924194 (safety clips)

Direct Buried Connectors

6270

Equal and Unequal Tube-to-Tube Connector

HR polymer, NBR

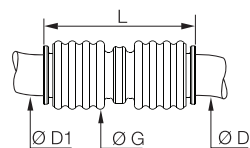

ØD	ØD1		G	L	Kg
7	7	6270 07 00	16	38	0.006
8	8	6270 08 00	16	39	0.006
10	10	6270 10 00	20	43	0.009
	12	6270 10 12	22	50	0.010
12	12	6270 12 00	22	50	0.009
	14	6270 12 14	24	56	0.022
14	14	6270 14 00	24	56	0.022

16 mm also available upon request

6270..03

Equal and Unequal Tube-to-Tube Connector with Red Tamper-Proof Safety Clips

HR polymer, NBR

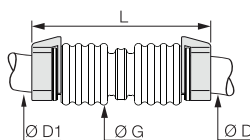

ØD	ØD1		G	L	Kg
7	7	6270 07 00 03	16	47	0.007
8	8	6270 08 00 03	16	48	0.007
10	10	6270 10 00 03	20	51	0.011
	12	6270 10 12 03	22	60	0.026
12	12	6270 12 00 03	22	60	0.017
	14	6270 12 14 03	24	68	0.031
14	14	6270 14 00 03	24	68	0.023

This product is available on request only.

6273

End Cap

HR polymer, NBR

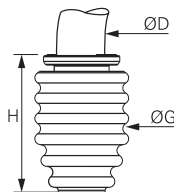

ØD		G	H	Kg
7	6273 07 00	16	23	0.002
8	6273 08 00	16	24	0.002
10	6273 10 00	20	26	0.003
12	6273 12 00	22	30	0.006
14	6273 14 00	24	33	0.014

16 mm also available upon request

6273..03

End Cap with Red Tamper-Proof Safety Clip

HR polymer, NBR

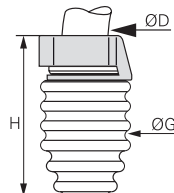

ØD		G	H	Kg
7	6273 07 00 03	16	28	0.003
8	6273 08 00 03	16	29	0.003
10	6273 10 00 03	20	31	0.005
12	6273 12 00 03	22	35	0.009
14	6273 14 00 03	24	39	0.018

This product is available on request only.

Direct Install Connectors

A range of high performance connectors dedicated to direct install systems for FTTx* to guarantee **easy use** and **long service time**.



*FTTx: Fibre To The x = home, building, campus, etc.

Product Advantages

Optimised Installation

- Reliable technology of push-in connection
- Minimum distance between two tubes when connected, eliminating the risk of blockage during blowing
- 1 connector for 2 different wall thicknesses of the tubing (bridging possible between direct buried and direct install micro-tubing)
- Ultra compact design and intuitive installation
- Safety clip for preventing risk of accidental disconnection

Longevity & Reliability

- Tried-and-tested connection technology to ensure capability to expand network
- Perfect sealing IP68: full protection against particle ingress
- UL94 V-2: flame resistance for indoor installations
- Date coding to guarantee quality and traceability
- 100% leak-tested in production



Direct Install Networks
Micro-Tubing
Air Blowing
Aerial Ducting
Sub-Ducts

Applications

Technical Characteristics

Compatible Fluids	Air, water
Working Pressure	Vacuum to 15 bar
Working Temperature Storage temperature	-15°C to +45°C -20°C to +80°C
Suitable Ducts	Direct install microduct
Tubing Diameter	Ø 5 mm to Ø 14 mm

Use is guaranteed with a vacuum of 755 mm Hg (99% vacuum).

Component Materials



Regulations and Intellectual Property

- ISO 14743: Pneumatic fluid power, push-in connectors for thermoplastic tubes
- IP68: Seepage resistance to water and dust
- UL94 V-2: Flame resistance
- Patent family FR2924194 (safety clips)

Direct Install Connectors and End Caps

6271 Equal Tube-to-Tube Connector

HR polymer, NBR

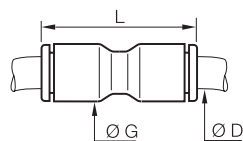

ØD		G	L	Kg
5	6271 05 00	10.5	30	0.002
7	6271 07 00	13.5	38	0.004
8	6271 08 00	13.5	38	0.004
10	6271 10 00	16	42	0.006
12	6271 12 00	19	50.5	0.009
14	6271 14 00	22	56	0.014

16 mm also available upon request

6271..03 Equal Tube-to-Tube Connector with Red Tamper-Proof Safety Clips

HR polymer, NBR

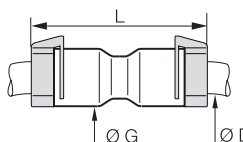

ØD		G	L	Kg
5	6271 05 00 03	10.5	38	0.007
7	6271 07 00 03	13.5	47	0.007
8	6271 08 00 03	13.5	48	0.007
10	6271 10 00 03	16	51	0.011
12	6271 12 00 03	19	60	0.017
14	6271 14 00 03	22	68	0.025

This product is available on request only.

3151 End Cap

Technical polymer, NBR

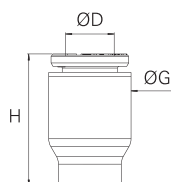

ØD		G	H	Kg
5	3151 05 00	10.5	17	0.001
7	3151 07 00	13.5	22	0.003
8	3151 08 00	13.5	22	0.003
10	3151 10 00	16	22	0.005
12	3151 12 00	19	28	0.009
14	3151 14 00	22	31	0.018

Technical specifications of LF 3000® push-in fittings.

3151..03 End Cap with Tamper-Proof Safety Clip

Technical polymer, NBR

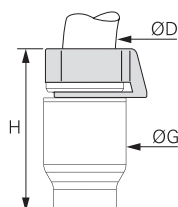

ØD		G	H	Kg
5	3151 05 00 03	10.5	20	0.002
7	3151 07 00 03	13.5	26	0.004
8	3151 08 00 03	13.5	26	0.004
10	3151 10 00 03	16	27	0.007
12	3151 12 00 03	19	33	0.011
14	3151 14 00 03	22	35	0.022

This product is available on request only.

Technical specifications of LF 3000® push-in fittings.

Related Products

- Tube Cutters: see chapter "Technical Tubes and Hoses"

[3000 71 00](#) P. 3-46

[3000 71 11](#) P. 3-46

Passive Gas Block Connector

Easy-to-use product, providing **quick** and **efficient** sealing of the end of the FTTx* network and thereby long-term protection of the installation.



*FTTx: Fibre To The x = home, building, campus, etc.

Product Advantages

- Stock Optimisation** | More possibilities with fewer references
 1 connector allows for several microduct/fibre cable combinations
- Easy Handling** | Optic fibre cable visible as it passes through seal, allowing for considerable time-saving
 Visual connection indication
 100% push-in technology with optic fibre cable sealing
 Ultra compact design
- Longevity & Reliability** | Unique design guaranteeing maximum safety of use
 Gas and watertight up to 1 bar
 UL94 V-2: flame resistance for indoor installations
 Safety clip for preventing risk of accidental disconnection



Applications

- Underground Networks
- Micro-Tubing
- Air Blowing
- Water Floating
- Heavy Duty Ducting

Technical Characteristics

Compatible Fluids	Air, water
Sealing Level	1 bar
Working Temperature Storage Temperature	-15°C to +45°C -20°C to +80°C
Suitable Ducts	Direct buried and direct install microducts
Tubing Diameter	Ø 5 mm to Ø 14 mm

Component Materials



Regulations

ISO 14743: Pneumatic fluid power, push-in connectors for thermoplastic tubes
 IP68: Seepage resistance to water and dust
 UL94 V-2: Flame resistance for indoor installation or hazardous zones
 Patent family FR2924194 (gas block)

Passive Gas Block Connector

6274

Passive Gas Block Connector

HR polymer, NBR

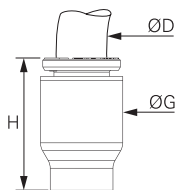

ØD		G	H	Kg
5	6274 05 00	10.5	17	0.001
7	6274 07 00	13.5	22	0.003
10	6274 10 00	16	22	0.005
12	6274 12 00	19	28	0.009
14	6274 14 00	22	31	0.018

Installation Process



1. Slide the Gas Block Connector onto the optic fibre cable.



Centering and turning the connector facilitates the passage of the largest optic fibre cable possible through the Gas Block.



2. Push the connector onto the microduct tubing.

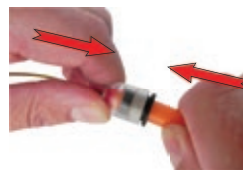

3. Press the connector very firmly, straight onto the tubing, and compress the seal.



4. Check: the optic fibre cable should be held tightly by the seal.
The cable can still slide, allowing its length to be adjusted out of the Gas Block if necessary.

Microduct/Fibre Cable Combination

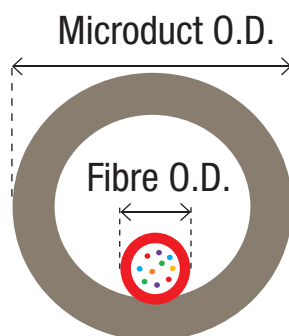

We recommend the use of a safety clip in order to prevent accidental disconnection.

Connector / Microduct O.D (mm)	Fibre O.D. (mm)
5	1 to 2.5
7	1 to 4
10	1.4 to 6.5
12	3 to 8,6
14	3 to 9

Accessories for Direct Buried and Direct Install Connectors

Parker Legris has designed different accessories to improve **safety** and allow circuit **identification**.

Product Advantages

Tamper-Proof Safety Clip

- Prevents accidental disconnection
- Disconnection only possible with tooling
- Resistant to grease and cleaning agents
- Colour-coding for tube identification (6 colours)
- Adapted to suit all installation configurations



Detectable Buried End Cap

- Easy detection of loose underground network's termination
- Cost and time saving when maintaining or expanding the network
- Metal cover locks to plastic end cap during microduct connection to enable visual detection of correct positioning over time

- Applications**
- Underground Networks
 - Micro-Tubing
 - Air Blowing
 - Water Floating
 - Heavy Duty Ducting

Technical Characteristics

	Detectable Buried End Cap
Working Temperature	Vacuum to 25 bar
Working Temperature	-20°C to +80°C
Suitable Ducts	Direct install and direct buried
Tubing Diameter	Ø 7 mm to Ø 14 mm

Component Materials

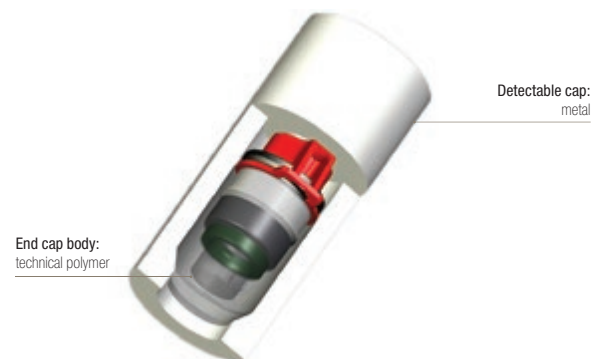

Installation Process

Tamper-Proof Safety Clip

Connection



1. Assemble the clip



2. Connect the tubing

Disconnection



1. Cut the clip with pliers

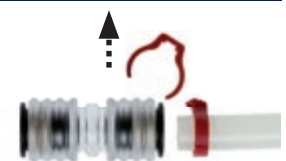

2. Remove the clip and tubing

Detectable Buried End Cap



1. A cap, a clip and a metal cover



2. Assemble the clip on the cap



3. Mount the cap within the metal cover



4. Connect the tube

Accessories for Direct Buried and Direct Install Connectors

3130 Tamper-Proof Safety Clip

Technical polymer

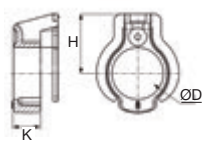

ØD							H	K	Kg
4	3130 04 01	3130 04 02	3130 04 03	3130 04 04	3130 04 05	3130 04 10	6.5	3	0.001
6	3130 06 01	3130 06 02	3130 06 03	3130 06 04	3130 06 05	3130 06 10	8	3	0.001
8	3130 08 01	3130 08 02	3130 08 03	3130 08 04	3130 08 05	3130 08 10	9.5	4.3	0.001
10	3130 10 01	3130 10 02	3130 10 03	3130 10 04	3130 10 05	3130 10 10	10.8	4.2	0.001
12	3130 12 01	3130 12 02	3130 12 03	3130 12 04	3130 12 05	3130 12 10	12.5	5.1	0.004
14	3130 14 01	3130 14 02	3130 14 03	3130 14 04	3130 14 05	3130 14 10	15	6	0.004

6276 Detectable Buried End Cap

Technical polymer, steel, NBR

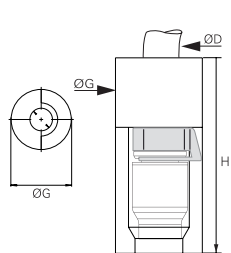

ØD		G	H	Kg
7	6276 07 00	20	45	0.054
8	6276 08 00	20	45	0.054
10	6276 10 00	22	45	0.043
12	6276 12 00	24	50	0.064
14	6276 14 00	27.5	60	0.065

This product is available on request only.

Bridging of O.D./I.D. Connector

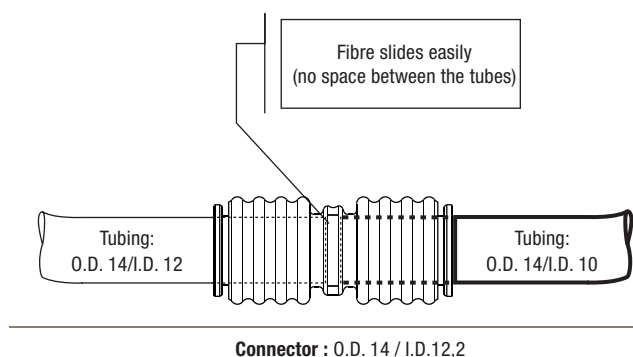

Connector O.D. (mm)/ I.D. (mm)	Tube O.D. (mm)	Tube I.D. (mm)
5 / 4	5	2.1 to 3.8
7 / 5.7	7	3 to 5.5
8 / 6.2	8	3.5 to 6
10 / 8.2	10	5.5 to 8
12 / 12.2	12	8 to 10
14 / 12.2	14	9,6 to 12

Prestomatic Push-In Fittings

Prestomatic 3 Fittings

Elbows

C68UNPMK
Page 1-85



V68UNPMK
Page 1-85



Tees

R68UNPMK
Page 1-85



JNPMK
Page 1-85



Prestomatic 2 Stud Fittings

Straights

F8UNPMB
Page 1-87



F2NPMB
Page 1-87



WEONPMB
Page 1-87



Elbows

C8UNPMB
Page 1-88



V8UNPMB
Page 1-88



Tees

S8UNPMB
Page 1-88



S8UNPMBPPAM
Page 1-88



Prestomatic 2 Tube-to-Tube Fittings

Straights

HNPMB
Page 1-89



WNPMB
Page 1-89



Elbow

T2ENPMB
Plug-In
Page 1-89



Tee

JNPMB
Page 1-89



Adaptors and Accessories for Braking Systems

Elbows

D8C8UB
Page 1-90



D8V8UB
Page 1-90



Tees

MR08UB
Page 1-90



MMS8UB
Page 1-90



MM08BKT
Page 1-90



Increasesrs

F8UG8B
Page 1-91



Reducers

F8UG8B
Page 1-91



Conversion Fittings

F8UGB
Metric Male / NPT Female
Page 1-91



F8UG4B
Metric Male / BSPP Female
Page 1-91



Straight Connectors

F8UHA8UB
Page 1-91



Bulkhead Connector Fittings

WGG88B
Page 1-92



WG8F8UB
Page 1-92



Test Points

PPRF8UM
Page 1-92



PPRC8UM
Page 1-92



PPRV8UM
Page 1-92



Plugs and Accessories

P8UNBL
Page 1-93



3126
Page 1-93



VDPF8UM
Drain valve
Page 1-93



WLNB
Page 1-93



Prestomatic 3 Push-In Fittings

In order to meet **severe** and **demanding** conditions of use in air circuits in rail and road transportation, this range of **lightweight** polyamide fittings offers **excellent technical performance** and respects the new environmental requirements.

Product Advantages

- Optimum Design**
- Extreme compactness for space-saving
 - Weight reduction over traditional airbrake fittings
 - Integrated polymer tube support gives tube alignment and tube retention for:
 - excellent resistance to vibration
 - sealing ensured over time
 - Fully re-usable; reduces maintenance costs
- High Performance**
- Positive hold by an innovative gripping ring design allowing absorption of vibration and pulsating pressure
 - Excellent mechanical properties adapted to demanding working conditions
 - UV-resistant polymer guarantees a long lifespan
 - Twist-free assembly allowing free tube rotation even under pressure and high resistance to tube expansion
 - Extreme temperature resistance for increased lifespan
- Reliability**
- 100% leak-tested in production
 - Date coding to guarantee quality and traceability
 - Suitable with flexible tubing in braking system



Air Braking Systems
Air Suspension
Chassis
Engine Braking
Gearbox
Pantograph
Motricity Control

Applications

Technical Characteristics

Compatible Fluids	Compressed air
Working Pressure	25 bar
Working Temperature	-40°C to +100°C For lower temperature applications, please consult us

Tightening Torques (daN.m)	Threads				
	M10x1	M12x1.5	M14x1.5	M16x1.5	M22x1.5
	8 to 10	10 to 20	15 to 20	15 to 20	20 to 30

Male metric threads conform to DIN 3852-1, DIN 3852-3, ISO 4039-2 and ISO 6149-1 standards.

Component Materials

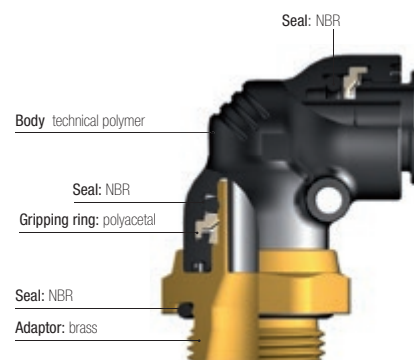

Silicone-free

Regulations

Fully adapted to transportation braking system applications with tubing conformed to:
DIN 74324-1
DIN 73378
NF-R12-632-2

Prestomatic 3 Push-In Fittings

C68UNPMK

90° Elbow, Male Metric Thread

Technical polymer, brass, NBR

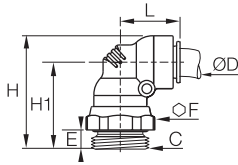

ØD	C		E	F	H	H1	L	Kg
8	M12x1.5	C68UNPMK8M12	7.5	17	40	31	20.5	0.024
	M14x1.5	C68UNPMK8M14	7.5	19	40	31	20.5	0.027
	M16x1.5	C68UNPMK8M16	8	22	41	32	20.5	0.034
	M22x1.5	C68UNPMK8M22	8	27	41	32	20.5	0.046
10	M12x1.5	C68UNPMK10M12	7.5	17	47	36	25	0.031
	M16x1.5	C68UNPMK10M16	8	22	47	37	25	0.043
12	M22x1.5	C68UNPMK10M22	8	27	48	38	25	0.062
	M12x1.5	C68UNPMK12M12	7.5	17	49	37.5	26	0.035
	M16x1.5	C68UNPMK12M16	8	22	50	38.5	26	0.047
16	M22x1.5	C68UNPMK12M22	8	27	50	37.5	26	0.058
	M16x1.5	C68UNPMK16M16	8	22	53	39.5	27	0.059
	M22x1.5	C68UNPMK16M22	8	27	53	39.5	27	0.070

The body swivels for positioning purposes.

V68UNPMK

45° Elbow, Male Metric Thread

Technical polymer, brass, NBR

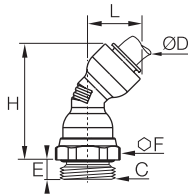

ØD	C		E	F	H	L	Kg
10	M22x1.5	V68UNPMK10M22	8	27	61	23	0.060
12	M16x1.5	V68UNPMK12M16	8	22	63	24.5	0.045
	M22x1.5	V68UNPMK12M22	8	27	62	24.5	0.057
16	M22x1.5	V68UNPMK16M22	8	27	66	27	0.071

The body swivels for positioning purposes.

R68UNPMK

Stud Run Tee, Male Metric Thread

Technical polymer, brass, NBR

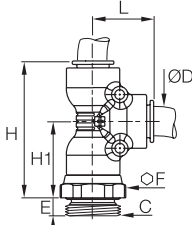

ØD	C		E	F	H	H1	L	Kg
8	M12x1.5	R68UNPMK8M12	7.5	17	51	31	20.5	0.028
12	M16x1.5	R68UNPMK12M16	8	22	64.5	38.5	26	0.053
16	M16x1.5	R68UNPMK16M16	8	22	68	39.5	27	0.067

The body swivels for positioning purposes.

JNPMK

Equal Tee

Technical polymer, NBR

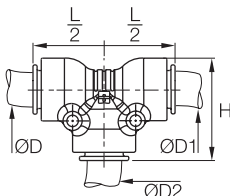

ØD	ØD1	ØD2		H	L/2	Kg
8	8	8	JNPMK8	30	20.5	0.012
10	10	10	JNPMK10	35.5	25	0.019
12	12	12	JNPMK12	37.5	26	0.022
16	16	16	JNPMK16	41	27	0.028

Other Configurations Available on Request



F Male Elbow



90° Male Side Tee



Male Branch Tee



Male Branch Tee
In-Line Test Point



ISO 8434-1 Bulkhead Tee

Prestomatic 2 Push-In Fittings

To meet **severe** and **demanding applications** such as pneumatic circuits in rail and road transportation, Prestomatic 2 fittings conform to the international standards offering **robustness, reliability** and **mechanical resistance**.

Product Advantages

- Versatility** | Extreme compactness for space-saving
 High robustness
 Excellent mechanical properties adapted to severe working conditions
 Integrated metallic tube support reinforces tube alignment and tube retention for:
- excellent resistance to vibration
 - sealing ensured over time
 - increased resistance to tube removal
- Fully re-usable to reduce maintenance costs
- High Performance** | Positive hold by an innovative gripping ring design allowing absorption of vibration and pulsating pressure
 Twist-free assembly allowing free tube rotation even under pressure and high resistance to tube expansion
 Extreme temperature resistance: up to -50°C for increased lifespan
- Reliability** | 100% leak-tested in production
 Date coding to guarantee quality and traceability
 Suitable with flexible tubing in braking system



Applications

- Air Braking Systems
- Air Suspension
- Chassis
- Engine Braking
- Gearbox
- Pantograph
- Motricity Control

Technical Characteristics

Compatible Fluids	Compressed air
Working Pressure	25 bar
Working Temperature	-40°C to +100°C For lower temperature applications, please consult us

Tightening Torques (daN.m)	Threads				
	M10x1	M12x1.5	M14x1.5	M16x1.5	M22x1.5
	8 to 10	10 to 20	15 to 20	15 to 20	20 to 30

Male metric threads conform to DIN 3852-1, DIN 3852-3, ISO 4039-2 and ISO 6149-1 standards.

Component Materials

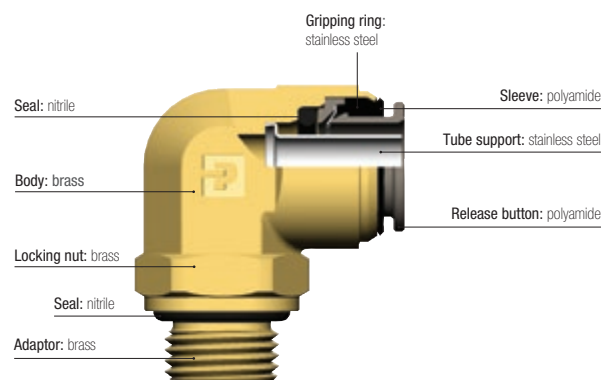

Silicone-free

Regulations

EN 45545-2: HL3, R22, R24, R25 classification can be attained when used with fireproof tubing

Fully adapted to transportation braking system applications with tubing:
 DIN 74324-1
 DIN 73378
 NF-R12-632-2

Stud Fittings

F8UNPMB

Stud Fitting, Male Metric Thread

Brass, NBR

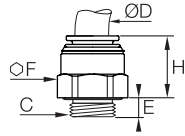

ØD	C		E	F	H	Kg
6	M10x1	F8UNPMB6M10	7	16	18.5	0.018
	M12x1.5	F8UNPMB6M12	7.5	17	16	0.017
	M16x1.5	F8UNPMB6M16	8	22	14.5	0.032
	M22x1.5	F8UNPMB6M22	8	27	13.5	0.053
8	M12x1.5	F8UNPMB8M12	7.5	17	19.5	0.021
	M14x1.5	F8UNPMB8M14	7.5	19	18	0.025
	M16x1.5	F8UNPMB8M16	8	22	15	0.030
	M22x1.5	F8UNPMB8M22	8	27	13.5	0.052
10	M12x1.5	F8UNPMB10M12	7.5	22	22.5	0.036
	M14x1.5	F8UNPMB10M14	7.5	22	22	0.036
	M16x1.5	F8UNPMB10M16	8	22	20.5	0.038
	M22x1.5	F8UNPMB10M22	8	27	14.5	0.049
12	M12x1.5	F8UNPMB12M12	7.5	22	22.5	0.035
	M16x1.5	F8UNPMB12M16	8	22	21	0.033
	M22x1.5	F8UNPMB12M22	8	27	17.5	0.052
	M16x1.5	F8UNPMB16M16	8	27	22.5	0.063
16	M22x1.5	F8UNPMB16M22	8	27	22.5	0.069

F2NPMB

Stud Fitting, Male NPT thread

Brass, NBR

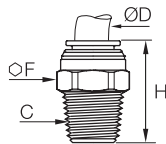

ØD	C		F	H	Kg
6	NPT1/8	F2NPMB6-1/8	16	25	0.015
	NPT1/4	F2NPMB6-1/4	16	25	0.020
	NPT3/8	F2NPMB6-3/8	19	27	0.037
8	NPT1/4	F2NPMB8-1/4	17	30	0.025
	NPT3/8	F2NPMB8-3/8	19	27	0.033
10	NPT1/4	F2NPMB10-1/4	22	35.5	0.044
	NPT1/2	F2NPMB10-1/2	22	34	0.066
12	NPT3/8	F2NPMB12-3/8	22	31	0.038
	NPT1/2	F2NPMB12-1/2	22	34	0.058

WEONPMB

Equal Mixed Bulkhead Adapter

Brass, NBR

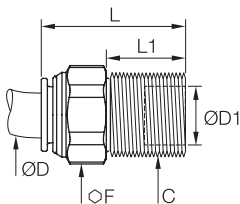

ØD	ØD1	C		F	L	L1	Kg
8	8	M14x1.5	WEONPMB8-8L	19	36	21	0.033
	10	M16x1.5	WEONPMB8-10L	19	36	21	0.038
	12	M18x1.5	WEONPMB8-12L	22	34	21	0.046
12	12	M18x1.5	WEONPMB12-12L	22	37	21	0.046

Other Configurations Available on Request



Male Bulkhead



Male Run Tee



F Male Elbow



ISO 8434-1 Bulkhead Elbow



Male Run Tee Branch Test Point

Stud Fittings

C8UNPMB

90° Elbow, Male Metric Thread

Brass, NBR

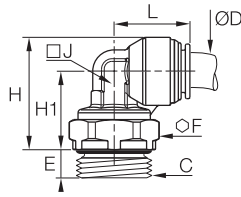

ØD	C		E	F	H	H1	J	L	Kg
6	M10x1	C8UNPMB6M10	7.5	14	24	16	10	22	0.032
	M12x1.5	C8UNPMB6M12	9	17	25.5	17	11	22	0.038
	M16x1.5	C8UNPMB6M16	9.5	22	30	20	13	23	0.062
8	M22x1.5	C8UNPMB6M22	9.5	27	35	24	14	23	0.095
	M12x1.5	C8UNPMB8M12	9	17	25.5	17	11	22	0.039
	M14x1.5	C8UNPMB8M14	9.5	19	26.5	18	11	22	0.046
10	M16x1.5	C8UNPMB8M16	9.5	22	30	20	13	23	0.061
	M22x1.5	C8UNPMB8M22	9.5	27	35	24	14	23	0.092
	M16x1.5	C8UNPMB10M16	9.5	22	30.5	20.5	13	25	0.063
12	M22x1.5	C8UNPMB10M22	9.5	27	37	26	14	25	0.099
	M12x1.5	C8UNPMB12M12	9	17	32	21	14	25	0.063
	M16x1.5	C8UNPMB12M16	9.5	22	33	22	14	25	0.072
16	M22x1.5	C8UNPMB12M22	9.5	27	37	26	14	25	0.095
	M16x1.5	C8UNPMB16M16	9.5	22	37	23.5	24	34	0.170
	M22x1.5	C8UNPMB16M22	9.5	27	39	25.5	24	34	0.174

The body can be locked in the desired orientation with the locknut.

V8UNPMB

45° Elbow, Male Metric Thread

Brass, NBR

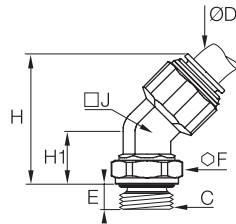

ØD	C		E	F	H	H1	J	Kg
8	M16x1.5	V8UNPMB8M16	9.5	22	38	17.5	14	0.063
10	M22x1.5	V8UNPMB10M22	9.5	27	44	21	14	0.085
12	M16x1.5	V8UNPMB12M16	9.5	22	44	17.5	14	0.074
	M22x1.5	V8UNPMB12M22	9.5	27	48	21	14	0.095
16	M22x1.5	V8UNPMB16M22	9.5	27	42	18	22	0.106

The body can be locked in the desired orientation with the locknut.

S8UNPMB

Stud Branch Tee, Male Metric Thread

Brass, NBR

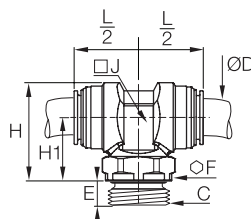

ØD	C		E	F	H	H1	J	L/2	Kg
8	M16x1.5	S8UNPMB8M16	9.5	22	39	27	14	24	0.097
	M22x1.5	S8UNPMB8M22	9.5	27	42	30.5	14	24	0.118
10	M16x1.5	S8UNPMB10M16	9.5	22	39	27	14	25.5	0.100
	M22x1.5	S8UNPMB10M22	9.5	27	42	30.5	14	25.5	0.118
12	M16x1.5	S8UNPMB12M16	9.5	22	39	27	14	27	0.110
	M22x1.5	S8UNPMB12M22	9.5	27	42	30.5	14	27	0.131
16	M22x1.5	S8UNPMB16M22	9.5	27	40	26	19	27	0.171

The body can be locked in the desired orientation with the locknut.

S8UNPMBPPAM

Stud Branch Tee, Male Metric Thread, In-Line Test Point

Brass, NBR

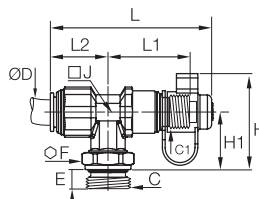

ØD	C	C1		E	F	H	H1	J	L	L1	L2	Kg
10	M16x1.5	M16x1.5	S8UNPMB10PPAM16	9.5	22	45	27	14	71	36	25	0.125
12	M16x1.5	M16x1.5	S8UNPMB12PPAM16	9.5	22	45	27	14	75	38	27	0.133
	M22x1.5	M16x1.5	S8UNPMB12PPAM22	9.5	27	48.5	30.5	14	75	38	27	0.154

The body can be locked in the desired orientation with the locknut.

Tube-to-Tube Fittings

HNPMB

Equal Connector

Brass, NBR

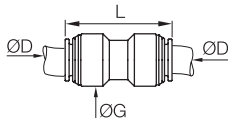

ØD		G	L	Kg
6	HNPMB6	16	37.5	0.024
8	HNPMB8	18	37	0.029
10	HNPMB10	20	41	0.036
12	HNPMB12	22	41	0.041
16	HNPMB16	27	41	0.078

WNPMB

Equal Bulkhead Connector

Brass, NBR

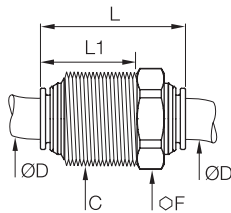

ØD	C		F	L	L1	Kg
6	M18x1.5	WNPMB6	22	39.5	26	0.056
8	M20x1.5	WNPMB8	22	39	26	0.061
10	M22x1.5	WNPMB10	24	43	28	0.076
12	M24x1.5	WNPMB12	27	44	29	0.091

T2ENPMB

Equal and Unequal 90° Plug-In Elbow

Brass, NBR

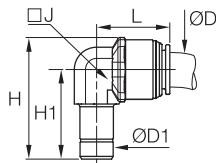

ØD	ØD1		H	H1	J	L	Kg
6	8	T2ENPMB6	36	27.5	10	21	0.025
8	8	T2ENPMB8	36	27.5	10	22	0.025
10	12	T2ENPMB10	44	32.5	14	25.5	0.049
12	12	T2ENPMB12	44	32.5	14	27	0.051

JNPMB

Equal and Unequal Tee

Brass, NBR

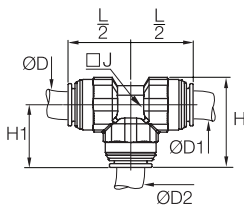

ØD	ØD1	ØD2		H	H1	J	L/2	Kg
6	6	6	JNPMB6	30	22	12	22	0.044
8	8	8	JNPMB8	31	23	12	23	0.050
		12	JNPMB8-8-12	37	25	14	23	0.077
10	10	10	JNPMB10	37	25.5	14	25.5	0.086
		6	JNPMB10-10-6	36	24	14	23	0.073
		10	JNPMB10-6-10	37	25.5	14	25.5	0.083
12	12	12	JNPMB12	38	26.5	14	26.5	0.093
		6	JNPMB12-12-6	35	24	14	26	0.086
		8	JNPMB12-12-8	35	24	14	26	0.085
16	16	16	JNPMB16	46	29	30	29	0.189

Air Brake Adaptors

D8C8UB

90° Elbow, Male/Female Metric Thread

Brass, NBR

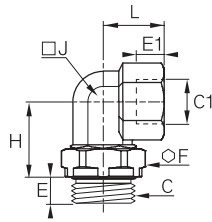

C	C1		E	E1	F	H	J	L	Kg
M16x1.5	M16x1.5	M16M16D8C8UB	9.5	10	22	23.5	16	18.5	0.081
M22x1.5	M16x1.5	M16M22D8C8UB	10.5	10	27	26.5	19	21.5	0.132
	M22x1.5	M22D8C8UB	10.5	12	27	29.5	19	23.5	0.134

The body can be locked in the desired orientation with the locknut.

D8V8UB

45° Elbow, Male/Female Metric Thread

Brass, NBR

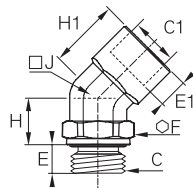

C	C1		E	E1	F	H	H1	J	Kg
M16x1.5	M16x1.5	M16M16D8V8UB	9.5	10	22	15.5	22	17	0.077

The body can be locked in the desired orientation with the locknut.

MR08UB

Female Run Tee, Male Metric Thread

Laiton, NBR

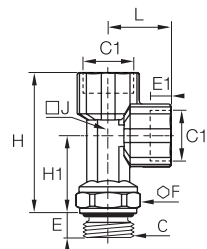

C	C1		E	E1	F	H	H1	J	L	Kg
M12x1.5	M12x1.5	M12MR08UB	9	10	17	50.5	30	14	20.5	0.117
M16x1.5	M16x1.5	M16MR08UB	10	10	22	62.5	39	14	23.5	0.134
M22x1.5	M16x1.5	M16M22M16MR08UB	10.5	10	27	65	41.5	14	23.5	0.178
	M22x1.5	M22MR08UB	10.5	12	27	69.5	41.5	18	28	0.222

The body can be locked in the desired orientation with the locknut.

MMS8UB

Branch Tee, Male/Female Metric Thread

Brass, NBR

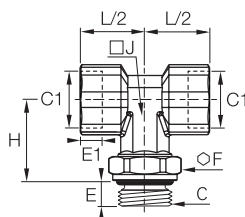

C	C1		E	E1	F	H	J	L/2	Kg
M12x1.5	M12x1.5	M12MMS8UB	9	10	17	25.5	14	23.5	0.140
M16x1.5	M16x1.5	M16MMS8UB	10	10	22	29	14	23.5	0.134
M22x1.5	M16x1.5	M16M16M22MMS8UB	10.5	10	27	31	14	23.5	0.175

The body can be locked in the desired orientation with the locknut.

MM08BKT

Tee with Mounting Boss, Female Metric Thread

Brass, NBR

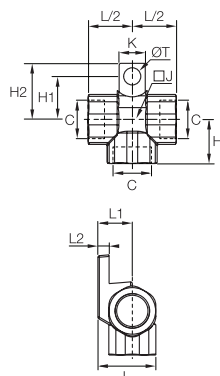

C		H	H1	H2	J	K	L	L1	L2	L/2	ØT	Kg
M16x1.5	M16MM08BKT	20.5	26	20	19	12	27	16	5	20.5	8	0.112

Air Brake Adaptors and Accessories

F8UG8B

Increaser, Male/Female Metric Thread

Brass, NBR

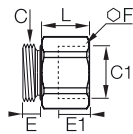



C	C1		E	E1	F	L	Kg
M12x1.5	M16x1.5	 M12M16F8UG8B	7.5	10	22	17.5	0.044

F8UG8B

Reducer, Male/Female Metric Thread

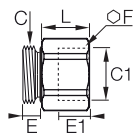
Brass, NBR





C	C1		E	E1	F	L	Kg
M16x1.5	M12x1.5	 M16M12F8UG8B	8	10	22	15	0.051
M22x1.5	M16x1.5	 M22M16F8UG8B	8	10	27	16	0.073

F8UGB

Conversion Fitting, Male Metric/Female NPT Thread

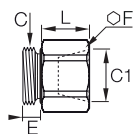
Brass, NBR





C	C1		E	F	L	Kg
M16x1.5	NPT1/4	 M16-1/4F8UGB	8	22	15	0.050
M22x1.5	NPT3/8	 M22-3/8F8UGB	8	27	18	0.080

F8UG4B

Conversion Fitting, Male Metric/Female BSPP Thread

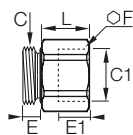
Brass, NBR







C	C1		E	E1	F	L	Kg
M16x1.5	G1/4	 M16-1/4F8UG4B	8	10	22	11.5	0.038
	G1/8	 M16-1/8F8UG4B	8	7	22	8	0.031

F8UHA8UB

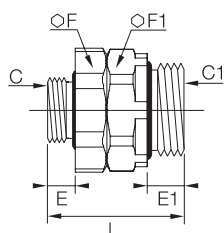
Straight Male Adaptor, Male Metric Thread

Brass, NBR



C	C1		E	E1	F	F1	L	Kg
M16x1.5	M16x1.5	 M16F8UHA8UB	8	10	22	22	32	0.056
	M22x1.5	 M16M22F8UHA8UB	8	10.5	27	27	36	0.096
M22x1.5	M22x1.5	 M22F8UHA8UB	8	10.5	27	27	36	0.096

Air Brake Adaptors and Accessories

WGG88B

Bulkhead Union, Female Metric Thread

Brass, NBR

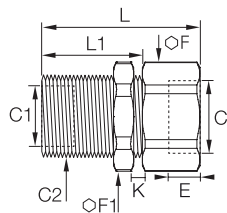

C	C1	C2		E	F	F1	K _{max}	L	L1	Kg
M16x1.5	M16x1.5	M22x1.5	M16WGG88BH27	10	27	27	16	30	23	0.082
M22x1.5	M16x1.5	M26x1.5	M22M16WGG88B	12	30	32	10	32	18	0.128

WG8F8UB

Bulkhead Union, Male/Female Metric Thread

Brass, NBR

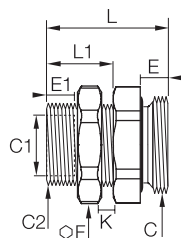

C	C1	C2		E	E1	F	K _{max}	L	L1	Kg
M16x1.5	M16x1.5	M22x1.5	M16WG8F8UB	8	10	27	10	32	17	0.086
M22x1.5	M16x1.5	M22x1.5	M16M22WG8F8UB	8	10	27	10	32	17	0.080

PPRF8UM

Stud Test Point, Male Metric Thread

Brass, NBR

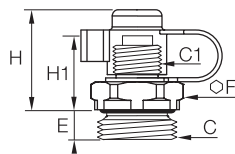

C	C1		E	F	H	H1	Kg
M16x1.5	M16x1.5	PPRF8UM16	9.5	22	34.5	31.5	0.057
M22x1.5	M16x1.5	PPRF8UM22	9.5	27	34.5	31.5	0.072

PPRC8UM

Test Point 90° Elbow, Male Metric Thread

Brass, NBR

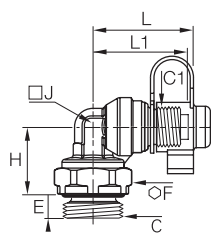

C	C1		E	F	H	J	L	L1	kg
M22x1.5	M16x1.5	PPRC8UM22	10.5	27	18	19	39	36	0.142

The body can be locked in the desired orientation with the locknut.

PPRV8UM

Test Point 45° Elbow, Male Metric Thread

Brass, NBR

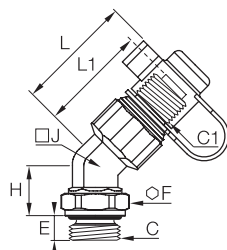

C	C1		E	F	H	J	L	L1	kg
M22x1.5	M16x1.5	PPRV8UM22	10.5	27	32	14	38	35	0.119

The body can be locked in the desired orientation with the locknut.

Air Brake Adaptors and Accessories

VDPF8UM

Drain Valve, Male Metric Thread

Brass, NBR

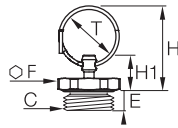

C		E	F	H	H1	ØT	Kg
M22x1.5	VDPF8UM22L13	7.5	27	47.5	24	26	0.037

P8UNBL

Plug, Male Metric Thread

Brass, NBR

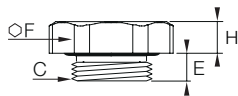

C		E	F	H	Kg
M12x1.5	M12P8UNBL	7.5	17	4.5	0.013
M14x1.5	M14P8UNBL	7.5	17	4.5	0.016
M16x1.5	M16P8UNBL	8	22	5	0.022
M22x1.5	M22P8UNBL13	7.5	27	5	0.038

3126

Blanking Plug

Technical polymer

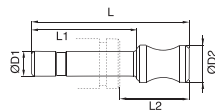

ØD		G	L	L1	Kg
6	3126 06 00	8	33	16,5	0,001
8	3126 08 00	10	35	17,5	0,001
10	3126 10 00	12	42	21	0,002
12	3126 12 00	14	45	22	0,003

WLNB

Bulkhead Locknut

Brass

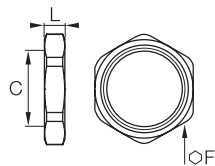

C		F	L	Kg
M16x1.5	WL8NBM16X1.5	22	5	0.010
M18x1.5	WL8NBM18X1.5	22	5	0.008
M20x1.5	WL8NBM20X1.5	24	5	0.008
M22x1.5	WL8NBM22X1.5	27	6	0.014
M24x1.5	WL8NBM24X1.5	30	7	0.019

LF 3600 Push-In Fittings Range

Stud Fittings

Straights

- 3675**
BSPT
Page 1-97
- 3601**
BSPP/Metric
Page 1-97
- 3681**
Metric
Page 1-97
- 3614**
BSPP/Metric
Page 1-98
- 3621**
BSPT
Page 1-98
- 3631**
BSPP/Metric
Page 1-98
- 3600**
Page 1-98



Elbows

- 3609**
BSPT
Page 1-99
- 3629**
BSPT
Page 1-99
- 3699**
BSPP/Metric
Page 1-99
- 3669**
BSPP/Metric
Page 1-100



Tees

- 3608**
BSPT
Page 1-100
- 3603**
BSPT
Page 1-100
- 3698**
BSPP/Metric
Page 1-100
- 3693**
BSPP/Metric
Page 1-101



Banjo

- 3618**
BSPP/Metric
Page 1-101



Tube-to-Tube Fittings

Straight

- 3606**
Page 1-102



Elbow

- 3602**
Page 1-102



Tee

- 3604**
Page 1-102



Bulkhead Connector Fittings

Straights

- 3616**
BSPT
Page 1-103
- 3636**
BSPP
Page 1-103



Elbow

- 3639**
Page 1-103



Plug-In Accessories

- 3666**
Page 1-104
- 3667**
Page 1-104
- 3668**
Page 1-104
- 3622**
Page 1-104
- 3620**
Page 1-104
- 3626**
Page 1-105



Accessories

- 0605**
Page 1-105
- 3000 70**
Page 1-105
- 3610**
Page 1-105



LF 3600 Push-In Fittings

In order to meet your **technical and environment requirements**, Parker Legris designed this range of metal fittings, offering **robustness, reliability** and **resistance to industrial fluids** for the most demanding environments.

Product Advantages

- High Performance**
 - Resistant up to +150°C at 30 bar
 - Excellent mechanical performance
 - Long threads to resist shock and vibration
 - Excellent abrasion and corrosion resistance due to high phosphorus chemical nickel plating
 - Full flow, minimal pressure drop
- Versatility**
 - Materials conform to FDA standards
 - Spring collet gripping system suitable for both metal (grooved) and polymer tubing
 - Excellent resistance to high pressure and vacuum
 - Excellent chemical compatibility
 - More than 250 part numbers
 - One fitting for numerous applications: stock optimisation
 - Manual connection and disconnection
 - Compact and ergonomic
- Reliability**
 - High performance brass for increased lifespan
 - 100% leak-tested in production
 - Date coding to guarantee quality and traceability



Food Process
Coffee Machines
In-Plant Automotive
Medical Equipment
Printing
Misting
Welding Robots

Applications

Technical Characteristics

Suitable Fluids	Compressed air, grease, lubricant, water...
Working Pressure	Vacuum to 30 bar (20 bar: 3699, 3609)
Working Temperature	-25°C to +150°C

Maximum Tightening Torque (daN.m)	Thread							
	M5 x0.8	M6 x1	M8 x1	M10 x1	G1/8	G1/4	G3/8	G1/2
	0.16	0.18	0.6	0.8	0.8	1.2	3	3.5

Reliable performance is dependent upon the type of fluid conveyed, component materials and tubing being used.
Use is guaranteed with a vacuum of 755 mm Hg (99% vacuum).

Component Materials

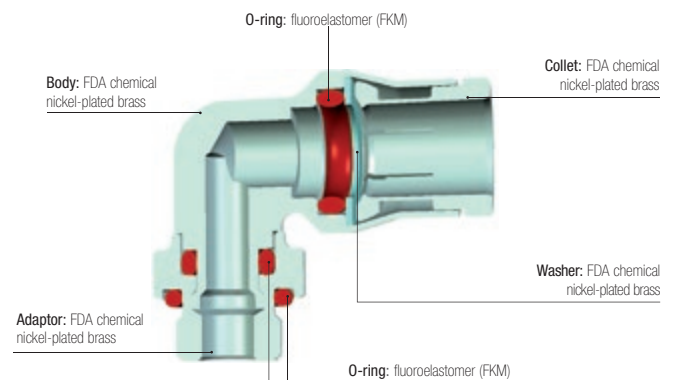

Silicone-free

Regulations

Industrial
ISO 14743: pneumatic transmissions, push-in fittings for thermoplastic tubing
DI: 97/23/EC (PED)
DI: 2002/95/EC (RoHS), 2011/65/EC
RG: 1907/2006 (REACH)
DI: 94/9/EC (ATEX)
UL94 V-0: please consult us

Food
RG: 21CFR (FDA)
RG: 1935/2004/EC (minimum flow 0.02 l/h)
USDA NSF H1: grease
ASTM B733-04: autocatalytic (electroless) nickel-phosphorus coatings

Stud Fittings

3675 Stud Fitting, Male BSPT Thread



FDA chemical nickel-plated brass, FKM

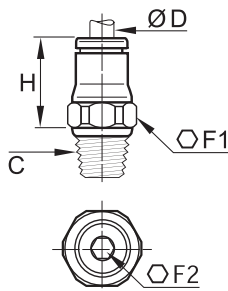

ØD	C		F1	F2	H	kg
4	R1/8	3675 04 10	10	3	15	0.009
	R1/4	3675 04 13	14	3	15	0.017
6	R1/8	3675 06 10	13	4	17	0.011
	R1/4	3675 06 13	14	4	17	0.018
8	R1/8	3675 08 10	15	5	19	0.015
	R1/4	3675 08 13	16	6	18	0.019
10	R3/8	3675 08 17	17	6	18.5	0.027
	R1/4	3675 10 13	18	7	23	0.026
	R3/8	3675 10 17	18	8	22.5	0.031
12	R1/2	3675 10 21	22	8	22.5	0.056
	R1/4	3675 12 13	20	7	25.5	0.033
	R3/8	3675 12 17	20	9	24	0.035
14	R1/2	3675 12 21	22	10	23	0.051
	R3/8	3675 14 17	22	9	27	0.042
	R1/2	3675 14 21	24	11	26	0.057

3601 Stud Fitting, Male BSPP and Metric Thread



FDA chemical nickel-plated brass, FKM

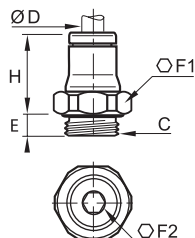

ØD	C		E	F1	F2	H	kg
4	M5x0.8	3601 04 19	3.5	10	2.5	15.5	0.006
	M6x1	3601 04 52	4.5	10	3	16	0.006
	M8x1	3601 04 56	5	11	3	14.5	0.007
	G1/8	3601 04 10	5.5	13	3	14.5	0.009
6	G1/4	3601 04 13	6.5	16	3	14.5	0.015
	M5x0.8	3601 06 19	3.5	13	2.5	19	0.010
	M10x1	3601 06 60	5.5	13	4	17.5	0.011
	G1/8	3601 06 10	5.5	13	4	17.5	0.011
8	G1/4	3601 06 13	6.5	16	4	17	0.015
	G1/8	3601 08 10	5.5	16	5	21	0.014
	G1/4	3601 08 13	6.5	16	6	18	0.016
	G3/8	3601 08 17	7.5	20	6	19	0.028
10	G1/4	3601 10 13	6.5	18	7	25	0.025
	G3/8	3601 10 17	7.5	20	8	22.5	0.028
	G1/2	3601 10 21	9	24	8	22.5	0.043
	G1/4	3601 12 13	6.5	20	7	26.5	0.030
12	G3/8	3601 12 17	7.5	20	9	26	0.034
	G1/2	3601 12 21	9	24	10	23.5	0.042
14	G3/8	3601 14 17	7.5	22	9	28	0.038
	G1/2	3601 14 21	9	24	11	26.5	0.045

3681 Stud Fitting with Internal Hexagon, Male Metric Thread



FDA chemical nickel-plated brass, FKM

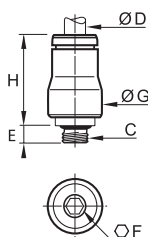

ØD	C		E	F	G	H	kg
4	M5x0.8	3681 04 19	3.5	2.5	10	16	0.005

Related Products

- Polyurethane Tubing
- Polyamide Tubing
- Polyethylene Tubing
- Fluoropolymer Tubing
- Anti-Spark Tubing
- Fireproof PA Tubing
- Brass Flow Control Regulators

Stud Fittings

3614 Stud Fitting, Female BSPP and Metric Thread



FDA chemical nickel-plated brass, FKM

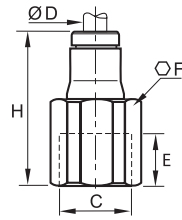

ØD	C		E	F	H	kg
4	M5x0.8	3614 04 19	5	10	22	0.009
	G1/8	3614 04 10	7.5	14	25	0.016
	G1/4	3614 04 13	11	17	29	0.026
6	G1/8	3614 06 10	7.5	14	27.5	0.019
	G1/4	3614 06 13	11	17	31.5	0.028
8	G1/8	3614 08 10	9.5	15	28.5	0.022
	G1/4	3614 08 13	13.5	17	32.5	0.028
10	G3/8	3614 10 17	14	22	38	0.052
12	G3/8	3614 12 17	14	22	39	0.055
	G1/2	3614 12 21	18.5	24	43.5	0.062

3621 Stud Standpipe, Male BSPT Thread



FDA chemical nickel-plated brass

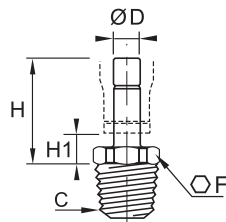

ØD	C		F	H	H1	kg
4	R1/8	3621 04 10	10	21	7	0.006
	R1/4	3621 04 13	14	21	7	0.014
6	R1/8	3621 06 10	10	23.5	6.5	0.008
	R1/4	3621 06 13	14	23.5	6.5	0.016
8	R1/8	3621 08 10	10	24	6.5	0.009
	R1/4	3621 08 13	14	24	6.5	0.017
10	R1/4	3621 10 13	14	22	6.5	0.018
	R3/8	3621 10 17	17	30	7.5	0.022
12	R3/8	3621 12 17	17	31	7.5	0.023
	R1/2	3621 12 21	22	31	7.5	0.041
14	R1/2	3621 14 21	22	33	8	0.042

3631 Stud Standpipe, Male BSPP and Metric Thread



FDA chemical nickel-plated brass, FKM

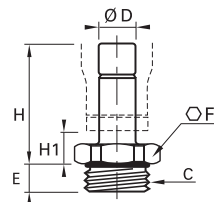

ØD	C		E	F	H	H1	kg
4	M5x0.8	3631 04 19	3.5	13	21.5	7	0.003
	G1/8	3631 04 10	5.5	13	20	7	0.007
	G1/4	3631 04 13	6.5	8	20	7.5	0.011
6	G1/8	3631 06 10	5.5	13	22.5	6.5	0.009
	G1/4	3631 06 13	6.5	16	22.5	6.5	0.012
8	G1/8	3631 08 10	5.5	13	22.5	6.5	0.010
	G1/4	3631 08 13	6.5	16	23	6.5	0.013
	G3/8	3631 08 17	7.5	20	23	7.5	0.018
10	G1/4	3631 10 13	6.5	16	28	6.5	0.015
	G3/8	3631 10 17	7.5	20	28	7.5	0.022
	G1/2	3631 10 21	9	24	28	7.5	0.028
12	G3/8	3631 12 17	7.5	20	29	7.5	0.023
	G1/2	3631 12 21	9	24	29	7.5	0.033
14	G1/2	3631 14 21	9	24	31	8	0.033

3600 One-Piece Cartridge



FDA chemical nickel-plated brass, FKM

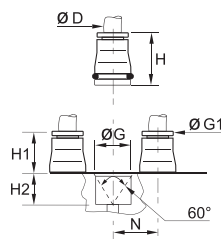

ØD		G	G1	H	H1	H2	N	kg
4	3600 04 00	9.8	8	17	8.5	8.5	11	0.006
6	3600 06 00	12.1	10	19	10.5	8.5	13.5	0.009
8	3600 08 00	14.8	13	21	12.5	8.5	16	0.012
10	3600 10 00	17.5	15	24.5	14	10.5	20	0.019
12	3600 12 00	20	17	25	14.5	10.5	22.5	0.023
14	3600 14 00	22	20	28.5	16.5	12	25	0.031

Stud Fittings

3609 Stud Elbow, Male BSPT Thread



FDA chemical nickel-plated brass, FKM

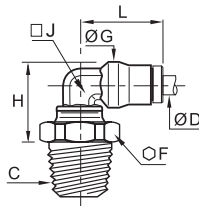

ØD	C		F	G	H	J	L	kg
4	R1/8	3609 04 10	13	10	15	7	18	0.014
	R1/4	3609 04 13	14	10	17	7	18	0.020
6	R1/8	3609 06 10	13	12	17.5	8	21.5	0.018
	R1/4	3609 06 13	14	12	19	8	21.5	0.025
8	R1/8	3609 08 10	13	15	19.5	10	23.5	0.023
	R1/4	3609 08 13	14	15	21	10	23.5	0.029
	R3/8	3609 08 17	17	15	21	10	23.5	0.035
10	R1/4	3609 10 13	15	17.5	23.5	12	29	0.037
	R3/8	3609 10 17	17	17.5	25.5	12	29	0.043
12	R1/4	3609 12 13	15	19.5	26	15	31	0.049
	R3/8	3609 12 17	17	19.5	28.5	15	31	0.055
	R1/2	3609 12 21	21	19.5	28.5	15	31	0.072
14	R3/8	3609 14 17	19	21.5	29	16	34	0.063
	R1/2	3609 14 21	22	21.5	30	16	34	0.072

The body swivels for positioning purposes.

3629 Extended Stud Elbow, Male BSPT Thread



FDA chemical nickel-plated brass, FKM

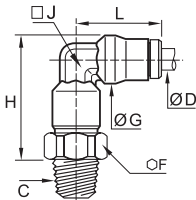

ØD	C		F	G	H	J	L	kg
4	R1/8	3629 04 10	10	10	24.5	7	18	0.025
	R1/8	3629 06 10	13	12	29.5	8	21.5	0.024
6	R1/4	3629 06 13	14	12	30.5	8	21.5	0.031
	R1/8	3629 08 10	14	15	32.5	10	23.5	0.031
8	R1/4	3629 08 13	14	15	34	10	23.5	0.037
	R1/4	3629 10 13	18	17.5	39	12	29	0.054

The body swivels for positioning purposes.

3699 Compact Elbow, Male BSPP and Metric Thread



FDA chemical nickel-plated brass, FKM

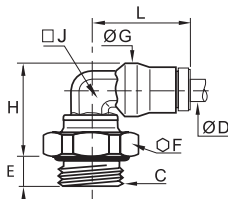

ØD	C		E	F	G	H	J	L	kg
4	M5x0.8	3699 04 19	3.5	10	10	18	7	18	0.011
	M6x1	3699 04 52	4.5	10	10	18	7	18	0.011
	M8x1	3699 04 56	5	11	10	18	7	18	0.013
	G1/8	3699 04 10	5.5	13	10	17	7	18	0.014
	G1/4	3699 04 13	6.5	16	10	17.5	7	18	0.019
6	M10x1	3699 06 60	5.5	13	12	19	8	21.5	0.017
	G1/8	3699 06 10	5.5	13	12	19	8	21.5	0.018
	G1/4	3699 06 13	6.5	16	12	19.5	8	21.5	0.022
8	G1/8	3699 08 10	5.5	13	15	20.5	10	23.5	0.021
	G1/4	3699 08 13	6.5	16	15	21.5	10	23.5	0.027
	G3/8	3699 08 17	7.5	20	15	21.5	10	23.5	0.033
10	G1/4	3699 10 13	6.5	16	17.5	27	12	29	0.037
	G3/8	3699 10 17	7.5	20	17.5	25.5	12	29	0.043
12	G1/4	3699 12 13	6.5	16	19.5	29.5	15	31	0.050
	G3/8	3699 12 17	7.5	20	19.5	28.5	15	31	0.057
14	G1/2	3699 12 21	9	24	19.5	28.5	15	31	0.065
	G3/8	3699 14 17	7.5	20	21.5	29	16	34	0.059
	G1/2	3699 14 21	9	24	21.5	29.5	16	34	0.062

The body swivels for positioning purposes.

Stud Fittings

3669 Extended Stud Elbow, Male BSPP and Metric Thread



FDA chemical nickel-plated brass, FKM

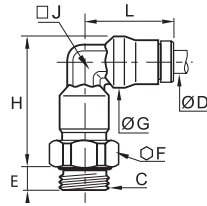

ØD	C		E	F	G	H	J	L	kg
4	M5x0.8	3669 04 19	3.5	10	10	27.5	7	18	0.014
	G1/8	3669 04 10	5.5	13	10	25.5	7	18	0.017
6	G1/8	3669 06 10	5.5	13	12	31	8	21.5	0.024
	G1/4	3669 06 13	6.5	16	12	30.5	8	21.5	0.028
8	G1/8	3669 08 10	5.5	14	15	33.5	10	23.5	0.031
	G1/4	3669 08 13	5.5	16	15	34	10	23.5	0.035
10	G1/4	3669 10 13	6.5	18	17.5	42	12	29	0.052
	G3/8	3669 10 17	7.5	20	17.5	41	12	29	0.056
12	G1/4	3669 12 13	6.5	20	19.5	47	15	31	0.070
	G3/8	3669 12 17	7.5	20	19.5	46	15	31	0.341
14	G1/2	3669 14 21	9	24	21.5	49	16	34	0.094

The body swivels for positioning purposes.

3608 Stud Branch Tee, Male BSPT Thread



FDA chemical nickel-plated brass, FKM

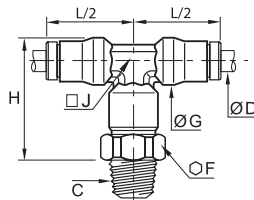

ØD	C		F	G	H	J	L/2	kg
4	R1/8	3608 04 10	10	10	24.5	7	18	0.020
	R1/4	3608 06 13	14	12	30.5	8	21.5	0.038
6	R1/8	3608 06 10	13	12	29.5	8	21.5	0.031
	R1/4	3608 06 13	14	12	30.5	8	21.5	0.038
8	R1/8	3608 08 10	14	15	32.5	10	23.5	0.040
	R1/4	3608 08 13	14	15	34	10	23.5	0.047
10	R1/4	3608 10 13	18	17.5	39	12	29	0.067
	R3/8	3608 10 17	18	17.5	41	12	29	0.070
12	R3/8	3608 12 17	20	19.5	46.5	15	31	0.094
14	R1/2	3608 14 21	22	21.5	50.5	16	34	0.125

The body swivels for positioning purposes.

3603 Stud Run Tee, Male BSPT Thread



FDA chemical nickel-plated brass, FKM

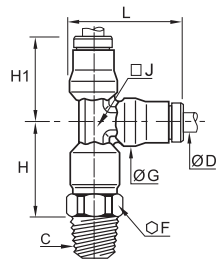

ØD	C		F	G	H	H1	J	L	kg
4	R1/8	3603 04 10	10	10	19.5	18	7	23	0.018
	R1/4	3603 06 13	14	12	24.5	21.5	8	28	0.037
6	R1/8	3603 06 10	13	12	23.5	21.5	8	28	0.031
	R1/4	3603 06 13	14	12	24.5	21.5	8	28	0.037
8	R1/8	3603 08 10	14	15	25	23.5	10	31	0.041
	R1/4	3603 08 13	14	15	26.5	23.5	10	31	0.044
10	R1/4	3603 10 13	18	17.5	30.5	29	12	37.5	0.067
	R3/8	3603 10 17	18	17.5	32.5	29	12	37.5	0.069
12	R3/8	3603 12 17	20	19.5	36.5	31	15	40.5	0.103
14	R1/2	3603 14 21	22	21.5	40	34	16	45	0.147

The body swivels for positioning purposes.

3698 Stud Branch Tee, Male BSPP and Metric Thread



FDA chemical nickel-plated brass, FKM

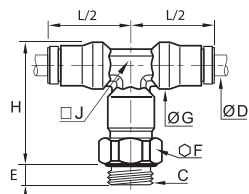

ØD	C		E	F	G	H	J	L/2	kg
4	M5x0.8	3698 04 19	3.5	10	10	27.5	7	18	0.018
	G1/8	3698 04 10	5.5	13	10	25.5	7	18	0.021
6	G1/8	3698 06 10	5.5	13	12	31	8	21.5	0.031
	G1/4	3698 06 13	6.5	16	12	30.5	8	21.5	0.035
8	G1/8	3698 08 10	5.5	14	15	33.5	10	23.5	0.041
	G1/4	3698 08 13	6.5	16	15	34	10	23.5	0.045
10	G1/4	3698 10 13	6.5	18	17.5	42	12	29	0.066
12	G3/8	3698 12 17	7.5	20	19.5	46	15	31	0.088
14	G1/2	3698 14 21	9	24	21.5	49	16	34	0.111

The body swivels for positioning purposes.

Stud Fittings

3693 Stud Run Tee, Male BSPP and Metric Thread



FDA chemical nickel-plated brass, FKM

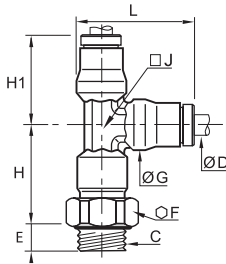

ØD	C		E	F	G	H	H1	J	L	kg
4	M5x0.8	3693 04 19	3.5	10	10	22.5	18	7	23	0.019
	G1/8	3693 04 10	5.5	13	10	20.5	18	7	23	0.021
6	G1/8	3693 06 10	5.5	13	12	25	21.5	8	28	0.031
	G1/4	3693 06 13	6.5	16	12	24.5	21.5	8	28	0.035
8	G1/8	3693 08 10	5.5	14	15	26.5	23.5	10	31	0.041
	G1/4	3693 08 13	6.5	16	15	26.5	23.5	10	31	0.044
10	G1/4	3693 10 13	6.5	18	17.5	33	29	12	37.5	0.066
12	G3/8	3693 12 17	7.5	20	19.5	36.5	31	15	40.5	0.090
14	G1/2	3693 14 21	9	24	21.5	38.5	34	16	45	0.112

The body swivels for positioning purposes.

3618 Single Banjo, Male BSPP and Metric Thread



FKM, FDA chemical nickel-plated brass

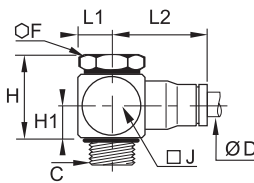

ØD	C		F	H	H1	J	L1	L2	kg
4	M5x0.8	3618 04 19	8	14.5	6.5	10	6	18.5	0.011
	G1/8	3618 04 10	14	23	9.5	17	10	20.5	0.029
6	M5x0.8	3618 06 19	8	15	7	10	6	22.5	0.015
	G1/8	3618 06 10	14	23	9.5	17	10	23.5	0.031
8	G1/4	3618 06 13	17	22	9	22	13	25.5	0.049
	G1/8	3618 08 10	14	23	9.5	17	10	26	0.033
10	G1/4	3618 08 13	17	22	9	22	13	27.5	0.051
	G3/8	3618 10 17	22	33	14	22	13	32	0.105

Maximum temperature: +80°C

Each model has been designed to meet specific requirements: compactness due to small overall dimensions, with inter-connectability for customised configurations.



Tube-to-Tube Fittings

3606 Equal Tube-to-Tube Connector



FDA chemical nickel-plated brass, FKM

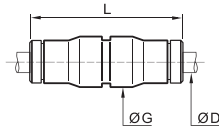

ØD		G	L	kg
4	3606 04 00	10	30.5	0.010
6	3606 06 00	12	36.5	0.016
8	3606 08 00	15	37.5	0.021
10	3606 10 00	17.5	47.5	0.034
12	3606 12 00	19.5	50	0.042
14	3606 14 00	21.5	52.5	0.050

3602 Equal Elbow



FDA chemical nickel-plated brass, FKM

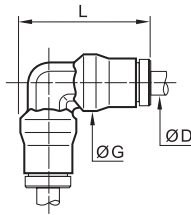

ØD		G	L	kg
4	3602 04 00	10	23	0.010
6	3602 06 00	12	28	0.016
8	3602 08 00	15	31	0.023
10	3602 10 00	17.5	37.5	0.033
12	3602 12 00	19.5	40.5	0.045
14	3602 14 00	21.5	45	0.056

3604 Equal Tee



FDA chemical nickel-plated brass, FKM

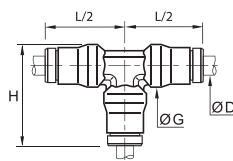

ØD		G	H	L/2	kg
4	3604 04 00	10	23	18	0.014
6	3604 06 00	12	28	21.5	0.023
8	3604 08 00	15	31	23.5	0.032
10	3604 10 00	17.5	37.5	29	0.048
12	3604 12 00	19.5	40.5	31	0.063
14	3604 14 00	21.5	45	34	0.078

Bulkhead Connector Fittings

3616 Equal Bulkhead Connector



FDA chemical nickel-plated brass, FKM

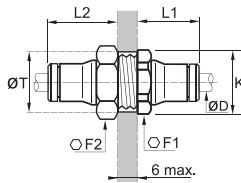

ØD		F1	F2	K	L1	L2	ØT min	kg
4	3616 04 00	13	14	14	14	20	12.5	0.018
6	3616 06 00	16	17	17.5	17	22	15	0.028
8	3616 08 00	18	19	19.5	18.5	23.5	17	0.036
10	3616 10 00	22	27	24	21.5	26.5	21	0.063
12	3616 12 00	24	24	26	23	27	23	0.062
14	3616 14 00	27	27	29.5	25.5	29.5	25	0.079

3636 Bulkhead Connector, Female BSPP Thread



FDA chemical nickel-plated brass, FKM

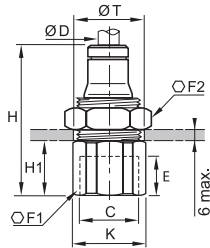

ØD	C		E	F1	F2	H	H1	K	ØT min	kg
4	G1/8	3636 04 10	8.5	14	14	30.5	11	15	13	0.020
	G1/8	3636 06 10	8.5	17	17	33	11	18.5	15	0.033
6	G1/4	3636 06 13	11.5	17	17	37	15	18.5	15	0.033
	G1/8	3636 08 10	8.5	19	19	34	10.5	21	17	0.044
8	G1/4	3636 08 13	11.5	19	19	38	14.5	21	17	0.044
	G3/8	3636 10 17	12	22	27	42.5	16	24	21	0.073
10	G3/8	3636 12 17	12	24	24	43	16	26	23	0.077
	G1/2	3636 12 21	16	27	24	48.5	21.5	29.5	23	0.133

3639 Equal Bulkhead Elbow



FDA chemical nickel-plated brass, FKM

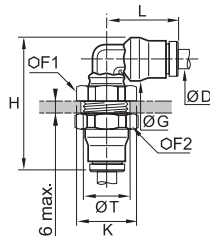

ØD		F1	F2	G	H	K	L	ØT min	kg
4	3639 04 00	13	14	10	35	14	18	12.5	0.023
6	3639 06 00	16	17	12	40.5	17.5	21.5	15	0.035
8	3639 08 00	18	19	15	44	19.5	23.5	17	0.046
10	3639 10 00	22	27	17.5	51	24	29	21	0.080
12	3639 12 00	24	24	19.5	55	26	31	23	0.086
14	3639 14 00	27	27	21.5	59	29.5	34	25	0.144

The body swivels for positioning purposes.

Plug-In Accessories

3666 Plug-In Reducer



FDA chemical nickel-plated brass, FKM

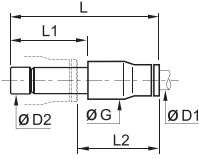

ØD1	ØD2		G	L	L1	L2	kg
4	6	3666 04 06	10	35	19.5	18	0.008
	8	3666 04 08	10	35.5	20	18	0.009
6	8	3666 06 08	12	38	20	20.5	0.012
	10	3666 06 10	12	43.5	25	21	0.015
8	10	3666 08 10	15	44	25	21.5	0.016
	12	3666 08 12	15	44	26	20.5	0.018
10	12	3666 10 12	17.5	50	26	27	0.026
12	14	3666 12 14	19.5	53	28	28.5	0.032

3667 Plug-In Metric/Inch Adaptor



FDA chemical nickel-plated brass, FKM

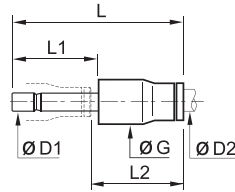

ØD1	ØD2		G	L	L1	L2	kg
6	1/4	3667 06 56	12.5	38.5	19.5	21	0.012
10	3/8	3667 10 60	17	49.5	25	27	0.026
12	1/2	3667 12 62	20	51	26	27.5	0.030

3668 Plug-In Increaser



FDA chemical nickel-plated brass, FKM

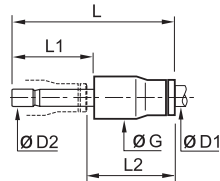

ØD1	ØD2		G	L	L1	L2	kg
6	4	3668 06 04	12	36	17	21.5	0.010

3622 Plug-In Barb Connector



FDA chemical nickel-plated brass

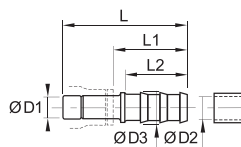

ØD1	ØD2		ØD3	L	L1	L2	kg
4	3.2	3622 04 53	5	40.5	27	22.5	0.003
	5	3622 04 05	7	40.5	27	22.5	0.005
6	5	3622 06 05	7	43	27	22.5	0.006
	6.3	3622 08 56	8.3	42	25	22.5	0.008
8	8	3622 08 08	10	44	27	22.5	0.010
	6.3	3622 10 56	8.3	47.5	25.5	22.5	0.011
10	8	3622 10 08	10	47.5	25.5	22.5	0.011
	8	3622 12 08	10	48.5	25.5	22.5	0.015
12	10	3622 12 10	10	48.5	25.5	22.5	0.014
	12.5	3622 12 62	14.5	57	34	29.5	0.019
14	12.5	3622 14 62	16	57.5	33	29.5	0.022
	14	3622 14 14	16	59.5	35	29.5	0.023

3620 Male Stem Connector



FDA chemical nickel-plated brass

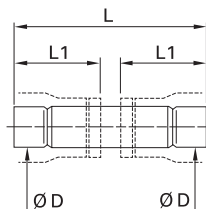

ØD		L	L1	kg
4	3620 04 00	31	14	0.002
6	3620 06 00	36.5	17	0.005
8	3620 08 00	37.5	17.5	0.007
10	3620 10 00	47.5	22.5	0.011
12	3620 12 00	49.5	23.5	0.015
14	3620 14 00	53	25	0.016

Accessories

3626 Blanking Plug



FDA chemical nickel-plated brass

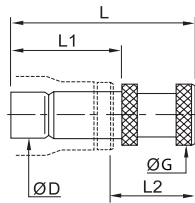

ØD		G	L	L1	L2	kg
4	3626 04 00	6	25.5	17.5	11.5	0.004
6	3626 06 00	8	30.5	19.5	13.5	0.009
8	3626 08 00	10	33	20	16	0.009
10	3626 10 00	12	40	25	18	0.015
12	3626 12 00	14	43	26	20	0.021
14	3626 14 00	16	47	28	22.5	0.029

0605 Fluoropolymer Tape

FKM



kg



[0605 12 12](#)

0.012

Can be used for temperatures from - 250°C to +260°C.

Chemically inert and resistant to gases, acids, solvents, hydrocarbons, oils, alkalines, steam etc.

Non-toxic, waterproof, self-lubricating.

In accordance with CFR21.

Can be used on all materials.

Used to facilitate the preparation of leak-free threaded joints.

Supplied on a reel, length = 12 m, width = 12.7 mm, thickness 0.08 mm.

3000 70 Dismounting Tool

Treated steel



H H1 L kg

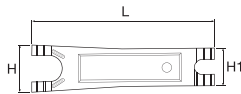

[3000 70 00](#)

25 20 96 0.021

For dismounting LF 3000® tubing/fittings where access is difficult, we recommend the use of this dismounting tool.

3610 Coloured Release Button Covers

Anodised aluminium

ØD



kg



6	3610 06 00	3610 06 04	0.004
8	3610 08 00	3610 08 04	0.007
10	3610 10 00	3610 10 04	0.011
12	3610 12 00	3610 12 04	0.013
14	3610 14 00	3610 14 04	0.016

Red and green colours are available upon request.

Coloured release buttons covers help the identification of circuits and will protect your connections against spark projections.

LF 6100 Push-In Fittings Range

Stud Fittings

Straights

6105

BSPT/Metric Taper
Page 1-109



6101

Metric Parallel
Page 1-109



6114

Metric Parallel
Page 1-109



Elbow

6179

BSPT Metric Taper
Page 1-109



Tube-to-Tube Fittings

Straight

6106

Page 1-110



Tee

6104

Page 110



Accessory

0138

Page 1-110



LF 6100 Push-In Fittings

This fittings range dedicated to **lubrication and vacuum systems**, combines very high performance and manual connection. This technology **secures the connection** and sealing performance, even at high pressure.

Product Advantages

Robust | Designed for mechanically demanding environments
Excellent pressure and temperature resistance
Stamped brass forgings for increased service life

Secure & Reliable | Perfect sealing guaranteed by the three rings
The two sealing O-rings positioned before the gripping ring endure no scratching on the tube in the sealing area
Manual connection for time-saving
No fluid loss
Tube cannot be disconnected without the use of a spanner
Up to 60 bar with rigid polymer or grooved metal tubing
100% leak-tested in production



Construction Equipment
Lubrication
Transportation
Measurement Systems
Industrial Machines
Industrial Vacuum

Applications

Technical Characteristics

Compatible Fluids	Lubricants, compressed air, vacuum, other fluids and compatible gases
Working Pressure	Vacuum to 60 bar
Working Temperature	-40° to +120°C

Max./Min. Tightening Torques (daN.m)	Thread	M6 x1	M8 x1	M8 x1.25	M10 x1	M12 x1	M14 x1.5	R 1/8	R 1/4
	Taper	0.2/0.6	0.2/1.2	0.2/1	0.2/1.2	0.2/2	0.5/1.5	0.2/1.0	0.5/1.5
	Parallel	-	0.6/1	-	0.6/1	1.8/2.2	-	-	-

Reliable performance is dependent upon the type of fluid conveyed, component materials and tubing being used.
Use is guaranteed with a vacuum of 755 mm Hg (99% vacuum).

Component Materials

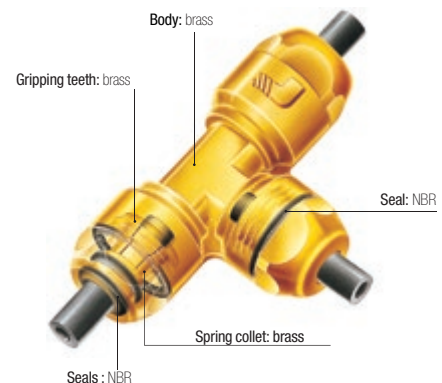

Silicone-free

Regulations

DI: 97/23/EC (PED)
DI: 2002/95/EC (RoHS),
2011/65/EC

DI: 94/9/EC (ATEX)
RG: 1907/2006 (REACH)

Performance

Working Pressure/Temperature According to the Tubing Used

O.D. of Tube	-20°C to +20°C		+20°C to +30°C		+30°C to +50°C		+50°C to +80°C		+80°C to +120°C
	Semi-Rigid PA	Rigid PA	Semi-Rigid PA	Rigid PA	Semi-Rigid PA	Rigid PA	Semi-Rigid PA	Rigid PA	FEP
2x4	40	-	33	-	25.5	-	19	-	-
2.5x4	-	52	-	43	-	32	-	24.5	7
2.7x4	23	-	19	-	15	-	11	-	-
4x6	24	45	20	37	15.5	29	11	21	6
5x8	-	52	-	43	-	33	-	24	-
6x8	17	32	14	27	11	21	8	15	4
6x10	-	57	-	47	-	37	-	27	-
7.5x10	17	-	14	-	11	-	8	-	-
8x10	14	-	12	-	9	-	7	-	3

Stud Fittings

6105 Stud Fitting, Male BSPT and Taper Metric Thread

Brass, NBR

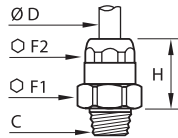

ØD	C		F1	F2	H	kg
4	M6x1	6105 04 52	13	11	16.5	0.013
	M8x1	6105 04 56	13	11	14.5	0.012
	M8x1.25	6105 04 57	13	11	14.5	0.012
	M10x1	6105 04 60	13	11	14.5	0.014
	R1/8	6105 04 10	13	11	14.5	0.014
6	R1/4	6105 04 13	14	11	12.5	0.018
	M10x1	6105 06 60	17	14	16.5	0.024
	R1/8	6105 06 10	17	14	17.5	0.026
8	M14x1.5	6105 06 71	17	14	16.5	0.029
	R1/4	6105 06 13	17	14	16.5	0.029
8	M12x1	6105 08 65	19	21	24	0.041
10	M14x1.5	6105 10 71	22	24	26	0.005

6101 Stud Fitting, Male Parallel and Metric Thread

Brass, NBR

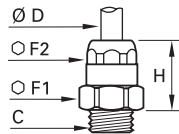

ØD	C		F1	F2	H	kg
4	M10x1	6101 04 60	13	11	14	0.014
6	M10x1	6101 06 60	17	14	17.5	0.026
	M12x1	6101 06 65	17	14	16.5	0.025

6114 Stud Fitting, Female Metric Parallel Thread

Brass, NBR

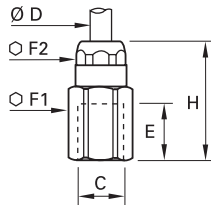

ØD	C		E	F1	F2	H	kg
4	M8x1	6114 04 56	8	13	11	25.5	0.021
6	M8x1	6114 06 56	8	17	14	28.5	0.043

6179 Stud Elbow, Male BSPT and Taper Metric Thread

Brass, NBR

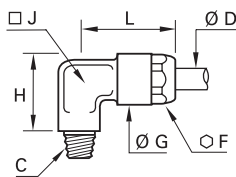

ØD	C		F	G	H	J	L	kg
4	M6x1	6179 04 52	11	12.5	14.5	6	20	0.014
	M8x1	6179 04 56	11	12.5	15	6	20	0.015
	M8x1.25	6179 04 57	11	12.5	15	6	20	0.014
	M10x1	6179 04 60	11	12.5	15.5	6	20	0.016
	R1/8	6179 04 10	11	12.5	15.5	6	20	0.016
6	R1/4	6179 04 13	11	12.5	17	6	20	0.023
	M10x1	6179 06 60	14	16	18	8	25.5	0.029
	M12x1	6179 06 65	14	16	18	8	25.5	0.030
8	R1/8	6179 06 10	14	16	18	8	25.5	0.030
	R1/4	6179 06 13	14	16	19	8	25.5	0.036
8	M12x1	6179 08 65	17	19	21	10	30	0.047

Tube-to-Tube Fittings

6106 Tube-to-Tube Connector

Brass, NBR

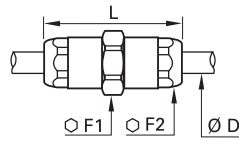

ØD		F1	F2	L	kg
4	6106 04 00	13	11	34	0.025
6	6106 06 00	17	14	39	0.044
8	6106 08 00	19	17	46	0.069

6104 Equal Tee

Brass, NBR

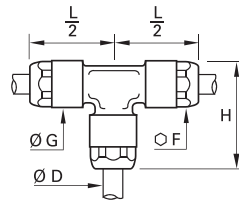

ØD		F	G	H	L/2	kg
4	6104 04 00	11	12.5	26.5	20	0.032
6	6104 06 00	14	16	32.5	25.5	0.066
8	6104 08 00	17	19	38	30	0.103

0138 Copper Washer

Copper

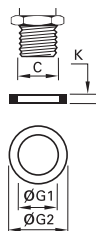

C		G1	G2	K	kg
M8	0138 08 00	8.3	11	1	0.001
G1/8	0138 10 00	10.3	13.5	1	0.001
M12	0138 12 00	12.3	15.5	1.3	0.001

DIN 7603
ISO 65061

Related Products

The Parker Legris push-in system for centralised lubrication is designed for use with various polymer tubing found in Chapter 3, "Technical Tubing and Hose":

- Fireproof High Resistance Polyamide Tubing
- Rigid and Semi-Rigid Calibrated Polyamide Tubing
- Fluoropolymer Tubing





LF 3600/LF 6100

LF 3800/LF 3900 Push-In Fittings Range

Stud Fittings

Straights

3805
3905
BSPT
Page 1-115



3805
NPT
Page 1-115



3801
3901
BSPP/Metric
Page 1-115



3821
3921
BSPT
Page 1-116



3821
3921
NPT
Page 1-116



3831
3931
BSPP/Metric
Page 1-116



3800
3900
Page 1-117



Straights - Inch

3805
NPT
Page 1-115



3821
NPT
Page 1-116



Elbows

3809
3909
BSPT
Page 1-117



3809
NPT
Page 1-117



3899
3999
BSPP/Metric
Page 1-117



3889
3989
BSPT
Page 1-118



3889
NPT
Page 1-118



3879
3979
BSPP
Page 1-118



3889
NPT
Page 1-118



Elbow - Inch

Tees

3803
3903
BSPT
Page 1-119



3803
NPT
Page 1-119



3893
3993
BSPP/Metric
Page 1-119



3808
3908
BSPT
Page 1-119



3808
NPT
Page 1-120



3898
3998
BSPP/Metric
Page 1-120



Tube-to-Tube Fittings

Straight

3806
3906
Page 1-121



Straight - Inch

3806
3906
Page 1-121



Elbow

3802
3902
Page 1-121



Elbow - Inch

3802
3902
Page 1-121



Tee

3804
3904
Page 1-121



Tee - Inch

3804
Page 1-122



Bulkhead Connector Fittings

Straight

3816
3916
Page 1-122



Straight - Inch

3816
3916
Page 1-122



Plug-In Fittings and Accessories

3866
3966
Reducer
Page 1-123



3826
Plug
Page 1-123



Accessories

3800 70
Page 1-123



0605
Page 1-123



3000 70
Page 1-123



LF 3800/LF 3900 Push-In Fittings

Parker Legris has developed two ranges of **stainless steel fittings (LF 3800 or LF 3900 in full 316L)** for conveying corrosive fluids in **aggressive environments**. These ranges provide two complementary levels of corrosion resistance and a **hygienic external design**.

Product Advantages

High Resistance to Aggressive Environments

LF 3800: excellent for conveying aggressive fluids
 LF 3900: maximum chemical resistance to internal and external corrosion
 Hygienic external design for reducing retention zones
 Easy cleaning in situ
 Proven gripping technology

Wide Range of Applications

Perfect for permanent contact with foodstuffs
 Compatible with frequent sterilization
 Excellent in saline environments and outdoor applications
 Resistant to industrial cleaning agents and detergents
 Compatible with polymer and grooved stainless steel tubing
 One fitting for many applications: optimised stock management

Reliability & Safety

All-metal product allowing detection of all components
 Full bore, with minimal pressure drop
 Resistant to hammering, mechanical shock and impulse
 Manual connection and disconnection, no tools required
 100% leak-tested in production
 Date coding to guarantee quality and traceability
 IP 51 bulkhead: complete protection against ingress in food and non-food zones



Applications

Food Process
 Paper Industry
 Petrochemical
 Pharmaceutical
 Chemical
 Medical

Technical Characteristics

Compatible Fluids	All fluids compatible with the fitting and tubing component materials					
Working Pressure	Vacuum to 30 bar (20 bar: 3879/3979 and 3889/3989)					
Working Temperature	-25° to +150°C					

Adaptor Tightening Torque	Threads	M5x0.8	G1/8	G1/4	G3/8	G1/2
	daN.m	0.16	0.8	1.2	3	3.5
Bulkhead Tightening Torque	Ø (mm)	4	6	8	10	12
	daN.m min. max.	0.5 0.9	0.5 0.9	0.6 1	0.6 1	0.6 1

Reliable performance is dependent upon the type of fluid conveyed, component materials and tubing being used.
 Use is guaranteed with a vacuum of 755 mm Hg (99% vacuum).
 Technical performance tested at -25°C according to the ISO 14743 standard.

Component Materials

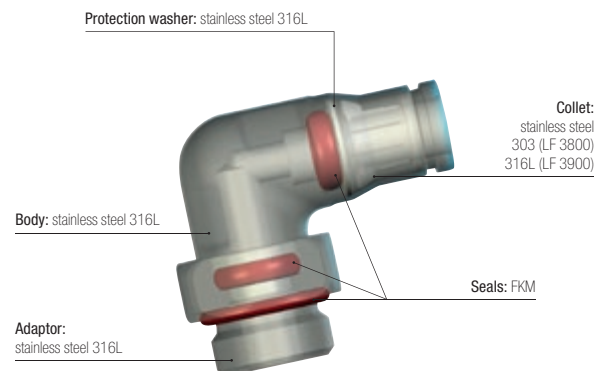

Silicone-free

Regulations

ISO 14743 Pneumatic transmissions, push-in fittings for thermoplastic tubing
 EN 45545-2 HL3, R22, R24, R25 classification can be attained when used with fireproof tubing
 DI: 97/23/EC (PED)
 DI: 2002/95/EC (RoHS), 2011/65/EC

DI: 94/9/EC (ATEX)
 RG: 1907/2006 (REACH)
 UL94 V-0: Seal
 RG: 21CFR (FDA)
 RG: 1935/2004/EC
 USDA NSF H1: Grease

Stud Fittings

3805/3905 Stud Fitting, Male BSPT Thread



Stainless steel 316L, FKM

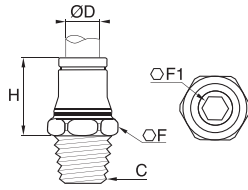

ØD	C			F	F1	H	Kg
4	R1/8	3805 04 10	3905 04 10	10	3	14.5	0.008
	R1/4	3805 04 13	3905 04 13	14	3	14.5	0.016
6	R1/8	3805 06 10	3905 06 10	13	4	18	0.012
	R1/4	3805 06 13	3905 06 13	14	4	16.5	0.018
8	R1/8	3805 08 10	3905 08 10	15	5	19	0.014
	R1/4	3805 08 13	3905 08 13	15	6	18	0.018
10	R3/8	3805 08 17	3905 08 17	17	6	18.5	0.025
	R1/4	3805 10 13	3905 10 13	19	6	24	0.029
	R3/8	3805 10 17	3905 10 17	19	6	22.5	0.030
	R1/4	3805 12 13	3905 12 13	22	7	25	0.034
12	R3/8	3805 12 17	3905 12 17	22	8	24	0.038
	R1/2	3805 12 21	3905 12 21	22	10	23	0.046

3805 Stud Fitting, Male NPT Thread



Stainless steel 316L, FKM

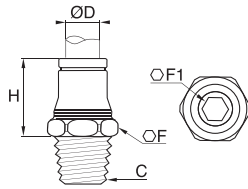

ØD	C		F	F1	H	Kg
4	NPT1/8	3805 04 11	11	3	14.5	0.009
6	NPT1/8	3805 06 11	13	4	18	0.012
	NPT1/4	3805 06 14	14	4	16.5	0.017
8	NPT1/8	3805 08 11	15	5	19	0.015
	NPT1/4	3805 08 14	15	6	18	0.018
10	NPT1/4	3805 10 14	19	6	24	0.028
	NPT3/8	3805 10 18	19	7	22.5	0.031
	NPT1/4	3805 12 14	22	7	25	0.035
12	NPT3/8	3805 12 18	22	8	24	0.039
	NPT1/2	3805 12 22	22	10	23	0.045

3805 Stud Fitting, Male NPT Thread



Inch

Stainless steel 316L, FKM

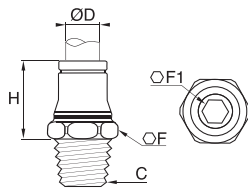

ØD	C		F	F1	H	Kg
3/16	NPT1/8	3805 55 11	10	3	15.5	0.011
	NPT1/4	3805 55 14	14	3	15.5	0.016
1/4	NPT1/8	3805 56 11	13	4	19	0.012
	NPT1/4	3805 56 14	14	4	17.5	0.018
3/8	NPT1/4	3805 60 14	19	6	25	0.029
	NPT3/8	3805 60 18	19	7	24	0.032
1/2	NPT1/4	3805 62 14	22	7	26	0.036
	NPT3/8	3805 62 18	22	8	25	0.041
1/2	NPT1/2	3805 62 22	22	10	25	0.050

5/32" (4 mm) and 5/16" (8 mm) also available

3801/3901 Stud Fitting, Male BSPP and Metric Thread



Stainless steel 316L, FKM

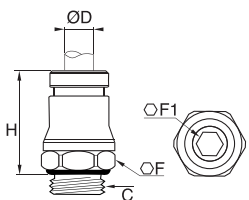

ØD	C			F	F1	H	Kg
4	M5x0.8	3801 04 19	3901 04 19	10	2.5	17	0.005
	G1/8	3801 04 10	3901 04 10	13	3	16.5	0.009
	M5x0.8	3801 06 19	3901 06 19	13	2.5	20.5	0.010
6	G1/8	3801 06 10	3901 06 10	13	4	18	0.010
	G1/4	3801 06 13	3901 06 13	17	4	18	0.015
	G1/8	3801 08 10	3901 08 10	15	5	19	0.013
8	G1/4	3801 08 13	3901 08 13	17	5	20.5	0.017
	G3/8	3801 08 17	3901 08 17	21	6	20	0.027
10	G1/4	3801 10 13	3901 10 13	19	7	25	0.025
	G3/8	3801 10 17	3901 10 17	21	7	25	0.035
12	G1/4	3801 12 13	3901 12 13	21	7	27	0.030
	G3/8	3801 12 17	3901 12 17	21	9	26.5	0.034

Other products are available upon request; please do not hesitate to consult us.

Stud Fittings

3821/3921 Stud Standpipe, Male BSPT Thread



Stainless steel 316L

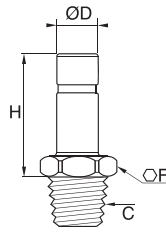

ØD	C			F	H	Kg
4	R1/8	3821 04 10	3921 04 10	10	21	0.006
	R1/4	3821 06 10	3921 06 10	10	23	0.007
6	R1/8	3821 06 13	3921 06 13	14	24	0.015
	R1/4	3821 08 10	3921 08 10	11	24	0.008
8	R1/4	3821 08 13	3921 08 13	14	25	0.016
	R1/4	3821 10 13	3921 10 13	19	30	0.017
10	R3/8	3821 10 17	3921 10 17	19	30	0.022
	R1/4	3821 12 13	3921 12 13	19	31	0.018
12	R3/8	3821 12 17	3921 12 17	19	31	0.022
	R1/2	3821 12 21	3921 12 21	22	32	0.040

3821/3921 Stud Standpipe, Male NPT Thread



Stainless steel 316L

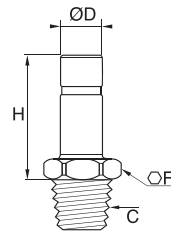

ØD	C			F	H	Kg
4	NPT1/8	3821 04 11	3921 04 11	10	21	0.006
	NPT1/4	3821 06 11	3921 06 11	10	23	0.007
6	NPT1/8	3821 06 14	3921 06 14	14	24	0.016
	NPT1/4	3821 08 11	3921 08 11	14	24	0.010
8	NPT1/4	3821 08 14	3921 08 14	14	25	0.016
	NPT1/4	3821 10 14	3921 10 14	14	30	0.017
10	NPT3/8	3821 10 18	3921 10 18	17	30	0.010
	NPT1/4	3821 12 14	3921 12 14	14	31	0.018
12	NPT3/8	3821 12 18	3921 12 18	17	31	0.026
	NPT1/2	3821 12 22	3921 12 22	22	32	0.050

3821 Stud Standpipe, Male NPT Thread



Inch

Stainless steel 316L

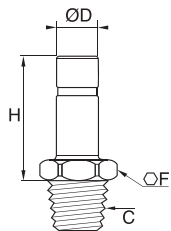

ØD	C		F	H	Kg
3/16	NPT1/8	3821 55 11	10	25	0.009
	NPT1/8	3821 56 11	10	26	0.009
1/4	NPT1/4	3821 56 14	14	27	0.016
	NPT1/4	3821 60 14	19	32	0.019
3/8	NPT3/8	3821 60 18	19	32	0.029
	NPT1/4	3821 62 14	19	36	0.033
1/2	NPT3/8	3821 62 18	19	37	0.025
	NPT1/2	3821 62 22	22	37	0.042

5/32"(4 mm) and 5/16"(8 mm) also available

3831/3931 Stud Standpipe, Male BSPP and Metric Thread



Stainless steel 316L, FKM

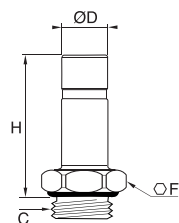

ØD	C			F	H	K	Kg
4	M5x0.8	3831 04 19	3931 04 19	7	23.5	8	0.004
	G1/8	3831 04 10	3931 04 10	13	22	14	0.008
	G1/4	3831 04 13	3931 04 13	17	22	18.5	0.016
6	G1/8	3831 06 10	3931 06 10	13	24	14	0.009
	G1/4	3831 06 13	3931 06 13	17	24	18.5	0.015
	G1/8	3831 08 10	3931 08 10	13	25	14	0.010
8	G1/4	3831 08 13	3931 08 13	17	27	18.5	0.019
	G3/8	3831 08 17	3931 08 17	21	27	23	0.024
	G1/4	3831 10 13	3931 10 13	17	32	18.5	0.020
10	G3/8	3831 10 17	3931 10 17	21	27	23	0.025
	G1/4	3831 12 13	3931 12 13	17	33	18.5	0.021
	G3/8	3831 12 17	3931 12 17	21	33	23	0.028
12	G1/2	3831 12 21	3931 12 21	24	36	26	0.043

LF 3800 : 316L stainless steel (body) with 303 stainless steel collet, FKM seals
 LF 3900 : full 316L, FKM seals

Stud Fittings

3800/3900 One-Piece Cartridge



Stainless steel 316L, FKM

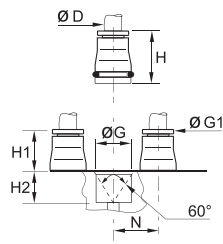

ØD			G	G1	H	H1	H2	N	Kg
4	3800 04 00	3900 04 00	9.8	8	17	8.5	8.5	11	0.006
6	3800 06 00	3900 06 00	12.1	10	19	10.5	8.5	13.5	0.008
8	3800 08 00	3900 08 00	14.8	13	21	12.5	8.5	16	0.012
10	3800 10 00	3900 10 00	17.5	15	24.5	14	10.5	20	0.019
12	3800 12 00	3900 12 00	20	17	25	14.5	10.5	22.5	0.022

3800: collet in stainless steel 303

3900: collet in stainless steel 316L

Cavity dimensions are available in chapter 2.

3809/3909 Stud Elbow, Male BSPT Thread



Stainless steel 316L, FKM

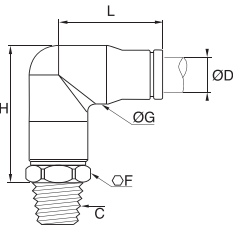

ØD	C			F	G	H	L	Kg
4	R1/8	3809 04 10	3909 04 10	10	10	23.5	16.5	0.020
	R1/8	3809 06 10	3909 06 10	13	12	27.5	20	0.031
6	R1/4	3809 06 13	3909 06 13	14	12	27.5	25	0.036
	R1/8	3809 08 10	3909 08 10	14	15	32	25	0.040
8	R1/4	3809 08 13	3909 08 13	14	14.5	34	25	0.045
	R1/4	3809 10 13	3909 10 13	19	17.5	37.5	27.5	0.069
10	R3/8	3809 10 17	3909 10 17	19	17.5	37.5	27.5	0.070

The body swivels for positioning purposes.

3809 Stud Elbow, Male NPT Thread



Stainless steel 316L, FKM

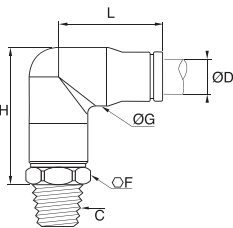

ØD	C			F	G	H	L	Kg
4	NPT1/8	3809 04 11		11	10	25.5	18.5	0.021
	NPT1/8	3809 06 11		13	12.5	29	22.5	0.031
6	NPT1/4	3809 06 14		14	12.5	29	22.5	0.036
	NPT1/8	3809 08 11		14	15	34	24	0.040
8	NPT1/4	3809 08 14		14	15	34	24	0.045
	NPT1/4	3809 10 14		19	17.5	39.5	30	0.068
10	NPT3/8	3809 10 18		19	17.5	39.5	30	0.071

The body swivels for positioning purposes.

3899/3999 Stud Elbow, Male BSPP and Metric Thread



Stainless steel 316L, FKM

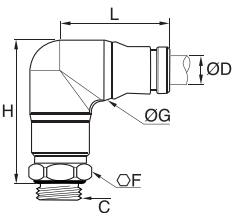

ØD	C			F	G	H	L	Kg
4	M5x0.8	3899 04 19	3999 04 19	10	10	26	18	0.020
	G1/8	3899 04 10	3999 04 10	13	10	27	19	0.022
	G1/4	3899 04 13	3999 04 13	17	10	27	19	0.018
6	M5x0.8	3899 06 19	3999 06 19	13	12	33	24	0.031
	G1/8	3899 06 10	3999 06 10	6	12	33	24	0.031
	G1/4	3899 06 13	3999 06 13	17	12	32	24	0.036
8	G1/8	3899 08 10	3999 08 10	14	15	35	25	0.039
	G1/4	3899 08 13	3999 08 13	17	15	35	25	0.044
	G3/8	3899 08 17	3999 08 17	21	15	34.5	25	0.049
10	G1/4	3899 10 13	3999 10 13	19	17	43	31	0.067
	G3/8	3899 10 17	3999 10 17	21	17	42	31	0.072

The body swivels for positioning purposes.

Stud standpipe 3821, 3921, 3831, 3931 can be used as illustrated, allowing:

- stock optimisation
- installation of tees and elbows where required

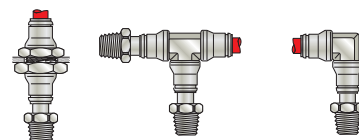

Stud Fittings

3889/3989

Compact Stud Elbow, Male BSPT Thread



Stainless steel 316L, FKM

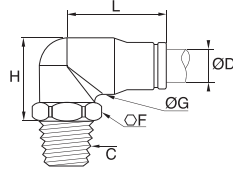

ØD	C			F	G	H	L	Kg
4	R1/8	3889 04 10	3989 04 10	13	10	18	17	0.019
	R1/4	3889 04 13	3989 04 13	17	10	19.5	16.5	0.018
6	R1/8	3889 06 10	3989 06 10	13	12	21.5	20.5	0.026
	R1/4	3889 06 13	3989 06 13	14	12	21.5	20.5	0.032
8	R1/8	3889 08 10	3989 08 10	14	15	24	22	0.035
	R1/4	3889 08 13	3989 08 13	14	15	24	22	0.035
10	R1/4	3889 10 13	3989 10 13	17	17.5	28.5	27.5	0.057
	R3/8	3889 10 17	3989 10 17	19	17.5	28.5	27.5	0.067
12	R1/4	3889 12 13	3989 12 13	22	20	33.5	30	0.088
	R3/8	3889 12 17	3989 12 17	22	20	33.5	30	0.090
	R1/2	3889 12 21	3989 12 21	22	20	33.5	33	0.097

The body swivels for positioning purposes.
Max. 20 bar

3889

Compact Male Stud Elbow, Male NPT Thread



Stainless steel 316L, FKM

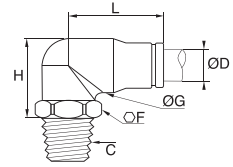

ØD	C		F	G	H	L	Kg
4	NPT1/8	3889 04 11	13	10	17.5	19	0.020
6	NPT1/8	3889 06 11	13	12.5	20	22.5	0.026
	NPT1/4	3889 06 14	14	12.5	20	22.5	0.034
8	NPT1/8	3889 08 11	13	15	25	24	0.035
	NPT1/4	3889 08 14	14	15	24	24	0.036
10	NPT1/4	3889 10 14	17	17.5	27.5	27.5	0.059
	NPT3/8	3889 10 18	19	17.5	28.5	26.5	0.067
12	NPT1/4	3889 12 14	22	20	31.5	32.5	0.086
	NPT3/8	3889 12 18	22	20	32.5	32.5	0.089
	NPT1/2	3889 12 22	22	20	27.5	32.5	0.098

The body swivels for positioning purposes.
Max. 20 bar

3889

Compact Stud Elbow, Male NPT Thread



Inch

Stainless steel 316L, FKM

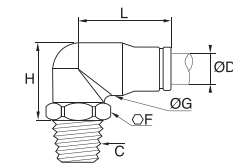

ØD	C		F	G	H	L	Kg
3/16	NPT1/8	3889 55 11	10	10	21	20	0.020
	NPT1/4	3889 55 14	14	10	21	20	0.025
1/4	NPT1/8	3889 56 11	13	12	22	23	0.025
	NPT1/4	3889 56 14	14	12	22	23	0.033
3/8	NPT1/4	3889 60 14	17	17.5	28	30.5	0.059
	NPT3/8	3889 60 18	19	17.5	28	30.5	0.067
1/2	NPT1/4	3889 62 14	22	20	34	33	0.089
	NPT3/8	3889 62 18	22	20	34	33	0.089
	NPT1/2	3889 62 22	22	20	27	33	0.091

The body swivels for positioning purposes.
5/32" (4 mm) and 5/16" (8 mm) also available.
Max. 20 bar

3879/3979

Compact Stud Elbow, Male BSPP Thread



FKM, stainless steel 316L

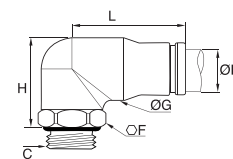

ØD	C			F	G	H	L	Kg
4	G1/8	3879 04 10	3979 04 10	10	11	22	19	0.021
	G1/4	3879 04 13	3979 04 13	17	11	20	19	0.027
6	G1/8	3879 06 10	3979 06 10	13	12	24	24	0.029
	G1/4	3879 06 13	3979 06 13	17	12	22	24	0.034
8	G1/8	3879 08 10	3979 08 10	13	15	25	25	0.035
	G1/4	3879 08 13	3979 08 13	17	15	25	25	0.039
	G3/8	3879 08 17	3979 08 17	21	15	23	25	0.047
10	G1/4	3879 10 13	3979 10 13	18	17	43	31	0.058
	G3/8	3879 10 17	3979 10 17	21	17	40	31	0.066
12	G1/4	3879 12 13	3979 12 13	17	20	33	33	0.077
	G3/8	3879 12 17	3979 12 17	21	20	33	33	0.082
	G1/2	3879 12 21	3979 12 21	24	20	30	33	0.097

The body swivels for positioning purposes.
Max. 20 bar

Stud Fittings

3803/3903 Stud Run Tee, Male BSPT Thread



Stainless steel 316L, FKM

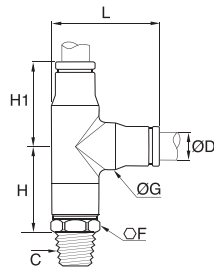

ØD	C			F	G	H	H1	L	Kg
4	R1/8	3803 04 10	3903 04 10	10	10	19	17	22	0.020
	R1/8	3803 06 10	3903 06 10	13	12	22	20	26.5	0.038
6	R1/4	3803 06 13	3903 06 13	14	15	22	20	27	0.035
	R1/8	3803 08 10	3903 08 10	14	15	24	23	31	0.049
8	R1/4	3803 08 13	3903 08 13	14	15	24	23	31	0.055
	R1/4	3803 10 13	3903 10 13	19	17.5	30	29	38	0.070
10	R3/8	3803 10 17	3903 10 17	19	17.5	30	29	38	0.083

The body swivels for positioning purposes.

3803 Stud Run Tee, Male NPT Thread



Stainless steel 316L, FKM

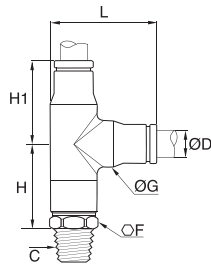

ØD	C			F	G	H	H1	L	Kg
4	NPT1/8	3803 04 11		11	10	21	19	25	0.021
	NPT1/8	3803 06 11		13	12	24	21	27	0.038
6	NPT1/4	3803 06 14		14	12	24	21	27.5	0.037
	NPT1/8	3803 08 11		14	15	26.5	24	30.5	0.050
8	NPT1/4	3803 08 14		14	15	26.5	24	30.5	0.048
	NPT1/4	3803 10 14		19	17.5	31	29.5	37.5	0.082

The body swivels for positioning purposes.

3893/3993 Stud Run Tee, Male BSPP and Metric Thread



Stainless steel 316L, FKM

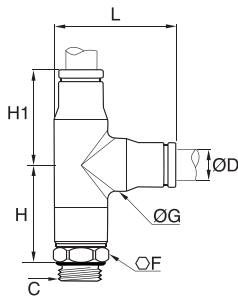

ØD	C			F	G	H	H1	L	Kg
4	M5x0.8	3893 04 19	3993 04 19	10	11	21.5	19	24.5	0.023
	G1/8	3893 04 10	3993 04 10	13	11	21.5	19	24.5	0.026
	G1/4	3893 04 13	3993 04 13	17	11	22	19	28	0.033
6	G1/8	3893 06 10	3993 06 10	13	12	26.5	24	30	0.038
	G1/4	3893 06 13	3993 06 13	17	12	26	24	32	0.043
8	G1/8	3893 08 10	3993 08 10	14	15	27.5	25	32	0.049
	G1/8	3893 08 13	3993 08 13	17	15	28	25	33.5	0.053
10	G3/8	3893 08 17	3993 08 17	21	15	27	25	35.5	0.094
	G1/4	3893 10 13	3993 10 13	19	17	34	31	39	0.081
	G3/8	3893 10 17	3993 10 17	21	17	35.5	31	39.5	0.082

The body swivels for positioning purposes.

3808/3908 Stud Branch Tee, Male BSPT Thread



Stainless steel 316L, FKM

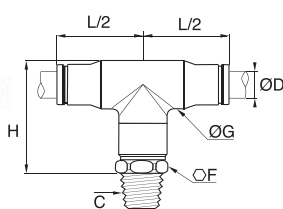

ØD	C			F	G	H	L/2	Kg
4	R1/8	3808 04 10	3908 04 10	10	10	23.5	19	0.020
	R1/8	3808 06 10	3908 06 10	13	12	27.5	24	0.038
6	R1/4	3808 06 13	3908 06 13	14	12	27.5	24	0.044
	R1/8	3808 08 10	3908 08 10	14	15	32	25	0.049
8	R1/4	3808 08 13	3908 08 13	14	15	32	25	0.055
	R3/8	3808 08 17	3908 08 17	19	15	33	25	0.068
10	R1/4	3808 10 13	3908 10 13	19	17.5	37.5	31	0.082
	R3/8	3808 10 17	3908 10 17	19	17.5	37.5	31	0.083

The body swivels for positioning purposes.

These models enable compact connection for elbow outlets, thus allowing space saving.

Stud Fittings

3808

Stud Branch Tee, Male BSPT Thread



Stainless steel 316L, FKM

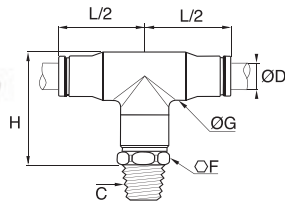

ØD	C		F	G	H	L/2	Kg
4	NPT1/8	3808 04 11	11	10	22	19	0.026
6	NPT1/8	3808 06 11	13	12.5	30	24	0.031
	NPT1/4	3808 06 14	14	12.5	30	24	0.044
8	NPT1/8	3808 08 11	14	15	34	25	0.042
	NPT1/4	3808 08 14	14	15	34	25	0.054
10	NPT1/4	3808 10 14	19	17.5	40	31	0.082
	NPT3/8	3808 10 18	19	17.5	40	31	0.084

The body swivels for positioning purposes.

3898/3998

Stud Branch Tee, Male BSPP and Metric Thread



Stainless steel 316L, FKM

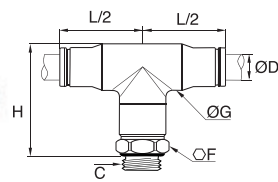

ØD	C			F	G	H	L/2	Kg
4	M5x0.8	3898 04 19	3998 04 19	10	11	27	19	0.024
	G1/8	3898 04 10	3998 04 10	13	11	27	19	0.026
	G1/4	3898 04 13	3998 04 13	17	11	27	19	0.032
6	M5x0.8	3898 06 19	3998 06 19	13	12	33.5	24	0.038
	G1/8	3898 06 10	3998 06 10	13	12	33	24	0.038
	G1/4	3898 06 13	3998 06 13	17	12	32	24	0.043
8	G1/8	3898 08 10	3998 08 10	14	15	35	25	0.051
	G1/4	3898 08 13	3998 08 13	17	15	35	25	0.053
	G3/8	3898 08 17	3998 08 17	21	15	34.5	25	0.058
10	G1/4	3898 10 13	3998 10 13	19	17	43	31	0.082
	G3/8	3898 10 17	3998 10 17	21	17	41	31	0.087

The body swivels for positioning purposes.

LF 3800 : 316L stainless steel (body) with 303 stainless steel collet, FKM seals
 LF 3900 : full 316L, FKM seals

Tube-to-Tube Fittings

3806/3906 Equal Straight Connector



Stainless steel 316L, FKM

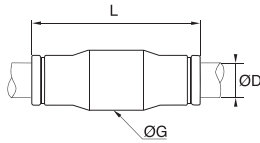

ØD			G	L	Kg
4	3806 04 00	3906 04 00	10	29	0.009
6	3806 06 00	3906 06 00	12	34	0.015
8	3806 08 00	3906 08 00	15	36	0.019
10	3806 10 00	3906 10 00	17.5	45	0.033
12	3806 12 00	3906 12 00	20	46.5	0.040

3806/3906 Equal Straight Connector



Inch

Stainless steel 316L, FKM

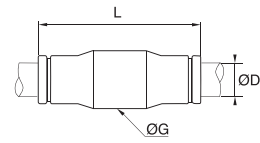

ØD			G	L	Kg
3/16	3806 55 00	3906 55 00	11	31	0.010
1/4	3806 56 00	3906 56 00	12	36	0.015
3/8	3806 60 00	3906 60 00	17	47	0.030
1/2	3806 62 00	3906 62 00	20	48	0.039

5/32" (4 mm) and 5/16" (8 mm) also available

3802/3902 Equal Stud Elbow



Stainless steel 316L, FKM

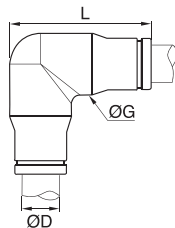

ØD			G	L	Kg
4	3802 04 00	3902 04 00	10	21.5	0.015
6	3802 06 00	3902 06 00	12	26.5	0.024
8	3802 08 00	3902 08 00	15	29.5	0.031
10	3802 10 00	3902 10 00	17.5	36.5	0.050
12	3802 12 00	3902 12 00	20	40	0.072

3802/3902 Equal Stud Elbow,



Inch

Stainless steel 316L, FKM

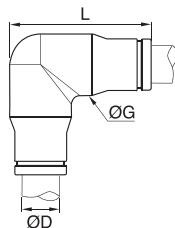

ØD			G	L	Kg
3/16	3802 55 00	3902 55 00	11	25	0.011
1/4	3802 56 00	3902 56 00	12	29	0.024
3/8	3802 60 00	3902 60 00	17	38	0.047
1/2	3802 62 00	3902 62 00	20	43	0.071

5/32" (4 mm) and 5/16" (8 mm) also available

3804/3904 Equal Tee



Stainless steel 316L, FKM

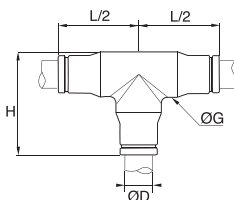

ØD			G	H	L/2	Kg
4	3804 04 00	3904 04 00	10	22	19	0.020
6	3804 06 00	3904 06 00	12	26	24	0.031
8	3804 08 00	3904 08 00	15	29.5	25	0.040
10	3804 10 00	3904 10 00	17.5	36.5	31	0.064
12	3804 12 00	3904 12 00	20	40	33	0.088

Bulkhead Connector Fittings

3804/3904 Equal Tee



Stainless steel 316L, FKM

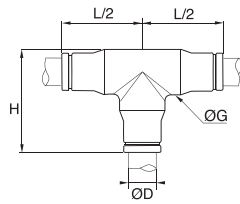

ØD			G	H	L/2	Kg
3/16	3804 55 00	3904 55 00	11	25	20	0.017
1/4	3804 56 00	3904 56 00	12	30	23	0.031
3/8	3804 60 00	3904 60 00	17	38	29	0.059
1/2	3804 62 00	3904 62 00	20	43	33	0.089

5/32" (4 mm) and 5/16" (8 mm) also available

3816/3916 Equal Bulkhead Connector



Stainless steel 316L, FKM

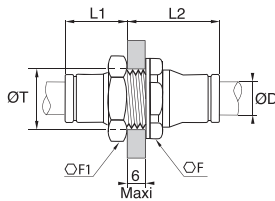

ØD			F	F1	L1	L2	ØT	Kg
4	3816 04 00	3916 04 00	13	14	13.5	19.5	13	0.017
6	3816 06 00	3916 06 00	17	17	16.5	21.5	14	0.027
8	3816 08 00	3916 08 00	19	19	18	24	16	0.034
10	3816 10 00	3916 10 00	22	22	21.5	27.5	21	0.049
12	3816 12 00	3916 12 00	24	24	24	29	23	0.059

IP55 sealing

3816/3916 Equal Bulkhead Connector



Stainless steel 316L, FKM

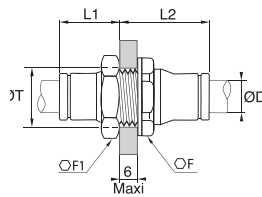

ØD			F	F1	L1	L2	ØT	Kg
3/16	3816 55 00	3916 55 00	17	13	15	18	12.5	0.017
1/4	3816 56 00	3916 56 00	19	17	19	21	15	0.026
3/8	3816 60 00	3916 60 00	22	22	22	27	21	0.052
1/2	3816 62 00	3916 62 00	27	27	25	28	25	0.076

IP55 sealing

5/32" (4 mm) and 5/16" (8 mm) also available

LF 3800/LF 3900 push-in fittings allow connection with several types of Parker Legris tubing shown in Chapter 3 of this catalogue, "Technical Tubing and Hose":

- PFA tubing
- Fluoropolymer tubing
- Polyethylene tubing
- Semi-rigid polyamide and flexible Crystal polyurethane tubing

Plug-In Fittings and Accessories

3866/3966 Push-In Reducer



Stainless steel 316L, FKM

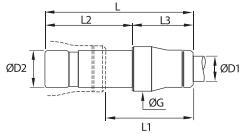

ØD1	ØD2			G	L	L1	L2	L3	Kg
4	6	3866 04 06	3966 04 06	10	35	19	19	16	0.009
	8	3866 04 08	3966 04 08	10	34	17	20	14	0.011
6	8	3866 06 08	3966 06 08	12	42	24	23	19	0.015
	10	3866 06 10	3966 06 10	12	41	19	25	16	0.019
8	10	3866 08 10	3966 08 10	15	45	22.5	25	20	0.020
	12	3866 08 12	3966 08 12	15	43	20	26	17	0.025
10	12	3866 10 12	3966 10 12	17	50	23	26	24	0.029

3826 Blanking Plug



Stainless steel 316L

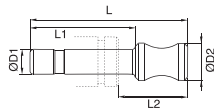

ØD1	ØD2		L	L1	L2	Kg
4	6	3826 04 00	25	17	11	0.003
6	8	3826 06 00	30.4	19.5	13.5	0.007
8	10	3826 08 00	33	20	14	0.014
10	12	3826 10 00	40	25	17	0.025
12	14	3826 12 00	43	26	19	0.038

3800 Pre-Grooving Tool for Metallic Tubing

Treated steel

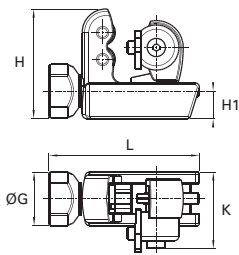

	G	H	H1	K	L	Kg
3800 70 00	25	51	13	36	70	0.326

This tool correctly pre-grooves 4-12 mm O.D. and 3/16"-1/2" O.D. stainless steel tubing, to ensure that the LF 3800/LF 3900 collet grips the tube securely.

0605 Fluoropolymer Tape

FKM



	Kg
0605 12 12	0.012

Can be used for temperatures from - 250°C to +260°C.
Chemically inert and resistant to gases, acids, solvents, hydrocarbons, oils, alkalines, steam etc.
Non-toxic, waterproof, self-lubricating.
In accordance with CFR21.
Can be used on all materials.
Used to facilitate the preparation of leak-free threaded joints.
Supplied on a reel, length = 12 m, width = 12.7 mm, thickness 0.08 mm.

3000 70 Dismounting Tool

Treated steel

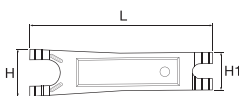

	H	H1	L	Kg
3000 70 00	25	20	96	0.021

For dismantling LF 3000® tubing/fittings where access is difficult, we recommend the use of this dismounting tool.

Cartridges and Customised Products





Cartridges

Polymer Cartridges

Compressed Air

3100
Carstick®
Page 2-8



3086
Quick Fitting
Page 2-8



3089
Quick Fitting
Page 2-8



3082
Quick Fitting
Page 2-8



3081
Quick Fitting
Page 2-9



3088
Quick Fitting
Page 2-9



3100 - Inch
Carstick®
Page 2-8



Fluids and Gases

6300
Carstick® LIQUIfit®
Page 2-10



6300 - Inch
Carstick® LIQUIfit®
Page 2-10



Metal Cartridges

Fluids and Gases

3600
Page 2-13



3800
3900
Page 2-13



FTL
Page 2-13



TLT
Disconnection
Tool
Page 2-13



Polymer Cartridges: LF 3000® and LIQUIfit® Carstick®, Quick Fitting

Parker Legris has developed the range of patented **Carstick®** cartridges guaranteeing **the integrity of the sealing system** before and after assembly in non-threaded cavities. The **compact design** of the one-piece Carstick® cartridge enables **automation** of your manufacturing process and improves the **reliability** of your system.

Product Advantages

- Time-Saving**
 - No thread to be machined for inserting the fitting into its cavity
 - Seal pre-assembled, greased and protected
 - Self-centring of the cartridge in the cavity
 - Product protected against contamination, from manufacture to installation
 - Possible to have several tube diameters in the same cavity (Quick Fitting)
- Proven Technology**
 - Technical performances of the LF 3000®
 - Push-in connection
 - Full flow
 - Optimum flow at pressure and vacuum
 - LIQUIfit® Carstick® compatible with drinking water and food fluids
- Automated Installation**
 - Ensures that the product will be correctly assembled
 - Connection fully integrated in the cavity
 - Carstick® packaging designed for an automatic assembly process



Applications

- Robotics
- Automotive Process
- Pneumatics
- Semi-Conductors
- Water & Beverage
- Packaging
- Vacuum

Technical Characteristics

	LF 3000® Carstick® and Quick Fitting	LIQUIfit® Carstick®
Compatible Fluids	Compressed air	Food fluids, inert gases
Working Pressure	Vacuum to 20 bar	Vacuum to 16 bar*
Working Temperature	-20°C to +80°C	-10°C to +95°C*

Reliable performance is dependent upon the type of fluid conveyed, component materials and tubing being used. Guaranteed for use with a vacuum of 755 mm Hg (99% vacuum). *The pressure / temperature information is shown in Chapter 1, in the "LIQUIfit®" section.

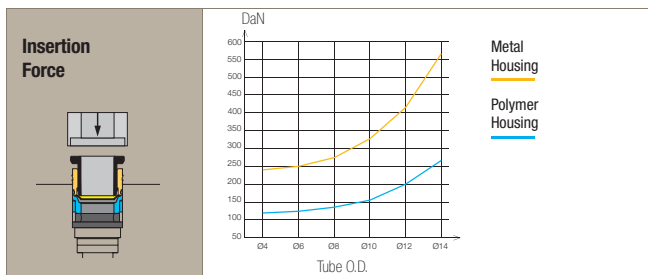

Component Materials

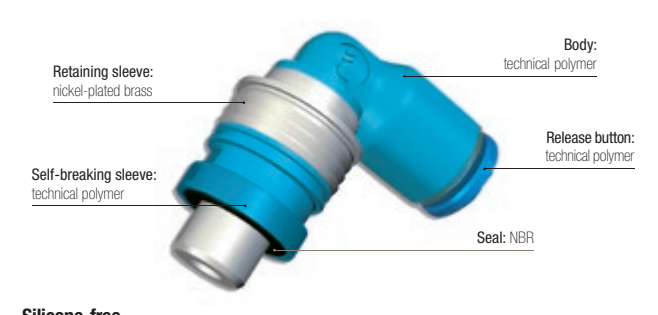
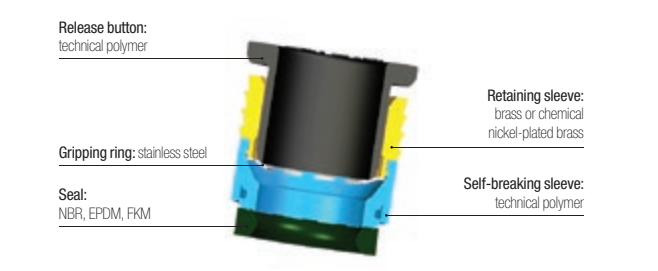

Silicone-free

Regulations

- | | | |
|---|--|---|
| <p>LF 3000® Carstick® and Quick Fitting
 ISO 14743: Pneumatic fluid power, push-in fittings for thermoplastic tubes
 DI: 2002/95/CE (RoHS), 2011/65/CE
 DI: 97/23/CE (PED)</p> | <p>LIQUIfit® Carstick®
 RG: 1935/2004/CE
 FDA: 21 CFR 177.1550
 NSF 51 to 95°C
 ACS
 DM 174 (Italy)</p> | <p>DI: 2002/95/CE (RoHS), 2011/65/CE
 DI: 97/23/CE (PED)
 WRAS
 NSF/ANSI 61 - C HOT
 KTW: cartridges on request</p> |
|---|--|---|

Assembly Options

Cartridge solutions quickly pay for themselves when they enable production to be rationalised:

Threaded Fittings

For small quantities or non-standard assembly operations:
The threaded solution remains the most advantageous.



Carstick®: Manual Assembly

For medium quantities:
Assembly by manually-operated press offers the most economic solution.



Carstick®: Automated Assembly

For repetitive operations and large quantities:
Investment in an automated manufacturing solution is quickly recovered, providing significant long-term savings.

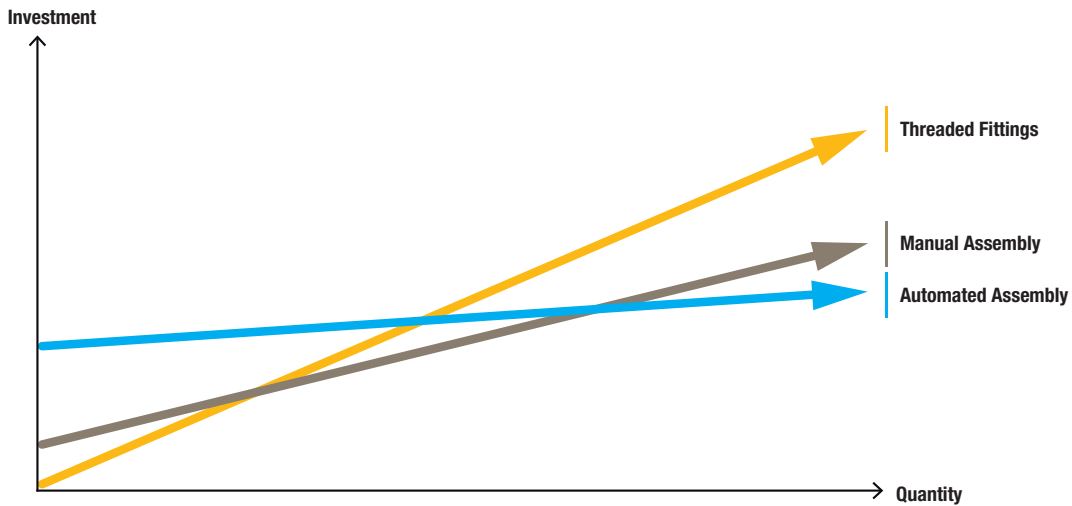

Installation

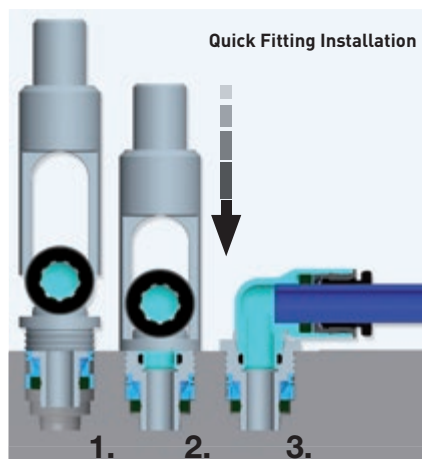
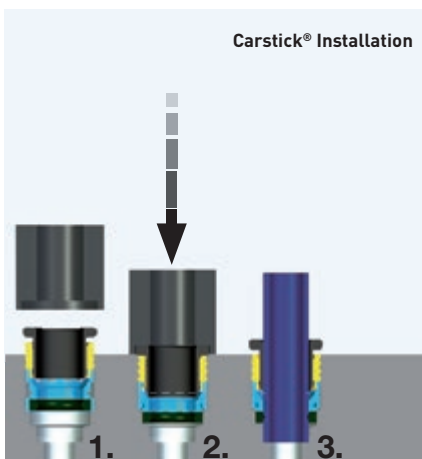

1. Self-centering of the cartridge in the cavity.
2. The seal protection is broken.
The seal slides into the cavity.
The cartridge is in place.



3. Tube connection.

Assembly tool:
For details on the assembly tool, please contact us.



Assembly tool:
For details on the assembly tool, please contact us.



Polymer Cartridges for Compressed Air

3100 Carstick® Cartridge

Brass, NBR

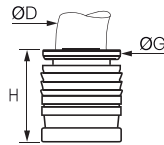

ØD		G	G1	H	L	kg
4	3100 04 00	8	11	10	554	0.001
6	3100 06 00	10	14.5	11.5	629	0.002
8	3100 08 00	13	15	15	794	0.002
10	3100 10 00	15.5	19.5	17	930	0.005
12	3100 12 00	19.5	21	19.5	1038	0.010
14	3100 14 00	21	24.5	22.5	1110	0.013

50 cartridges per Carstick®.

For cartridge Ø14, please consult us for the cavity dimensions.



3100 Carstick® Cartridge

Nickel-plated brass, NBR

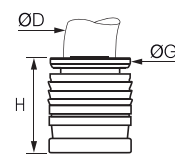

ØD		G	G1	H	L	kg
1/8	3100 53 00 99	7	10	9	508	0.002
1/4	3100 56 00 99	10.5	14.5	12	600	0.003
3/8	3100 60 00 99	15.5	19	16.5	930	0.006

50 cartridges per Carstick®.

5/32" (4 mm) and 5/16" (8 mm) also available.



3086 Quick Fitting Reducer

Nickel-plated brass, NBR

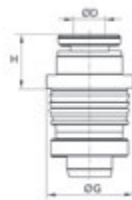

ØD		Cavity	G	H	kg
4	3086 04 06	6	12.5	7	0.005
6	3086 06 08	8	14	7.5	0.008

Available on request

3089 Quick Fitting Elbow

Technical polymer, nickel-plated brass, NBR

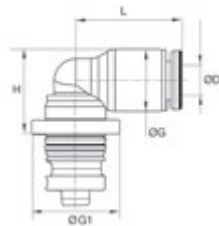

ØD		Cavity	G	G1	H	L	kg
4	3089 04 04	4	9	12.5	11.5	15	0.004
	3089 04 06	6	9	12.5	11.5	15	0.005
	3089 06 04	4	11	12.5	14	17	0.004
6	3089 06 06	6	11	12.5	12.5	17	0.006
	3089 06 08	8	11	14.5	13	17	0.010
8	3089 08 08	8	13.5	14.5	16	23	0.011
	3089 08 10	10	13.5	19	16	23	0.021
10	3089 10 10	10	16	19	19	26.5	0.017
	3089 10 12	12	16	20	19	26.5	0.028
12	3089 12 12	12	19	20	22	31	0.030

3082 Quick Fitting Extended Elbow

Technical polymer, nickel-plated brass, NBR

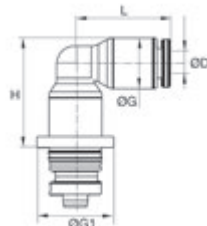

ØD		Cavity	G	G1	H	L	kg
4	3082 04 04	4	9	12.5	16	15	0.006
	3082 04 06	6	9	12.5	15	15	0.009
6	3082 06 06	6	9	12.5	23	19	0.010
	3082 06 08	8	10.5	14	29	18.5	0.014
8	3082 08 08	8	13.5	17	29.5	22.5	0.021
	3082 08 10	10	13.5	19	29	23	0.025
10	3082 10 10	10	16	20	33	26	0.029
	3082 10 12	12	16	20	33	26	0.040
12	3082 12 12	12	19	23	39	31	0.056

Available on request

Polymer Cartridges for Compressed Air

3081 Quick Fitting 45° Elbow

Technical polymer, nickel-plated brass, NBR

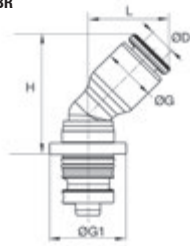

ØD		Cavity	G	G1	H	L	kg
4	3081 04 04	4	9	12.5	19	13	0.004
6	3081 06 06	6	11	12.5	22	14.5	0.006
8	3081 08 08	8	13.5	14.5	26	19	0.011
10	3081 10 10	10	16	19	30	22	0.017
12	3081 12 12	12	19	20	35.5	26	0.031

Available on request

3088 Quick Fitting Tee

Technical polymer, nickel-plated brass, NBR

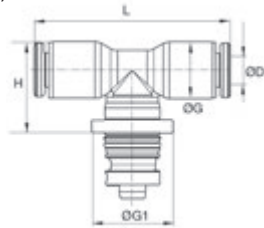

ØD		Cavity	G	G1	H	L	kg
4	3088 04 04	4	9	12.5	14	30	0.005
	3088 04 06	6	8.6	12.5	12.5	29.5	0.006
6	3088 06 06	6	11	12.5	14.5	34	0.007
	3088 06 08	6	10.6	14.5	15	33.5	0.011
8	3088 08 08	8	14	14.5	19	46	0.013
	3088 08 10	8	14	19	19	46	0.023
10	3088 10 10	10	16	19	21	53	0.020
	3088 10 12	10	16	20	21	53	0.031
12	3088 12 12	12	19	20	24	61	0.035

Cavity Dimensions

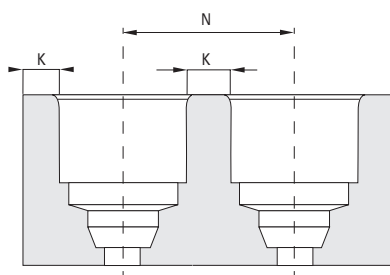
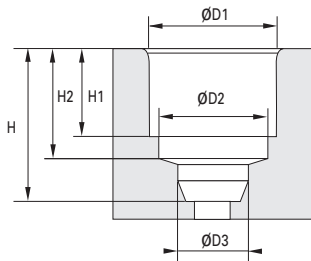

Carstick® and Quick Fitting Metric

Cavity	ØD3	H	H1	H2
4	4.1	10	6	8.15
6	6.1	12	7.5	9.65
8	8.15	15.5	9.9	12.45
10	10.25	19	11.7	14.35
12	12.17	22	13.9	16.75

Carstick® Inch

Cavity	ØD3	H	H1	H2
1/8	3.25	9.5	5.3	7.45
5/32*	4.1	10	6	8.15
1/4	6.45	12.5	8	10.15
5/16*	8.15	15.5	9.9	12.45
3/8	9.65	19	11.7	14.35

Polyamide Cavity

Cavity	ØD1	ØD2	N*	N**	K
4	8.25	7.05	9.8	12.3	1.5
6	10.2	9.15	12.2	12.3	2
8	12.15	10.85	14.2	14.3	2
10	14.8	13.2	16.8	19	2
12	17.5	15.5	20	20.2	2.5

Cavity	ØD1	ØD2	N	K
1/8	7.05	6.02	8.6	1.5
5/32*	8.25	7.05	9.75	1.5
1/4	10.55	9.35	12.6	2
5/16*	12.15	10.85	14.2	2
3/8	14.8	13.1	16.8	2

Aluminium Cavity

Cavity	ØD1	ØD2	N*	N**	K*	K**
4	8.25	7.5	11.5	12.3	3	1.5
6	10.3	9.15	13.5	12.3	3	2
8	12.2	10.85	15.2	15.2	3	2
10	15.05	13.2	17.1	19	2	2
12	17.5	15.5	20	20.2	2.5	2.5

Cavity	ØD1	ØD2	N	K
1/8	7.1	6.2	8.6	1.5
5/32*	8.25	7.05	11.25	3
1/4	10.6	9.35	12.65	2
5/16*	12.2	10.85	15.2	3
3/8	15.05	13.1	17.1	2

Brass Cavity

Cavity	ØD1	ØD2	N*	N**	K*	K**
4	8.25	7.05	10.25	12.3	2	1.5
6	10.25	9.1	12.25	12.3	2	2
8	12.2	10.85	14.25	14.3	2	2
10	15.05	13.2	17.1	19	2	2
12	17.65	15.5	20	20.2	2.5	2.5

Cavity	ØD1	ØD2	N	K
1/8	7.1	6.2	8.6	1.5
5/32*	8.25	7.05	10.25	2
1/4	10.6	9.35	12.65	2
5/16*	12.2	10.85	14.25	2
3/8	15.05	13.1	17.1	2

Please consult us for detailed drawings of cavity dimensions and tolerances.

All our dimensions are in millimeters.

*Carstick® / **Quick Fitting

*5/32" = 4 mm and 5/16" = 8 mm

Polymer Cartridges for Fluids and Gases

6300

LIQUIfit® Cartridge

Brass, EPDM

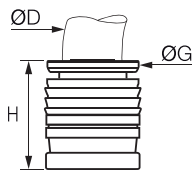

ØD		G	G1	H	L	kg
4	6300 04 00	8	11	10	554	0.002
6	6300 06 00	10	14.5	11.5	629	0.002
8	6300 08 00	13	15	15	794	0.003
10	6300 10 00	15.5	19.5	17	930	0.005
12	6300 12 00	18.5	21	19.5	1038	0.010

50 cartridges per Carstick®



6300

LIQUIfit® Cartridge

Brass, EPDM

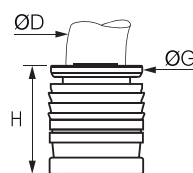

ØD		G	G1	H	L	kg
1/4	6300 56 00	10.5	14.5	12.5	600	0.002
3/8	6300 60 00	15.5	19	17	930	0.005
1/2	6300 62 00	22	25	23	1038	0.011

50 cartridges per Carstick®

5/32" (4 mm) and 5/16" (8 mm) also available.



LIQUIfit® Cavity Dimensions

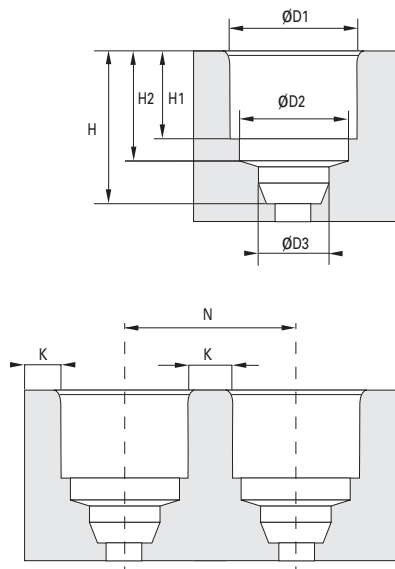

LIQUIfit® Carstick®

Metric

LIQUIfit® Carstick®

Inch

Cavity	ØD3	H	H1	H2
4	4.1	10	6	8.15
6	6.1	12	7.5	9.65
8	8.15	15.5	9.9	12.45
10	10.25	19	11.7	14.35
12	12.17	22	13.9	16.75

Cavity	ØD3	H	H1	H2
1/8	3.25	9.5	5.3	7.45
5/32*	4.1	10	6	8.15
1/4	6.45	12.5	8	10.15
5/16*	8.15	15.5	9.9	12.45
3/8	9.65	19	11.7	14.35

Polyamide Cavity

Cavity	ØD1	ØD2	N	K
4	8.25	7.05	9.8	1.5
6	10.2	9.15	12.2	2
8	12.15	10.85	14.2	2
10	14.8	13.2	16.8	2
12	17.5	15.5	20	2.5

Cavity	ØD1	ØD2	N	K
1/8	7.05	6.02	8.6	1.5
5/32*	8.25	7.05	9.75	1.5
1/4	10.55	9.35	12.6	2
5/16*	12.15	10.85	14.2	2
3/8	14.8	13.1	16.8	2

Aluminium Cavity

Cavity	ØD1	ØD2	N	K
4	8.25	7.5	11.5	3
6	10.3	9.15	13.5	3
8	12.2	10.85	15.2	3
10	15.05	13.2	17.1	2
12	17.5	15.5	20	2.5

Cavity	ØD1	ØD2	N	K
1/8	7.1	6.2	8.6	1.5
5/32*	8.25	7.05	11.25	3
1/4	10.6	9.35	12.65	2
5/16*	12.2	10.85	15.2	3
3/8	15.05	13.1	17.1	2

Brass Cavity

Cavity	ØD1	ØD2	N	K
4	8.25	7.05	10.25	2
6	10.25	9.1	12.25	2
8	12.2	10.85	14.25	2
10	15.05	13.2	17.1	2
12	17.65	15.5	20	2.5

Cavity	ØD1	ØD2	N	K
1/8	7.1	6.2	8.6	1.5
5/32*	8.25	7.05	10.25	2
1/4	10.6	9.35	12.65	2
5/16*	12.2	10.85	14.25	2
3/8	15.05	13.1	17.1	2

*5/32" = 4 mm and 5/16" = 8 mm

Please consult us for detailed drawings of cavity dimensions and tolerances.

All our dimensions are in millimeters.



Metal Cartridges

For full **compatibility** with **many fluids** and severe conditions (**+150°C**), Parker Legris has developed two types of patented cartridges. Using our metal cartridges allows for **optimisation of installation configurations** and for the FTL, the possibility of removal.

Product Advantages

- LF Cartridges** | All the advantages of the LF 3600, LF 3800 and LF 3900 fittings applied to cartridge technology
 - LF 3600**
 - LF 3800** | All-metal product to provide the greatest mechanical strength and chemical resistance
 - LF 3900** | Resistant at high temperatures (+150°C)
Can be installed in either polymer or metal housings
- FTL Cartridge** | Possibility to have several tubing diameters in the same cavity
Visible retention and sealing system, can be disassembled using the dedicated tool



Applications

- Robotics
- Automotive Process
- Pneumatics
- Semi-Conductors
- Refrigeration
- Packaging
- Vacuum

Technical Characteristics

LF 3600, LF 3800, LF 3900		FTL Cartridge	
Compatible Fluids	Fluids: see corresponding chapters	Compatible Fluids	Compressed air
Working Pressure	Vacuum to 30 bar	Working Pressure	0.01 to 16 bar
Working Temperature	-20°C to +150°C	Working Temperature	-25°C to +80°C
Component Materials	See corresponding chapters	Component Materials	Body: brass Release button: technical polymer Gripping ring: stainless steel Seals: NBR

Regulations

LF 3600, LF 3800, LF 3900
 DI: 97/23/CE (PED)
 RG: 21 CFR (FDA)
 RG: 1935/2004/CE
 (minimum flow 0.02 l/hr)
 DI: 2011/65/CE (RoHS)
 USDA NSF H1: grease
 ASTM B733-04: self-catalytic nickel coating
 DI: 94/9/CE (ATEX)

FTL
 DI: 97/23/CE (PED)
 DI: 2011/65/CE (RoHS)

Reliable performance is dependent upon the type of fluid conveyed, component materials and tubing being used. Guaranteed for use with a vacuum of 755 mm Hg (99% vacuum).

Metal Cartridges for Fluids and Gases

3600

One-Piece Cartridge



FDA chemical nickel-plated brass, FKM

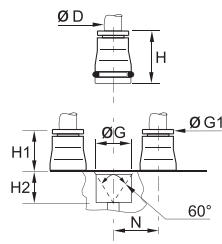

ØD		G	G1	H	H1	H2	N	kg
4	3600 04 00	9.8	8	17	8.5	8.5	11	0.006
6	3600 06 00	12.1	10	19	10.5	8.5	13.5	0.009
8	3600 08 00	14.8	13	21	12.5	8.5	16	0.012
10	3600 10 00	17.5	15	24.5	14	10.5	20	0.019
12	3600 12 00	20	17	25	14.5	10.5	22.5	0.023
14	3600 14 00	22	20	28.5	16.5	12	25	0.031

3800/3900

One-Piece Cartridge



Stainless steel 316L, FKM

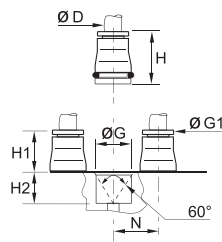

ØD			G	G1	H	H1	H2	N	kg
4	3800 04 00	3900 04 00	9.8	8	17	8.5	8.5	11	0.006
6	3800 06 00	3900 06 00	12.1	10	19	10.5	8.5	13.5	0.008
8	3800 08 00	3900 08 00	14.8	13	21	12.5	8.5	16	0.012
10	3800 10 00	3900 10 00	17.5	15	24.5	14	10.5	20	0.019
12	3800 12 00	3900 12 00	20	17	25	14.5	10.5	22.5	0.022

3800: collet in stainless steel 303

3900: collet in stainless steel 316L

Cavity dimensions are available in chapter 2.

FTL

Cartridge

Brass, NBR

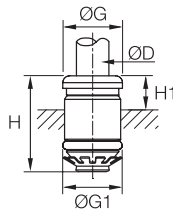

ØD	Cavity		G	G1	H	H1	H2	kg
4	4	FTL4	8	8	14.5	4.5	7.5	0.003
4	6	FTL6-4	8	10	17	4.5	9.5	0.003
6	6	FTL6	10.5	10	17	4.5	9.5	0.004
4	8	FTL8-4	8	12	17.5	5	10.5	0.008
6	8	FTL8-6	10.5	12	18	5.5	11	0.008
8	8	FTL8	13.5	12	19	6.5	12	0.005

* Can be mounted in a short hole with extremely close porting

TLT

Dismounting Tool

Nickel-plated brass

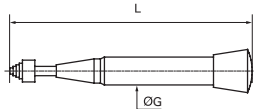

	G	L	kg
TLT	28	156	0.235

* Can be mounted in a short hole with extremely close porting

Cavity Dimensions

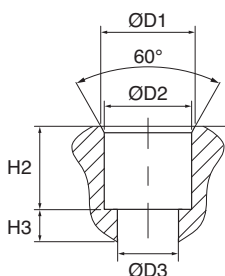

FTL Cartridge

Cavity	ØD1	ØD2	ØD3	H2	H3
4	9	8	5.5	9	1.5
6	11	10	8	11	1.5
8	13	12	8.5	11.5	1.5
4C*	9	8	5.5	6	1.5
6C*	11	10	8	6	1.5
8C*	13	12	8.5	6	1.5

*Can be mounted in a short hole with extremely close porting

Customised Solutions

Parker Legris has made **the development of customised products** one of its specialities. These dedicated products provide our customers with a **technical and economic solution** which fully meets their needs.

Customised Solution Development Process

- 1. Define the Function Parameters**

Specify the pressure, temperature, environment, fluids, materials and product function you need.

Estimate the quantity requirements.

Our product engineers are available to help you refine your requirements.
- 2. Send Your Request to our Technical Department**

Complete the online request form at www.parkerlegris.com, "Special Products".

Specify your quantities, technical and commercial requirements.
- 3. Request Analysis**

We assess the feasibility of the product based on the information you have sent us.

We carry out a technical study and produce drawings (prototypes and testing as necessary).
- 4. Parker Legris Proposes the Customised Solution**

We submit the optimum technical and commercial proposal.

If our proposal is accepted, we launch the production process.
- 5. Serial Production**

We will continually update you as to the status of your order and delivery date.

Customised Products

Cartridges



Fittings



Function Fittings



Multi-Connectors and Manifolds

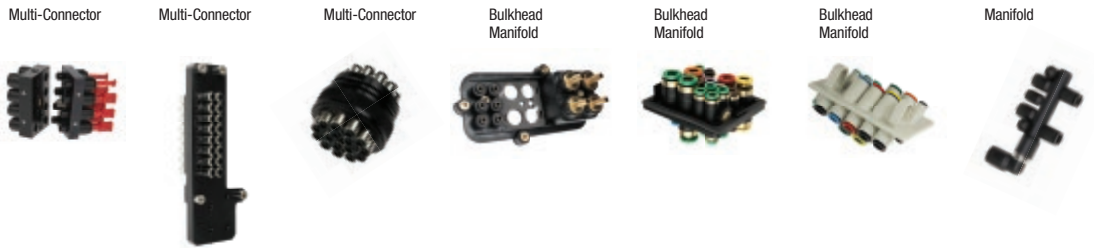

Tubing and Blowguns

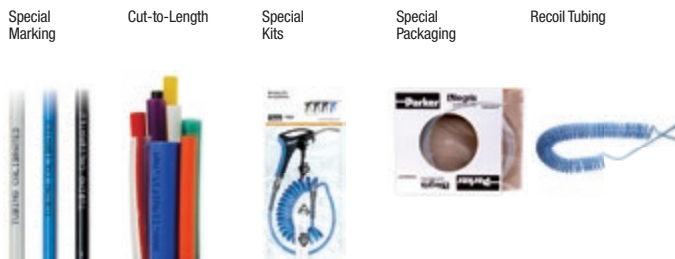

Valves



Skilled and Dedicated People Provide You with the Best Solution

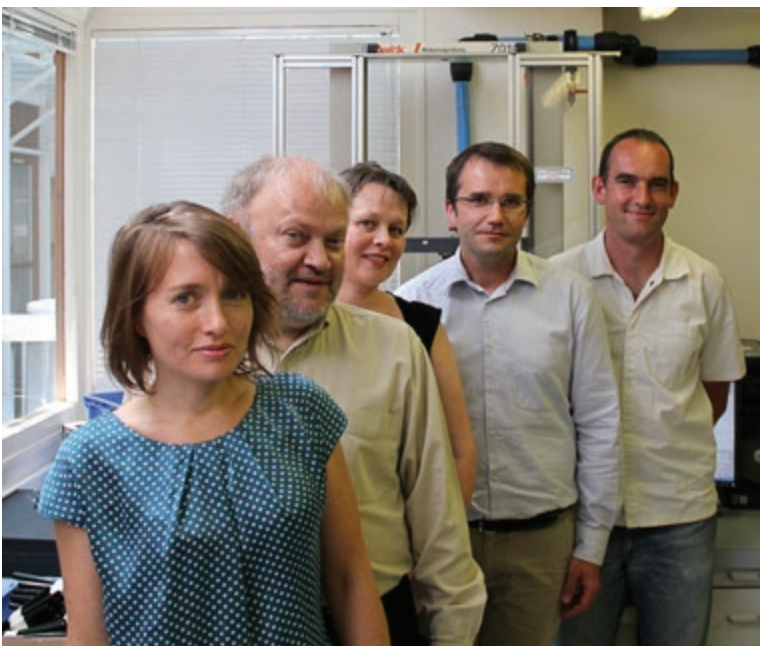

More than 40 years' experience in the design of push-in fittings also means more than 40 years spent in producing customised solutions for our customers.

We have a team of motivated and experienced engineers skilled in using the latest design tools: calculation and digital simulation tools, CAD, rheology (plastic injection modelling), quick prototyping and performance measuring in the laboratory.

Customised Fittings

To meet your needs, we can re-engineer the design of our fittings.

To complement our wide range of fittings, we can offer customised products.

Longer threads, different types of seal, special grease, specific cleaning processes, colours, packaging, etc. are all parameters which we can easily modify.



Low Temperature Carstick®

Resistant at -40°C



Filter Fittings for Medical and Clean Room Applications

Designed specifically for the filtration of air and gas

Can be made available with cleanliness specifications meeting requirements for medical processes and clean rooms



Metal Cartridges

Cartridges adapted to the client's dimensional and environmental requirements

Combination of the patented Carstick® system (seal protection) and LF 3600 performance levels



Multi-Component Stud Cartridges

Direct installation into a cavity with no thread

Can be custom-designed: seal, release button, etc.



Built-In Cartridge

Designed to be extremely compact, this cartridge can be built right into a cavity with no thread, and can also be disassembled



Fitting for Life Sciences & Clean Rooms

Specific gripping feature, cleanliness, oxygen-compatible grease

Reinforced leak testing

Special packaging



Fitting with Silencer, Two-in-One

Meeting requirements for saving space, this lightweight component includes a push-in connection as well as a silencer function



Fitting for the Transmission of Deionised Cooling Water in Frequency Inverters

Water-resistant materials

Stainless steel threads

Special seals



150°C Stud Fitting

Developed for use in steam circuits of coffee machines
 Extreme pressure and temperature resistance
 Fully compatible with drinking water circuits



Fitting for the Transmission of Water in Ceiling-Mounted Air Conditioning Systems

Brass body
 Double seal
 Crimped to hose



Orifice Fitting

Allows accurate flow regulation
 Minimum orifice diameter: 0.5 mm



Safety Standpipe Fitting

Perfect tear resistance
 Designed for applications with extremely high cadences



Non-Return Valve

Developed for systems carrying breathable air
 Low cracking threshold
 Oxygen-compatible grease, cleanliness



Compact Flow Regulator with Recessed Screw and FKM Seals

Improved external chemical resistance
 Custom logo



Multi-Connector

Allows disconnection of up to 16 tubes in a single operation
 Compact design suitable for the operating environment



Polymer Body with Integrated Fittings

For connection of pneumatic lines between the truck cab and chassis



Polymer Manifold

Reinforced integrated connections
 Dedicated to the distribution of compressed air for truck auxiliary systems e.g. cab seat, air horn, gauges...

Customised Tubing and Blowguns

We can adapt the formulation of polymers and customise tubing or blowguns to suit your requirements.

We can offer custom modifications such as: special additives and materials, non-standard diameters, customised marking, specific packaging, custom colours, custom tube cutting, pre-formed tubing, packaged solutions (tubes + fittings or couplers, blowgun kits).



Tube marked with customer's name
Tubes cut to specific lengths



Upon request, Parker Legris can propose any type of coiled tubing
All material available for standard requests can be adapted for recoil tubing



Marked with the customer's logo and part number
In lengths of 5 m, 10 m, 25 m, 50 m and 100 m, depending on the tube material
For flexible or semi-rigid tubing
Optimised tube packaging
Easy identification of the tube type
Integrated reel for easy handling



Marked with the customer's logo and part number
Up to 1000 m lengths
Immediate identification of the tube for easy handling
Suitable for workshop hose reels



Blowgun customised in customer's colours
Specific logo
Customised packaging



Production of a "tube + coupler + blowgun" assembly in dedicated and customised packaging

Customised Valves

Over and above our range of standard valves, Parker Legris can supply application-specific valves adapted to our customers' environment.

We offer custom modifications such as: longer threads, different types of seal, special grease, lever options, specific cleaning process, materials and surface treatments, assemblies, etc.



Transport Valve

Mounted on the wheel rims of armoured vehicles
For managing tyre pressures through an integrated inflation valve



Auto-Process Valve

Designed to simultaneously control both the inlet and outlet of a cooling line
Also allows one of the lines to be closed independently



Valve for Breathable Air

Dedicated to the transmission of oxygen-enriched air in hospital networks
Special seals, cleanliness, specific grease, very high reliability

Technical Tubing and Hose

Flexible Calibrated Tubing

Calibrated Multi-Tubing

Recoil Tubing and Hose

Calibrated Braided Hose

Accessories



Technical Tubing and Hose

PA Tubing

(P. 3-10)



Fluids: Compressed air, industrial fluids

Materials:

- 2 polyamide grades (semi-rigid and rigid)
- 7 colours

Pressure: 58 bar

Temperature: -40°C to +100°C

O.D. metric: 3 mm to 16 mm

O.D. inch: on request

Fireproof High Resistance PA Tubing

(P. 3-14)

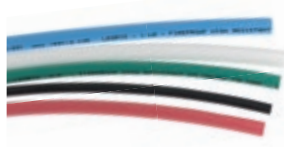

Fluids: compressed air, coolants, lubricants

Materials:

- Polyamide with flame retardant additive
- 5 colours

Pressure: 50 bar

Temperature: -50°C to +100°C

O.D. metric: 4 mm to 12 mm

Anti-Spark PA or PU Tubing, with or without PVC Sheath (P. 3-16 & 24)



Fluids : compressed air, coolants, industrial fluids

Materials :

- Semi-rigid polyamide with PVC sheath
- Polyurethane ether with PVC sheath
- Single layer polyurethane ether
- 4 colours

Pressure: 36 bar max.

Temperature: -20°C to +80°C

O.D. metric: 4 mm to 14 mm

PU Tubing

(P. 3-18)



Fluids: compressed air and food industry fluids ("crystal")

Materials:

- Polyurethane ester or ether
- Polyurethane food-grade "crystal"
- 7 colours

Pressure: 12 bar

Temperature: -20°C to +70°C

O.D. metric: 3 mm to 16 mm

O.D. inch: on request

Antistatic PU Tubing

(P. 3-22)



Fluids: compressed air

Materials:

- Polyurethane with conductive particles
- Black (10² Ω.m)

Pressure: 10 bar

Temperature: -20°C to +70°C

O.D. metric: 3 mm to 12 mm

PE Tubing

(P. 3-26)



Fluids: many fluids

Materials:

- Low density polyethylene
- 50% reticulated polyethylene, food-grade
- 7 colours

Pressure: 20 bar

Temperature: -40°C to +95°C

O.D. metric: 4 mm to 16 mm

O.D. inch: 1/8" to 1/2"

FEP Tubing

(P. 3-28)



Fluids: many fluids

Materials:

- Fluoropolymer: fluorinated ethylene propylene, food-grade
- Transparent

Pressure: 28 bar

Temperature: -40°C to +150°C

O.D. metric: 4 mm to 12 mm

PFA Tubing

(P. 3-30)



Fluids: many fluids

Materials:

- 3 grades of perfluoroalkoxy
- High purity food-grade, clear
- Standard food-grade, 3 "crystal" colours
- Antistatic (0.2 Ω.m), black

Pressure: 36 bar

Temperature: -196°C to +260°C

O.D. metric: 4 mm to 12 mm

PA Multi-Tubing

(P. 3-32)



Fluids: compressed air, industrial fluids

Materials:

- Semi-rigid polyamide with PVC sheath
- 6 colours

Pressure: 24 bar

Temperature: -40°C to +80°C

O.D. metric: 4 mm to 8 mm

Technical Tubing and Hose

Twin PU Tubing

(P. 3-32)



Fluids: compressed air

Materials:

- Polyurethane ester
- 1 to 2 colours

Pressure: 14 bar

Temperature: -20°C to +70°C

O.D. metric: 4 mm to 8 mm

Recoil PA Tubing

(P. 3-34)



Fluids: compressed air, industrial fluids

Materials:

- Semi-rigid polyamide
- 2 colours
- Recoil tubing with fittings

Pressure: 20 bar

Temperature: -20°C to +80°C

O.D. metric: 6 mm and 8 mm

Recoil PU Tubing

(P. 3-36)



Fluids: compressed air

Materials:

- Polyurethane ester or ether
- 3 colours
- With or without fittings

Pressure: 10 bar

Temperature: -20°C to +70°C

O.D. metric: 4 mm to 12 mm

I.D. inch: 3/8" and 19/32"

Braided PU Recoil Hose

(P. 3-40)



Fluids: compressed air, industrial fluids

Materials:

- Translucent blue polyurethane, reinforced with a polyester braid
- Assembled with threaded fittings

Pressure: 15 bar

Temperature: -40°C to +75°C

I.D. inch: 1/4" and 5/16"

Braided PVC Hose

(P. 3-42)



Fluids: compressed air, non-corrosive or alimentary fluids (translucent PVC)

Materials:

- Polyvinyl chloride with braided polyester
- Translucent (food-grade) or blue (industrial)

Pressure: 15 bar

Temperature: -25°C to +70°C

I.D. metric: 4 mm to 19 mm

Self-Fastening NBR Hose

(P. 3-44)



Fluids: compressed air, coolants

Materials:

- Nitrile butadiene rubber reinforced with a polyamide braid
- 4 colours

Pressure: 16 bar

Temperature: -20°C to +100°C

I.D. inch: 1/4" to 3/4"

Technical Tubing and Hose Range

Flexible Calibrated Tubing

Polyamide Tubing

Semi-Rigid PA



1025P
1100P
2005P
2010P
Page 3-11

Rigid PA



1025L
Page 3-12

Fireproof PA



1100P..R
Page 3-15

Anti-Spark PA with PVC Sheath



1025P..V
1100P..V
Page 3-17

Polyurethane Tubing

PU Ester



1025U
1100U
2003U
2005U
2010U
Page 3-19

PU Ether PU Ether Food-Grade "Crystal"



1025U..R
1100U..R
2003U..R
2005U..R
2010U..R
Page 3-20

Antistatic PU



1025U..A
1100U..A
Page 3-23

PU Ether, Anti-Spark, Single Layer PU Ether, Anti-Spark with PVC Sheath



1025U..V
1100U..V
Page 3-25
1025U..K
1100U..K
Page 3-25

Polyethylene Tubing

Advanced PE



1015Y..F
1030Y..F
1075Y..F
1096Y..F
1098Y..F
1099Y..F
Page 3-27

Low Density PE



1100Y
Page 3-27

Fluoropolymer Tubing

FEP



1005T
1025T
Page 3-29

PFA



1010T..P
1050T..P
1100T..P
Page 3-31

Antistatic PFA



1010T..A
1050T..A
Page 3-31

Calibrated Multi-Tubing

Polyamide Tubing with PVC Sheath

Semi-Rigid PA



1010P..M
1050P..M
Page 3-33

Twin Polyurethane Tubing

Twin PU Ester



1420U
Page 3-33

Technical Tubing and Hose Range

Calibrated Recoil Tubing

Semi-Rigid Polyamide

Assembled with Fittings



1470P
1471P
1472P
Page 3-35

Polyurethane Ester and Ether Tubing

Assembled with Fittings,
Metallic Spring Guard

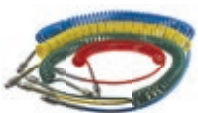

1470U
1471U
1472U
Page 3-37

Assembled with Fittings,
Plastic Spring Guard



1445U..R
1441U..R
1442U..R
1447U..R
Page 3-38

Coiled without Fittings



1460U
1461U
1462U
Page 3-37

Braided Polyurethane Hose

Assembled with Fittings,
Plastic Spring Guard



1445U..E
1442U..E
1447U..E
Page 3-41

Calibrated Braided Hose

Clear Food-Grade PVC



1025V
1050V
Page 3-43

Blue PVC



1025V..C
1050V..C
Page 3-43

Self-Fastening NBR



1040H
1080H
1100H
Page 3-45

Accessories

0694
Page 3-46



0695
Page 3-46



3000 71 11
Page 3-46



3000 71
Page 3-46



6000 71
Page 3-46



0127
Page 3-47



1827
Page 3-47



Clip
Page 3-47



0697
Page 3-47



Packaging for Technical Tubing and Hose

Tubepack®

- 5 m, 10 m, 25 m and 100 m lengths
- For polyamide, polyurethane, fluoropolymer, polyethylene and anti-spark tubing
- Optimisation of tubing storage
- Immediate identification of the type of tubing
- Integrated winder for easy handling



Drums

- Up to 1000 m long
- For polyamide, polyurethane, fluoropolymer tubing, etc.
- Immediate identification of the tubing for easy handling
- Adapted to workshop reels



Reels

- Up to 100 m
- Supplied with protective plastic film
- For braided tubing, special tubing (e.g. multi-tubing)



Plastic Bags

- Ideal for merchandising
- Promotional tools
- Recoil tubing or tubing cut to the required length



Tube Marking

- Length indicated every metre:
 - time saved when cutting to exact length
 - remaining quantity is immediately identifiable (PA and PU)
- Custom marking upon request (marking, fluid identification, customer part number...)
- Traceability with marking of manufacturing batch



How to Read the Graphs

- In the graphs in this chapter, each curve represents the acceptable maximum pressure at a given temperature, by diameter.
- Technical characteristics of Parker Legris tubing depend on the type of connection used.
- The vacuum capability of all tubing is 755 mm Hg (99% vacuum).

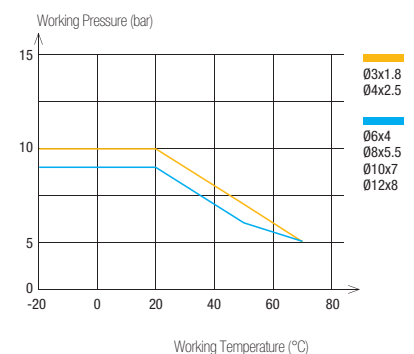

Product Codes of Parker Legris Tubing and Hose

Material

- H** = Self-Fastening NBR
- L** = Rigid Polyamide
- P** = Semi-Rigid Polyamide
- T** = Fluoropolymer
- U** = Polyurethane
- V** = PVC
- Y** = Polyethylene

Type of Tubing

- P..A** = Antistatic PA
- P..R** = Fireproof PA
- P..V** = Anti-Spark PA with PVC Sheath
- T..A** = Antistatic PFA
- T..P** = PFA
- U..A** = Antistatic PU
- U..K** = Anti-Spark Single Layer PU
- U..R** = PU Ether
- U..V** = Anti-Spark PU with PVC Sheath
- Y..F** = Advanced PE (LIQUIfit®)

2010 P 04 R 00 27

Packaging Code

1 = Tubepack® or LIQUIfit® Drum

Length

015 = 150 m
020 = 20 m
025 = 25 m
030 = 300 m
040 = 40 m
075 = 75 m
080 = 80 m
100 = 100 m

O.D. Code

03 = 3 mm
04 = 4 mm
06 = 6 mm
08 = 8 mm
 .../...
1/4 = 56 mm
 .../...

Colour

00 = ◯ clear
01 = ● black
02 = ● green
03 = ● red
04 = ● blue
05 = ● yellow
06 = ● grey
07 = ● orange
08 = ◯ crystal clear
09 = ● purple
10 = ◯ white
12 = ● crystal green
13 = ● crystal red
14 = ● crystal blue
17 = ● crystal orange

Special I.D.

18 = 1.8 mm
27 = 2.7 mm
33 = 3.3 mm
75 = 7.5 mm
95 = 9.5 mm

2 = Long Length on Drum

003 = 300 m
005 = 500 m
010 = 1000 m

10 = 10 mm
04 = 4 mm
06 = 6 mm
08 = 8 mm
10 = 10 mm
04 = 4 mm
06 = 6 mm

Tube Cutting to the Required Length

- Upon special request, customised cutting of the semi-rigid tubing (PA, PU, PE, FEP, PFA, ...)
- Cutting length from 30 mm to 14 m (+/- 2 mm precision)
- Marking upon request, in white or red
- Packaging according to customer requirements (bags/boxes/etc, ...)



PA Tubing

Tried-and-tested for industrial or vehicle applications, PA tubing guarantees **excellent durability** due to its stable long-term mechanical properties.

Parker Legris' special grade of semi-rigid polyamide is manufactured according to our **Eco-Design** approach for higher performance.

Product Advantages

Tried-&-Tested Material

- Good chemical and humidity resistance
- Excellent material stability (mechanical and chemical)
- Continuous calibration during production for excellent reliability
- Two material grades: rigid and semi-rigid
- Bio-based semi-rigid material

Versatility & Performance

- Wide range of working pressure and temperature
- Good vibration absorption
- Abrasion-resistant
- Remaining length marking
- Large choice of colours to facilitate circuit identification
- Silicone-free



Applications

- Packaging
- Tooling
- Compressed Air
- Motion Technologies
- Robotics
- Industrial Machinery

Technical Characteristics

Tubing	Semi-Rigid PA	Rigid PA
Compatible Fluids	Compressed air, other fluids	Compressed air, lubricants, other fluids
Working Pressure	Vacuum to 50 bar	Vacuum to 58 bar
Working Temperature	-40°C to +100°C	-40°C to +80°C
Component Materials	Bio-based polyamide (68 shore D)	Polyamide (65 shore D)

Regulations

Industrial

DI: 2002/95/EC (RoHS), 2011/65/EC
 DI: 97/23/EC (PED)
 RG: 1907/2006 (REACH)

Transportation

Chemical performance and resistance tested according to
 DIN 74324 -1 / DIN 73378 / ISO 7628

Packaging

Tube pack: 25 m, 100 m
 Drum: 500 m, 1000 m

Reliable performance is dependent upon the type of fluid conveyed and fittings being used. Use is guaranteed with a vacuum of 755 mm Hg (99% vacuum).

Performance of PA Tubing

Semi-Rigid

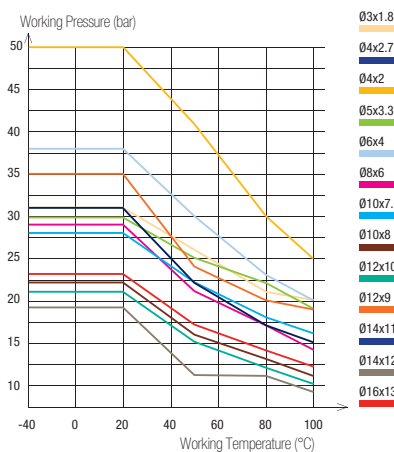

Rigid

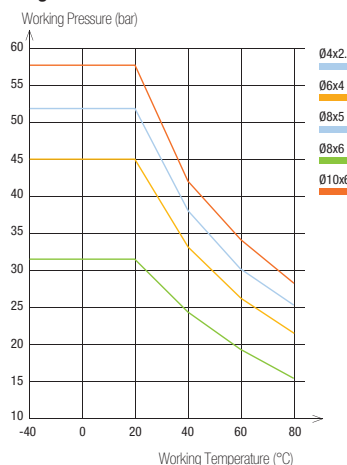









Tube O.D.	Tube O.D. Tolerance
3 to 5 mm	+0.05 / -0.08
6 to 16 mm	+0.05 / -0.10

Connected to Parker Legris push-in fittings, the calibration of Parker Legris tubing ensures perfect sealing in accordance with NF E49-100.

1025P

Semi-Rigid Polyamide (PA) Tubing

Tubepack® 25 m









Ø ext. (mm)	Ø int. (mm)									kg
3	1.8	6	1025P03 00 18				1025P03 04 18			0.200
4	2	10	1025P04 00	1025P04 01	1025P04 02	1025P04 03	1025P04 04	1025P04 05	1025P04 06	0.318
	2.7	10	1025P04 00 27	1025P04 01 27	1025P04 02 27	1025P04 03 27	1025P04 04 27	1025P04 05 27	1025P04 06 27	0.254
5	3.3	15	1025P05 00 33	1025P05 01 33			1025P05 04 33			0.420
6	4	15	1025P06 00	1025P06 01	1025P06 02	1025P06 03	1025P06 04	1025P06 05	1025P06 06	0.535
8	6	25	1025P08 00	1025P08 01	1025P08 02	1025P08 03	1025P08 04	1025P08 05	1025P08 06	0.748
10	7.5	42	1025P10 00 75	1025P10 01 75			1025P10 04 75			1.135
	8	50	1025P10 00	1025P10 01	1025P10 02	1025P10 03	1025P10 04	1025P10 05	1025P10 06	0.989
12	9	47	1025P12 00 09	1025P12 01 09			1025P12 04 09			1.769
	10	90	1025P12 00	1025P12 01			1025P12 04	1025P12 05		1.345
14	11	80	1025P14 00 11	1025P14 01 11			1025P14 04 11			2.226
	12	116	1025P14 00	1025P14 01			1025P14 04			1.734
16	13	90	1025P16 00 13	1025P16 01 13	1025P16 02 13	1025P16 03 13	1025P16 04 13			2.500

Inch version tubing available upon request

1100P

Semi-Rigid Polyamide (PA) Tubing

Tubepack® 100 m









Ø ext. (mm)	Ø int. (mm)									kg
4	2	10	1100P04 00	1100P04 01	1100P04 02	1100P04 03	1100P04 04	1100P04 05	1100P04 06	1.152
	2.7	10	1100P04 00 27	1100P04 01 27	1100P04 02 27	1100P04 03 27	1100P04 04 27	1100P04 05 27	1100P04 06 27	0.893
5	3.3	15	1100P05 00 33	1100P05 01 33			1100P05 04 33			1.274
6	4	15	1100P06 00	1100P06 01	1100P06 02	1100P06 03	1100P06 04	1100P06 05	1100P06 06	1.799
8	6	25	1100P08 00	1100P08 01	1100P08 02	1100P08 03	1100P08 04	1100P08 05	1100P08 06	2.898
10	7.5	42	1100P10 00 75	1100P10 01 75			1100P10 04 75			4.400
	8	50	1100P10 00	1100P10 01	1100P10 02	1100P10 03	1100P10 04	1100P10 05		3.667
12	9	47	1100P12 00 09	1100P12 01 09			1100P12 04 09			5.600
	10	90	1100P12 00	1100P12 01			1100P12 04		1100P12 06	5.052
14	11	80	1100P14 00 11	1100P14 01 11			1100P14 04 11			5.200
	12	116	1100P14 00	1100P14 01			1100P14 04			4.800
16	13	90	1100P16 00 13	1100P16 01 13	1100P16 02 13	1100P16 03 13	1100P16 04 13			7.800

Inch versions: also available

2005P

Semi-Rigid Polyamide (PA) Tubing









Drum 500 m

Ø ext. (mm)	Ø int. (mm)									kg
8	6	25	2005P08 00	2005P08 01	2005P08 02	2005P08 03	2005P08 04	2005P08 05	2005P08 06	12.100
10	8	50	2005P10 00	2005P10 01	2005P10 02	2005P10 03	2005P10 04	2005P10 05		15.600

2010P

Semi-Rigid Polyamide (PA) Tubing

Drum 1000 m

Ø ext. (mm)	Ø int. (mm)									kg
4	2.7	10	2010P04 00 27	2010P04 01 27	2010P04 02 27	2010P04 03 27	2010P04 04 27	2010P04 05 27	2010P04 06 27	7.630
6	4	15	2010P06 00	2010P06 01	2010P06 02	2010P06 03	2010P06 04	2010P06 05	2010P06 06	16.600

Tube Cutting to the Required Length

- Upon special request, customised cutting of the semi-rigid tubing (PA, PU, PE, FEP, PFA, ...)
- Cutting length from 30 mm to 14 m (+/- 2 mm precision)
- Marking upon request, in white or red
- Packaging according to customer requirements (bags/boxes/etc, ...)





PA Tubing

1025L

Rigid Polyamide (PA) Tubing

Tubepack® 25 m

Ø ext. (mm)	Ø int. (mm)	 R		kg
4	2.5	35	1025L04 01 25	0.190
6	4	45	1025L06 01	0.400
8	5	70	1025L08 01 05	0.760
	6	65	1025L08 01	0.760
10	6	85	1025L10 01 06	1.330

PA tubing can be connected to various fittings shown throughout this catalogue.

Tubing

Semi-Rigid PA



Rigid PA



Push-In Fittings

[LF 3000®](#) P. 1-4



[LF 3600](#) P. 1-95



[LF 3800/LF 3900](#) P. 1-113



[LF 6100](#) P. 1-107



Compression Fittings

[Brass](#) P. 5-5



[Stainless Steel](#) P. 5-31



[Ferrules](#) P. 5-5





Flexible Calibrated Tubing

Technical Tubing
and Hose

Fireproof High Resistance PA Tubing

This **single layer fireproof** tubing not only combines excellent resistance to pressure, temperature and flame, but also guarantees **non-toxic smoke** resulting from burn-off. This tubing eliminates the need for a stripping tool, thus preventing the risk of tube damage prior to connection.

Product Advantages

Safety for On-Board Railway Equipment

- Designed for on-board equipment
- Excellent flame resistance: self-extinguishing
- Very little smoke generation
- Non-toxic combustion gases
- UV-resistant
- Extremely resistant to high pressure and temperature

Innovative Single-Layer Solution

- Developed for demanding industrial applications
- Excellent spark resistance
- Economical alternative to PA tubing with PVC sheath
- Combines technical advantages of rigid and semi-rigid PA tubing
- 5 colours available
- Flow direction marking
- Silicone-free



Applications

- Railway
- Air Horns
- Industrial Machinery
- Pneumatic Doors
- Step-Units
- Centralised Lubrication
- Welding

Technical Characteristics

Compatible Fluids	Compressed air, lubricants Other fluids: please consult us
Working Pressure	Vacuum to 50 bar
Working Temperature	-40°C to +100°C
Component Materials	Polyamide (63 shore D)

Regulations

Railway
Pr EN 45545-2: HL3, R22, R24, R25
NF F16101: I3 F2,
DIN 5510-2: S4, SR2, ST2
ISO 4892

Industrial
DI: 97/23/EC (PED)
DI: 2002/95/EC (RoHS), 2011/65/EC
RG: 1907/2006/EC (REACH)
UL94 V-0 (Fire resistance)

Reliable performance is dependent upon the type of fluid conveyed and fittings being used. Use is guaranteed with a vacuum of 755 mm Hg (99% vacuum).

Performance of Fireproof High Resistance PA Tubing

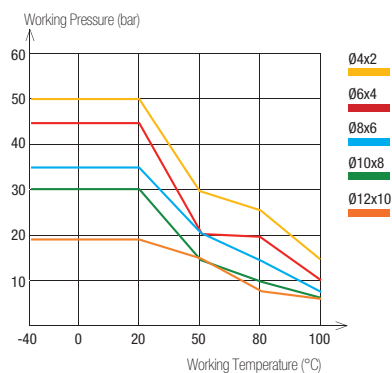

Tube O.D.	Tube O.D. Tolerance
4 mm	+0.05 / -0.08
6 to 12 mm	+0.05 / -0.10

Packaging
Tubepack*: 100 m





Connected to Parker Legris push-in fittings, the calibration of PA tubing ensures perfect sealing based on NF E49-100.

To calculate burst pressure, the values in this graph should be multiplied by 3.

1100P..R

Fireproof High Resistant Polyamide (PA) Tubing

Tubepack® 100 m

Ø ext. (mm)	Ø int. (mm)		 clear			kg
4	2	17	1100P04R00	1100P04R01	1100P04R04	1.308
6	4	29	1100P06R00	1100P06R01	1100P06R04	1.308
8	6	40	1100P08R00	1100P08R01	1100P08R04	2.122
10	8	77	1100P10R00	1100P10R01	1100P10R04	2.725
12	10	92	1100P12R00	1100P12R01	1100P12R04	3.716

Other colours available on request with a minimum order quantity: for diameters 4 to 6 mm, 1000 m; for 8 mm, 500 m; for diameters 10 to 12 mm, 300 m.

Flexible Calibrated Tubing

Technical Tubing
and Hose

Related Products

Fireproof high resistance tubing can be connected to various fittings presented in Chapters 1 and 5.

Push-In Fittings

[LF 3000®](#)
P. 1-4

[LF 3600](#)
P. 1-95

[LF 3800/LF 3900](#)
P. 1-113

[LF 6100](#)
P. 1-107



Compression Fittings

[Brass](#)
P. 5-5

[Brass Tube Support](#)
P. 5-5



Anti-Spark PA Tubing with PVC Sheath

A range of **flame and spark-resistant** PA tubing with superior resistance to impact and abrasion, improving equipment **durability**, particularly in areas subject to weld spatter.

Product Advantages

Spark Resistance | Flame-retardant PVC jacket protects inner tubing
Non-adhesive jacket facilitates sheath removal
Excellent pressure resistance at high temperature

Robustness & Durability | Highly kink and crush-resistant
Excellent compatibility with coolants
Flow direction marking
Silicone-free



Industrial Machinery
Welding Robots
Cooling
Aggressive Environments

Applications

Technical Characteristics

Compatible Fluids	Hot and cold water, refrigerated fluids, compressed air
Working Pressure	0 to 36 bar
Working Temperature	-20°C to +80°C
Component Materials	Polyamide & PVC Sheath

Regulations

Industrial
DI: 2002/95/EC (RoHS), 2011/65/EC
DI: 97/23/EC (PED)
RG: 1907/2006 (REACH)
UL94 V-0 (Fire resistance)

Packaging

Tube-pack*: 25 m, 100 m

Reliable performance is dependent upon the type of fluid conveyed and fittings being used.

Performance of Anti-Spark PA Tubing with PVC Sheath

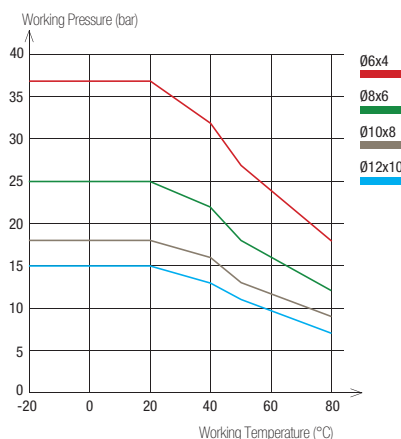

To calculate burst pressure, the values in this graph should be multiplied by 3.

O.D.	Tube O.D. Tolerance	PVC Sheath Thickness
PVC Sheath 8 to 14 mm	+0.10 / -0.10	1 mm
Inner Tubing 6 to 12 mm	+0.05 / -0.10	

Connected to Parker Legris push-in fittings, the calibration of PA tubing ensures perfect sealing based on NF E49-100 (semi-rigid PA inner tubing).





Tube O.D.	Sheath Removal Length for LF 3600 Push-In Fittings (mm)
4 mm	15± 1
6 mm	18± 1
8 mm	19± 1
10 mm	24± 1
12 mm	25± 1

For other fitting ranges, please consult us.

1025P..V

Anti-Spark Polyamide (PA) Tubing





Tubepack® 25 m

Ø ext. (mm)	Ø int. (mm)					kg
6	4	25	1025P06V01	1025P06V03	1025P06V04	1,238
8	6	30	1025P08V01	1025P08V03	1025P08V04	1,693
10	8	55	1025P10V01	1025P10V03	1025P10V04	2,029
12	10	70	1025P12V01		1025P12V04	2,970

1100P..V

Anti-Spark Polyamide (PA) Tubing

Tubepack® 100 m

Ø ext. (mm)	Ø int. (mm)					kg
6	4	25	1100P06V01	1100P06V03	1100P06V04	2,338
8	6	30	1100P08V01	1100P08V03	1100P08V04	3,767
10	8	55	1100P10V01	1100P10V03	1100P10V04	4,767
12	10	70	1100P12V01		1100P12V04	6,567

6000 71 00

Stripping Tool for Anti-Spark Tubing

Technical polymer, stainless steel



6000 71 00

kg

0.098

**Working Principle**

Stripping Tool 6000 71 00



1. Place tube in stripping tool to adjust the blade height to the tube thickness.



2. Blade height is adjusted using the wheel at the bottom of the handle.

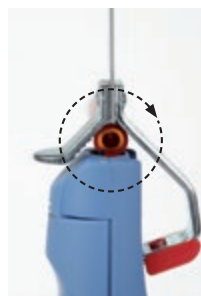

3. Once adjustments have been made, perform a 360° rotation around the tube with the tool.

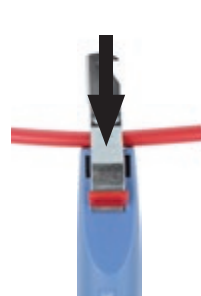

4. Push down firmly on the metal part of the tool in order to hold tube properly.



5. Move the tool to the end of the tube to create an axial opening of the sheath.



6. The tube is correctly stripped.

PU Tubing

Polyurethane's **3 specific materials** - ether, ester and food-grade "crystal" - offer excellent flexibility and outstanding use in a wide range of applications, allowing for up to **50% space reduction** when compared to semi-rigid PA tubing.

Product Advantages

Excellent Mechanical Properties

- Consistent tensile strength for optimum longevity
- Optimal bend radius
- Good vibration absorption
- Unsurpassed abrasion resistance for a single layer tubing
- UV-resistant
- Superior vacuum capability due to surface hardness
- Remaining length marking
- Silicone-free

3 Material Grades

- PU ester: perfect for pneumatic applications
- PU ether: no water absorption ; superior chemical resistance to PU ester
- PU ether food-grade "crystal":
 - identification of fluids and circuits
 - chemical resistance superior to PU ether
 - improved longevity



Applications

- Food Process
- Robotics
- Cabling
- Pneumatics
- Automation
- In-Plant Automotive
- Rapid Cycles

Technical Characteristics

Compatible Fluids	Compressed air, industrial fluids (depending on the material type)
Working Pressure	Vacuum to 12 bar
Working Temperature	-20°C to +70°C
Component Materials	Polyurethane ester (52 Shore D) Polyurethane ether (52 Shore D) Polyurethane ether food-grade "crystal" (52 Shore D)

Regulations

Industrial

- DI: 2002/95/EC (RoHS), 2011/65/EC
- DI: 97/23/EC (PED)
- RG: 1907/2006 (REACH)

Food (PU ether food-grade "crystal")

- FDA: 21 CFR 177.2600, 178.3297, 176.170, 178.2010
- RG: 1935/2004 EC

Reliable performance is dependent upon the type of fluid conveyed and fittings being used. Use is guaranteed with a vacuum of 755 mm Hg (99% vacuum).

Performance of PU Tubing

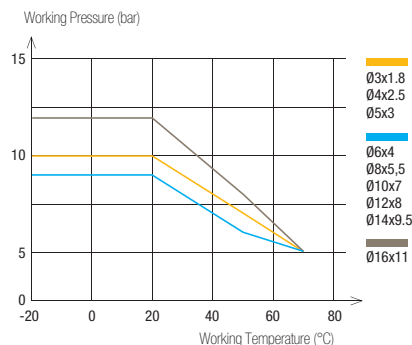

To calculate burst pressure, the values in this graph should be multiplied by 3.

Tube O.D.	Tube O.D. Tolerance
3 to 8 mm	+0.10 / -0.10
10 to 16 mm	+0.15 / -0.15

Connected to Parker Legris push-in fittings, the calibration of PU tubing ensures perfect sealing based on NF E49-101.







Packaging

- Tube pack: 25 m, 100 m
- Drum: 300 m, 500 m, 1000 m

1025U

Polyurethane (PU) Ester Tubing

Tubepack® 25 m







Ø ext. (mm)	Ø int. (mm)								kg
3	1.8	8	1025U03 01 18						0.020
4	2.5	10	1025U04 01	1025U04 02	1025U04 03	1025U04 04	1025U04 05	1025U04 06	0.310
5	3	13	1025U05 01			1025U05 04			0.522
6	4	15	1025U06 01	1025U06 02	1025U06 03	1025U06 04	1025U06 05	1025U06 06	0.591
8	5.5	20	1025U08 01	1025U08 02	1025U08 03	1025U08 04	1025U08 05	1025U08 06	0.971
10	7	25	1025U10 01	1025U10 02		1025U10 04	1025U10 05	1025U10 06	1.467
12	8	35	1025U12 01	1025U12 02		1025U12 04	1025U12 05	1025U12 06	2.406
14	9.5	45	1025U14 01 95			1025U14 04 95			2.815
16	11	45	1025U16 01 11	1025U16 02 11	1025U16 03 11	1025U16 04 11			2.815

Inch tubing available upon request

1100U

Polyurethane (PU) Ester Tubing

Tubepack® 100 m







Ø ext. (mm)	Ø int. (mm)								kg
4	2.5	10	1100U04 01	1100U04 02	1100U04 03	1100U04 04	1100U04 05	1100U04 06	1.092
5	3	13	1100U05 01			1100U05 04			1.092
6	4	15	1100U06 01	1100U06 02	1100U06 03	1100U06 04	1100U06 05	1100U06 06	2.064
8	5.5	20	1100U08 01	1100U08 02	1100U08 03	1100U08 04	1100U08 05	1100U08 06	3.610
10	7	25	1100U10 01			1100U10 04			6.105
12	8	35	1100U12 01			1100U12 04			8.610
14	9.5	45	1100U14 01 95			1100U14 04 95			11.215
16	11	45	1100U16 01 11	1100U16 02 11	1100U16 03 11	1100U16 04 11			12.176

Inch tubing available upon request

2003U

Polyurethane (PU) Ester Tubing







Drum 300 m

Ø ext. (mm)	Ø int. (mm)								kg
10	7	25	2003U10 01	2003U10 02	2003U10 03	2003U10 04	2003U10 05	2003U10 06	16.600

2005U

Polyurethane (PU) Ester Tubing







Drum 500 m

Ø ext. (mm)	Ø int. (mm)								kg
8	5.5	20	2005U08 01	2005U08 02	2005U08 03	2005U08 04	2005U08 05		17.100

2010U









Polyurethane (PU) Ester Tubing

Drum 1000 m

Ø ext. (mm)	Ø int. (mm)								kg
4	2.5	12	2010U04 01	2010U04 02	2010U04 03	2010U04 04	2010U04 05	2010U04 06	9.840
6	4	15	2010U06 01	2010U06 02	2010U06 03	2010U06 04	2010U06 05	2010U06 06	20.460









1025U..R Polyurethane (PU) Ether Tubing

Tubepack® 25 m

Ø ext. (mm)	Ø int. (mm)									kg
4	2.5	12	1025U04R01	1025U04R04	1025U04R08	1025U04R12	1025U04R13	1025U04R14	1025U04R17	0.310
5	3	13			1025U05R08					0.522
6	4	15	1025U06R01	1025U06R04	1025U06R08	1025U06R12	1025U06R13	1025U06R14	1025U06R17	0.591
8	5.5	20	1025U08R01	1025U08R04	1025U08R08	1025U08R12	1025U08R13	1025U08R14	1025U08R17	0.971
10	7	25	1025U10R01	1025U10R04	1025U10R08			1025U10R14		1.467
12	8	35	1025U12R01	1025U12R04	1025U12R08			1025U12R14		2.406
14	9.5	45		1025U14R01 95						2.421
16	11	45			1025U16R08 11					2.815



1100U..R Polyurethane (PU) Ether Tubing

Tubepack® 100 m

Ø ext. (mm)	Ø int. (mm)									kg
4	2.5	12	1100U04R01	1100U04R04	1100U04R08	1100U04R12	1100U04R13	1100U04R14	1100U04R17	1.092
6	4	15	1100U06R01	1100U06R04	1100U06R08	1100U06R12	1100U06R13	1100U06R14	1100U06R17	2.064
8	5.5	20	1100U08R01	1100U08R04	1100U08R08	1100U08R12	1100U08R13	1100U08R14	1100U08R17	3.610
10	7	25			1100U10R08			1100U10R14		6.109
12	8	35			1100U12R04					8.610
14	9.5	45			1100U14R08 95					11.215
16	11	45			1100U16R08 11					12.176

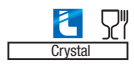

2003U..R Polyurethane (PU) Ether Tubing

Drum 300 m

Ø ext. (mm)	Ø int. (mm)					kg
10	7	25	2003U10R01	2003U10R04	2003U10R08	16.600



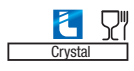

2005U..R Polyurethane (PU) Ether Tubing

Drum 500 m

Ø ext. (mm)	Ø int. (mm)					kg
8	5.5	20	2005U08R01	2005U08R04	2005U08R08	15.600

2010U..R Polyurethane (PU) Ether Tubing

Drum 1000 m

Ø ext. (mm)	Ø int. (mm)					kg
4	2.5	12	2010U04R01	2010U04R04	2010U04R08	8.670
6	4	15	2010U06R01	2010U06R04	2010U06R08	18.600



Flexible Calibrated Tubing

Technical Tubing
and Hose

Antistatic PU Tubing

With a constant **10² Ω.m resistivity** across the entire thickness of the tubing wall, this tubing guarantees **perfect dissipation of accumulated static electricity**, thereby increasing safety.

Product Advantages

Security

- Low resistivity throughout the material
- Suitable for ATEX* areas
- Superior longevity
- Excellent vibration absorption
- UV-resistant
- Silicone-free

Machinery Optimisation

- Minimum bend radius allowing maximum space saving
- Good chemical resistance
- Wide temperature range
- Stable chemical characteristics throughout tubing



Antistatic Packaging
Pneumatics
Electronics
Spray Painting
Electrical Converters

Applications

Technical Characteristics

Compatible Fluids	Compressed air, industrial fluids
Working Pressure	Vacuum to 10 bar
Working Temperature	-20°C to +70°C
Component Materials	Polyurethane with conductive additive (50 shore D)

Regulations

DI: 94/9/EC (ATEX*)
DI: 1907/2006 (REACH)
DI: 2002/95/EC (RoHS), 2011/65/EC
*For ATEX areas, please consult us

Reliable performance is dependent upon the type of fluid conveyed and fittings being used. Use is guaranteed with a vacuum of 755 mm Hg (99% vacuum).

Performance of Antistatic PU Tubing

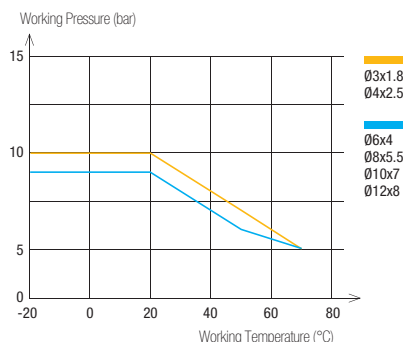

To calculate burst pressure, the values in this graph should be multiplied by 3.

Tube O.D.	Tube O.D. Tolerance
3 to 8 mm	+0.10 / -0.10
10 to 12 mm	+0.15 / -0.15



Connected to Parker Legris push-in fittings, the calibration of Parker Legris tubing ensures perfect sealing based on NF E49-101.

Packaging

Tube pack*: 25 m, 100 m



1025U..A Anti-Static Polyurethane (PU) Ester Tubing

Tubepack® 25 m

Ø ext. (mm)	Ø int. (mm)			kg
4	2.5	12	1025U04A01	0.260
6	4	15	1025U06A01	0.500
8	5.5	25	1025U08A01	1.260

1100U..A Anti-Static Polyurethane (PU) Ester Tubing

Tubepack® 100 m

Ø ext. (mm)	Ø int. (mm)			kg
3	1.8	10	1100U03A01	0.836
4	2.5	12	1100U04A01	1.092
6	4	15	1100U06A01	2.064
8	5.5	25	1100U08A01	3.610
10	7	35	1100U10A01	6.105
12	8	45	1100U12A01	8.610

Flexible Calibrated Tubing

Technical Tubing
and Hose

Related Products

To maintain the antistatic properties throughout the circuit, it is recommended that this tubing be used with metallic fittings.

Push-In Fittings

[LF 3600](#) P. 1-95



[LF 3800](#) P. 1-113



[LF 3900](#) P. 1-113



Compression Fittings

[Brass](#) P. 5-5



[Stainless Steel](#) P. 5-31



Anti-Spark PU Tubing

Combining **outstanding spark resistance** with superb **flexibility**, this range is perfectly suited for welding applications.

Two types of PU - ether with PVC sheath or single layer ether - are available and allow **rapid installation** with Parker Legris push-in fittings.

Product Advantages

PU with PVC Sheath

- High resistance to kinking and abrasion
- Non-adhesive jacket facilitating sheath removal
- Fluid direction marking
- Self-extinguishing sheath, protecting the inner tubing
- Silicone-free

Single Layer PU

- Minimum bend radius for maximum space saving
- Significant flexibility for rapid cycling
- Good chemical resistance
- Flow direction marking
- Fireproof material
- Silicone-free



- Applications
- Industrial Machinery
 - Compressed Air
 - Robotics
 - Mechanical Constraints
 - Cooling
 - Welding
 - Cabling

Technical Characteristics

Compatible Fluids	Industrial fluids, compressed air, coolants
Working Pressure	Vacuum to 14 bar
Working Temperature	-20°C to +70°C
Component Materials	PU ether with PVC sheath PU ether single layer

O.D. of Tube	Sheath Removal Length for LF 3600 (mm)
4 mm	15± 1
6 mm	18± 1
8 mm	19± 1
10 mm	24± 1
12 mm	25± 1

Regulations

UL94 V-0 (Fire resistance)
 DI: 2002/95/EC (RoHS),
 2011/65/EC
 RG: 1907/2006 (REACH)

Packaging

Tube pack*: 25 m, 100 m

Reliable performance is dependent upon the type of fluid conveyed and fittings being used. Use is guaranteed with a vacuum of 755 mm Hg (99% vacuum).

For other fitting ranges or other tube diameters, please consult us.

Tubing Performance

Anti-Spark PU Tubing, with PVC Sheath

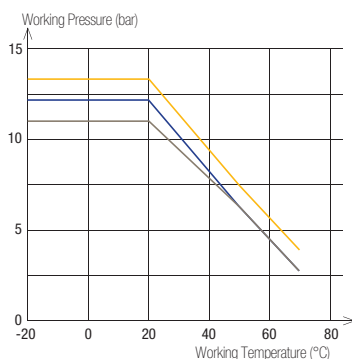

Anti-Spark PU Tubing, Single Layer

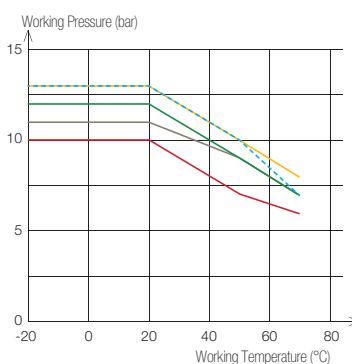





To calculate burst pressure, the values in these graphs should be multiplied by 3.
 For diameter 14x9.5: tubing performances available upon request.





Tube O.D.	Tube O.D. Tolerance	Thickness and Tolerances of PVC Sheath
4 to 8 mm	+0.10 / -0.10	1mm +0.10 / -0.10
10 to 14 mm	+0.15 / -0.15	

Connected to Parker Legris push-in fittings, the calibration of Parker Legris tubing ensures perfect sealing based on NF E49-101 (inner tubing for sheathed or single layer tubing).





1025U..V Anti-Spark Sheath Polyurethane (PU) Ether Tubing Tubepack® 25 m

Ø ext. (mm)	Ø int. (mm)					kg
6	4	12	1025U06V01	1025U06V03	1025U06V04	1.200
8	5.5	20	1025U08V01	1025U08V03	1025U08V04	1.620
10	7	25	1025U10V01	1025U10V03	1025U10V04	2.900
12	8	35	1025U12V01		1025U12V04	4.030





1100U..V Anti-Spark Sheath Polyurethane (PU) Ether Tubing Tubepack® 100 m

Ø ext. (mm)	Ø int. (mm)					kg
6	4	12	1100U06V01	1100U06V03	1100U06V04	5.370
8	5.5	20	1100U08V01	1100U08V03	1100U08V04	7.630
10	7	25	1100U10V01	1100U10V03	1100U10V04	10.860
12	8	35	1100U12V01		1100U12V04	15.060

1025U..K Single Layer Anti-Spark Polyurethane (PU) Ether Tubing Tubepack® 25 m

Ø ext. (mm)	Ø int. (mm)						kg
4	2.5	12	1025U04K01		1025U04K03		0.230
6	4	15	1025U06K01		1025U06K03	1025U06K04	0.580
8	5.5	20	1025U08K01	1025U08K02	1025U08K03	1025U08K04	0.860
10	7	25	1025U10K01	1025U10K02	1025U10K03	1025U10K04	1.230
12	8	35	1025U12K01	1025U12K02	1025U12K03	1025U12K04	2.080
14	9.5	45			1025U14K03 95		2.620

1100U..K Single Layer Anti-Spark Polyurethane (PU) Ether Tubing Tubepack® 100 m

Ø ext. (mm)	Ø int. (mm)						kg
4	2.5	12	1100U04K01				0.900
6	4	15	1100U06K01		1100U06K03	1100U06K04	2.320
8	5.5	20	1100U08K01	1100U08K02	1100U08K03	1100U08K04	3.030
10	7	25	1100U10K01	1100U10K02	1100U10K03	1100U10K04	5.100
12	8	35	1100U12K01	1100U12K02	1100U12K03	1100U12K04	8.600
14	9.5	45			1100U14K03 95		10.676

6000 71 00 Stripping Tool for Anti-Spark Tubing

Technical polymer, stainless steel

[6000 71 00](#)

kg

0.098

Working principle of the stripping tool page 3-17



PE Tubing

Parker Legris offers two types of polyethylene tubing: "**Advanced PE**" 50% reticulated and **Low Density PE**. Our range of "Advanced PE" is designed for demanding environments, especially that of water treatment, without compromising operator **safety**.

Product Advantages

Advanced PE

- 50% reticulated material
- Best balance between flexibility and pressure/temperature resistance
- Resistant to a wide range of aggressive chemicals
- UV-stabilised: ideal for outdoor applications
- Approved for permanent contact with food and beverages
- Silicone-free

Low Density PE

- Excellent resistance to aggressive and corrosive agents
- Good technical trade-off
- Food-grade material
- Silicone-free



Applications

- Beverage
- Chemical
- Petrochemical
- Food Process
- Water
- Water Treatment

Technical Characteristics

Tube	Advanced PE	Low Density PE
Compatible Fluids	Water, beverages and other fluids	Industrial fluids
Working Pressure	Vacuum to 16 bar	Vacuum to 20 bar
Working Temperature	-40°C to +95°C	-40°C to +60°C
Component Materials	High quality polyethylene: 50% reticulated PE 50% low density PE (44 shore D)	Low Density Polyethylene (44 shore D)

Regulations

Advanced PE Tubing

FDA: 21 CFR 177.1520
 RG: 1935/2004/EC
 DI: 97/23/EC (PED)
 DI: 2002/95/EC (RoHS), 2011/65/EC
 NSF 42/58 (1/4" and 3/8" approved for 10 bar and 1/2" approved for 8 bar at room temperature)
 NSF 51, 61 C-HOT
 ACS (except for purple colour)
 WRAS
 RG: 1907/2006 (REACH)

Low Density PE Tubing

FDA: 21 CFR 177.1520
 DI: 2002/95/EC (RoHS), 2011/65/EC
 DI: 97/23/EC (PED)

Reliable performance is dependent upon the type of fluid conveyed and fittings being used. Use is guaranteed with a vacuum of 755 mm Hg (99% vacuum).

Tubing Performance

Advanced PE Tubing

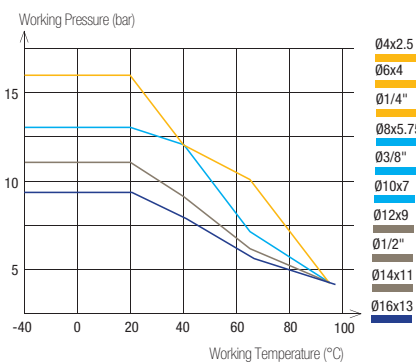

Low Density PE Tubing

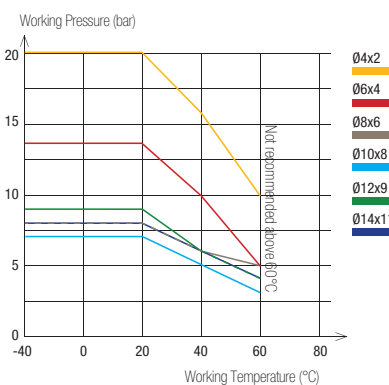

Tube O.D.	Tube O.D. Tolerance
1/4" to 1/2"	+0.10 / -0.10
4 to 16 mm	+0.10 / -0.10

Connected to Parker Legris push-in fittings, the calibration of Parker Legris tubing ensures perfect sealing.









Packaging

Advanced PE Tubing
 Drum: 75 m, 150 m, 300 m
 250 feet, 500 feet, 1 000 feet
 PE Tubing
 Tubepack: 25 m, 100 m

1015Y..F

Advanced Polyethylene (APE) Tubing









Drum 150 m

Ø ext. (mm)	Ø int. (mm)		 clear						 white	kg
4	2.5	16	1015Y04F00	1015Y04F01	1015Y04F02	1015Y04F03	1015Y04F04	1015Y04F05	1015Y04F10	4.914
6	4	32	1015Y06F00	1015Y06F01	1015Y06F02	1015Y06F03	1015Y06F04	1015Y06F05	1015Y06F10	5.434
8	5.75	40	1015Y08F00	1015Y08F01	1015Y08F02	1015Y08F03	1015Y08F04	1015Y08F05	1015Y08F10	3.279
10	7	40	1015Y10F00	1015Y10F01	1015Y10F02	1015Y10F03	1015Y10F04	1015Y10F05	1015Y10F10	5.318

1030Y..F

Advanced Polyethylene (APE) Tubing









Drum 300 m

Ø ext. (mm)	Ø int. (mm)		 clear						 white	kg
4	2.5	16	1030Y04F00	1030Y04F01	1030Y04F02	1030Y04F03	1030Y04F04	1030Y04F05	1030Y04F10	2.860
6	4	32	1030Y06F00	1030Y06F01	1030Y06F02	1030Y06F03	1030Y06F04	1030Y06F05	1030Y06F10	5.318

1075Y..F

Advanced Polyethylene (APE) Tubing









Drum 75 m

Ø ext. (mm)	Ø int. (mm)		 clear						 white	kg
12	9	55	1075Y12F00	1075Y12F01	1075Y12F02	1075Y12F03	1075Y12F04	1075Y12F05	1075Y12F10	3.852
14	11	75	1075Y14F00							5.850
16	13	95	1075Y16F01							7.550

1096Y..F

Advanced Polyethylene (APE) Tubing









Drum 250 ft

Ø ext. (mm)	Ø int. (mm)		 clear						 white	kg
1/2	0.375	1.96	1096Y62F00	1096Y62F01	1096Y62F02	1096Y62F03	1096Y62F04	1096Y62F05	1096Y62F10	4.200

1098Y..F

Advanced Polyethylene (APE) Tubing









Drum 500 ft

Ø ext. (mm)	Ø int. (mm)		 clear						 white	kg
1/4	0.170	0.78	1098Y56F00	1098Y56F01	1098Y56F02	1098Y56F03	1098Y56F04	1098Y56F05	1098Y56F10	2.334
3/8	0.250	1.18	1098Y60F00	1098Y60F01	1098Y60F02	1098Y60F03	1098Y60F04	1098Y60F05	1098Y60F10	5.518

1099Y..F

Advanced Polyethylene (APE) Tubing



Drum 1000 ft

Ø ext. (mm)	Ø int. (mm)		 clear						 white	kg
1/4	0.170	0.78	1099Y56F00	1099Y56F01	1099Y56F02	1099Y56F03	1099Y56F04	1099Y56F05	1099Y56F10	4.718

Low Density Polyethylene

1100Y

Tubepack® 100 m

Ø ext. (mm)	Ø int. (mm)		 clear	kg
4	2	25	1100Y04 00	0.910
6	4	35	1100Y06 00	1.500
8	6	55	1100Y08 00	2.140
10	8	80	1100Y10 00	2.710
12	9	65	1100Y12 00	4.750
14	11	80	1100Y14 00	5.650

Fluoropolymer Tubing – FEP

FEP (fluorinated ethylene propylene) tubing is a **robust engineering fluoropolymer** which provides excellent fluid visibility and is perfect for flow control monitoring.

Product Advantages

Flow Control | Transparent
Flexible and non-flammable material
Resistant to nearly all chemicals and solvents

Tried-&-Tested Properties | Excellent transmission of UV light
Low friction coefficient
Food-grade material
Low permeability
Easily weldable
Silicone-free



Instrumentation
Food Process
UV
Gas Sampling
Chemical
Temperature Cycling
Laboratory

Applications

Technical Characteristics

Compatible Fluids	Industrial fluids
Working Pressure	0 to 28 bar
Working Temperature	-40°C to +150°C
Component Materials	Fluorinated ethylene propylene (pure) (55 Shore D)

Regulations

Food
FDA: 21 CFR 177.1550
RG: 1935/2004

Industrial
UL94 V-0 (Fire resistance)
DI: 2002/95/EC (RoHS), 2011/65/EC
DI: 97/23/EC (PED)
RG: 1907/2006 (REACH)

Reliable performance is dependent upon the type of fluid conveyed and fittings being used.

Performance of FEP Tubing

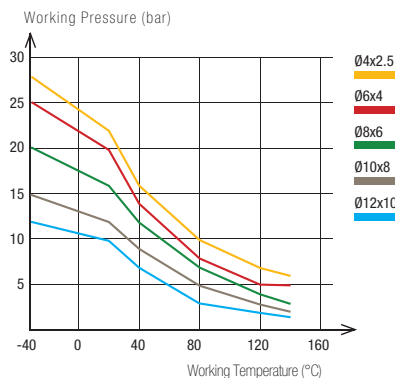

Tube O.D.	Tube O.D. Tolerance
4 mm	+0.05 / -0.05
6 to 10 mm	+0.07 / -0.07
12 mm	+0.10 / -0.10



Packaging
Tubepack®: 5 m, 25 m

Connected to Parker Legris push-in fittings, the calibration of Parker Legris tubing ensures perfect sealing.

1005T

Fluoropolymer (FEP) Tubing



Tubepack® 5 m

Ø ext. (mm)	Ø int. (mm)		 clear	kg
4	2.5	40	1005T04 00 25	0.155
6	4	50	1005T06 00	0.250
8	6	70	1005T08 00	0.385
10	8	120	1005T10 00	0.524
12	10	180	1005T12 00	0.547

1025T

Fluoropolymer (FEP) Tubing

Tubepack® 25 m

Ø ext. (mm)	Ø int. (mm)		 clear	kg
4	2.5	40	1025T04 00 25	0.506
6	4	50	1025T06 00	1.025
8	6	70	1025T08 00	1.431
10	8	120	1025T10 00	1.693
12	10	180	1025T12 00	1.913

Flexible Calibrated Tubing

Technical Tubing
and Hose

Related Products

Parker Legris stainless steel fittings are perfectly suited for use with fluoropolymer tubing (PFA, FEP).

Push-In Fittings

[LF 3800](#) P. 1-77



[LF 3900](#) P. 1-77



Compression Fittings

[Stainless Steel](#) P. 5-31



Fluoropolymer Tubing - PFA

Parker Legris **PFA** (perfluoroalkoxy) tubing offers **10 times greater durability** than other fluoropolymer tubings (PTFE, FEP and PVDF) under severe chemical and mechanical conditions. This tubing range is available in **three material grades**, offering perfect compatibility with all applications, even in extreme environments.

Product Advantages

Great Versatility

- Exceptional chemical inertia
- A flexible alternative to stainless steel tubing
- Broad range of working temperatures, from cryogenic to extreme heat
- Non-stick properties allowing conveyance of many fluids & gases
- Outstanding resistance to ageing
- Fluoropolymer with the lowest permeability
- Non-flammable
- UV-transparent
- Tube marking on request
- Silicone-free

Three Material Grades

- Clear High Purity PFA: to cover all applications, including those requiring maximum mechanical resistance
- Coloured PFA: for circuit identification
- Black Antistatic PFA: eliminates all risk of electrostatic discharge



Food Process
Fuel Cells
Electrical/Electronics
Aircraft
Oil/Gas Industry
Pharmaceutical
Medical
Chemical
Clean Rooms

Applications

Technical Characteristics

Compatible Fluids	Medical, bio-compatible, food process, gas, compressed air
Working Pressure	Vacuum to 36 bar
Working Temperature	-196°C to +260°C
Component Materials	Perfluoroalkoxy - 55 Shore D <ul style="list-style-type: none"> High Purity PFA Translucent coloured PFA Antistatic PFA

Reliable performance is dependent upon the type of fluid conveyed and fittings being used. Use is guaranteed with a vacuum of 755 mm Hg (99% vacuum).

Regulations

Medical

USP: Class VI (A)
External communication devices

Industrial

UL94 V-0 (Fire resistance)
DI: 2002/95/EC (RoHS), 2011/65/EC
DI: 97/23/EC (PED)
RG: 1907/2006 (REACH)
DI: 94/09/EC (ATEX, black tubing)

Food Industry

FDA: 21 CFR 177.1550
(clear, translucent coloured)
RG: 1935/2004

Performance of PFA Tubing

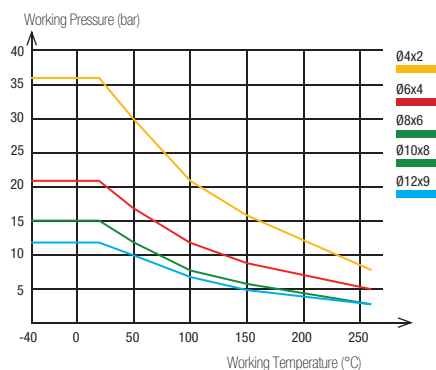

To calculate burst pressure, the values in this graph should be multiplied by 3.

Tube O.D.	Tube O.D. Tolerance
4 to 8 mm	+0.10 / -0.10
10 to 12 mm	+0.15 / -0.15





Connected to Parker Legris push-in fittings, the calibration of Parker Legris tubing ensures perfect sealing based on NF E49-100.

Packaging

Tube pack: 10 m, 50 m, 100 m





1010T..P Fluoropolymer (FEP) Tubing

Tubepack® 10 m

Ø ext. (mm)	Ø int. (mm)		 High purity	 Crystal	 Crystal	 Crystal	kg
4	2	12	1010T04P00	1010T04P12	1010T04P13	1010T04P14	0.087
6	4	34	1010T06P00	1010T06P12	1010T06P13	1010T06P14	0.237
8	6	60	1010T08P00	1010T08P12	1010T08P13	1010T08P14	0.410
10	8	95	1010T10P00				0.723
12	9	120	1010T12P00				1.148



1050T..P Fluoropolymer (FEP) Tubing

Tubepack® 50 m

Ø ext. (mm)	Ø int. (mm)		 High purity	 Crystal	 Crystal	 Crystal	kg
4	2	12	1050T04P00	1050T04P12	1050T04P13	1050T04P14	0.435
6	4	34	1050T06P00	1050T06P12	1050T06P13	1050T06P14	1.185
8	6	60	1050T08P00	1050T08P12	1050T08P13	1050T08P14	2.050
10	8	95	1050T10P00				3.615
12	9	120	1050T12P00				5.740



1100T..P Fluoropolymer (FEP) Tubing

Tubepack® 100 m

Ø ext. (mm)	Ø int. (mm)		 clear	kg
4	2	12	1100T04P00	0.870
6	4	34	1100T06P00	2.370
8	6	60	1100T08P00	4.100
10	8	95	1100T10P00	7.230
12	9	120	1100T12P00	11.480



1010T..A Fluoropolymer (FEP) Antistatic Tubing

Tubepack® 10 m

Ø ext. (mm)	Ø int. (mm)			kg
4	2	12	1010T04A01	0.087
6	4	34	1010T06A01	0.237
8	6	60	1010T08A01	0.410

1050T..A Fluoropolymer (FEP) Antistatic Tubing

Tubepack® 50 m

Ø ext. (mm)	Ø int. (mm)			kg
4	2	12	1050T04A01	0.435
6	4	34	1050T06A01	1.185
8	6	60	1050T08A01	2.050

Multi-Tubing

Our range of multi-tubing combines high quality performance and **space optimisation** in complex pneumatic circuits **covering a wide range of environments**. **Many possible configurations** are available, depending on the pressure, temperature, flexibility and compatibility requirements.

Product Advantages

Sheathed PA Tubing

- PVC sheath resistant to external damage:
 - abrasion
 - weld spatter
 - aggressive fluids
- Helically wound: minimum bend radius, compact installation
- Simplified routing
- Easy identification of circuits
- Same technical performance as PA
- Possible number of tubes: from 2 to 12, with numbering
- Silicone-free

Twin PU Ester Tubing

- Tubes fully joined for improved solidity
- External diameter maintained after separation
- Rapid identification of circuits
- Quick and easy installation
- Simplified routing
- 3 colour combinations available
- Silicone-free



Applications

Pneumatics
Automation
Robotics
Transportation
In-Plant Automotive
Process Industry

Technical Characteristics

Tube	PA	PU
Compatible Fluids	Compressed air, chemicals, industrial fluids	Compressed air, industrial fluids
Working Pressure	Vacuum to 24 bar	0 to 14 bar
Working Temperature	-40°C to +80°C	-20°C to +70°C
Component Materials	Polyamide	Polyurethane ester

Reliable performance is dependent upon the type of fluid conveyed and fittings being used. Use is guaranteed with a vacuum of 755 mm Hg (99% vacuum).

Regulations

Industrial
 DI: 2002/95/EC (RoHS), 2011/65/EC
 DI: 97/23/EC (PED)
 RG: 1907/2006 (REACH)
 Performance and chemical resistance according to DIN 73378

Packaging

Sheathed PA Tubing: Tubepack® 10 m, 50 m
Twin PU Ester Tubing: Tubepack® 25 m

Tubing Performance

Sheathed PA Tubing

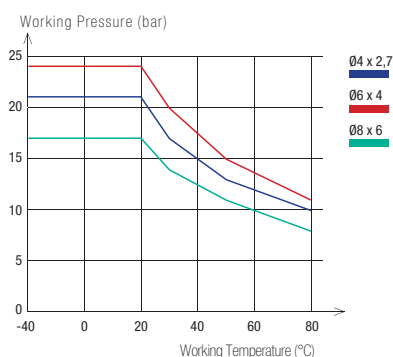

Twin PU Ester Tubing

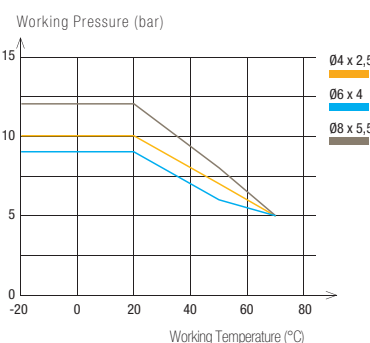



Material	Tube O.D.	Tube O.D. Tolerance
PA	4 mm	+0.05 / -0.08
	6 to 8 mm	+0.05 / -0.10
PU	4 to 8 mm	+0.10 / -0.10

Connected to Parker Legris push-in fittings, the calibration of Parker Legris tubing ensures perfect sealing based on NF E49-100 (for semi-rigid PA) and NF E49-101 (for twin PU ester).

To calculate burst pressure, the values in these graphs should be multiplied by 3.



1010P..M Semi-Rigid Polyamide (PA) Multi-Tubing

Reel 10 m

Ø ext. (mm)	Ø int. (mm)		Number of tubes		kg
4	2.7	35	4	1010P04 00M04	1.440
		45	7	1010P04 00M07	1.920
6	4	55	4	1010P06 00M04	2.300
		60	7	1010P06 00M07	2.900
8	6	45	2	1010P08 00M02	2.600





1050P..M Semi-Rigid Polyamide (PA) Multi-Tubing

Reel 50 m

Ø ext. (mm)	Ø int. (mm)		Number of tubes		kg
4	2.7	20	2	1050P04 00M02	4.400
		35	4	1050P04 00M04	6.600
		45	7	1050P04 00M07	8.200
		55	12	1050P04 00M12	15.200
6	4	45	2	1050P06 00M02	8.400
		55	4	1050P06 00M04	11.500
		60	7	1050P06 00M07	12.500
8	6	45	2	1050P08 00M02	13.000

1420U Twin Polyurethane (PU) Tubing

Tubepack® 25 m

Ø ext. (mm)	Ø int. (mm)					kg
4	2.5	12	1420U04 41	1420U04 44	1420U04 11	0.620
6	4	15	1420U06 41	1420U06 44	1420U06 11	1.182
8	5.5	20	1420U08 41	1420U08 44	1420U08 11	1.942

Colour Selection



Multi-Tubing
Semi-Rigid PA/PVC Sheath

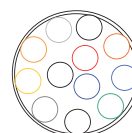

Related Products

To complement the Multi-Tubing range, Parker Legris proposes multi-connectors, shown in Chapter 1.

Push-In Fittings

Multi-Connector P. 1-31



Technical Tubing
and Hose

Calibrated Multi-Tubing

PA Recoil Tubing

Parker Legris recoil tubing has a **lasting memory after multiple uses**, offering an **alternative to reels** for excellent ergonomics and space saving. The pre-assembled tubes are equipped with a protection spring, preventing damage to the ends.

Product Advantages

Excellent Mechanical Properties

- Low pressure drop
- Good chemical compatibility
- Self-retracting
- Identical technical performance to PA tubing
- Silicone-free

Comprehensive Range

- Ready-to-use
- Various colours for circuit identification
- Available with pre-assembled connectors



Applications

- MRO
- Pneumatic Tools
- Transportation
- Lubrication
- Industrial Cleaning
- Robotics
- Car Washing

Technical Characteristics

Compatible Fluids	Compressed air, lubricants, Other fluids: please consult us
Working Pressure	Vacuum to 20 bar
Working Temperature	-20°C to +80°C
Component Materials	Polyamide (60 Shore D)

Regulations

DI: 97/23/EC (PED)
 RG: 1907/2006 (REACH)
 DI: 2002/95/EC (RoHS), 2011/65/EC

Reliable performance is dependent upon the type of fluid conveyed and fittings being used. Use is guaranteed with a vacuum of 755 mm Hg (99% vacuum).

Performance of PA Recoil Tubing

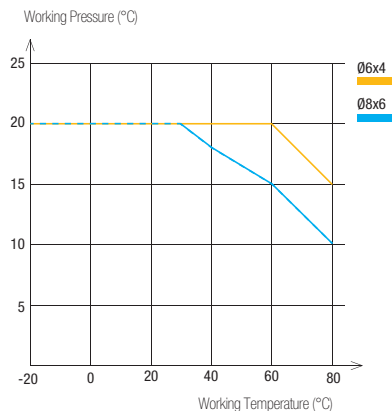

Tube O.D.	Passage	Tube O.D. Tolerance
6 mm	4 mm	+0.05 / -0.10
8 mm	6 mm	+0.05 / -0.10

Packaging

Plastic bags: 2m to 6 m
 Other lengths and colours on request

To calculate burst pressure, the values in these graphs should be multiplied by 3.

1470P

Polyamide (PA) Recoil Tubing 2 m, Male BSPT Fitting

Ø ext. (mm)	Ø int. (mm)	BSPT Thread			Total Closed Length (mm)	O.D. of Coil (mm)	kg
6	4	R1/4	1470P06 04 13	1470P06 07 13	520	60	0.143
8	6	R1/4	1470P08 04 13	1470P08 07 13	560	70	0.174

Length of long straight section: 300 mm

Length of short straight section: 100 mm

1471P

Polyamide (PA) Recoil Tubing 4 m, Male BSPT Fitting

Ø ext. (mm)	Ø int. (mm)	BSPT Thread			Total Closed Length (mm)	O.D. of Coil (mm)	kg
6	4	R1/4	1471P06 04 13	1471P06 07 13	640	60	0.199
8	6	R1/4	1471P08 04 13	1471P08 07 13	720	70	0.249

Length of long straight section: 300 mm

Length of short straight section: 100 mm

1472P

Polyamide (PA) Recoil Tubing 6 m, Male BSPT Fitting

Ø ext. (mm)	Ø int. (mm)	BSPT Thread			Total Closed Length (mm)	O.D. of Coil (mm)	kg
6	4	R1/4	1472P06 04 13	1472P06 07 13	760	60	0.260
8	6	R1/4	1472P08 04 13	1472P08 07 13	880	70	0.329

Length of long straight section: 300 mm

Length of short straight section: 100 mm

Dimensions for Recoil Tubing

Service length: maximum recommended operating length in order to ensure that the coil will continue to contract after multiple uses.

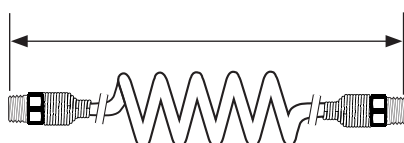

Service Length (mm)

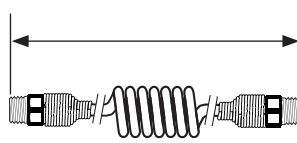

Total Closed Length (mm)

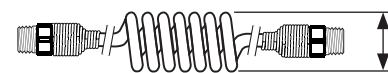

O.D. of Coil (mm)

PU Recoil Tubing

With its small coil diameter and good impact resistance, this polyurethane recoil tubing is perfect for installations requiring **flexibility** in confined spaces. Good resistance to shock and abrasion, together with a design integrating straight ends, allow for **easy and safe operation** of pneumatic equipment.

Product Advantages

Excellent Mechanical Properties

- Excellent coil memory
- Abrasion-resistant
- Perfect for rapid cycling applications
- Consistent tensile strength
- Optimum longevity
- Low pressure drop
- Lightweight with plastic protection spring
- Silicone-free

Comprehensive Range

- Available in 2 materials: PU ester and PU ether
- With or without pre-assembled fittings
- Pre-assembled plastic or metal protection springs to prevent damage to equipment and tubing



Applications

- Workshops
- Tooling
- Pneumatics
- Motion Technologies
- Robotics
- Industrial Machinery

Technical Characteristics

Compatible Fluids	Compressed air
Working Pressure	0 to 10 bar
Working Temperature	-20°C to +70°C (assembled tubing)
Component Materials	Polyurethane ester: 52 Shore D Polyurethane ether: 46 Shore D

Regulations

Industrial
 NF E49-101
 DI: 2002/95/EC (RoHS), 2011/65/EC
 DI: 97/23/EC (PED)
 RG: 1907/2006 (REACH)

Packaging

Plastic bags: from 2 m to 7.5 m

Reliable performance is dependent upon the type of fluid conveyed and fittings being used.

Performance of PU Recoil Tubing

PU Ester Recoil Tubing

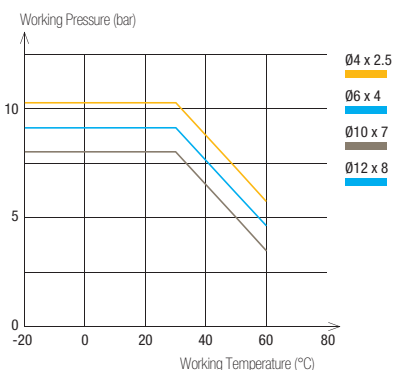

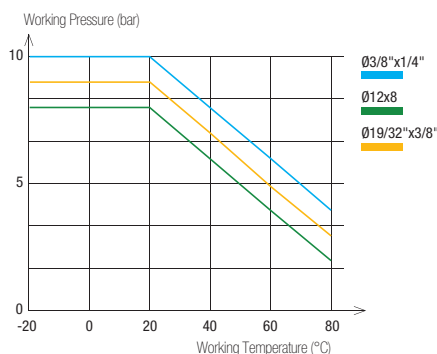

PU Ether Recoil Tubing



Tube O.D.	Tube I.D.	Tube O.D. Tolerance
4 to 8 mm	2.5 to 5.5 mm	+0.10 / -0.10
10 to 12 mm	7 to 8 mm	+0.15 / -0.15
3/8" and 19/32"	1/4" and 3/8"	+/- 0.005"



To calculate burst pressure, the values in these graphs should be multiplied by 3.

1470U Polyurethane (PU) Ester Recoil Tubing 2 m, Male BSPT Fitting

Ø ext. (mm)	Ø int. (mm)	BSPT Thread				Total Closed Length (mm)	O.D. of Coil (mm)	kg
4	2.5	R1/8	1470U04 03 10	1470U04 04 10	1470U04 05 10	595	24	0.060
6	4	R1/4	1470U06 03 13	1470U06 04 13	1470U06 05 13	630	32	0.060
8	5	R1/4	1470U08 03 13	1470U08 04 13	1470U08 05 13	780	42	0.120
10	7	R1/4	1470U10 03 13	1470U10 04 13	1470U10 05 13	780	62	0.160
12	8	R3/8	1470U12 03 17	1470U12 04 17	1470U12 05 17	780	65	0.190



Length of long straight section, O.D. < 8 mm: 300 mm; Length of long straight section, O.D. ≥ 8 mm: 500 mm; Length of short straight section, for all O.D.: 100 mm

1471U Polyurethane (PU) Ester Recoil Tubing 4 m, Male BSPT Fitting

Ø ext. (mm)	Ø int. (mm)	BSPT Thread				Total Closed Length (mm)	O.D. of Coil (mm)	kg
4	2.5	R1/8	1471U04 03 10	1471U04 04 10	1471U04 05 10	785	24	0.100
6	4	R1/4	1471U06 03 13	1471U06 04 13	1471U06 05 13	850	32	0.160
8	5	R1/4	1471U08 03 13	1471U08 04 13	1471U08 05 13	1000	42	0.200
10	7	R1/4	1471U10 03 13	1471U10 04 13	1471U10 05 13	1000	62	0.230
12	8	R3/8	1471U12 03 17	1471U12 04 17	1471U12 05 17	1140	65	0.260

Length of long straight section, O.D. < 8 mm: 300 mm; Length of long straight section, O.D. ≥ 8 mm: 500 mm; Length of short straight section, for all O.D.: 100 mm

1472U Polyurethane (PU) Ester Recoil Tubing 6 m, Male BSPT Fitting

Ø ext. (mm)	Ø int. (mm)	BSPT Thread				Total Closed Length (mm)	O.D. of Coil (mm)	kg
8	5	R1/4	1472U08 03 13	1472U08 04 13	1472U08 05 13	1230	42	0.280
10	7	R1/4	1472U10 03 13	1472U10 04 13	1472U10 05 13	1140	62	0.295
12	8	R3/8	1472U12 03 17	1472U12 04 17	1472U12 05 17	1190	65	0.310

Length of long straight section, O.D. < 8 mm: 300 mm; Length of long straight section, O.D. ≥ 8 mm: 500 mm; Length of short straight section, for all O.D.: 100 mm

1460U Polyurethane (PU) Ester Recoil Tubing 2 m

Ø ext. (mm)	Ø int. (mm)		Total Closed Length (mm)	O.D. of Coil (mm)	kg
8	5	1460U08 04	720	42	0.064
10	7	1460U10 04	720	62	0.122
12	8	1460U12 04	720	65	0.172

Length of long straight section, O.D. < 8 mm: 300 mm; Length of long straight section, O.D. ≥ 8 mm: 500 mm; Length of short straight section, for all O.D.: 100 mm

1461U Polyurethane (PU) Ester Recoil Tubing 4 m

Ø ext. (mm)	Ø int. (mm)		Total Closed Length (mm)	O.D. of Coil (mm)	kg
8	5	1461U08 04	940	42	0.128
10	7	1461U10 04	940	62	0.244
12	8	1461U12 04	940	65	0.344

Length of long straight section, O.D. < 8 mm: 300 mm; Length of long straight section, O.D. ≥ 8 mm: 500 mm; Length of short straight section, for all O.D.: 100 mm

1462U Polyurethane (PU) Ester Recoil Tubing 6 m

Ø ext. (mm)	Ø int. (mm)		Total Closed Length (mm)	O.D. of Coil (mm)	kg
8	5	1462U08 04	1260	42	0.192
10	7	1462U10 04	1260	62	1.246
12	8	1462U12 04	1260	65	0.280

Length of long straight section, O.D. < 8 mm: 300 mm; Length of long straight section, O.D. ≥ 8 mm: 500 mm; Length of short straight section, for all O.D.: 100 mm

PU Recoil Tubing

1445U..R Recoil Polyurethane (PU) Ether Tubing 3 m, Male BSPP Fitting

Ø ext. (mm)	Ø int. (mm)	BSPP Thread		Total Closed Length (mm)	O.D. of Coil (mm)	kg
8	5	G1/4	1445U08R04 13	819	40	0.170
3/8"	1/4"	G1/4	1445U60R04 13	769	60	0.230
12	8	G3/8	1445U12R04 17	789	80	0.310
19/32"	3/8"	G3/8	1445U14R04 17	759	110	0.460

1441U..R Recoil Polyurethane (PU) Ether Tubing 4 m, Male BSPP Fitting

Ø ext. (mm)	Ø int. (mm)	BSPP Thread		Total Closed Length (mm)	O.D. of Coil (mm)	kg
8	5	G1/4	1441U08R04 13	889	40	0.220
3/8"	1/4"	G1/4	1441U60R04 13	819	60	0.260
12	8	G3/8	1441U12R04 17	849	80	0.400
19/32"	3/8"	G3/8	1441U14R04 17	809	110	0.554

1442U..R Recoil Polyurethane (PU) Ether Tubing 6 m, Male BSPP Fitting

Ø ext. (mm)	Ø int. (mm)	BSPP Thread		Total Closed Length (mm)	O.D. of Coil (mm)	kg
8	5	G1/4	1442U08R04 13	1029	40	0.340
3/8"	1/4"	G1/4	1442U60R04 13	929	60	0.360
12	8	G3/8	1442U12R04 17	969	80	0.530
19/32"	3/8"	G3/8	1442U14R04 17	909	110	0.920

1447U..R Recoil Polyurethane (PU) Ether Tubing 7.5 m, Male BSPP Fitting

Ø ext. (mm)	Ø int. (mm)	BSPP Thread		Total Closed Length (mm)	O.D. of Coil (mm)	kg
8	5	G1/4	1447U08R04 13	1134	40	0.420
3/8"	1/4"	G1/4	1447U60R04 13	1009	60	0.460
12	8	G3/8	1447U12R04 17	1059	80	0.600
19/32"	3/8"	G3/8	1447U14R04 17	984	110	1.150

Accessories

0694 Push-In Fitting with Protection Spring, Male BSPP Thread

Nickel-plated brass, NBR

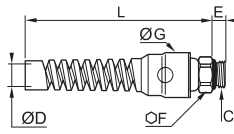

ØD	C		E	F	G	L	kg
8	G1/4	0694 08 13	6.5	16	24	104.5	0.067
10	G1/4	0694 10 13	6.5	18	24	106.5	0.062
12	G3/8	0694 12 17	7.5	20	29.5	126	0.080

0695 Push-In Fitting with Protection Spring, Male BSPT Thread

Nickel-plated brass, NBR

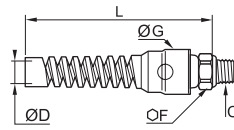

ØD	C		F	G	L	kg
8	R1/4	0695 08 13	14	24	104.5	0.055
10	R1/4	0695 10 13	18	24	106.5	0.064
12	R3/8	0695 12 17	20	29.5	126	0.090

Braided PU Recoil Hose

This recoil hose offers all the advantages of polyurethane, combining the **durability** and **kink resistance** of bulkier braided hoses with great **elasticity** and maximum **flexibility**.

Product Advantages

Excellent Mechanical Properties

Unsurpassed resistance to abrasion: 10 times better than rubber, polyamide and non-braided polyurethane
 Excellent flexibility and coil memory: minimizes work fatigue
 Highly kink and crush-resistant
 Silicone-free

Ready-to-Use

Pre-assembled threaded fittings
 Tube ends protected with a plastic spring
 Lightweight for easy handling
 3 lengths available
 Translucent blue: visibility of the fluid



Machine Tools
 Industrial Assembly
 Pneumatics
 In-Plant Automotive Workshops

Applications

Technical Characteristics

Compatible Fluids	Compressed air Other fluids: please consult us
Working Pressure	0 to 15 bar
Working Temperature	-40°C to +75°C
Component Materials	Polyurethane (85 shore A)

Regulations

DI: 97/23/EC (PED)
 RG: 1907/2006 (REACH)
 DI: 2002/95/EC (RoHS), 2011/65/EC

Reliable performance is dependent upon the type of fluid conveyed and fittings being used.

Performance of Braided PU Recoil Hose

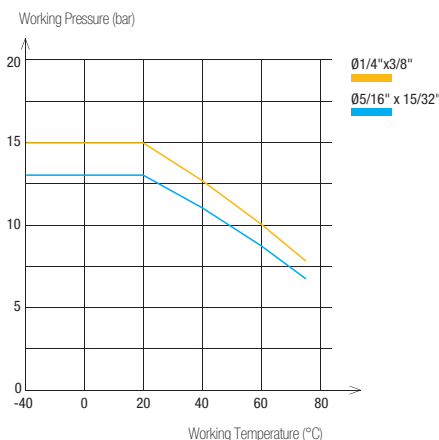

Hose O.D.	Hose I.D.	Hose I.D. Tolerance
3/8" 15/32"	1/4" 5/16"	+/- 0.005"

Packaging

Plastic bags: 3 m to 7.5 m

Connected to Parker Legris push-in fittings, the calibration of PU tubing ensures perfect sealing.

To calculate burst pressure, the values in this graph should be multiplied by 4.

1445U..E Recoil Braided Polyurethane (PU) tubing 3 m, Male BSPP Fitting

Ø ext. (mm)	Ø int. (mm)	BSPP Thread		Total Closed Length (mm)	O.D. of Coil (mm)	kg
3/8"	1/4"	G1/4	1445U60E04 13	870	42	0.210
12	8	G3/8	1445U12E04 17	880	55	0.300

1442U..E Recoil Braided Polyurethane (PU) tubing 6 m, Male BSPP Fitting

Ø ext. (mm)	Ø int. (mm)	BSPP Thread		Total Closed Length (mm)	O.D. of Coil (mm)	kg
3/8"	1/4"	G1/4	1442U60E04 13	1140	42	0.420
12	8	G3/8	1442U12E04 17	1160	55	0.600

1447U..E Recoil Braided Polyurethane (PU) tubing 7.5 m, Male BSPP Fitting

Ø ext. (mm)	Ø int. (mm)	BSPP Thread		Total Closed Length (mm)	O.D. of Coil (mm)	kg
3/8"	1/4"	G1/4	1447U60E04 13	1275	42	0.525
12	8	G3/8	1447U12E04 17	1300	55	0.750

Related Products

Parker Legris recoil tubing is designed for use with Parker Legris blowguns and couplers.

Industrial Blowguns

Polymer P. 7-3

Metal P. 7-12



Couplers

C 9000 P. 8-7

Metal P. 8-18



PVC Braided Hose

Parker Legris offers two **grades of PVC** which cover a wide range of industrial applications for the **transportation of various fluids**.

Product Advantages

Food-Grade PVC

Monograde tubing reinforced with a braided polyester ply
 Flexible: space saving during installation
 Translucent for visual identification:

- of the fluid
- of inner cleanliness
- of fluid flow

Food-grade, without phthalates
 Silicone-free

Industrial PVC

Tubing with a braided polyester ply between 2 grades of PVC
 Resistant to abrasion, impact and crushing
 Increased durability
 Lightweight and easy-to-use
 Silicone-free



Applications

- Robotics
- In-Plant Automotive
- Pneumatics
- Semi-Conductors
- Textile
- Packaging
- Vacuum

Technical Characteristics

Hose	Food-Grade PVC	Industrial PVC
Compatible Fluids	Compressed air, other fluids	Compressed air
Working Pressure	0 to 15 bar	0 to 15 bar
Working Temperature	-20°C to +70°C	-25°C to +60°C
Component Materials	Translucent food-grade PVC, phthalate-free with polyester braid	Industrial blue PVC, multi-layer, with polyester braid

Regulations

Food-Grade PVC

FDA: 21 CFR 177.1550
 RG: 1907/2006 (REACH)
 RG: 1935/2004
 DI: 2002/95/EC (RoHS), 2011/65/EC
 DI: 2007/10/EC (phthalates)

Industrial PVC

DI: 97/23/CE (PED)
 RG: 1907/2006 (REACH)
 DI: 2002/95/EC (RoHS), 2011/65/EC

Reliable performance is dependent upon the type of fluid conveyed and fittings being used.

Hose Performance

Food-Grade PVC

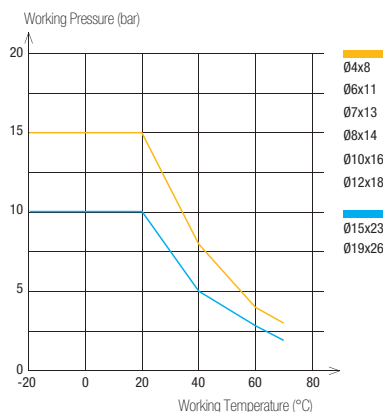

Hose Type	Hose I.D.	Hose I.D. Tolerance
Food-Grade PVC	4 to 6 mm	+0.5 / -0.5
	7 to 12 mm	+0.6 / -0.6
	15 to 19 mm	+0.8 / -0.8
Industrial PVC	6.3 mm	+0.3 / -0.3
	9 mm	+0.5 / -0.5
	12.7 mm	+0.6 / -0.6

Packaging



Reel: 25 m, 50 m
 (with protective plastic bag)

To calculate burst pressure, the values in these graphs should be multiplied by 3.
 The performances of the industrial PVC grade are available upon request.

1025V

Food-Grade Braided PVC Hose



Reel 25 m

Ø ext. (mm)	Ø int. (mm)		 clear	kg
8	4	10	1025V08 00 04	1.260
11	6	12	1025V11 00 06	2.253
13	7	14	1025V13 00 07	3.182
14	8	16	1025V14 00 08	3.434
16	10	25	1025V16 00 10	3.800
18	12	30	1025V18 00 12	4.423
23	15	40	1025V23 00 15	7.300
26	19	60	1025V26 00 19	7.300

1050V

Food-Grade Braided PVC Hose



Reel 50 m

Ø ext. (mm)	Ø int. (mm)		 clear	kg
8	4	10	1050V08 00 04	2.690
11	6	12	1050V11 00 06	4.200
13	7	14	1050V13 00 07	5.966
14	8	16	1050V14 00 08	6.058
16	10	25	1050V16 00 10	6.400
18	12	30	1050V18 00 12	8.250
23	15	40	1050V23 00 15	14.600
26	19	60	1050V26 00 19	14.600

1025V..C

Industrial-Grade Braided PVC Hose



Reel 25 m

Ø ext. (mm)	Ø int. (mm)			kg
11	6.3	45	1025V11C04 06	2.175
14	9	63	1025V14C04 09	3.250
19	12.7	89	1025V19C04 13	4.975

1050V..C

Industrial-Grade Braided PVC Hose

Reel 50 m

Ø ext. (mm)	Ø int. (mm)			kg
11	6.3	45	1050V11C04 06	4.350
14	9	63	1050V14C04 09	6.500
19	12.7	89	1050V19C04 13	9.950

Related Products

PVC tubing is designed for use with Parker Legris barb connectors and couplers.

Couplers
C 9000 P. 8-7

Metal P. 8-18

Barb Connectors
0191 P. 9-16

0123 P. 9-10

Self-Fastening NBR Hose

Parker Legris self-fastening hose is designed according to **CNOMO E07.21.115N***. This range of hose should be used with Legris barb connectors and provides both the **reliability** of self-fastening technology and **simplicity of installation**.

Product Advantages

Exceptional Endurance | Unsurpassed resistance to repetitive flexing
Protection against spark and flame
Abrasion and crush-resistant
UV-resistant

Ideal for In-Plant Automotive | Excellent ozone resistance
Perfect for cooling systems
Maximum flow with no pressure drop
4 colours for immediate circuit identification
Silicone-free

Ready-To-Use | No lubrication, additive (grease, oil, ...etc), or preparation time required
To connect: push the hose fully home against the fitting shoulder
To disassemble: cut the hose on the barbed side of the fitting



In-Plant Automotive
Cooling
Welding Robots
Pneumatics
Industrial Machinery

Applications

Technical Characteristics

Compatible Fluids	Coolants, compressed air
Working Pressure	0 to 16 bar
Working Temperature	-20°C to +100°C
Component Materials	Nitrile butadiene rubber & textile braid

Reliable performance is dependent upon the type of fluid conveyed and fittings being used.

Regulations

NFT 46-019-1
NFT 47 252
RG: 1907/2006 (REACH)
DI: 2002/95/EC (RoHS), 2011/65/EC
CNOMO: E07.21.115N

*CAUTION: CNOMO certification is valid exclusively for red and green hose, only when connected to Legris' CNOMO-certified barb connectors 0132, 0133 and 0134.

Performance of Self-Fastening NBR Hose

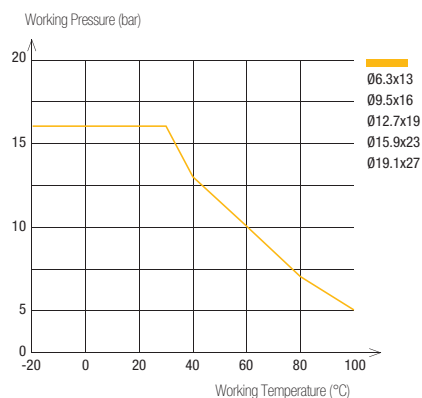

To calculate burst pressure, the values in this graph should be multiplied by 3.

DN mm CNOMO	DN (standard)	Hose I.D. (mm)	Hose I.D. Tolerance (mm)
6	1/4"	6.3 mm	+0.4 / -0.4
8	3/8"	9.5 mm	+0.5 / -0.5
12 16 20	1/2" 5/8" 3/4"	12.7 mm 15.9 mm 19.1 mm	+0.6 / -0.6

Use with water: maximum temperature 100°C
Use with air: maximum temperature 70°C





Packaging

Drum: 40 m, 80 m, 100 m

1040H

Braided Self-Fastening NBR Hose

Drum 40 m





DN	Ø ext. (mm)	Ø int. (mm)						kg
1/4	13	6.3	60	1040H56 01	1040H56 02	1040H56 03	1040H56 04	7.000
3/8	16	9.5	70	1040H60 01	1040H60 02	1040H60 03	1040H60 04	8.600
1/2	19	12.7	120	1040H62 01	1040H62 02	1040H62 03	1040H62 04	9.450
5/8	23	15.9	140	1040H66 01	1040H66 02	1040H66 03	1040H66 04	13.000
3/4	27	19.1	170	1040H69 01	1040H69 02	1040H69 03	1040H69 04	16.500

Also available in 20 m length upon request

1080H

Braided Self-Fastening NBR Hose

Drum 80 m





DN	Ø ext. (mm)	Ø int. (mm)						kg
5/8	23	15.9	140	1080H66 01	1080H66 02	1080H66 03	1080H66 04	26.160
3/4	27	19.1	170	1080H69 01	1080H69 02	1080H69 03	1080H69 04	33.160

Also available in 20 m length upon request

1100H

Braided Self-Fastening NBR Hose

Drum 100 m

DN	Ø ext. (mm)	Ø int. (mm)						kg
1/4	13	6.3	60	1100H56 01	1100H56 02	1100H56 03	1100H56 04	14.660
3/8	16	9.5	70	1100H60 01	1100H60 02	1100H60 03	1100H60 04	20.600
1/2	19	12.7	120	1100H62 01	1100H62 02	1100H62 03	1100H62 04	23.000

Also available in 20 m length upon request

Related Products

Self-fastening hose is designed for use with Parker Legris brass barb connectors (CNOMO-certified).

Barb Connectors

0132

P. 5-25

0133 .. 39

P. 5-25

0134

P. 5-25



Installation Tool

Tool Part Number:
0650 00 00 05

This automatic installation tool reduces the effort required to connect self-fastening hose onto a barb connector.



Tube Cutting and Positioning

Cut the tube at a right angle and position the barb connector on the mounting tool.



Barb connector support

Press-Fitting the Tube

Activate the press-fit tool; connection is complete when the tube is fully home on the barb connector.

This tool has been designed for use with 5 different diameters and is easy to operate.

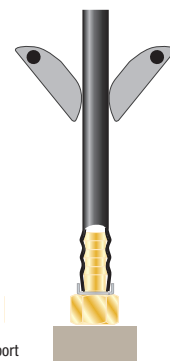

Barb connector support

Calibrated Braided Hose

Technical Tubing and Hose

Accessories

0694 Push-In Fitting with Protection Spring, Male BSPP Thread

Nickel-plated brass, NBR

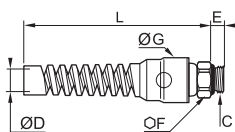

ØD	C		E	F	G	L	kg
8	G1/4	0694 08 13	6.5	16	24	104.5	0.067
10	G1/4	0694 10 13	6.5	18	24	106.5	0.062
12	G3/8	0694 12 17	7.5	20	29.5	126	0.080

0695 Push-In Fitting with Protection Spring, Male BSPT Thread

Nickel-plated brass, NBR

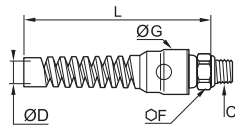

ØD	C		F	G	L	kg
8	R1/4	0695 08 13	14	24	104.5	0.055
10	R1/4	0695 10 13	18	24	106.5	0.064
12	R3/8	0695 12 17	20	29.5	126	0.090

3000 71 00 Tube Cutter

Technical polymer



	H	L	kg
3000 71 00	25	79	0.029

This tool is designed to give a clean cut at right angles to the tube axis for all resilient polymer tubing (polyamide, polyurethane, FEP, polyethylene, etc.) from 4 mm to 12 mm diameter inclusive.

Replacement blades: part number 3000 71 00 05

A spring maintains the cutter in the closed position.

3000 71 11 Tube Cutter

Treated steel

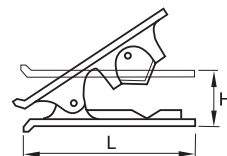

	kg
3000 71 11	0.020

Replacement blades: part number 3000 71 11 05

6000 71 00 Stripping Tool for Anti-Spark Tubing

Technical polymer, stainless steel



	kg
6000 71 00	0.098

Working principle of the stripping tool page 3-17

Accessories

1827 Stainless Steel Tube Support for Fluoropolymer Tubing

Stainless steel 316L

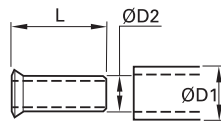

ØD1	ØD2		L	kg
6	4	1827 06 00	11.5	0.001
8	6	1827 08 00	14	0.001
10	8	1827 10 00	18	0.001
12	9	1827 12 09	18	0.001
	10	1827 12 00	18	0.001
16	14	1827 16 00	18	0.002

This tube support is necessary when using fluoropolymer tubing at all temperatures compatible with the fitting/tubing assembly.

0127 Brass Tube Support for Polymer Tubing

Brass

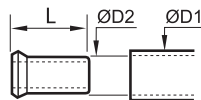

ØD1	ØD2		L	kg
4	2	0127 04 00	11	0.001
	2.7	0127 04 27	11	0.001
5	3	0127 05 03	11	0.001
	3.3	0127 05 00	11.5	0.009
6	4	0127 06 00	11.5	0.001
8	5.5	0127 08 55	14	0.001
	6	0127 08 00	14	0.001
10	7	0127 10 07	18	0.001
	7.5	0127 10 75	18	0.001
12	8	0127 10 00	18	0.002
	8	0127 12 08	18	0.002
	9	0127 12 09	18	0.002
14	10	0127 12 00	18	0.001
	11	0127 14 11	18	0.002
15	12	0127 14 00	18	0.002
16	12	0127 15 12	18	0.002
16	13	0127 16 13	18	0.003
18	14	0127 18 14	19.5	0.003
20	15	0127 20 15	20.5	0.003
22	16	0127 22 16	21	0.004
25	19	0127 25 19	25	0.007

This tube support guarantees good gripping, at high temperatures and pressures, by preventing collapsing of the tube.

CLIP Clip Strip for Tubes and Fittings

Technical polymer

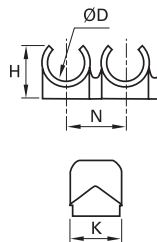

ØD		Number of Outlets	H	K	N	kg
4	CLIP 04 00	8	9	13.5	10.5	0.007
6	CLIP 06 00	8	10.5	13	10.5	0.008
8	CLIP 08 00	7	12.5	10.5	12	0.007
10	CLIP 10 00	6	14	12	15	0.005
12	CLIP 12 00	5	16.5	14	16.5	0.009
14	CLIP 14 00	4	18	16	20.5	0.009

Delivered in boxes of 10 strips of the same diameter (complete with self-tapping screws of 95 mm length) These clips can be used with metric or inch tubing.

0697 Clip for Braided Tubing

Treated steel

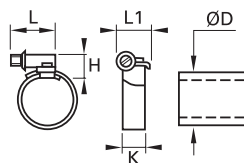

ØD		H	K	L	L1	kg
6-11	0697 00 01	7	5	12	7	0.004
10-16	0697 00 02	12	9	21	13	0.012
12-22	0697 00 03	12	9	21	13	0.014
16-27	0697 00 04	12	9	24	13	0.015
20-32	0697 00 05	12	9	24	13	0.016

Chemical Compatibility Chart

Recommended	1	Not Recommended	3
Satisfactory	2	Not Available	-

Substances	PA	PU Ether	PU Ester	Low Density PE	Advanced PE	FEP/PFA
Acetaldehyde	1	-	-	3	-	1
Acetone	1	3	1	3	-	1
Acid, chromic up to 10%	-	3	3	1 (50%)	-	1
Acid, citric	3	-	-	1	1 up to 60°C	1
Acid, formic up to 10%	-	2	3	1	1 at 25% at 20°C	1
Acid, hydrochloric up to 10%	1	1	3	1	1 at 20°C	1
Acid, phosphoric up to 50%	3	2	3	1	2 at 20°C	1
Acid, sulphuric up to 10%	3	1	3	1	1	1
Acid, acetic	2 at 10%	1	3	1 (50%)	1 (50 %)	1
Acid, nitric	3	3	3	1 (40%); 3(>40%)	-	1
Ammonia and gaseous	1	1	3	2	1	1
Ammonium chloride up to 10%	-	1	1	1	1	1
Benzene	1	3	3	3	3	1
Bromine	3	-	-	3	3	1
Butane	1	1	1	1 (20°C)	1	1
Butyl acetate	1	3	2	-	-	1
Butylic and butyl alcohol	-	-	-	1 (20°C)	1	1
Calcium choride	-	1 (10% & 40%)	2 (10% & 40%)	1	1	1
Carbon tetrachloride (sodium hypochlorite)	2	3	2	1 (30%)	3	1
Chloroform	3	3	3	3	-	1
Compressed air	1	1	1	1	1	1
Cyclohexanone	1	3	3	3	-	1
Ethanol	1	2	2	3	-	1
Ethyl acetate	1	2	2	2 (20°C)	2 (23°C); 3 (85°C)	1
Ethyl alcohol	-	-	-	3	1 (23°C); 3 (85°C)	1
Ethylene oxide	1	-	-	-	-	1
Formalin (formaldehyde)	2	-	-	1 (40%)	-	1
Freon 12-22	1	2	2	-	-	1
Glucose	1	-	-	-	1	1
Glycol (without H ₂ O)	-	1	1	-	-	1
Hydrogen	1	-	-	1	1	1
Hydrogen peroxide (perydrol)	3	2	2	1 (10%)	1	1
Kerosene	1	1	1	-	3	1
Magnesium chloride (up to 30%)	1	1	2	1	1	1
Methane	1	1	1	-	-	1
Methanol	1	2	3	-	-	1
Methyl acetate	-	2	2	-	-	1
Methyl alcohol (pure)	-	-	-	-	2	1

Chemical Compatibility Chart

Substances	PA	PU Ether	PU Ester	Low Density PE	Advanced PE	FEP/PFA
Methyl chloride	2	3	2	-	-	1
Methyl ethyl ketone	1	3	3	3	-	1
Oils (paraffin)	-	1	1	-	-	1
Oils, engine (diesel)	1	2	1	-	-	1
Oxygen	1	-	1	1 (20°C)	-	1
Ozone	3	2 or 1	1	3	3	1
Perchlorate ethylene	1	3	3	-	-	1
Petrol, with up to 40% aromatics	1	-	2	-	-	1
Petrol, with more than 40% aromatics	1	-	3	-	-	1
Phenols	3	-	3	3	-	1
Potash	-	-	3	1	-	1
Potassium chloride up to 40%	1	1	2	1	-	1
Potassium hydroxide	1 (50%)	1 (3n)	2	1	1	1
Potassium manganate 5%	-	3	2	-	-	1
Potassium sulphate	1	-	-	1	1	1
Propane	1	1	1	-	-	1
Sodium carbonate	1	-	-	1	1	1
Sodium chloride	1 (50%)	1	2	1	-	1
Sodium hydroxide (caustic soda)	1 (60%)	-	-	1	1	1
Sodium hypochlorite (bleach)	1	2	3	1 (30%)	-	1
Tetrachloroethylene	1	2	2	-	-	1
Toluene	1	2	2	3	3	1
Tributylphosphate	1	-	-	-	-	1
Trichlorethylene	1	3	3	3	-	1
Water (distilled, deionised)	-	1	1	-	-	1
Water (drinking, food)	-	-	-	-	1	1
Water (industrial)	1	-	-	-	1	1
Water (sea)	-	-	-	-	-	1
Xylem	-	2	2	-	-	1
Zinc chloride	1 (10%)	-	-	1	-	1

For other fluids, concentrations or special implementation, please contact us.

Function Fittings

Flow Control Regulators

Piloted Function Fittings

Non-Return Valves

LIQUIfit®

Pressure Fittings

Other Function Fittings

Silencers



Function Fittings

Flow Control Regulators

[P. 4-6]



Function: controls the speed of the cylinder rod
Materials: polymer, metal, stainless steel
Pressure: 10 bar
Temperature: 0°C to +70°C
 -25°C to +70°C (metal version)
Ø metric: 3 mm to 18 mm
Threads: BSPP, BSPT, metric

Blocking Fittings

[P. 4-36]



Function: provides safety by locking the cylinder piston
Materials: nickel-plated brass, polymer
Pressure: 10 bar
Temperature: -20°C to +70°C
Ø metric: 6 mm to 12 mm
Threads: BSPP, BSPT

Piloted Non-Return Valves

[P. 4-38]



Function: provides safety by locking the cylinder piston
Materials: nickel-plated brass, polymer
Pressure: 10 bar
Temperature: -5°C to +60°C
Ø metric: 6 mm to 12 mm
Threads: BSPP

Non-Return Valves

[P. 4-40]



Function: allows air to pass in one direction only
Materials: polymer, nickel-plated brass
Pressure: 10 bar
Temperature: 0°C to +70°C
Ø metric: 4 mm to 12 mm
Threads: BSPP, BSPT, metric

Adjustable Non-Return Valves

[P. 4-42]



Function: allows air to pass in one direction with an adjustable opening pressure
Materials: FDA chemical nickel-plated brass
Pressure: 12 bar
Temperature: -20°C to +80°C
Threads: BSPP, metric

LIQUIFIT® Non-Return Valves

[P. 4-44]



Function: allows fluid to pass in one direction only
Materials: polymer for food applications
Pressure: 10 bar
Temperature: 0°C to +65°C
Ø inch: 1/4" to 1/2"

Stainless Steel Non-Return Valves

[P. 4-46]



Function: allows fluid to pass in one direction only
Materials: stainless steel
Pressure: 0.5 to 40 bar
Temperature: -20°C to +180°C
DN : 10 mm to 25 mm
Threads: BSPP, NPT

Soft Start Fittings

[P. 4-48]



Function: protects the installation at start-up
Materials: polymer, nickel-plated brass
Pressure: 3 to 10 bar
Temperature: -15°C to +60°C
Ø metric : 8 mm to 12 mm
Threads: BSPP

Pneumatic Sensor Fittings

[P. 4-50]



Function: pneumatic or electric output signal, detects end of cylinder rod stroke
Materials: polymer, treated metal
Pressure: 3 to 8 bar
Temperature: -15°C to +60°C
Ø metric: 4 mm
Threads: BSPP, metric

Function Fittings

Pressure Regulators (P. 4-52)



Function: stabilise the maximum pressure delivered to pneumatic equipment

Materials: polymer, treated metal

Pressure: 16 bar (upstream), 8 bar (downstream)

Temperature: -10°C to +70°C

Ø metric: 4 mm to 10 mm

Threads: BSPP

Pressure Reducers (P. 4-54)



Function: set the maximum pressure delivered to pneumatic equipment

Materials: polymer, treated metal

Pressure: 8 bar

Temperature: -15°C to +60°C

Ø metric: 6 mm to 10 mm

Threads: BSPP

Snap Connectors (P. 4-56)



Function: isolates a circuit without venting the whole system

Materials: polymer, nickel-plated brass

Pressure: 10 bar

Temperature: -20°C to +80°C

Ø DN: 5 mm to 7 mm

Threads: BSPP

Manually-Operated Valves (P. 4-58)



Function: opens/closes a circuit, with or without venting

Materials: polymer, nickel-plated brass, aluminium

Pressure: 10 bar, 16 bar (0669)

Temperature: -10°C to +80°C, -5°C to +70°C (0669)

Ø metric: 4 mm to 10 mm

Threads: BSPP, metric

Metal Quick Exhaust Valves (P. 4-60)



Function: increases the return speed of the cylinder

Materials: nickel-plated brass, aluminium, stainless steel

Pressure: 10 bar

Temperature: -20°C to +70°C

Threads: BSPP, BSPT, metric

Silencers (P. 4-62)



Function: reduces noise levels

Materials: sintered bronze, polyethylene, stainless steel, nickel-plated brass

Pressure: 12 bar

Temperature: -20°C to +180°C







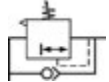

Ø metric: 4 mm to 12 mm

Threads: BSPP, metric, NPT

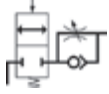
Selecting your Function Fitting

Protect Your System	Blocking Fittings	Maintain the load following an emergency stop of a pneumatic system.	Models 7880 - 7881 - 7883 - 7885 7886
	Soft Start Fittings	Increase the pressure gradually in order to protect it from potentially damaging shock when a pneumatic system is restarted.	Models 7860 - 7861 - 7870 - 7871
	Non-Return Valves	Allow compressed air or fluids to flow in one direction, and prevent it from flowing in the other. If the supply is accidentally shut off, the air can only escape in one direction.	Models 4890 - 4891 - 4892 - 4895 7930 - 7931 - 7932 - 7984 7985 - 7992 - 7994 - 7995 7996
	Piloted Non-Return Valves	Incorporate 3 functions into one product to protect your system: piloted non-return valve, flow control regulator and manual vent.	Models 7892 - 7894
Detect End of Cylinder Rod Stroke	Pneumatic Sensor Fittings	Detect the back pressure drop at the end of stroke to produce a signal (pneumatic or electronic) to allow reciprocation.	Models 7818 - 7828
Control and Improve the Performance of Your System	Pressure Regulators	Regulate and stabilise the pressure at a maximum determined value whatever the upstream pressure.	Models 7300
	Pressure Reducer Fittings	Reduce the pressure consumed in one section of the machine in order to save energy.	Models 7316 - 7318 - 7416 - 7471
	Quick Exhaust Valves	Increase the return speed of the cylinder by discharging the exhaust directly to atmosphere.	Models 7899 - 7970 - 7971
	Silencers	Reduce the noise levels whilst air is vented from a compressed air system.	Models 0670 - 0671 - 0672 - 0673 0674 - 0675 - 0676 - 0677
Working on Your System	Snap Fittings	Allow a circuit to be isolated without fully venting the system.	Models 7921 - 7926 - 7960 - 7961
	Manually-Operated Valves	Allow for repeated venting by simply moving the valve sleeve or the manually-operated valve lever.	Models 0669 - 7800 - 7801 - 7802

Symbols for Function Fittings

<p>Regulating air flow</p> 	<p>Regulating pressure by stabilising at a required value</p> 
<p>Blocking air circulation</p> 	<p>Reducing pressure supply</p> 
<p>Blocking and regulating air flow</p> 	<p>Progressive pressurising of circuits</p> 
<p>Controlling allows the passage of fluid in one direction and prevents it in the other</p> 	<p>Isolating a circuit without venting the entire system</p> 
<p>Exhausting system and controlling pneumatic circuit supply</p> 	<p>Regulating, blocking and venting to protect the system and individuals</p> 
<p>Detecting pressure drop</p> 	

Selecting Your Flow Control Regulator

The comprehensive range of Parker Legris flow control regulators provides a solution for all flow regulation functions in a pneumatic system.

Select the model suited to your application according to:

5 Key Requirements

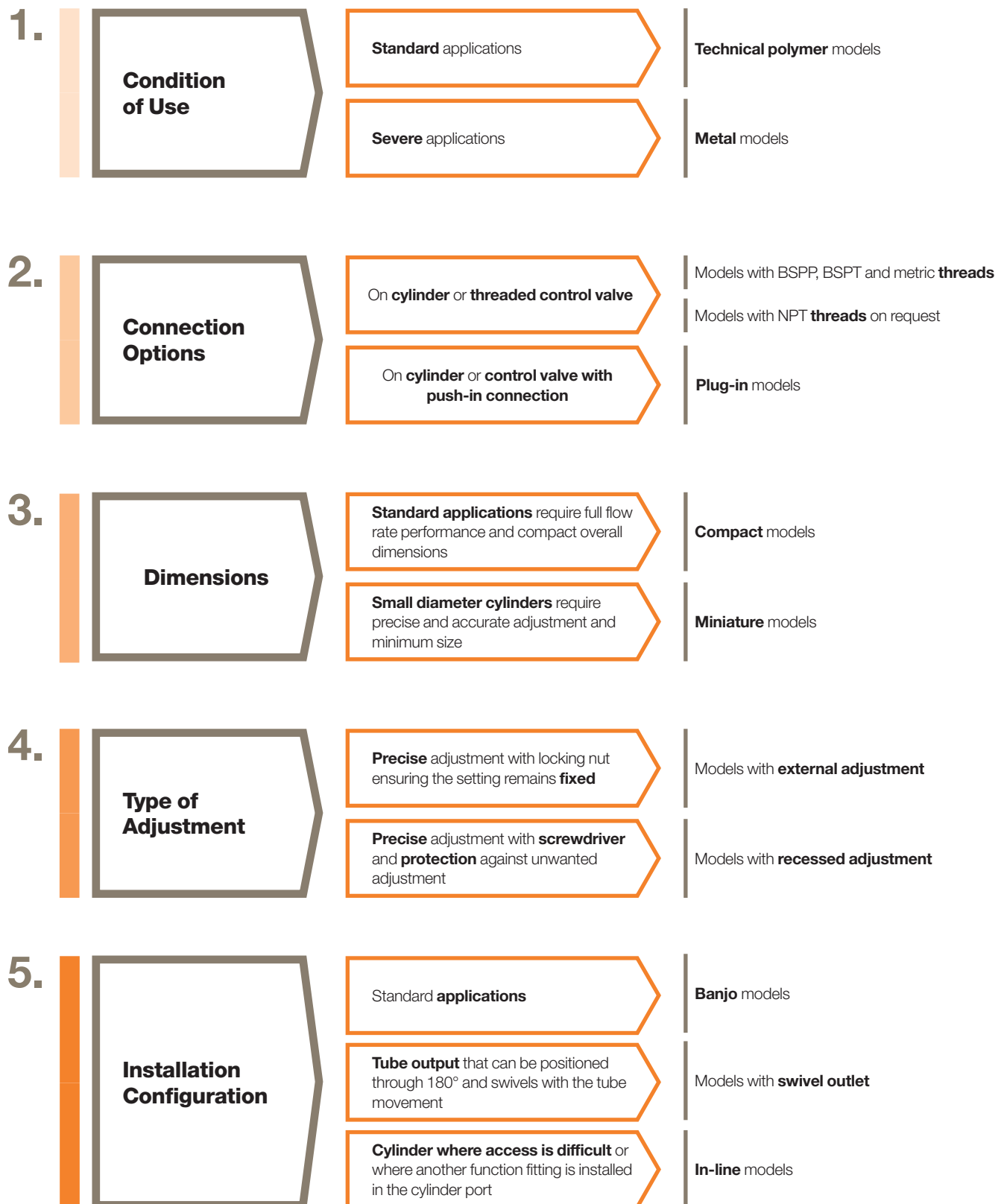

Flow Control Regulator Range

Technical Polymer Version, BSPP and Metric

Recessed Adjustment

7010
7011
7012
Push-In
Page 4-10



External Adjustment

7060
7061
7062
Compact
Push-In
Page 4-11/12



7660
7662
7669
Miniature
Push-In
Page 4-13/14



Swivel Outlet

7040
7041
Compact
Push-In
Page 4-14



7640
7649
Miniature
Push-In
Page 4-15



In-Line

7770
7772
Push-In
Page 4-16



7776
Bulkhead
Push-In
Page 4-16



7771
Threaded
Page 4-16



7020
Straight
Push-In
Page 4-17



7000
Page 4-16



Plug-In

7030
7031
Compact
Push-In
Page 4-18



7630
7631
Miniature
Push-In
Page 4-18



Technical Polymer Version, BSPT

External Adjustment

7065
7066
7067
Compact
Push-In
Page 4-11/12



7665
7668
Miniature
Push-In
Page 4-13



Swivel Outlet and External Adjustment

7045
Compact
Push-In
Page 4-14



7645
Miniature
Push-In
Page 4-15



Brass, Nickel-Plated Brass and Aluminium Versions, BSPP and Metric

Recessed Adjustment

7130
Push-In
Page 4-19



7140
Threaded
Page 4-19



7160
Compression
Page 4-19



In-Line

7170
Bulkhead
Threaded
Page 4-21



External Adjustment

7762
Compression
Page 4-21



7100
7101
Compact
Push-In
Page 4-20



7680
Compact
Push-In
Page 4-20



7180
Miniature
Push-In
Page 4-20



7110
7111
Compact
Threaded
Page 4-20/21



7190
Miniature
Threaded
Page 4-21



Stainless Steel Versions

7810
7812
Threaded
Page 4-23



7820
7822
Threaded
Page 4-23



Flow Control Regulators

Parker Legris flow control regulators with polymer, nickel-plated brass or aluminium bodies, external or recessed adjustment screws, offer **precise adjustment, accuracy** and **compactness** providing the solution for all applications.

Product Advantages

Improved Productivity

- Higher maximum flow than standard regulators
- Full flow with minimum pressure drop (model 7060)
- Optimal control of the cylinder rod speed
- 100% leak-tested in production
- Date coding to guarantee quality and traceability
- Reduce compressed air and energy consumption

Accuracy & Performance

- Precise adjustment for accurate flow regulation from initial to maximum opening
- Constant cylinder rod displacement speed
- Long-term stability of flow
- Reduced weight (polymer version)
- Mechanical strength and corrosion resistance with nickel-plated brass version

Ergonomics & Large Range

- External adjustment screw: easy to adjust without tooling and lockable
- Recessed adjustment screw: more compact and protects the adjustment mechanism
- Uni-directional: exhaust or inlet
- Bi-directional: adjustment of air flow in both directions
- 360° positioning
- NPT version on request



Pneumatics
Robotics
Semi-Conductors
Railway
Textile
Automotive Process
Packaging

Applications

Technical Characteristics

Compatible Fluids	Compressed air Other fluids: contact us
Working Pressure	1 to 10 bar
Working Temperature	0°C to +70°C -25°C to +70°C (metal version)

Max. Tightening Torques (external adjustment screw)	Threads	M3 x0.5	M5 x0.8	G1/8	G1/4	G3/8	G1/2
	daN.m	0.06	0.16	0.8	1.2	3	3.5
Max. Tightening Torques (recessed adjustment screw)	Threads	-	M5 x0.8	G1/8	G1/4	G3/8	G1/2
	daN.m	-	0.1	0.4	0.5	0.6	0.7

Reliable performance is dependent upon the type of fluid conveyed and component materials being used.
Use is guaranteed with a vacuum of 755 mm Hg (99% vacuum).
You will find all the flow rate characteristic curves (to 6 bar) for flow control regulators at the end of the chapter.

Component Materials

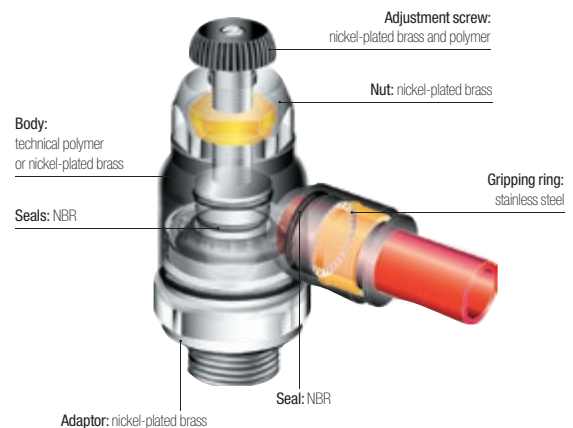

Silicone-free

Regulations

EN 45545 - Railway applications - Fire protection on railway (metal version)
 DI: 2002/95/EC (RoHS)
 RG: 1907/2006 (REACH)
 DI: 97/23/EC (PED)

Flow Control Regulators

Operation

Parker Legris offers both uni-directional and bi-directional flow control regulators.

The uni-directional models control the flow of air in one direction through an adjustable restrictor, while allowing full flow in the opposite direction.

The bi-directional models control the flow of air in both directions.

A more precise and constant flow regulation is obtained when the regulator is fitted directly onto the cylinder.

Models with Recessed Adjustment

Uni-Directional (Exhaust Version)

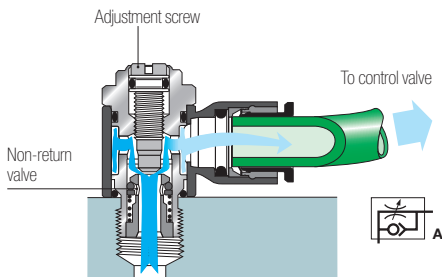

Uni-Directional (Supply Version)

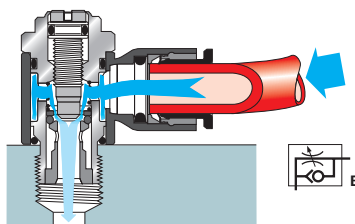

Bi-Directional Version

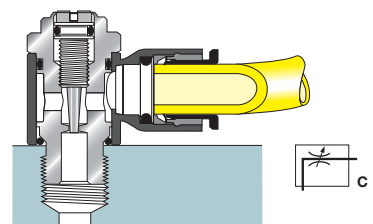

Models with External Adjustment

Uni-Directional (Exhaust Version)

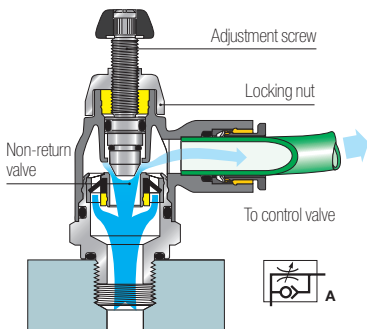

Uni-Directional (Supply Version)

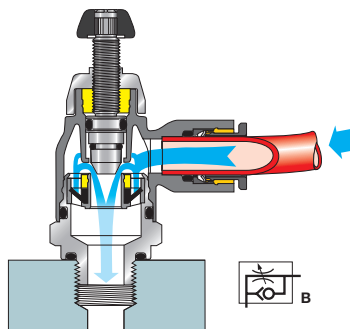

Bi-Directional Version

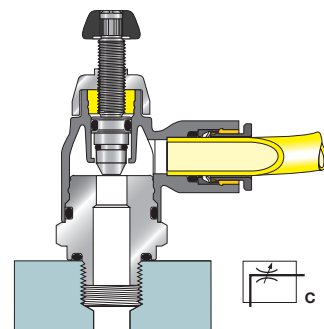

In-Line Models

Uni-Directional Version

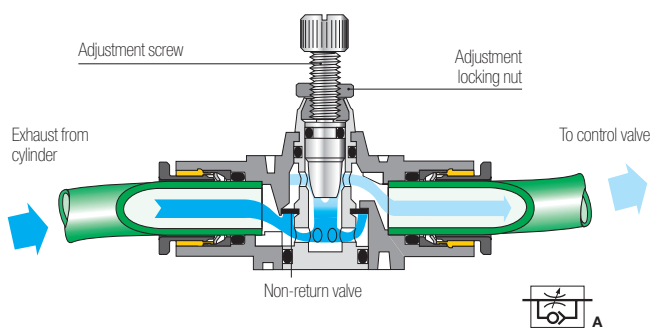

Bi-Directional Version

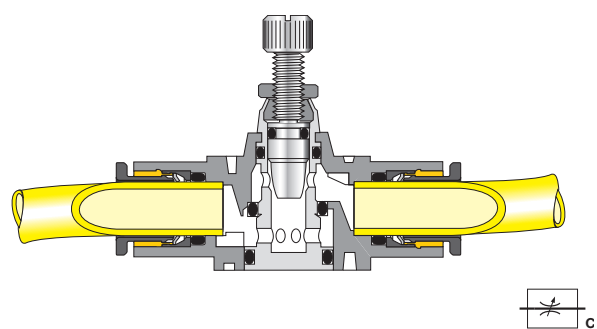

For instant visual identification, each Parker Legris flow control regulator version is identified by the related pneumatic symbol and by a letter:

- uni-directional regulation on exhaust: letter A
- uni-directional regulation on supply: letter B
- bi-directional regulation: letter C

Regulators with Recessed Adjustment

7010 Flow Regulator with Recessed Adjustment Screw Exhaust, Male BSPP and Metric Thread

Technical polymer, nickel-plated brass, NBR

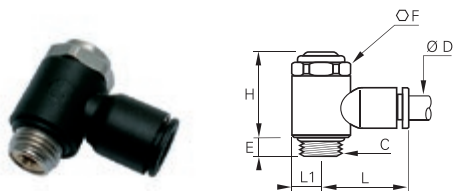

ØD	C		E	F	H	L	L1	Kg
4	M5x0.8	7010 04 19	4	8	17.5	17	5	0.006
	G1/8	7010 04 10	5	13	25	19	7	0.017
6	M5x0.8	7010 06 19	4	8	17.5	19	5	0.006
	G1/8	7010 06 10	5	13	25	21	7	0.018
8	G1/4	7010 06 13	8	17	26.5	22	9.5	0.034
	G1/8	7010 08 10	5	13	25	26	7	0.019
10	G1/4	7010 08 13	8	17	26.5	27	9.5	0.035
	G3/8	7010 08 17	7.5	20	37.5	29	11	0.068
12	G1/4	7010 10 13	8	17	26.5	29	9.5	0.035
	G3/8	7010 10 17	7.5	20	37.5	31	11	0.067
12	G1/2	7010 10 21	8	23	43	37	13.5	0.117
	G3/8	7010 12 17	7.5	20	37.5	34.5	11	0.069
	G1/2	7010 12 21	8	23	43	37	13.5	0.108

7011 Flow Regulator with Recessed Adjustment Screw Supply, Male BSPP and Metric Thread

Technical polymer, nickel-plated brass, NBR

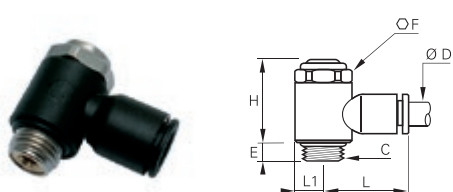

ØD	C		E	F	H	L	L1	Kg
4	M5x0.8	7011 04 19	4	8	17.5	17	5	0.006
	G1/8	7011 04 10	5	13	25	19	7	0.017
6	M5x0.8	7011 06 19	4	8	17.5	19	5	0.006
	G1/8	7011 06 10	5	13	25	21	7	0.018
8	G1/4	7011 06 13	8	17	26.5	22	9.5	0.034
	G1/8	7011 08 10	5	13	25	26	7	0.019
10	G1/4	7011 08 13	8	17	26.5	27	9.5	0.034
	G3/8	7011 08 17	7.5	20	37.5	29	11	0.067
10	G1/4	7011 10 13	8	17	26.5	29	9.5	0.036
	G3/8	7011 10 17	7.5	20	37.5	31	11	0.068

7012 Bi-Directional Flow Regulator with Recessed Adjustment Screw Male BSPP and Metric Thread

Technical polymer, nickel-plated brass, NBR

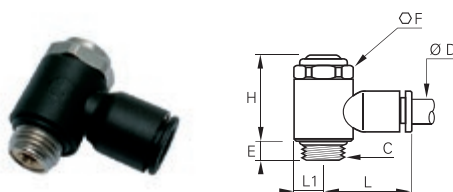

ØD	C		E	F	H	L	L1	Kg
4	M5x0.8	7012 04 19	4	8	17.5	17	5	0.006
	G1/8	7012 04 10	5	13	25	19	7	0.018
6	M5x0.8	7012 06 19	4	8	17.5	19	5	0.006
	G1/8	7012 06 10	5	13	25	21	7	0.019
8	G1/4	7012 06 13	8	17	26.5	22	9.5	0.035
	G1/8	7012 08 10	5	13	25	26	7	0.019
12	G1/4	7012 08 13	8	17	26.5	27	9.5	0.036
	G3/8	7012 08 17	7.5	20	37.5	29	11	0.071

Each pneumatic function fitting is identified by:

- the item type
- the tube outside diameter
- the thread or 2nd tube outside diameter

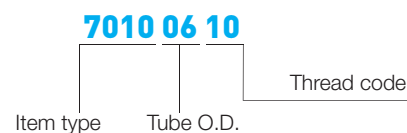

Compact Regulators with External Adjustment

7060 Compact Flow Regulator Exhaust, Male BSPP Thread



Technical polymer, nickel-plated brass, NBR

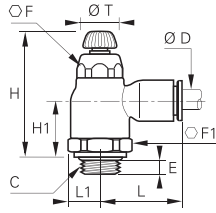

ØD	C		E	F	F1	H	H _{max}	H1	L	L1	ØT	Kg
4	G1/8	7060 04 10	5	10	16	38	44	16	22	9	10	0.020
	G1/8	7060 06 10	5	10	16	38	44	16	22	9	10	0.020
6	G1/4	7060 06 13	5.5	10	16	36.5	42.5	15	22	9	10	0.020
	G1/8	7060 08 10	4.5	14	19	41.5	48	18	28	10.5	14	0.032
8	G1/4	7060 08 13	5.5	14	19	41.5	48	18.5	28	10.5	14	0.034
	G3/8	7060 08 17	5.5	14	19	41.5	48	17	28	11	14	0.034
10	G1/4	7060 10 13	5.5	17	23	45.5	53.5	20	31.5	12.5	17	0.053
	G3/8	7060 10 17	5.5	17	23	45.5	54	20	31.5	12.5	17	0.054
12	G3/8	7060 12 17	5.5	17	23	45.5	54	20	35	12.5	17	0.056
	G1/2	7060 12 21	7.5	17	24	45.5	54	20	35	13	17	0.058

7065 Compact Flow Regulator Exhaust, Male BSPT Thread



Technical polymer, nickel-plated brass, NBR

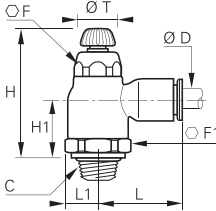

ØD	C		F	F1	H _{min}	H _{max}	H1	L	L1	ØT	Kg
6	R1/8	7065 06 10	10	16	36.5	42.5	15	22	8	10	0.021
	R1/8	7065 08 10	14	19	40	45	16.5	28	10.5	14	0.034
8	R1/4	7065 08 13	14	19	40	45	16.5	28	10.5	14	0.036
	R1/4	7065 10 13	17	23	43.5	51.5	18	31.5	12.5	17	0.053
10	R3/8	7065 10 17	17	23	43.5	51.5	18	31.5	12.5	17	0.055
	R1/2	7065 10 21	17	23	43.5	51.5	18	31.5	12.5	17	0.059
12	R1/4	7065 12 13	17	23	43.5	51.5	18	35	12.5	17	0.056
	R3/8	7065 12 17	17	23	43.5	51.5	18	35	12.5	17	0.059
	R1/2	7065 12 21	17	23	43.5	51.5	18	35	12.5	17	0.064

Pre-coated thread

7061 Compact Flow Regulator Supply, Male BSPP Thread



Technical polymer, nickel-plated brass, NBR

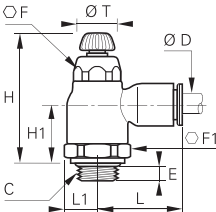

ØD	C		E	F	F1	H	H _{max}	H1	L	L1	ØT	Kg
4	G1/8	7061 04 10	5	10	16	38	44	16	22	9	10	0.020
	G1/8	7061 06 10	5	10	16	38	44	16	22	9	10	0.020
6	G1/4	7061 06 13	5.5	10	16	36.5	42.5	15	22	9	10	0.021
	G1/8	7061 08 10	4.5	14	19	41.5	48	18	28	10.5	14	0.033
8	G1/4	7061 08 13	5.5	14	19	41.5	48	18.5	28	10.5	14	0.034
	G3/8	7061 08 17	5.5	14	23	41.5	48	17	28	11	14	0.033
10	G1/4	7061 10 13	5.5	17	23	45.5	53.5	20	31.5	12.5	17	0.053
	G3/8	7061 10 17	5.5	17	23	45.5	54	20	31.5	12.5	17	0.054
12	G1/2	7061 12 21	7.5	17	24	45.5	54	20	35	13	17	0.060

7066 Compact Flow Regulator Supply, Male BSPT Thread



Technical polymer, nickel-plated brass, NBR

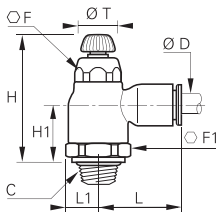

ØD	C		F	F1	H _{min}	H _{max}	H1	L	L1	ØT	Kg
10	R1/4	7066 10 13	17	23	43.5	51.5	18	31.5	12.5	17	0.020
	R3/8	7066 10 17	17	23	43.5	51.5	18	31.5	12.5	17	0.020
12	R1/2	7066 10 21	17	23	43.5	51.5	18	31.5	12.5	17	0.059
	R1/4	7066 12 13	17	23	43.5	51.5	18	35	12.5	17	0.056
12	R3/8	7066 12 17	17	23	43.5	51.5	18	35	12.5	17	0.059
	R1/2	7066 12 21	17	23	43.5	51.5	18	35	12.5	17	0.064

Pre-coated thread

Compact Regulators with External Adjustment

7062 Bi-Directional Compact Flow Regulator, Male BSPP Thread



Technical polymer, nickel-plated brass, NBR

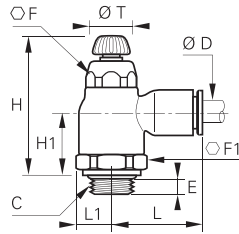

ØD	C		E	F	F1	H	H _{max}	H1	L	L1	ØT	Kg
4	G1/8	7062 04 10	5	10	16	38	44	16	22	9	10	0.025
	G1/8	7062 06 10	5	10	16	38	44	16	22	9	10	0.025
6	G1/4	7062 06 13	5.5	10	16	36.5	42.5	15	22	9	10	0.025
	G1/8	7062 08 10	4.5	14	19	41.5	48	18	28	10.5	14	0.043
8	G1/4	7062 08 13	5.5	14	19	41.5	48	18.5	28	10.5	14	0.046
	G3/8	7062 08 17	5.5	14	19	41.5	48	17	28	11	14	0.042

7067 Bi-Directional Compact Flow Regulator, Male BSPT Thread



Technical polymer, nickel-plated brass, NBR

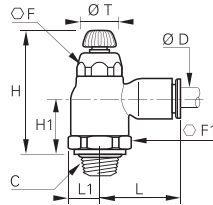

ØD	C		F	F1	H _{min}	H _{max}	H1	L	L1	ØT	Kg
4	R1/8	7067 04 10	10	16	36.5	42.5	14.7	22	9	10	0.025
	R1/8	7067 06 10	10	16	36.5	42.5	14.7	22	9	10	0.010
6	R1/4	7067 06 13	10	16	36.5	42.5	14.7	22	9	10	0.014
	R1/8	7067 08 10	14	19	40	45	16.5	28	10.5	14	0.034
8	R1/4	7067 08 13	14	19	40	45	16.5	28	10.5	14	0.036
	R3/8	7067 08 17	14	19	40	45	16.5	28	11	14	0.042

Pre-coated thread

Miniature Regulators with External Adjustment

7660

Miniature Flow Regulator Exhaust, Male BSPP and Metric Thread



Technical polymer, nickel-plated brass, NBR

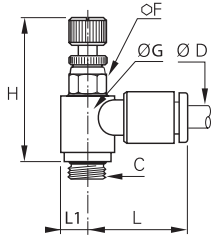

ØD	C		F	G	H _{min}	H _{max}	L	L1	Kg
3	M3x0.5	7660 03 09	6	9	23.5	26	17	4.5	0.007
	M5x0.8	7660 03 19	6	9	23.5	26	17	4.5	0.006
4	M3x0.5	7660 04 09	6	9	23.5	26	16.5	4.5	0.007
	M5x0.8	7660 04 19	6	9	23.5	26	17	4.5	0.006
6	G1/8	7660 04 10	7	11.5	27	29.5	18	6	0.012
	M5x0.8	7660 06 19	6	9	23.5	26	18	4.5	0.006
8	G1/8	7660 06 10	7	11.5	27	29.5	18.5	6	0.012
	G1/4	7660 06 13	8	12	30	32.5	19	6	0.019
8	G1/8	7660 08 10	13	14	26.5	31	26	7	0.021
	G1/4	7660 08 13	16	19	29	34	27.5	9.5	0.033
	G3/8	7660 08 17	20	23	36	42	29	11.5	0.061

7665

Miniature Flow Regulator Exhaust, Male BSPT Thread



Technical polymer, nickel-plated brass, NBR

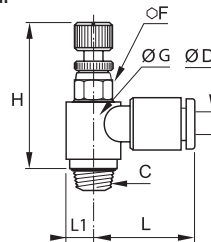

ØD	C		F	G	H _{min}	H _{max}	L	L1	Kg
4	R1/8	7665 04 10	7	11.5	25	27.5	18	6	0.012
	R1/8	7665 06 10	7	11.5	25	27.5	18.5	6	0.012
6	R1/4	7665 06 13	8	13.5	27.5	30	19	7	0.019
	R3/8	7665 06 17	17	13.5	31.5	34	19	7	0.025
8	R1/8	7665 08 10	13	14	24	28.5	26	7	0.021
	R1/4	7665 08 13	16	19	25	29	27.5	9.5	0.033
	R3/8	7665 08 17	20	23	30	36	29	11.5	0.061

Pre-coated thread

7669

Miniature Flow Regulator Supply, Male BSPP and Metric Thread



Technical polymer, nickel-plated brass, NBR

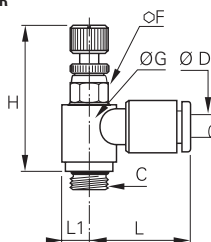

ØD	C		F	G	H _{min}	H _{max}	L	L1	Kg
3	M3x0.5	7669 03 09	6	9	23.5	26	17	4.5	0.008
	M5x0.8	7669 03 19	6	9	23.5	26	17	4.5	0.007
4	M5x0.8	7669 04 19	6	9	23.5	26	17	4.5	0.006
	G1/8	7669 04 10	7	11.5	27	29.5	18	6	0.012
6	M5x0.8	7669 06 19	6	9	23.5	26	18	4.5	0.007
	G1/8	7669 06 10	7	11.5	27	29.5	18.5	6	0.013
8	G1/4	7669 06 13	8	12	30	32.5	19	6	0.019
	G1/8	7669 08 10	13	14	26.5	31	26	7	0.021
8	G1/4	7669 08 13	16	19	29	34	27.5	9.5	0.033
	G3/8	7669 08 17	20	23	36	42	29	11.5	0.063

7668

Miniature Flow Regulator Supply, Male BSPT Thread



Technical polymer, nickel-plated brass, NBR

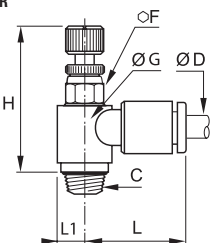

ØD	C		F	G	H _{min}	H _{max}	L	L1	Kg
4	R1/8	7668 04 10	7	11.5	25	27.5	18	6	0.011
	R1/8	7668 06 10	7	11.5	25	27.5	18.5	6	0.012
6	R1/4	7668 06 13	8	13.5	27.5	30	19	7	0.019
	R1/8	7668 08 10	13	14	24	28.5	26	7	0.020
8	R1/4	7668 08 13	16	19	25	29	27.5	9.5	0.032
	R3/8	7668 08 17	20	23	30	36	29	11.5	0.061

Pre-coated thread

Regulators with External Adjustment

7662

Bi-Directional Miniature Flow Regulator, Male BSPP and Metric Thread



Technical polymer, nickel-plated brass, NBR

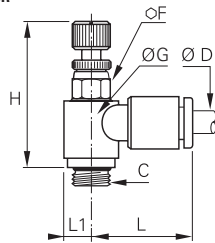

ØD	C		F	G	H _{min}	H _{max}	L	L1	Kg
4	M5x0.8	7662 04 19	6	9	23.5	26	17	4.5	0.007
	G1/8	7662 04 10	7	11.5	27	29.5	18	6	0.013
6	M5x0.8	7662 06 19	6	9	23.5	26	18	4.5	0.010
	G1/8	7662 06 10	7	11.5	27	29.5	18.5	6	0.013
	G1/4	7662 06 13	8	12	30	32.5	19	6	0.019

7040

Compact Flow Regulator Swivel Outlet Exhaust, Male BSPP Thread



Technical polymer, nickel-plated brass, NBR

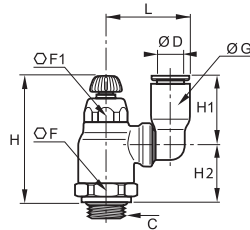

ØD	C		F	F1	G	H _{min}	H _{max}	H1	H2	L	Kg
6	G1/8	7040 06 10	16	10	10.5	38	44	16	18	23.5	0.024
	G1/4	7040 06 13	16	10	10.5	36.5	42.5	16	16.5	23.5	0.025
	G1/8	7040 08 10	19	14	13.5	41.5	48	23	19	28	0.037
8	G1/4	7040 08 13	19	14	13.5	41.5	48	23	19.5	28	0.039
	G3/8	7040 08 17	19	14	13.5	41.5	48	23	17.5	28	0.020
10	G1/4	7040 10 13	23	17	16	45.5	53.5	26.5	21	35	0.051
	G3/8	7040 10 17	23	17	16	45.5	54	26.5	21.5	35	0.063
12	G3/8	7040 12 17	23	17	19	45.5	54	30.5	21.5	38	0.066
	G1/2	7040 12 21	24	17	19	45.5	54	30.5	21	38	0.071

7045

Compact Flow Regulator Swivel Outlet Exhaust, Male BSPT Thread



Technical polymer, nickel-plated brass, NBR

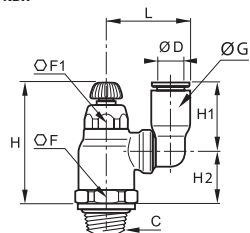

ØD	C		F	F1	G	H _{min}	H _{max}	H1	H2	L	Kg
6	R1/4	7045 06 13	16	10	10.5	36.5	42.5	16	16.5	23.5	0.030
	R1/8	7045 08 10	19	14	13.5	40	46	23	17	28	0.014
8	R1/4	7045 08 13	19	14	13.5	40	46	23	17	28	0.043
	R3/8	7045 08 17	19	14	13.5	40	46	23	17	28	0.044
10	R1/4	7045 10 13	23	17	16	43.5	51.5	26.5	19	35	0.062
	R3/8	7045 10 17	23	17	16	43.5	51.5	26.5	19	35	0.065
12	R3/8	7045 12 17	23	17	19	43.5	51.5	31	19	38	0.065
	R1/2	7045 12 21	23	17	19	43.5	51.5	31	19	38	0.070

Pre-coated thread

7041

Compact Flow Regulator Swivel Outlet Supply, Male BSPP Thread



Technical polymer, nickel-plated brass, NBR

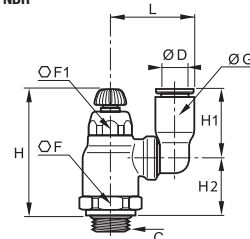

ØD	C		F	F1	G	H _{min}	H _{max}	H1	H2	L	Kg
6	G1/4	7041 06 13	16	10	10.5	36.5	42.5	16	16.5	23.5	0.024
8	G1/8	7041 08 10	19	14	13.5	41.5	48	23	19	28	0.037
	G1/4	7041 08 13	19	14	13.5	41.5	48	23	19.5	28	0.039

Miniature Regulators with Swivel Outlet and External Adjustment

7640

Miniature Swivel Outlet Flow Regulator Exhaust, Male BSPP and Metric Thread



Technical polymer, nickel-plated brass, NBR

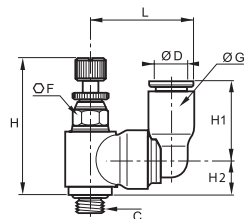

ØD	C		F	G	H _{min}	H _{max}	H1	H2	L	Kg
4	M5x0.8	7640 04 19	6	8.5	23.5	26	14	6.5	19.5	0.011
	G1/8	7640 04 10	7	8.5	27	29.5	14	8	19.5	0.015
6	M5x0.8	7640 06 19	6	10.5	23.5	26	16	6.5	21	0.001
	G1/8	7640 06 10	7	10.5	27	29.5	16	8	20.5	0.015

7645

Miniature Swivel Outlet Flow Regulator Exhaust, Male BSPT Thread



Technical polymer, nickel-plated brass, NBR

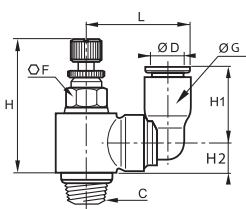

ØD	C		F	G	G1	H _{min}	H _{max}	H1	H2	J	L	Kg
4	R1/8	7645 04 10	7	11.5	8.5	25	27.5	14	6	11.5	19.5	0.014
6	R1/8	7645 06 10	7	11.5	10.5	25	27.5	16	6	11.5	21.5	0.012

Pre-coated thread

7649

Miniature Swivel Outlet Flow Regulator Supply, Male BSPP and Metric Thread



Technical polymer, nickel-plated brass, NBR

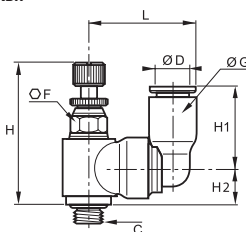

ØD	C		F	G	H _{min}	H _{max}	H1	H2	L	Kg
4	M5x0.8	7649 04 19	6	8.5	23.5	26	14	6.5	19	0.015
	G1/8	7649 04 10	7	8.5	27	29.5	14	8.5	19.5	0.014
6	M5x0.8	7649 06 19	6	10.5	23.5	26	16	6.5	21	0.008
	G1/8	7649 06 10	7	10.5	27	29.5	16	8.5	21.5	0.015

Associated Products

All our flow control regulators are compatible with the range of polyamide and polyurethane tubing shown in Chapter 3.

In-Line Regulators with External Adjustment

7770 In-Line One-Way Flow Regulator



Technical polymer, nickel-plated brass, NBR

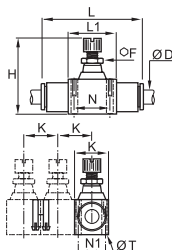

ØD		F	H _{min}	H _{max}	K	L	L1	N	N1	ØT	Kg
4	7770 04 00	5	29.5	33.5	12	36	15	11	8	2.2	0.010
6	7770 06 00	8	40.5	44.5	17	51	23	17	11	3.2	0.027
8	7770 08 00	11	46.5	52.5	18.5	58	26	20	12.5	3.2	0.048
10	7770 10 00	14	53	61	24	73	33	26	16	4.2	0.097
12	7770 12 00	14	59	67.5	28	85	35	27.5	20	4.2	0.132

7772 Bi-Directional In-Line Flow Regulator



Technical polymer, nickel-plated brass, NBR

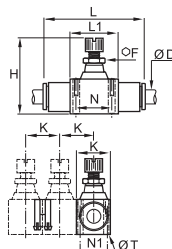

ØD		F	H _{min}	H _{max}	K	L	L1	N	N1	ØT	Kg
4	7772 04 00	5	29.5	33.5	12	36	15	11	8	2.2	0.011
6	7772 06 00	8	40	44.5	17	51	23	17	11	3.2	0.032
8	7772 08 00	11	46.5	52.5	18.5	58	26	20	12.5	3.2	0.054

7776 Panel-Mountable In-Line One-Way Flow Regulator



Technical polymer, nickel-plated brass, NBR

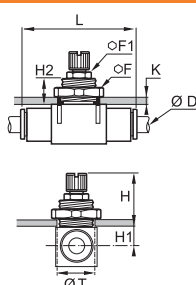

ØD		F	F1	H	H _{max}	H1	H2	K	L	ØT	Kg
4	7776 04 00*	14	-	21.5	25.5	6.5	11	6	36	10.5	0.017
6	7776 06 00*	19	-	27.5	32.5	7.5	13.5	7	51	16.5	0.042
8	7776 08 00	24	11	28.5	34.5	9	13.5	7	58	18.5	0.069
10	7776 10 00	30	14	29.5	38.5	11.5	13.5	7	73	24.5	0.136
12	7776 12 00	32	14	32	42	12.5	15.5	8	85	27.5	0.185

*Ultrafine adjustment

7771 In-Line One-Way Flow Regulator, Female BSPP Thread



Technical polymer, nickel-plated brass, NBR

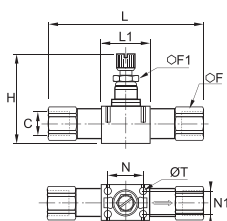

C		F	F1	H _{min}	H _{max}	L	L1	N	N1	ØT	Kg
G1/8	7771 10 10	13	8	39.5	44.5	68.5	23	17	11	3.2	0.043
G1/4	7771 13 13	16	11	44	50	83	26	20	12.5	3.2	0.103
G3/8	7771 17 17	19	14	52	61	97	33	26	16	4.2	0.160
G1/2	7771 21 21	24	14	57.5	67.5	121	35	27.5	20	4.2	0.260

7000 Joining Clips

Technical polymer

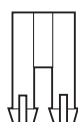

ØD		Kg
4	7000 00 05	0.005
6	7000 00 05	0.005
8	7000 00 05	0.005
10	7000 00 06	0.009
12	7000 00 06	0.009

In-Line Regulators with External Adjustment

7020 Straight Flow Regulator Exhaust, Male BSPP Thread



Technical polymer, nickel-plated brass, NBR

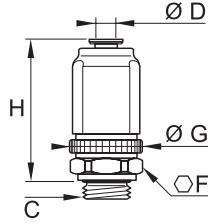

ØD	C		F	G	H min	H max	Kg
4	G1/8	7020 04 10	18	21.5	38.5	44	0.062
6	G1/8	7020 06 10	18	21.5	38.5	44	0.058
	G1/4	7020 06 13	18	21.5	38.5	44	0.060
8	G1/8	7020 08 10	24	27	46.5	52.5	0.110
	G1/4	7020 08 13	24	27	46.5	52.5	0.112

Plug-In Regulators with External Adjustment

7030 Compact Plug-In Flow Regulator, Exhaust



Technical polymer, nickel-plated brass, NBR

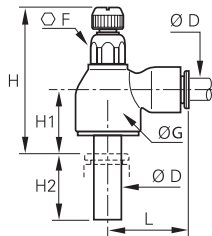

ØD		F	G	H _{min}	H _{max}	H1	H2	L	Kg
6	7030 06 00	10	16	35	41	14	17	22	0.013
8	7030 08 00	14	19	39.5	46.5	16	21.5	28	0.022
10	7030 10 00	17	23	43.5	51.5	17.5	24.5	31.5	0.030
12	7030 12 00	17	23	43	51	17	27	35	0.044

7031 Compact Plug-In Flow Regulator, Supply



Technical polymer, nickel-plated brass, NBR

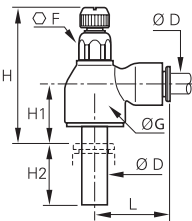

ØD		F	G	H _{min}	H _{max}	H1	H2	L	Kg
6	7031 06 00	10	16	35	41	14	17	22	0.013
8	7031 08 00	14	19	39.5	46.5	16	21.5	28	0.035
10	7031 10 00	17	23	43.5	51.5	17.5	24.5	31.5	0.010
12	7031 12 00	17	23	43	51	17	27	35	0.044

7630 Miniature Plug-In Flow Regulator, Exhaust



Technical polymer, nickel-plated brass, NBR

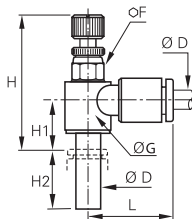

ØD		F	G	H _{min}	H _{max}	H1	H2	L	Kg
4	7630 04 00	6	9	25.5	28	9.5	15.5	17	0.007
6	7630 06 00	7	11.5	27.5	29	10.5	17	18.5	0.012

7631 Miniature Plug-In Flow Regulator, Supply



Technical polymer, nickel-plated brass, NBR

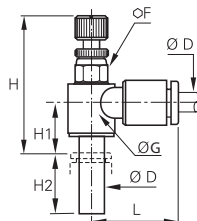

ØD		F	G	H _{min}	H _{max}	H1	H2	L	Kg
4	7631 04 00	6	9	25.5	28	9.5	15.5	17	0.007
6	7631 06 00	7	11.5	27.5	29	10.5	17	18.5	0.011

Metal Regulators with Recessed Adjustment

7130

Flow Regulator, Exhaust, Male BSPP and Metric Thread



Nickel-plated brass, NBR

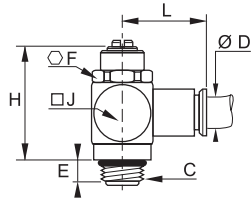

ØD	C		E	F	H	J	L	Kg
4	M5x0.8	7130 04 19	4	8	17	9	19	0.010
	G1/8	7130 04 10	5	13	34	15	20	0.036
6	M5x0.8	7130 06 19	4	8	17	9	24	0.013
	G1/8	7130 06 10	5	13	34	15	22	0.038
	G1/4	7130 06 13	8	17	39	18	24	0.062
8	G1/8	7130 08 10	5	13	34	15	25	0.042
	G1/4	7130 08 13	8	17	39	18	28	0.066
	G3/8	7130 08 17	7	20	47	21.5	29	0.109
10	G1/4	7130 10 13	8	17	39	18	30	0.075
	G3/8	7130 10 17	7	20	47	21.5	32	0.120
	G1/2	7130 10 21	8	23	61	28	34	0.227
12	G3/8	7130 12 17	7	20	47	22	36	0.064
	G1/2	7130 12 21	8	23	61	28	38	0.306

7140

Flow Regulator Exhaust, Male/Female BSPP and Metric Thread



Nickel-plated brass, NBR

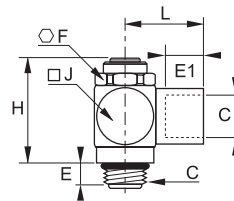

C		E	E1	F	H	J	L	Kg
M5x0.8	7140 19 19	4	4	8	21	9	11	0.009
G1/8	7140 10 10	5	8	13	32	15	17	0.039
G1/4	7140 13 13	8	12	17	39	18	24	0.073
G3/8	7140 17 17	7	12	20	47	21.5	27	0.125
G1/2	7140 21 21	8	15	23	61	28	31	0.238

7160

Flow Regulator with Brass Compression Fitting, Exhaust, Male BSPP Thread



Nickel-plated brass, NBR

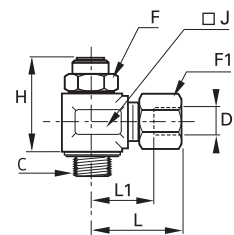

ØD	C		F	F1	H	J	L	L1	Kg
4	G1/8	7160 04 10	13	10	26	17	25.5	14.5	0.049
	G1/8	7160 06 10	13	13	26	17	25.5	14.5	0.054
6	G1/4	7160 06 13	17	13	31.5	22	28.5	17.5	0.101
	G1/8	7160 08 10	13	14	26	17	29.5	15.5	0.055
8	G1/4	7160 08 13	17	14	31.5	22	31	17	0.101
	G1/4	7160 10 13	17	19	31.5	22	35	19	0.118
10	G3/8	7160 10 17	20	19	44.5	22	37.5	19	0.189
	G1/2	7160 10 21	23	19	50	27	37.5	19	0.204
12	G3/8	7160 12 17	20	22	44.5	22	38	21.5	0.200
	G1/2	7160 12 21	23	22	50	27	38	21.5	0.213

Metal Regulators with External Adjustment

7100 Compact Flow Regulator, Exhaust, Male BSPP Thread



Nickel-plated brass, NBR

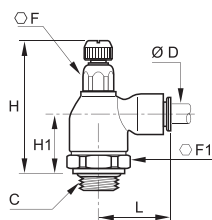

ØD	C		F	F1	H min	H max	H1	L	Kg
4	G1/8	7100 04 10	10	19	47	53	23	21	0.080
	G1/8	7100 06 10	10	19	47	53	23	24.5	0.082
6	G1/4	7100 06 13	10	19	47.5	53	23.5	24.5	0.085
	G1/8	7100 08 10	14	19	50	55	24.5	29	0.097
8	G1/4	7100 08 13	14	19	50	56	25	29	0.100
	G3/8	7100 08 17	17	25	56	62	27	30.5	0.154
10	G1/4	7100 10 13	14	19	50	56	25	35	0.106
	G3/8	7100 10 17	17	25	56	62	27	35	0.157
12	G3/8	7100 12 17	17	25	56	62	27	38	0.198
	G1/2	7100 12 21	17	25	55	62	27	38	0.207
14	G1/2	7100 14 21	17	25	55	62	27	41	0.205

7101 Compact Flow Regulator, Supply, Male BSPP Thread



Nickel-plated brass, NBR

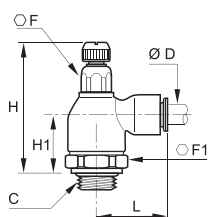

ØD	C		F	F1	H min	H max	H1	L	Kg
4	G1/8	7101 04 10	10	19	47	53	23	21	0.096
	G1/8	7101 06 10	10	19	47	53	23	24.5	0.081
6	G1/4	7101 06 13	10	19	47.5	53	23.5	24.5	0.084
	G1/8	7101 08 10	14	19	50	55	24.5	29	0.097
8	G1/4	7101 08 13	14	19	50	56	25	29	0.100
	G3/8	7101 08 17	17	25	56	62	27	30.5	0.155

7680 Compact Flow Regulator, Male BSPP Thread



Nickel-plated brass, NBR

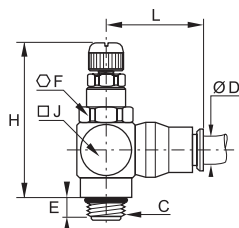

ØD	C		E	F	H min	H max	J	L	Kg
6	G1/8	7680 06 10	5	13	39	44	7.5	24.5	0.045
	G1/8	7680 08 10	5	13	39	44	7.5	24.5	0.047
8	G1/4	7680 08 13	8	17	41	47	9	27	0.076
	G3/8	7680 10 17	7	20	50	60	11	34	0.133
12	G1/2	7680 12 21	8	23	65	77	14	36.5	0.165

7180 Miniature Flow Regulator Exhaust, Male BSPP and Metric Thread



Nickel-plated brass, NBR

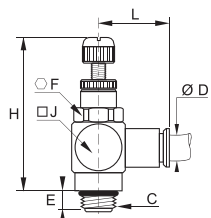

ØD	C		E	F	H min	H max	J	L	Kg
4	M5x0.8	7180 04 19	4	8	24	29	10	19	0.012
	G1/8	7180 04 10	5	13	39	44	15	20	0.041
6	M5x0.8	7180 06 19	4	8	24	29	10	24	0.015
	G1/8	7180 06 10	5	13	39	44	15	22	0.043
8	G1/8	7180 08 10	5	13	39	44	15	26	0.049

7110 Compact Flow Regulator Exhaust, Male/Female BSPP Thread



Nickel-plated brass, NBR

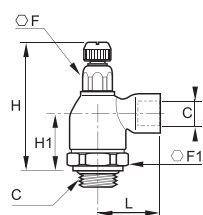

C		F	F1	H min	H max	H1	L	Kg
G1/8	7110 10 10	10	19	47	52.5	23	22.5	0.080
G1/4	7110 13 13	14	19	50.5	55.5	25	32	0.107
G3/8	7110 17 17	17	25	56	62	27	34.5	0.212
G1/2	7110 21 21	17	25	55	62	27	37.5	0.191

Metal Regulators with External Adjustment

7111 Compact Flow Regulator Supply, Male/Female BSPP Thread



Nickel-plated brass, NBR

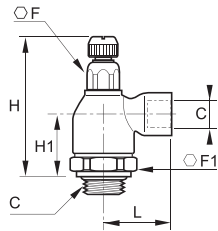

C		F	F1	H _{min}	H _{max}	H1	L	Kg
G1/8	7111 10 10	10	19	47	52.5	23	22.5	0.079
G1/4	7111 13 13	14	19	50.5	55.5	25	32	0.108

7190 Miniature Flow Regulator Exhaust, Male/Female BSPP and Metric Thread



Nickel-plated brass, NBR

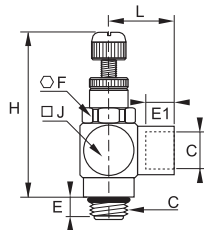

C		E	E1	F	H _{min}	H _{max}	J	L	Kg
M5x0.8	7190 19 19	4	4	8	24	29	10	11	0.012
G1/8	7190 10 10	5	8	13	39	44	15	17	0.044

7762 Flow Regulator Exhaust, with Brass Compression Fitting, Male BSPP Thread



Brass, NBR, zinc-plated steel with NBR seal, nickel-plated brass

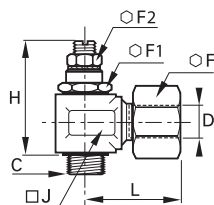

ØD	C		F	F1	F2	H _{min}	H _{max}	J	L	Kg
8	G1/8	7762 08 10*	14	14	7	35.5	38.5	17	28.5	0.056
10	G1/4	7762 10 13	19	17	10	44	49	22	36.5	0.125
14	G3/8	7762 14 17	24	22	13	58	65	27	37.5	0.220
18	G1/2	7762 18 21	30	27	19	62.5	68.5	34	44	0.403

*with adjustment knurl

7170 Panel-Mountable In-Line Flow Regulator, Female BSPP and Metric Thread



Treated aluminium, NBR, brass

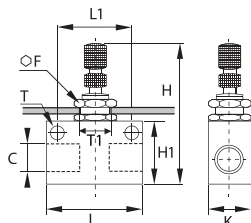

C		F	H _{min}	H _{max}	H1	K	L	L1	ØT	ØT1	Kg
M5x0.8	7170 19 19	12	38	42	15	12	25	18	4.5	10.5	0.022
G1/8	7170 10 10	15	49	56	22	18	35	24.7	4.5	12.5	0.056
G1/4	7170 13 13	15	57	64	30	20	46	35	6.5	12.5	0.085
G3/8	7170 17 17	22	62	73	30	25	50	35	6.5	18.5	0.153
G1/2	7170 21 21	22	72	83	40	25	60	44	6.5	18.5	0.196

Stainless Steel Flow Control Regulators

Stainless steel flow control regulators are used to **regulate the speed of a cylinder rod** as well as gas flow in environments with high mechanical or chemical constraints.

Product Advantages

- Robust**
 - Suitable for corrosive environments
 - Excellent mechanical and chemical resistance
 - 100% leak-tested in production
 - No contamination of conveyed fluids
- Optimised Design**
 - Smooth external surfaces to facilitate cleaning
 - Fully compatible with food environments
 - Accurate and easy adjustment



- Applications**
- Food Process
 - Robotics
 - Textile
 - Semi-Conductors
 - Packaging
 - Pneumatics
 - Automotive Process

Technical Characteristics

Compatible Fluids	Compressed air 7822: all compatible fluids depending on whether FKM or PTFE seals are used
Working Pressure	7810-7812: 1 to 10 bar 7820: 1 to 16 bar 7822: 1 to 40 bar
Working Temperature	7810 – 7812: 0°C to +70°C 7820 – 7822: -15° to +120°C

Component Materials



External Components

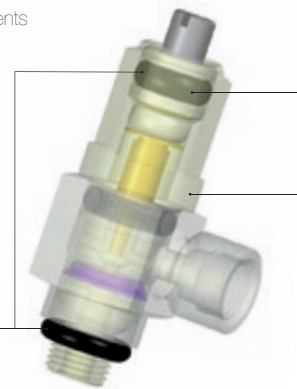

Adjustment screw:
316L stainless steel

Body:
316L stainless steel

Seals: FKM

Regulations

- DI: 2002/95/EC (RoHS)
- RG: 1907/2006 (REACH)
- DI: 97/23/EC (PED)
- RG: External Components: 21CFR (FDA)
- RG: External Components: 1935/2004/EC

Operation

Exhaust Model with External Adjustment

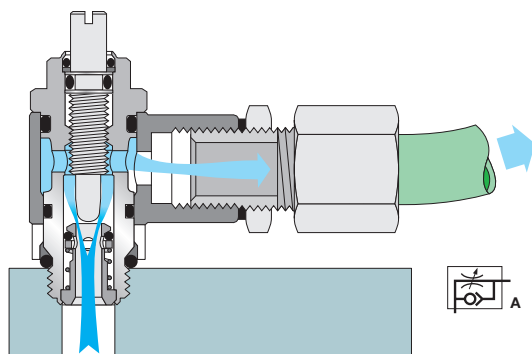

Bi-Directional Model with External Adjustment

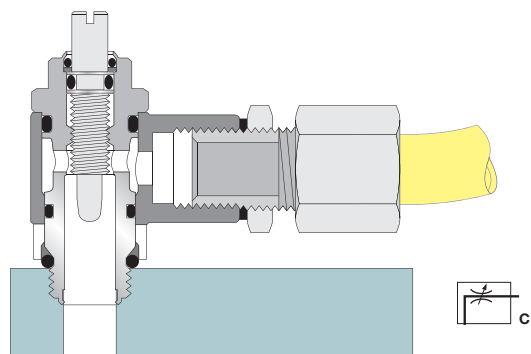

Stainless Steel Flow Control Regulators

7810 Flow Regulator Exhaust, Male/Female BSPP and Metric Thread



Stainless steel 316L, FKM

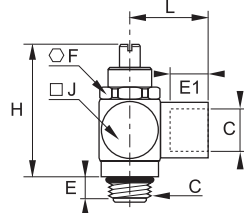

C		E	E1	F	H _{min}	H _{max}	J	L	Kg
M5x0.8	7810 19 19	4	4	8	22	26	9	11	0.011
G1/8	7810 10 10	6	8	13	32	38	15	17	0.040
G1/4	7810 13 13	9	12	17	35	40	18	24	0.072
G3/8	7810 17 17	8	12	20	43	53	22	27	0.126
G1/2	7810 21 21	9	15	23	60	71	28	31	0.261

7812 Bi-Directional Flow Regulator, Male/Female BSPP and Metric Thread



Stainless steel 316L, FKM

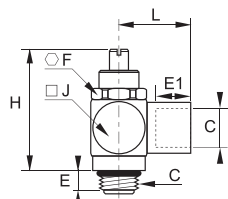

C		E	E1	F	H _{min}	H _{max}	J	L	Kg
M5x0.8	7812 19 19	4	4	8	22	26	9	11	0.011
G1/8	7812 10 10	6	8	13	32	38	15	17	0.040
G1/4	7812 13 13	9	12	17	35	40	18	24	0.074
G3/8	7812 17 17	8	12	20	43	53	22	24	0.125
G1/2	7812 21 21	9	15	23	60	71	28	31	0.261

7820 In-Line One-Way Flow Regulator, Female BSPP Thread



Stainless steel 316L, FKM

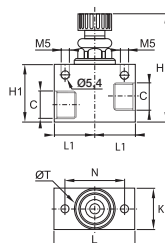

C	DN		H _{min}	H _{max}	H1	K	L	L1	N	ØT	Kg
G1/8	7	7820 00 10	47	52.5	30	20	40	20	30	20	0.175
G1/4	7	7820 00 13	47	52.5	30	20	40	20	30	20	0.164
G3/8	9	7820 00 17	56	65	35	25	50	25	36	25	0.286
G1/2	12	7820 00 21	76	87	40	30	60	30	42	30	0.262

7822 Bi-Directional In-Line Flow Regulator, Female BSPP Thread



Stainless steel 316L, FKM

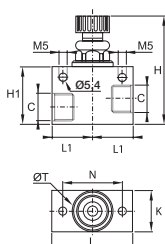

C	DN		H _{min}	H _{max}	H1	K	L	L1	N	ØT	Kg
G1/8	7	7822 00 10	48	52.5	30	20	40	20	30	20	0.176
G1/4	7	7822 00 13	48	52.5	30	20	40	20	30	20	0.165
G3/8	9	7822 00 17	58	65	35	25	50	25	36	20	0.289
G1/2	12	7822 00 21	76	87	40	30	60	30	42	30	0.265

You will also find our range of stainless steel push-in fittings, compression fittings, valves and accessories in this catalogue.

Flow Characteristics (at 6 bar)

for Flow Control Regulators



7010
7011
7012

7010

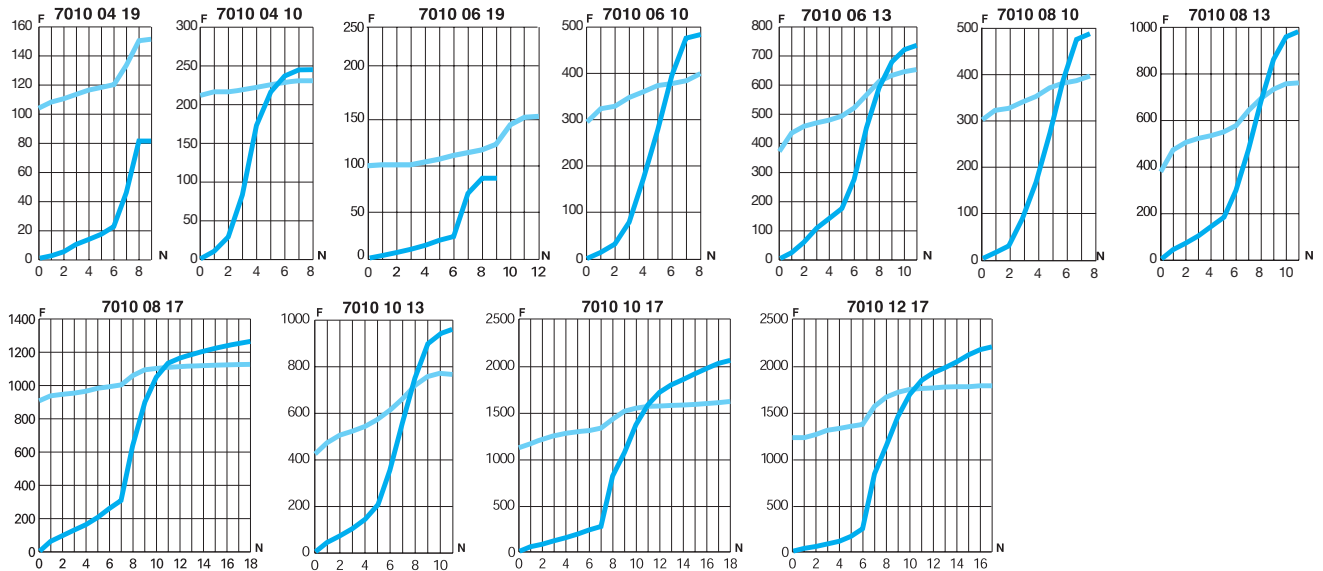

7011

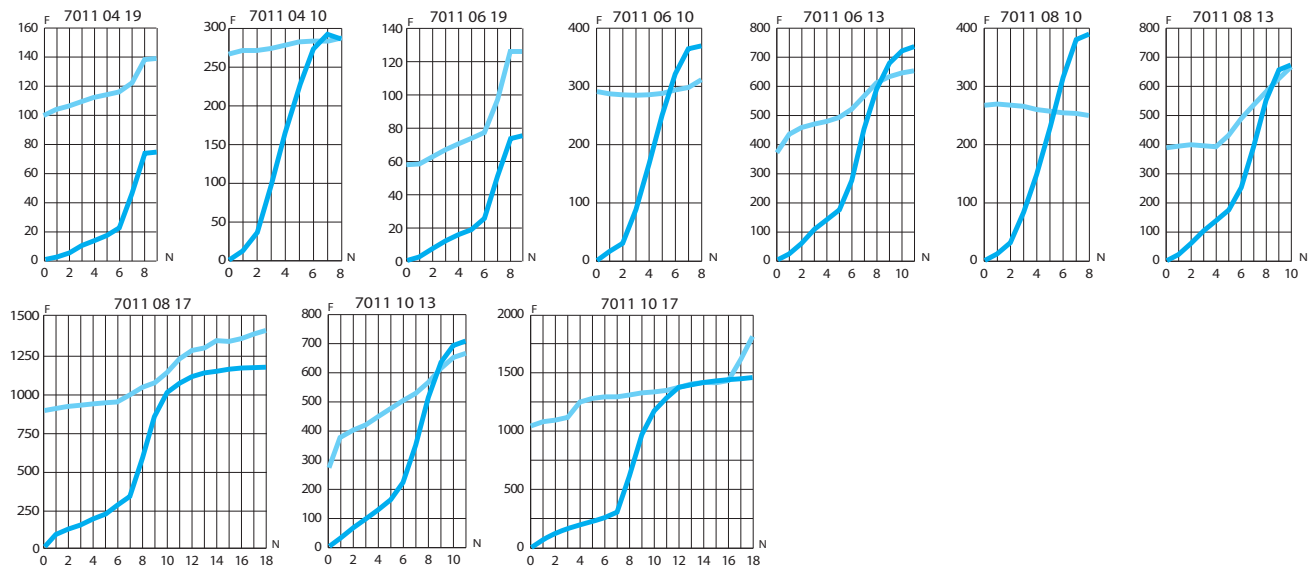

7012

Flow characteristics for model 7012:

- exhaust version (see model 7010, direction of adjustment)
- supply version (see model 7011, direction of adjustment)

6 bar

Direction of adjustment
 Return

F: Flow in NI/min

N: Number of turns

Flow Characteristics (at 6 bar)

for Flow Control Regulators



7060
7061
7062

7060

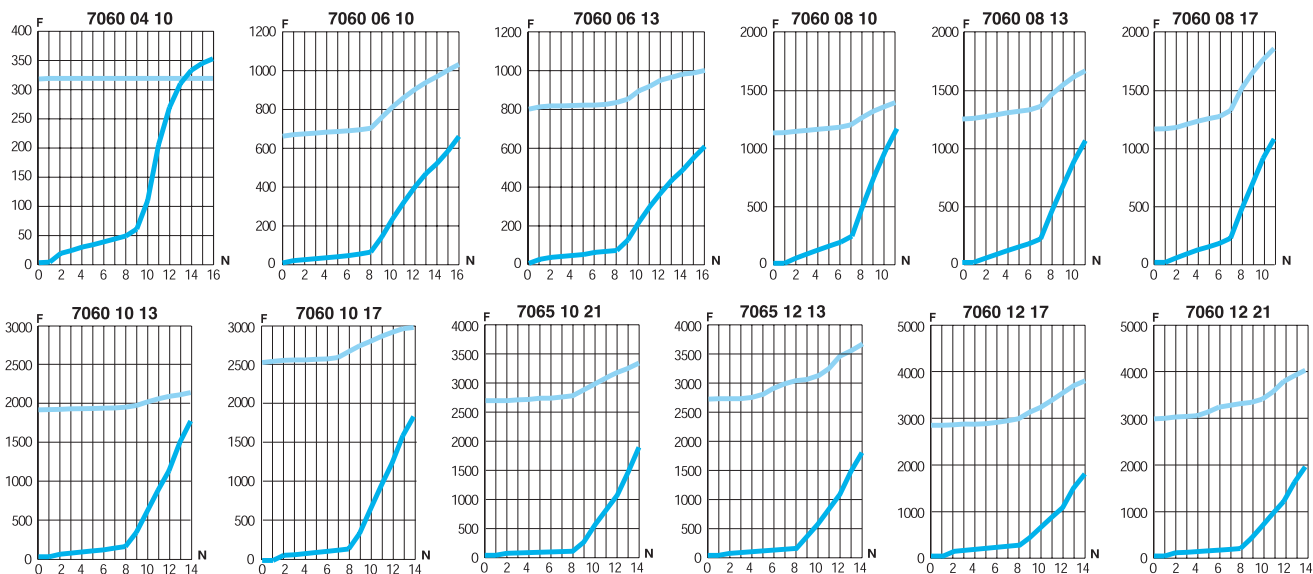

7061

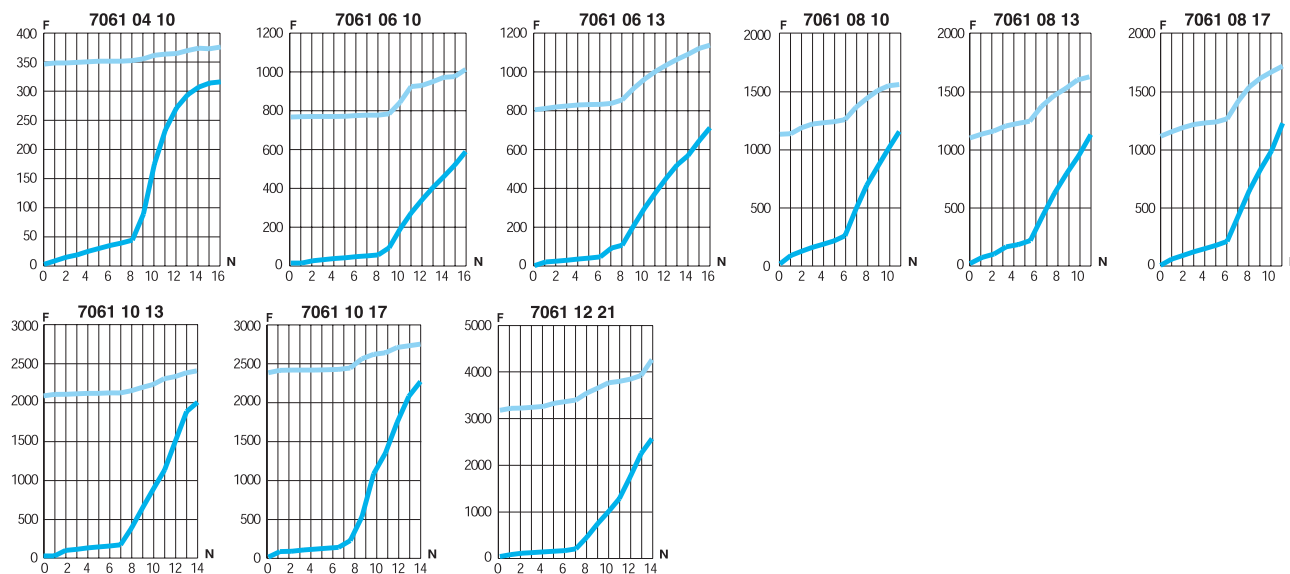

7062

Flow characteristics for model 7062:

- exhaust version (see model 7060, direction of adjustment)
- supply version (see model 7061, direction of adjustment)

Flow Characteristics (at 6 bar)

for Flow Control Regulators



7660
7669
7662

7660

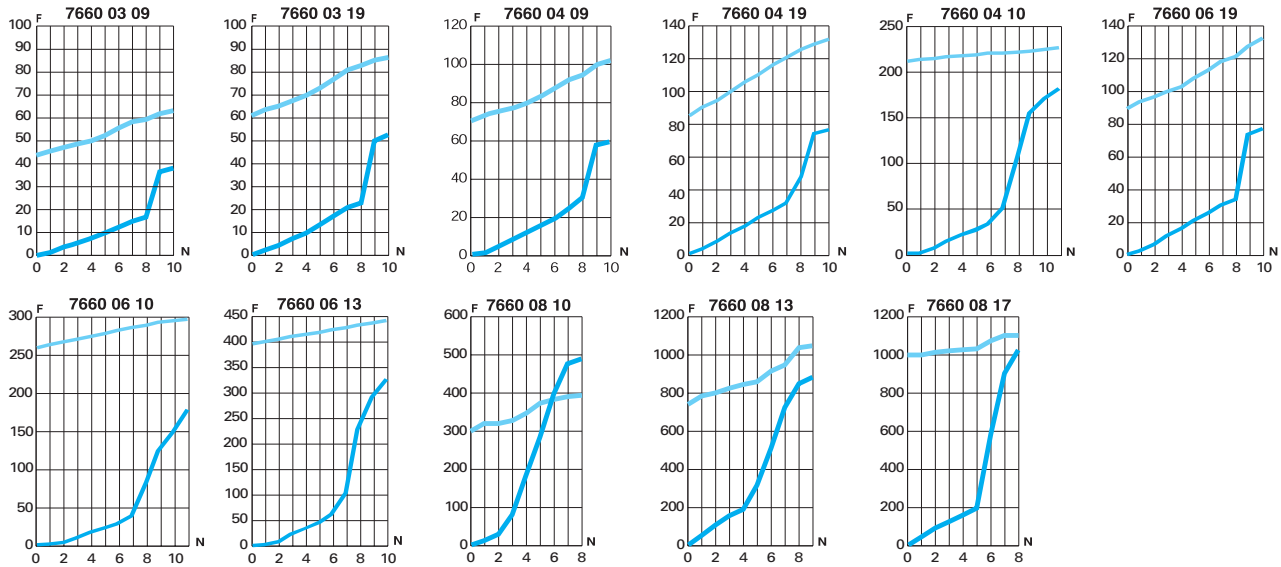

7669

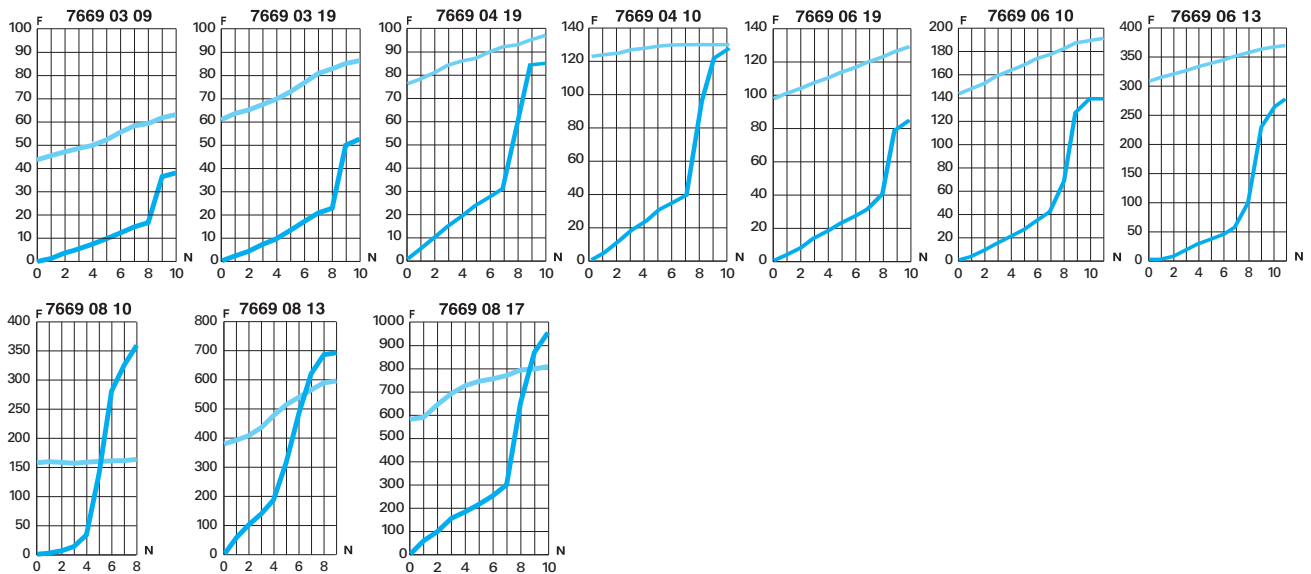

7662

Flow characteristics for model 7662:

- exhaust version: see model 7660, direction of adjustment
- supply version: see model 7669, direction of adjustment

6 bar

Direction of adjustment
 Return

F: Flow in NI/min

N: Number of turns

Flow Characteristics (at 6 bar)

for Flow Control Regulators



7640
7649

7640

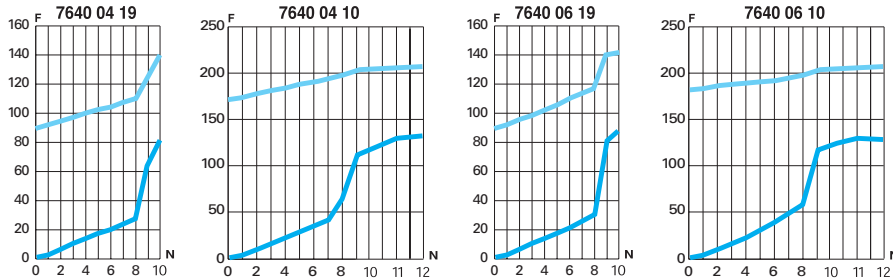

7649

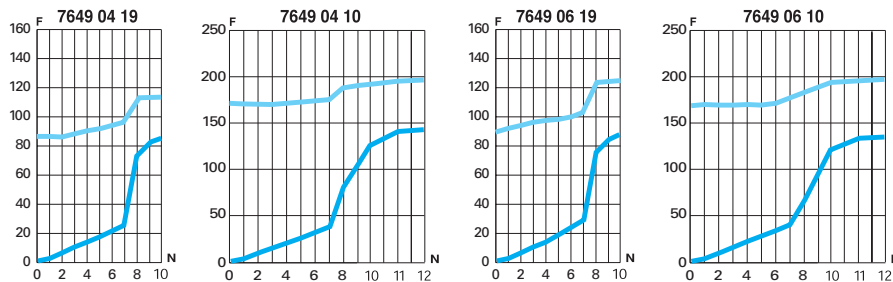

7771

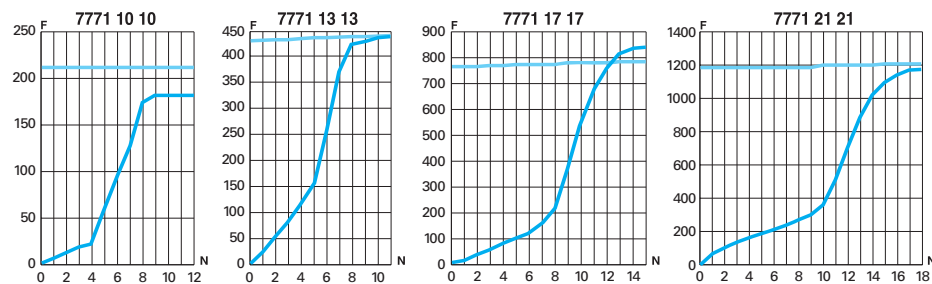

7020

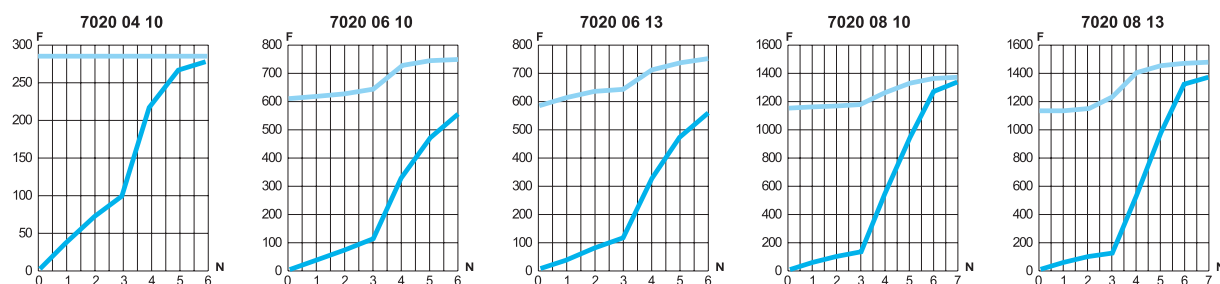

Flow Characteristics (at 6 bar)

for Flow Control Regulators



7770

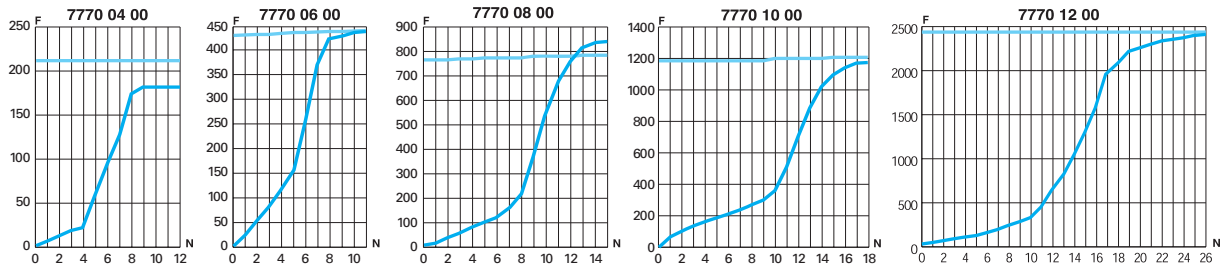

7776

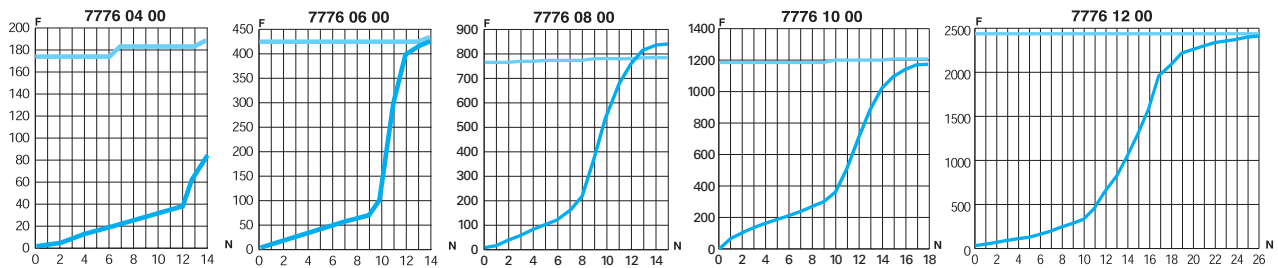

7030
7031

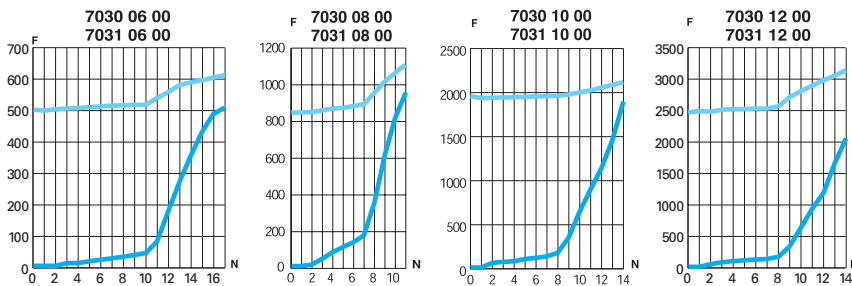

7630
7631

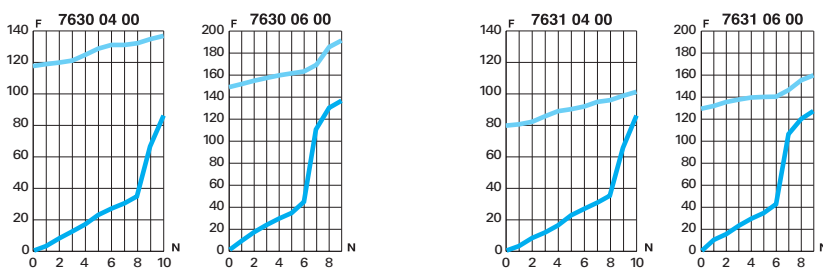

6 bar
 Direction of adjustment
 Return
F: Flow in NI/min
N: Number of turns

Flow Characteristics (at 6 bar)

for Flow Control Regulators



7065
7066
7067

7065

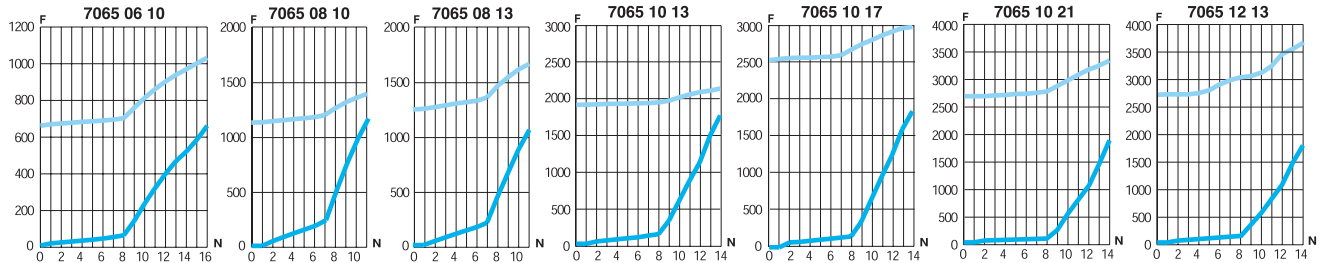

7066

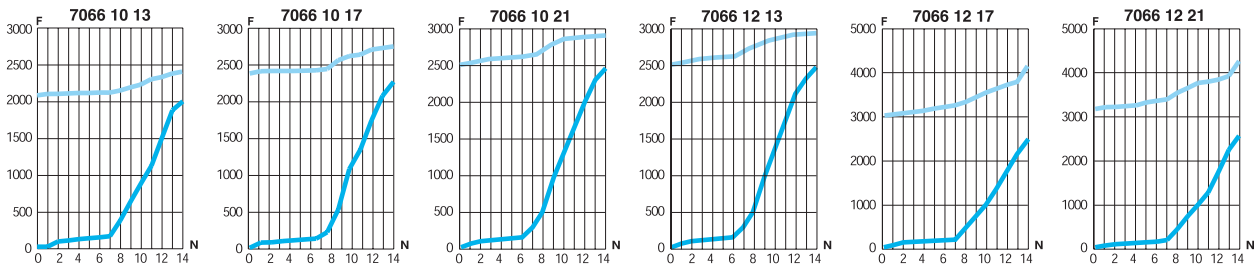

7067

Flow characteristics for model 7067:

- exhaust version: see model 7065, direction of adjustment
- supply version: see model 7066, direction of adjustment



7665
7668

7665

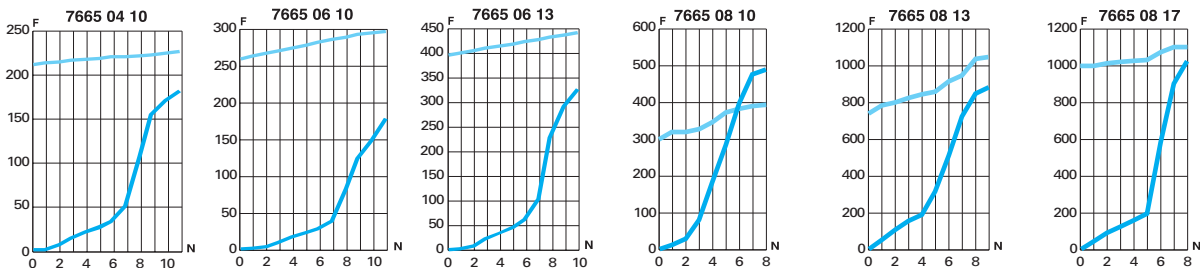

7668

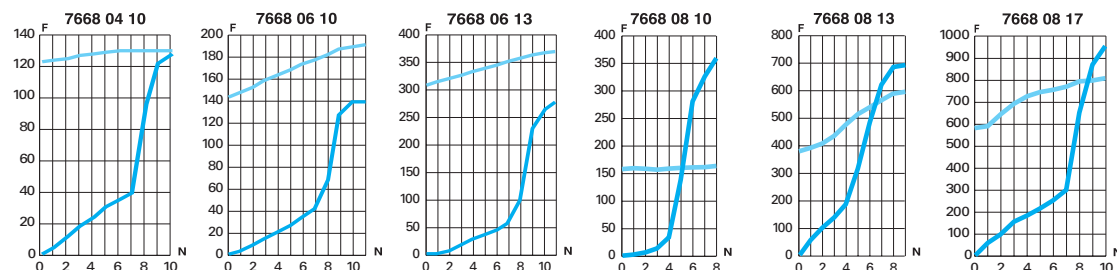

Flow Characteristics (at 6 bar)

for Flow Control Regulators



7045

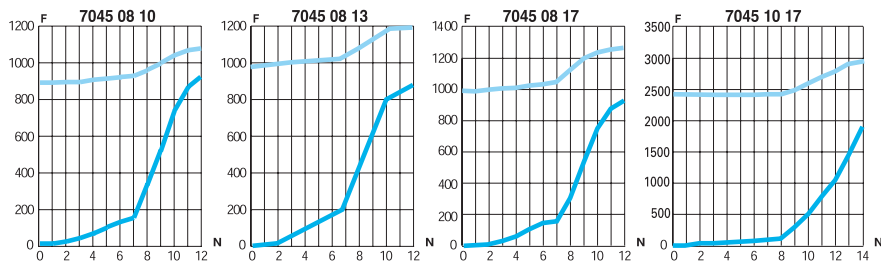

7130

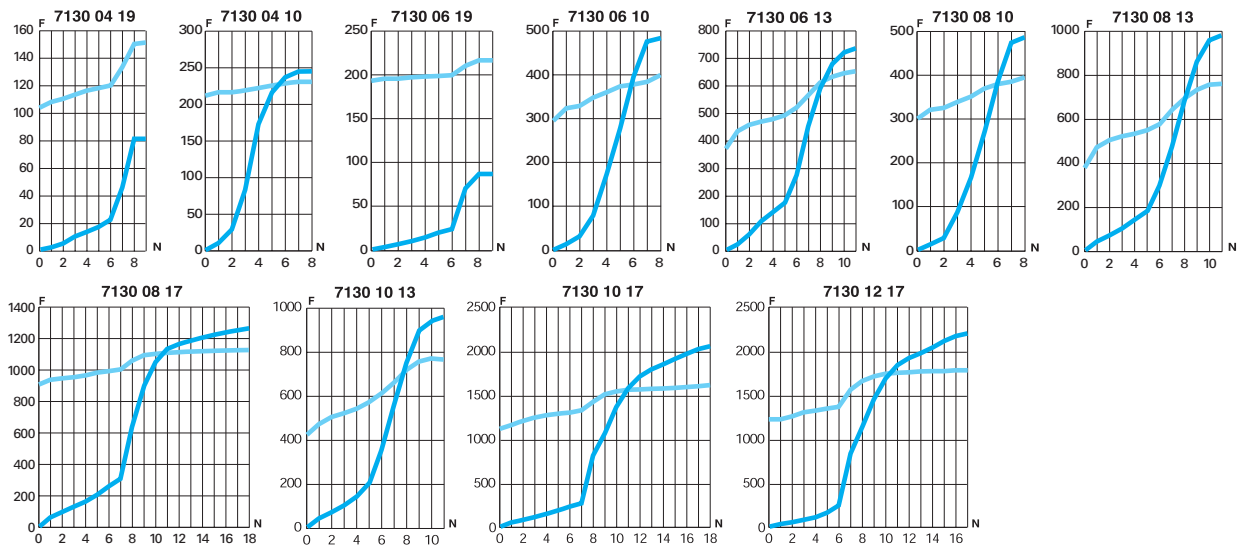

6 bar

Direction of adjustment
 Return

F: Flow in NI/min

N: Number of turns

Flow Characteristics (at 6 bar)

for Flow Control Regulators



7140

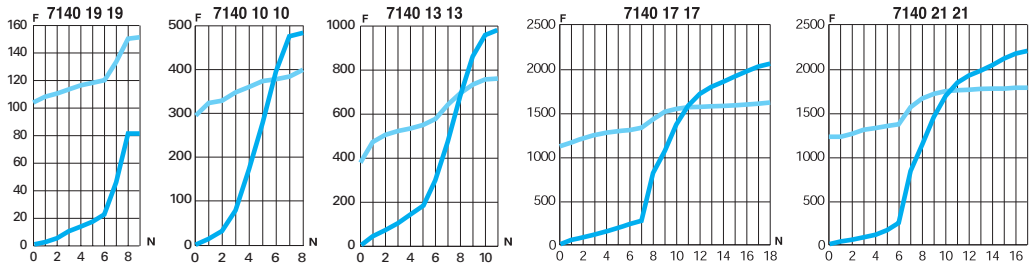

7160

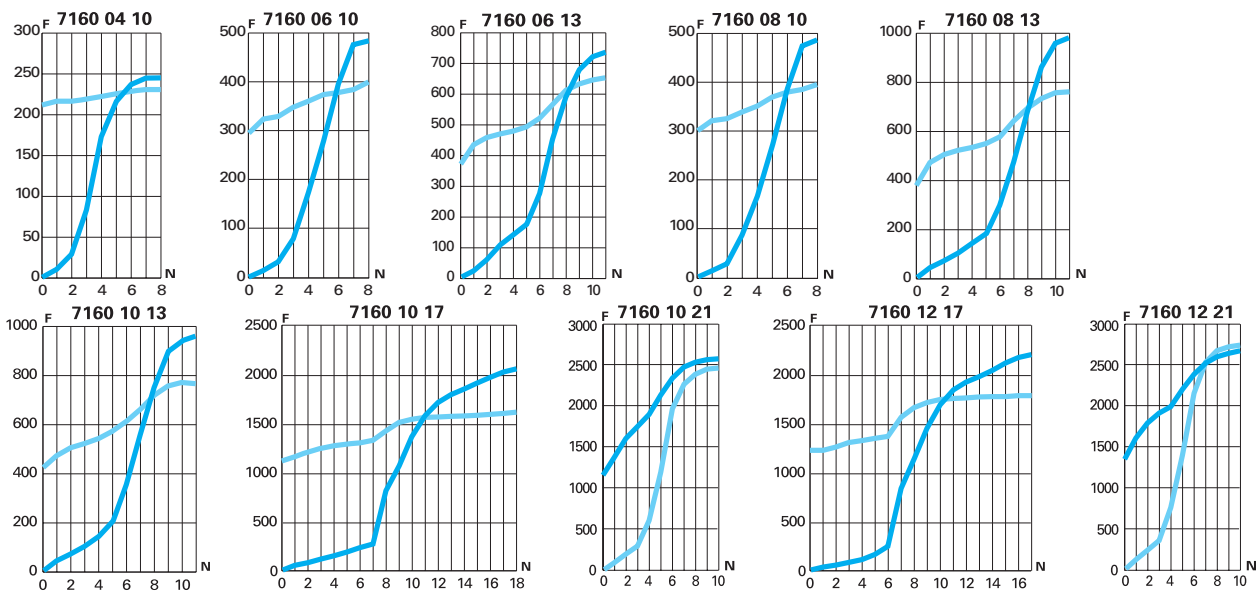

7762

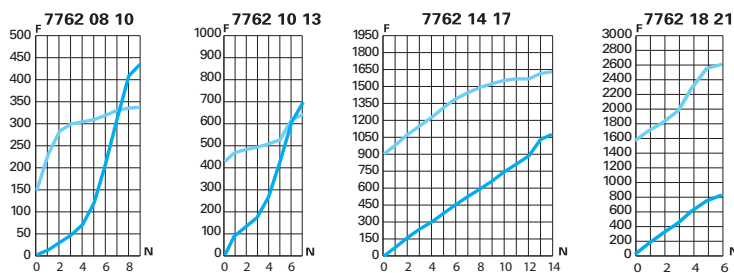

Flow Characteristics (at 6 bar) for Flow Control Regulators



7100
7101

7100

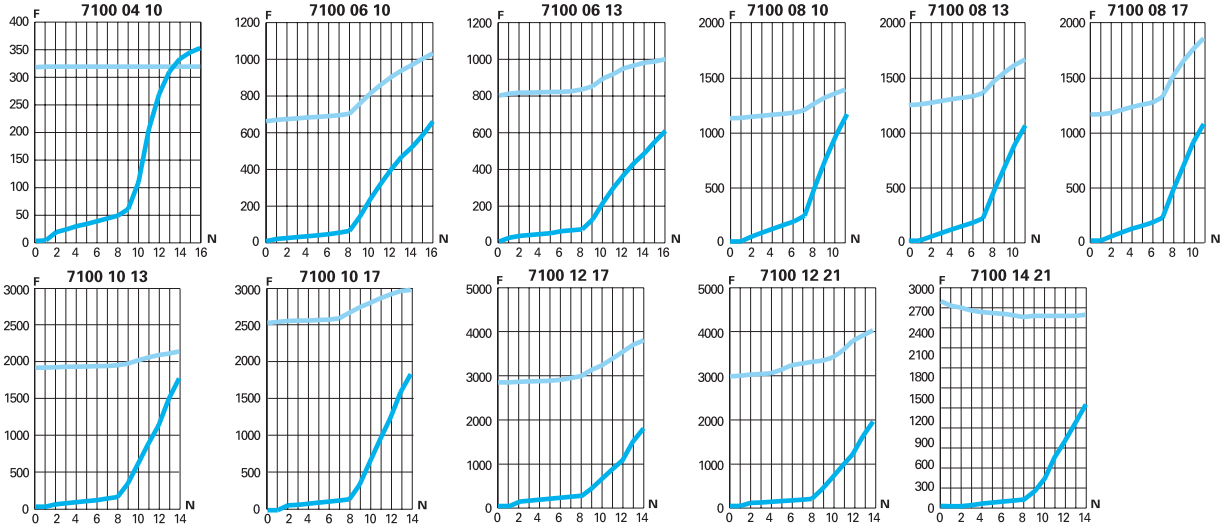

7101

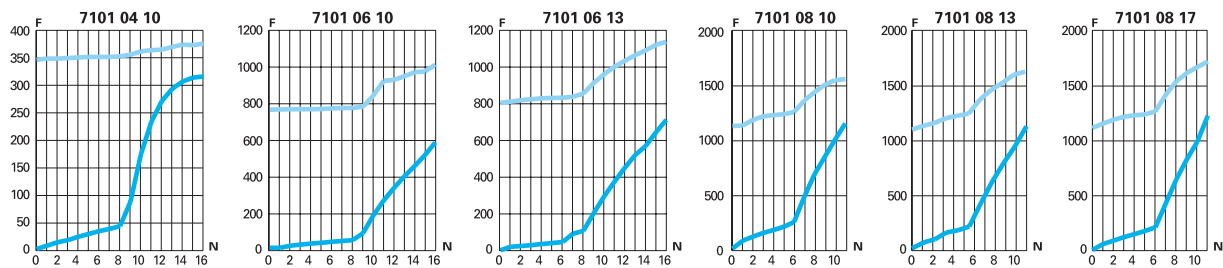

7680

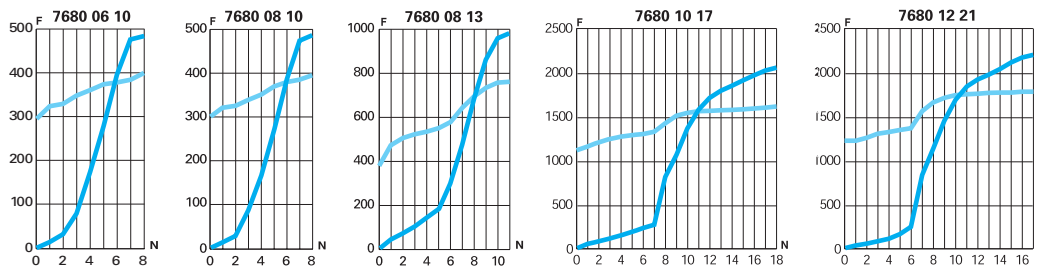

6 bar

Direction of adjustment
 Return
F: Flow in NI/min
N: Number of turns

Flow Characteristics (at 6 bar)

for Flow Control Regulators



7180

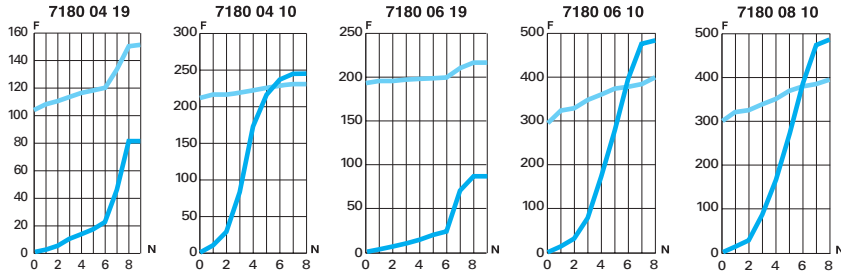

7110 7111

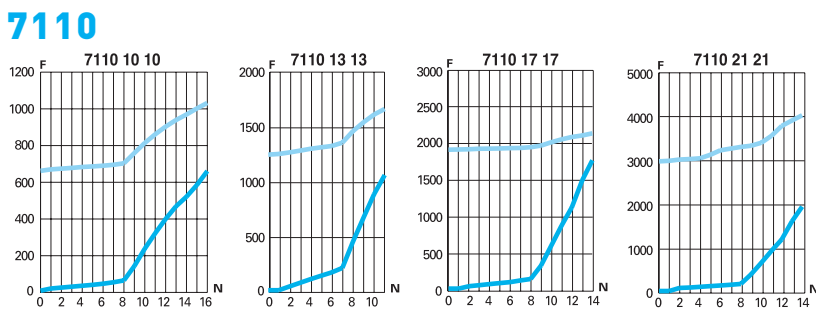

7111

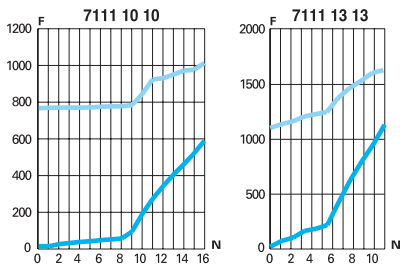

7170

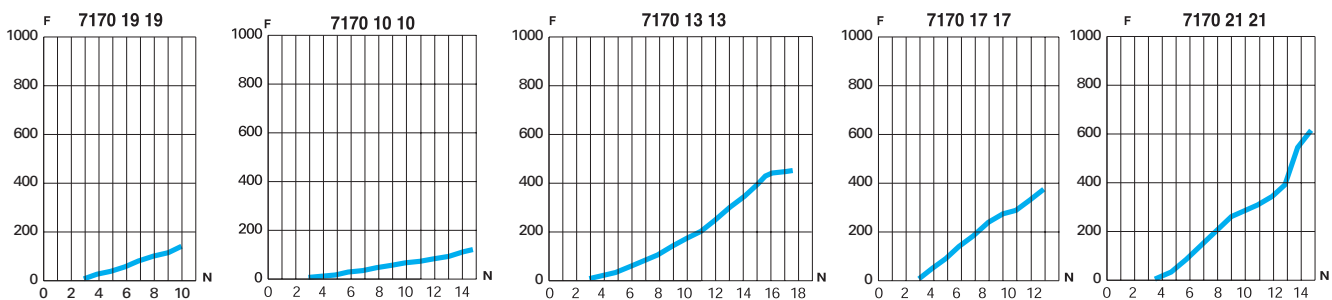

Function Fittings Range

Blocking Fittings

- 7880**
BSPP
Page 4-37
- 7881**
BSPP
Page 4-37
- 7885**
BSPT
Page 4-37
- 7886**
BSPT
Page 4-37
- 7883**
BSPP
Page 4-37



Piloted Non-Return Valves

- 7892**
BSPP
Page 4-39
- 7894**
BSPP
Page 4-39



Non-Return Valves

- 7996**
Page 4-41
- 7984**
7994
BSPP/Metric
Page 4-41
- 7985**
7995
BSPT
Page 4-41



Adjustable Non-Return Valves

- 7930**
BSPP/Metric
Page 4-43
- 7931**
BSPP
Page 4-43
- 7932**
BSPP
Page 4-43



LIQUIfit® Non-Return Valves

- 7992**
Page 4-45



Stainless Steel Non-Return Valves

- 4890**
BSPP
Page 4-47
- 4891**
BSPP
Page 4-47
- 4892**
BSPP
Page 4-47
- 4895**
NPT
Page 4-47



Soft Start Fittings

- 7860**
BSPP
Page 4-49
- 7870**
BSPP
Page 4-49
- 7861**
BSPP
Page 4-49
- 7871**
BSPP
Page 4-49



Pneumatic Sensor Fittings

- 7818**
BSPP/Metric
Page 4-51
- 7828**
BSPP/Metric
Page 4-51



Pressure Regulator Fittings

- 7300**
BSPP
Page 4-53



Pressure Reducer Fittings

- 7318**
BSPP
Page 4-55
- 7471**
BSPP
Page 4-55
- 7316**
Page 4-55
- 7416**
BSPP
Page 4-55
- 7000**
Page 4-55
- 7000**
Page 4-55



Snap Fittings

- 7926**
Page 4-57
- 7921**
BSPP
Page 4-57
- 7960**
Page 4-57
- 7961**
BSPP
Page 4-57



Manually-Operated Valves

- 7800**
7801
BSPP/Metric
Page 4-59
- 7802**
BSPP
Page 4-59
- 0669**
BSPP/Metric
Page 4-59



Function Fittings Range

Metal Quick Exhaust Valves

7970
BSPP/Metric
Page 4-61

7971
BSPP/BSPT
Page 4-61

7899
BSPP
Page 4-61



Silencers

0674
BSPP/Metric
Page 4-63

0676
BSPP/Metric
Page 4-63

0670
BSPP
Page 4-63

0673
BSPP/Metric
Page 4-63

0675
BSPP/Metric
Page 4-63

0671
Page 4-64

0677
BSPP
Page 4-64

0672
BSPP
Page 4-64

0682
BSPP
Page 4-64

0683
NPT
Page 4-64



Blocking Fittings

Blocking fittings, mounted in pairs on a cylinder, lock the piston by simultaneously **cutting off the supply and exhaust** when the pilot signal is removed.

Product Advantages

Optimum Performance

- Optimum flow: no effect on the performance of the cylinder
- Compact size
- Fully orientable for excellent flexibility in circuit installation
- 100% leak-tested in production
- Date coding to guarantee quality and traceability

Robust & Unsurpassed Life Time

- Suitable for the most demanding environments
- Excellent corrosion and spark resistance to salt spray and sparks (threaded models)
- Proven push-in technology
- Tried and tested durability according to DI 2006/42/CE



Robotics
Machine Tools
Textile
Packaging
Pneumatics
Automotive Process

Applications

Technical Characteristics

Compatible Fluids	Compressed air
Working Pressure	1 to 10 bar
Working Temperature	-20°C to +70°C -25°C to +70°C (metal version)

Connection	Supply Flow 6 bar	Pilot and depilot threshold depending on supply pressure					
		2 bar	4 bar	6 bar	8 bar	10 bar	
ØD 6 and 8 mm, threads G1/8, G1/4, R1/8, R1/4	650NI/min	Pilot Pressure	2.40	2.90	3.30	3.60	4.00
	650NI/min	Depilot Pressure	1.50	1.80	2.15	2.40	2.80
ØD 10 and 12 mm, threads G3/8, G1/2, R3/8, R1/2	1600NI/min	Pilot Pressure	2.70	3.20	3.50	3.80	4.10
	1600NI/min	Depilot Pressure	1.40	1.80	2.10	2.40	2.70

Reliable performance is dependent upon the type of fluid conveyed and component materials being used.

Use is guaranteed with a vacuum of 755 mm Hg (99% vacuum).

Component Materials

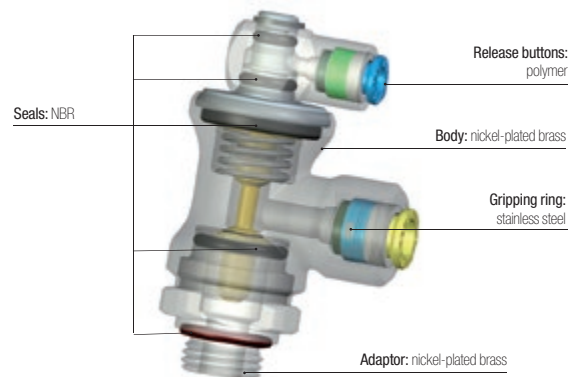

Silicone-free

Regulations

DI: 2002/95/EC (RoHS)
DI: 97/23/EC (PED)
RG: 1907/2006 (REACH)

DI: 2006/42/EC (Machine Directive)
test according to ISO 19973-5.
B10d (1Hz) >70 millions of cycles

Operation

Cylinder in Operation (pilot signal active)

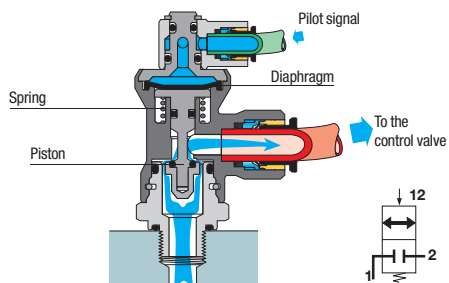

Pilot signal authorises movement

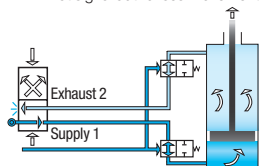

Cylinder Blocked (pilot signal removed)

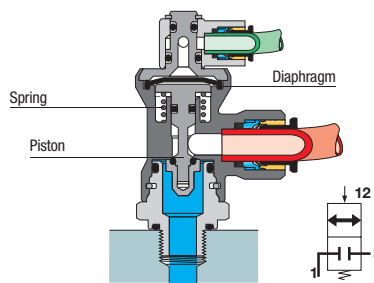

No signal blocks movement

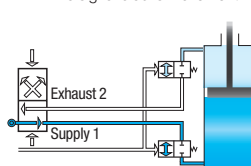

Installation

Mounted in pairs, blocking fittings are installed directly on the cylinder. Being fully orientable, they offer excellent flexibility in the design and installation of pneumatic circuits.

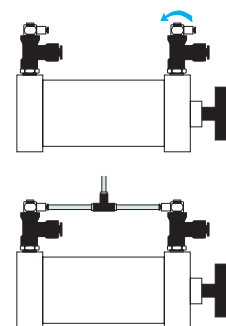

Blocking Fittings

7880 Blocking Fitting, Male BSPP Thread

Nickel-plated brass, NBR

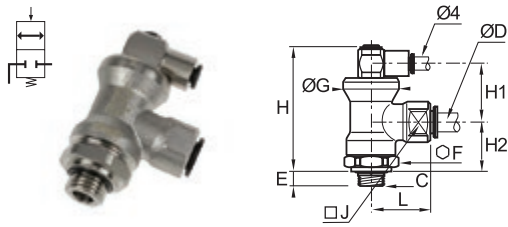

ØD	C		E	F	G	H	H1	H2	J	L	Kg
6	G1/8	7880 06 10	5.5	21	24	53	24.5	21	17	28	0.127
	G1/4	7880 06 13	6.5	21	24	53	24.5	21	17	28	0.130
8	G1/4	7880 08 13	6.5	21	24	53	24.5	21	17	28	0.124
	G3/8	7880 08 17	7.5	21	24	53	24.5	21	17	28	0.127
10	G3/8	7880 10 17	7.5	24	28	58	25	25	27	35	0.210
12	G1/2	7880 12 21	9	24	28	58	25	25	27	37.5	0.220

7885 Blocking Fitting, Male BSPT Thread

Nickel-plated brass, NBR

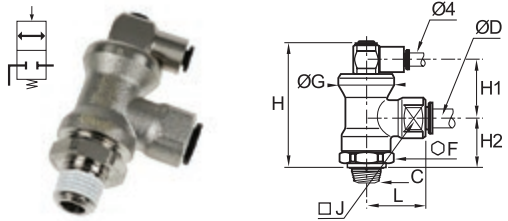

ØD	C		F	G	H	H1	H2	J	L	Kg
6	R1/8	7885 06 10	21	24	51.5	25	20	17	28	0.127
	R1/4	7885 06 13	21	24	51.5	25	20	17	28	0.131
8	R1/4	7885 08 13	21	24	51.5	25	20	17	28	0.126
	R3/8	7885 08 17	21	24	51.5	25	20	17	28	0.131
10	R3/8	7885 10 17	24	28	57	25	24	27	35	0.217
12	R1/2	7885 12 21	24	28	57	25	24	27	37.5	0.229

Pre-coated thread

7881 Blocking Fitting, Male/Female BSPP Thread

Nickel-plated brass, NBR

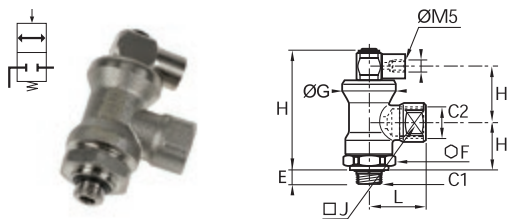

C1	C2		E	F	G	H	H1	H2	J	L	Kg
G1/8	G1/4	7881 13 10	5.5	21	24	53	24.5	21	17	25.5	0.119
G1/4	G1/4	7881 13 13	6.5	21	24	53	24.5	21	17	25.5	0.120
G3/8	G3/8	7881 17 17	7.5	24	28	58	25	25	27	34	0.208
G1/2	G1/2	7881 21 21	9	24	28	58	25	25	27	40	0.221

7886 Blocking Fitting, Male/Female BSPT Thread

Nickel-plated brass, NBR

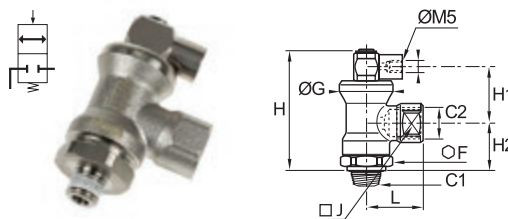

C1	C2		F	G	H	H1	H2	J	L	Kg
R1/8	R1/4	7886 13 10	21	24	51.5	25	20	17	26.5	0.121
R1/4	R1/4	7886 13 13	21	24	51.5	25	20	17	26.5	0.126
R3/8	R3/8	7886 17 17	24	28	57	25	24	27	34	0.225
R1/2	R1/2	7886 21 21	24	28	57	25	24	27	40	0.235

Pre-coated thread

7883 Blocker/Flow Regulator, Male BSPP Thread

Nickel-plated brass, technical polymer, NBR

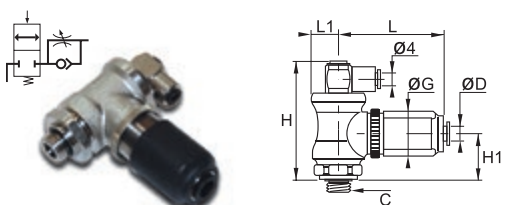

ØD	C		G	H	H1	L	L _{max}	L1	Kg
4	G1/8	7883 04 10	21.5	53	21	46.5	52	12	0.166
	G1/4	7883 06 10	21.5	53	21	46.5	52	12	0.163
6	G1/4	7883 06 13	21.5	53	21	46.5	52	12	0.166
	G1/4	7883 08 13	27	57.5	24.5	54	60	14	0.252
8	G3/8	7883 08 17	27	57.5	24.5	54	60	14	0.254

Combination of blocking and flow regulation functions

Working temperature: 0 to +70°C

Piloted Non-Return Valves

Piloted non-return valves are designed to **protect installations**: if the compressed air supply is removed, they lock the air supply to the cylinder, thus maintaining it in position.

Product Advantages

- System Protection**
 - Protection of your system
 - Control of inlet and outlet flow: cylinder operation optimised
 - Vent saves time on restart after maintenance operations (model 7894)
- 3 Functions in 1 Product**
 - A multi-purpose fitting:
 - piloted non-return valve
 - flow control regulator
 - manual exhaust
 - All-in-one product: integrated fittings for the control and supply
- Flexible Operation**
 - Orientable and adjustable through 3 axes
 - Can be integrated into any installation configuration
 - Push-in connection for quicker and more reliable installation
 - Mounted in pairs directly on the cylinder



Applications

Pneumatics
Assembly
Robotics
Machine Tools
Packaging
Handling
Automotive Process

Technical Characteristics

Compatible Fluids	Compressed air
Working Pressure	1 to 10 bar
Working Temperature	-5°C to +60°C
Cracking Pressure	0.3 bar

Regulations

DI: 2002/95/EC (RoHS)
RG: 1907/2006 (REACH)
DI: 97/23/EC (PED)

Component Materials

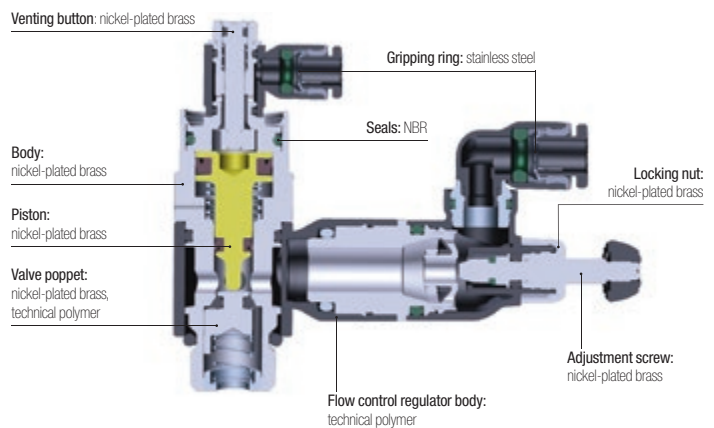

Silicone-free

Operation

Normal Operation

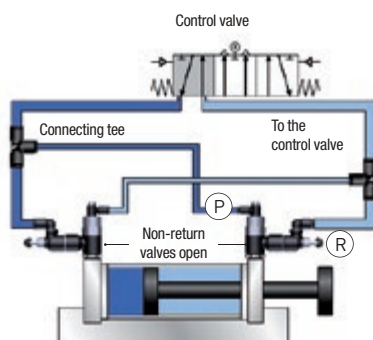

Pilot signal (P)
Regulation of cylinder rod speed (R)

Emergency Stop or Pressure Drop

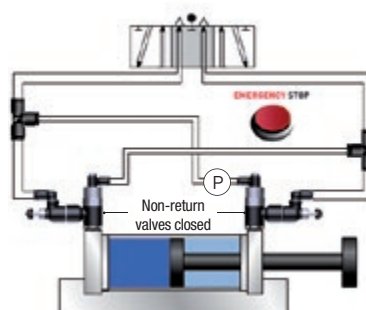

Drop/removal of pilot pressure (P) = cylinder rod locked

Venting Operation

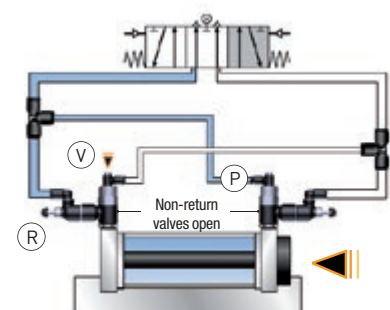

Venting (V) returns the cylinder rod to the to start position, emptying the pressure chamber through the flow regulator (R) and pilot line (P)

Piloted Non-Return Valves

7892 Piloted Non-Return Valve, Male BSPP Thread

Technical polymer, nickel-plated brass, NBR

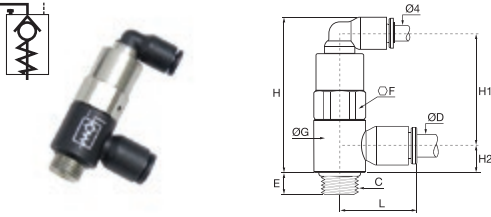

ØD	C		E	F	G	H	H1	H2	L	Kg
6	G1/8	7892 06 10	6	13	14	42	30	7	21	0.020
	G1/4	7892 06 13	9	17	18.5	45	32	9	23	0.042
8	G1/8	7892 08 10	6	13	14	42	29	9	25	0.020
	G1/4	7892 08 13	9	17	18.5	45	32	9	27	0.042
10	G3/8	7892 08 17	6	20	22.5	57	41	11	28	0.093
	G1/2	7892 10 17	6	20	22.5	57	41	11	31	0.144
12	G1/2	7892 10 21	10	24	28	63	47	16	36	0.109
	G1/2	7892 12 21	10	24	28	63	47	16	36	0.150

7894 Piloted Non-Return Valve with Flow Regulator and Exhaust, Male BSPP Thread

Technical polymer, nickel-plated brass

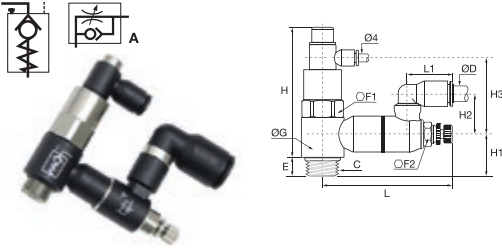

ØD	C		E	F1	F2	G	H	H1	H2	H3	L	L _{max}	L1	Kg
6	G1/8	7894 06 10	6	13	8	14	46	7	24	31	48.5	51	16	0.041
	G1/4	7894 06 13	9	17	10	18.5	49	11	18	31	59.5	65	17	0.067
8	G1/8	7894 08 10	6	13	8	14	46	7	27	31	48.5	51	22	0.051
	G1/4	7894 08 13	9	17	10	18.5	49	11	23	31	59.5	65	23	0.068
10	G3/8	7894 08 17	7	20	14	22.5	69	13	21	40	67.5	73	23	0.060
	G1/2	7894 10 17	7	20	14	22.5	69	13	29	40	67.5	73	26	0.061
12	G1/2	7894 10 21	9	24	17	28	76	12.5	26	47	74	81	26	0.234
	G1/2	7894 12 21	9	24	17	28	76	12.5	27	47	74	81	30	0.237

Related Product

LF 3000® Push-In Fittings

Unequal Tee

P. 1-18



Model		Pilot and depilot threshold				
		2 bar	4 bar	6 bar	8 bar	10 bar
G1/8	Pilot Pressure	1.2	1.72	2.44	2.96	3.56
	Depilot Pressure	0.56	0.96	1.12	1.76	2.12
G1/4	Pilot Pressure	0.92	1.52	2.12	2.68	3.28
	Depilot Pressure	0.64	1.16	1.68	2.16	2.64
G3/8	Pilot Pressure	1.12	1.84	2.56	3.32	4.08
	Depilot Pressure	0.64	1.04	1.44	1.84	2.36
G1/2	Pilot Pressure	1.04	1.60	2.12	2.76	3.88
	Depilot Pressure	0.76	1.28	1.76	2.20	2.72

Maximum Flow at 6 bar (Nl/min)	7894 06 10	7894 06 13	7894 08 10	7894 08 13	7894 08 17	7894 10 17	7894 10 21	7894 12 21
Direction of Adjustment	250	475	240	585	875	940	1535	1560
Return	365	620	355	815	1085	1205	1860	1940

Non-Return Valves

Non-return valves allow compressed air to flow in one direction and prevent it from flowing in the other. Fitted upstream of the circuit to be protected, they provide **total protection**.

Product Advantages

- Variety of Applications**
 - Wide range
 - Push-in connection: ease of use
 - Available in threaded or push-in version
- Powerful Design**
 - Tried and tested durability according to DI 2006/42/CE
 - Lip seals for improved sealing performance
 - Excellent vibration resistance
 - Compact
 - Lightweight
 - Symbol showing the operating direction of flow
 - Safe installation with colour codes:
 - green push-button: supply version
 - red push-button: exhaust version



Applications

- Automotive Process
- Robotics
- Vacuum
- Textile
- Semi-Conductors
- Packaging
- Pneumatics

Technical Characteristics

Compatible Fluids	Compressed air	
Working Pressure	1 to 10 bar	
Working Temperature	0°C to +70°C	
Cracking Pressure	0.3 bar	
Flow Characteristics (NI/min)	Model	Flow at 6 bar
	4 mm	350
	6 mm	670
	8 mm	1080
	10 mm	2230
12 mm	2300	

Component Materials

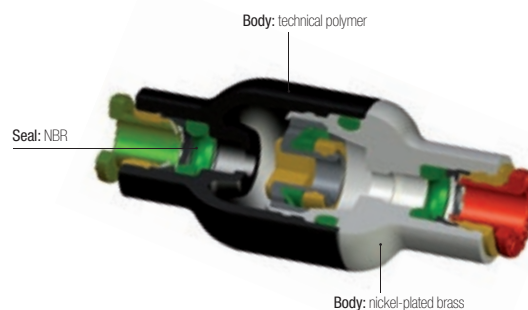

Silicone-free

Regulations

DI: 2002/95/EC (RoHS)
 RG: 1907/2006 (REACH)
 DI: 97/23/EC (PED)

DI : 2006/42/EC (Machine Directive)
 test according to ISO 19973-5, B10d (1Hz)
 >40 millions of cycles

Operation

In-Line Version

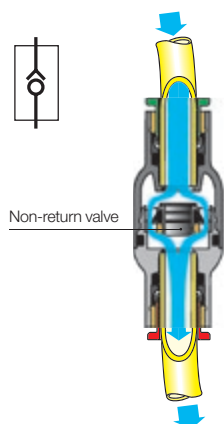

Supply Version

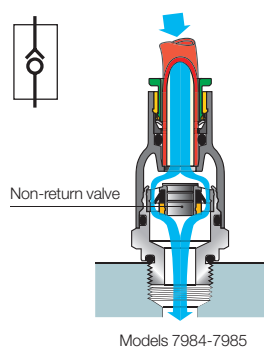

Exhaust Version

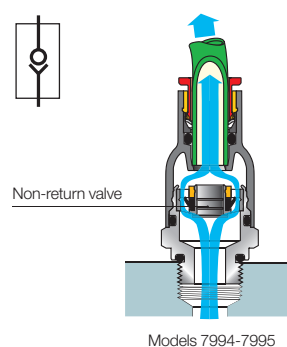

Installation Diagram

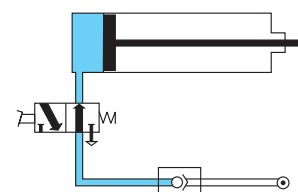

Non-Return Valves

7996 In-Line Equal Non-Return Valve



Technical polymer, nickel-plated brass, NBR

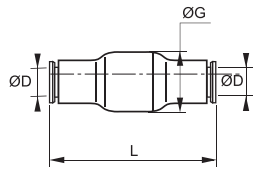

ØD		G	L	Kg
4	7996 04 00	16	38.5	0.008
6	7996 06 00	16	41	0.013
8	7996 08 00	19	51.5	0.017
10	7996 10 00	23	63.5	0.070
12	7996 12 00	23	66.5	0.050

7984 In-Line Non-Return Valve, Supply, Male BSPP and Metric Thread



Technical polymer, nickel-plated brass, NBR

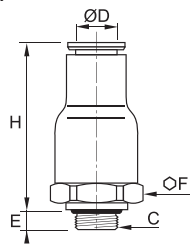

ØD	C		E	F	H	Kg
4	M5x0.8	7984 04 19	3	9	32	0.008
	G1/8	7984 04 10	5	16	28.5	0.015
6	G1/4	7984 06 13	5.5	16	30.5	0.015
	G1/8	7984 08 10	5	19	36	0.021
8	G1/4	7984 08 13	5.5	19	36	0.023
	G3/8	7984 10 17	5.5	23	42	0.047
12	G3/8	7984 12 17	5.5	23	42	0.010
	G1/2	7984 12 21	7.5	23	44	0.041

7994 In-Line Non-Return Valve, Exhaust, Male BSPP and Metric Thread



Technical polymer, nickel-plated brass, NBR

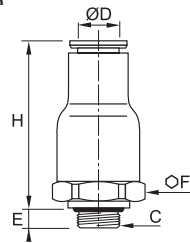

ØD	C		E	F	H	Kg
4	M5x0.8	7994 04 19	3	9	32	0.790
	G1/8	7994 04 10	5	16	28.5	0.018
6	G1/8	7994 06 10	5	16	30.5	0.015
	G1/4	7994 06 13	5.5	16	30.5	0.015
8	G1/8	7994 08 10	5	19	36	0.023
	G1/4	7994 08 13	5.5	19	36	0.023
10	G3/8	7994 10 17	5.5	23	42	0.050
	G3/8	7994 12 17	5.5	23	42	0.043
12	G1/2	7994 12 21	7.5	23	44	0.045

7985 In-Line Non-Return Valve, Supply, Male BSPT Thread



Technical polymer, nickel-plated brass, NBR

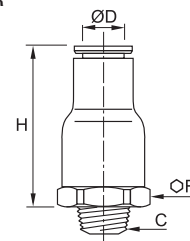

ØD	C		F	H	Kg
4	R1/8	7985 04 10	16	28.5	0.016
	R1/8	7985 06 10	16	30.5	0.016
6	R1/4	7985 06 13	16	30.5	0.021
	R1/8	7985 08 10	19	36	0.022
8	R1/4	7985 08 13	19	36	0.020
	R3/8	7985 10 17	23	42	0.049
12	R3/8	7985 12 17	23	42	0.042
	R1/2	7985 12 21	23	44	0.048

Pre-coated thread

7995 In-Line Non-Return Valve, Exhaust, Male BSPT Thread



Technical polymer, nickel-plated brass, NBR

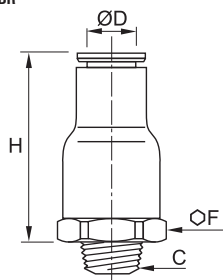

ØD	C		F	H	Kg
4	R1/8	7995 04 10	16	28.5	0.015
	R1/8	7995 06 10	16	30.5	0.016
6	R1/4	7995 06 13	16	30.5	0.022
	R1/8	7995 08 10	19	36	0.022
8	R1/4	7995 08 13	19	36	0.026
	R3/8	7995 10 17	23	42	0.048
12	R3/8	7995 12 17	23	42	0.042
	R1/2	7995 12 21	23	44	0.048

Pre-coated thread

Nickel-Plated Brass Adjustable Non-Return Valves

These nickel-plated brass adjustable non-return valves, suitable for **harsh environments**, allow compressed air to flow in one direction and prevent flow in the other. This product incorporates **precise adjustment** of opening pressure for greater flexibility.

Product Advantages

- Robust** | Excellent resistance to abrasion and corrosion
Developed for the food process industry
- Optimised Inventory Management** | A single valve for multiple opening pressure settings
Limits the number of versions
Flexibility of use
- Protection & Safety** | Maintains downstream pressure if upstream pressure drops
Designed with locking nut to protect initial setting in the event of:
 - vibration
 - intensive use
 - accidental handling
 Adjustment and locking of the non-return valve cracking pressure with two different Allen keys prevents the settings from being accidentally changed
Smooth external profile to facilitate cleaning in situ
Maximum constant flow guaranteed whatever the setting of the cracking pressure



Applications

Printing
Machine Tools
Food Process
Petrochemical
Textile
Automotive Process
Chemical

Technical Characteristics

Compatible Fluids	Compressed air					
Working Pressure	0 to 12 bar					
Working Temperature	-20°C to +80°C					
Cracking Pressure	Threads	0 to 4 turns (values given as an example only)				
	M5x0.8 - G1/8 - G1/4	1 to 0.10 bar				
	G3/8	1 to 0.15 bar				
	G1/2	1 to 0.20 bar				
Max. Tightening Torques	Threads	M5x0.8	G1/8	G1/4	G3/8	G1/2
	daN.m	0.16	0.8	1.2	3	3.5

Component Materials

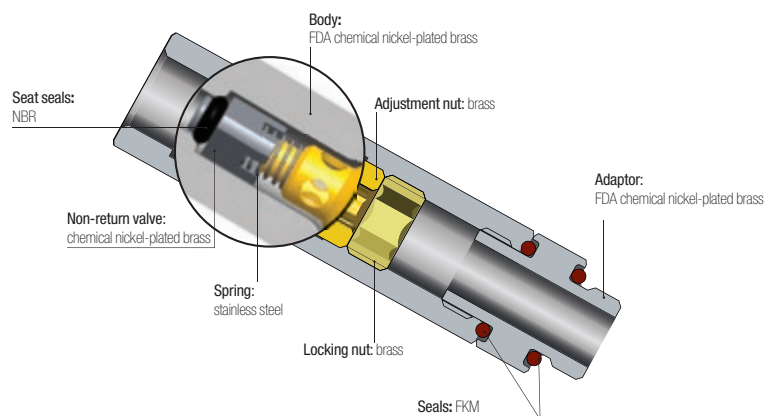

Silicone-free

Regulations

DI: 2002/95/EC (RoHS)
 RG: External Components: 21CFR (FDA)
 (seal: § 177.2600, nickel: §184.1537, grease: NSF H1)
 RG: 1935/2004 (external surface flow \geq 0.02 litre per hour)

DI: 2006/42/EC (external surface Ra < 0.8 μ m)
 RG: 1907/2006 (REACH)
 DI: 2006/42/EC (Machine Directive) test according to ISO 19973-5.
 B10d (1Hz) >70 millions of cycles

Operation

Step 1

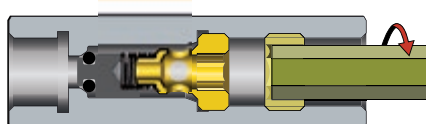

Unscrew the locking nut with an Allen key.

Step 2

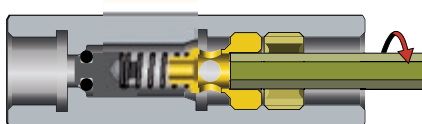

Unscrew the adjustment nut with a smaller Allen key to adjust the cracking pressure. The number of turns adjusts the cracking pressure from 1 bar to 0.10 bar.

Step 3

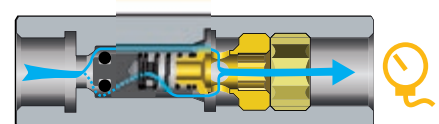

Tighten the locking nut with the Allen key to lock the cracking pressure setting. Then, control the pressure with a pressure gauge downstream.

Nickel-Plated Brass Adjustable Non-Return Valves

7930 Adjustable Check Valve, Double Female BSPP and Metric Thread

FDA chemical nickel-plated brass, FKM

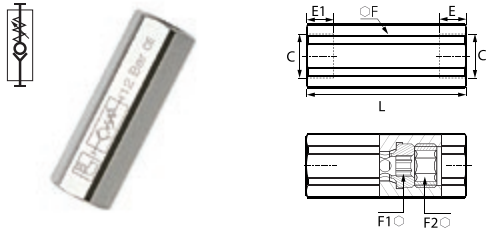

C		E	E1	F	F1	F2	L	Kg
M5x0.8	7930 19 19	8	4	13	4	6	49	0.055
G1/8	7930 10 10	8	6	13	4	6	45	0.033
G1/4	7930 13 13	10	7.5	16	6	8	54	0.073
G3/8	7930 17 17	11	8.5	20	8	10	61.5	0.163
G1/2	7930 21 21	13	10	24	10	12	73	0.171

7931 Adjustable Check Valve Supply, Male/Female BSPP Thread

FDA chemical nickel-plated brass, FKM

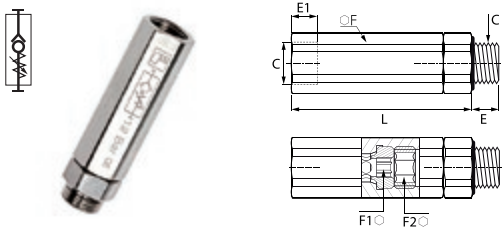

C		E	E1	F	F1	F2	L	Kg
G1/8	7931 10 10	5.5	6	13	4	6	51.5	0.043
G1/4	7931 13 13	6.5	7.5	16	6	8	61.5	0.208
G3/8	7931 17 17	7.5	8.5	20	8	10	70	0.125
G1/2	7931 21 21	9	10	24	10	12	82.5	0.212

7932 Adjustable Check Valve Exhaust, Male/Female BSPP Thread

FDA chemical nickel-plated brass, FKM

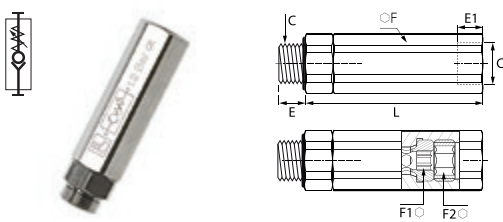

C		E	E1	F	F1	F2	L	Kg
G1/8	7932 10 10	5.5	8	13	4	6	51.5	0.009
G1/4	7932 13 13	6.5	10	16	6	8	61.5	0.058
G3/8	7932 17 17	7.5	11	20	8	10	70	0.123
G1/2	7932 21 21	9	13	24	10	12	82.5	0.212

LIQUIfit® Non-Return Valves

LIQUIfit® non-return valves meet the requirements for conveying **beverages**. They allow flow in one direction and prevent any return flow. Fitted in the circuit, they provide **total protection**.

Product Advantages

Suitable for Beverage Applications

Fully compatible for use with water, beverages and liquid foodstuffs (liquids and gas)
 Very low cracking threshold
 Excellent chemical compatibility
 Resistant to cleaning products
 Hygienic design with smooth surfaces
 Fluid direction indicated
 EPDM sealing technology



Water Softeners
 Water Treatment
 Water Purification
 Drinks Dispensers
 Hot & Cold Water Systems

Applications

Technical Characteristics

Compatible Fluids	Water, beverages, liquid foodstuffs
Working Pressure	1 to 10 bar
Working Temperature	0°C to +65°C
Cracking Pressure	0.02 bar

Component Materials



Silicone-free

Regulations

DI: 2002/95/EC (RoHS), 2011/65/EC
 FDA: 21 CFR 177.1550
 NSF 51 (referenced material)
 NSF 61
 RG: 1907/2006 (REACH)

LIQUIfit® Non-Return Valves

7992

Single Non-Return Valve



POM, EPDM

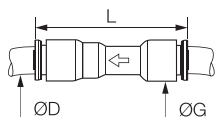

ØD		G	L	Kg
1/4	7992 56 00WP2	17	51	0.008
5/16	7992 08 00WP2	18	53	0.010
3/8	7992 60 00WP2	20	55	0.011
1/2	7992 62 00WP2	23	68	0.021

Associated Products

The full range of LIQUIfit® products can be found in this catalogue:

- Push-in fittings for metric and inch tubing (Chapter 1)
- Valves (Chapter 6)

To complement the LIQUIfit® range, Parker Legris Advanced PE tubing (Chapter 3) is suited to the most demanding environments, approved for permanent contact with beverage and food products, as well as for water treatment.

Stainless Steel Non-Return Valves

Stainless steel non-return valves are ideally suited to **harsh environments** and for conveying **many industrial fluids**. These products allow fluids to flow in one direction and prevent them from flowing in the other.

Product Advantages

Demanding Environments | Robust design
 Suitable for use with many chemicals or in corrosive environments
 Compatible with many fluids

Compact & Versatile | Reduced dimensions
 Smooth external surfaces contribute to equipment cleanliness
 Flow direction symbol protects against incorrect installation
 Hexagonal body to facilitate installation



Pneumatics
 Machine Tools
 Food Process
 Printing
 Chemical
 Textile
 Automotive Process

Applications

Technical Characteristics

Compatible Fluids	Many fluids
Working Pressure	0.5 to 40 bar
Working Temperature	-20°C to +180°C

Flow Characteristics	Threads	NI/min	Kv
	G1/8	18.88	1.60
	G1/4	19.91	1.69
	G3/8	35.54	3.01
	G1/2	36.50	3.10
	G3/4	65.86	5.59
G1	92.60	7.86	

Cracking Pressure	0.25 bar
--------------------------	----------

Component Materials

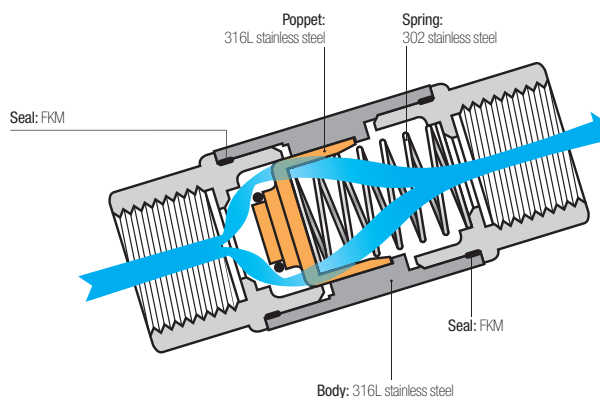

Silicone-free

Regulations

DI: 2002/95/EC (RoHS)
 RG: 1907/2006 (REACH)
 DI: 97/23/EC (PED)

Stainless Steel Non-Return Valves

4890 Non-Return Valve, Female BSPP Thread



Stainless steel 316L, FKM

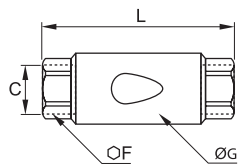

C	DN		F	G	L	Kg
G1/8	10	4890 10 10	17	22	50	0.082
G1/4	10	4890 13 13	17	22	50	0.074
G3/8	15	4890 17 17	22	30	67	0.182
G1/2	15	4890 21 21	24	30	71	0.183
G3/4	20	4890 27 27	32	42	84	0.289
G1	25	4890 34 34	38	42	90	0.420

4891 Non-Return Valve, Supply, Male BSPP Thread/Exhaust, Female BSPP Thread



Stainless steel 316L, FKM

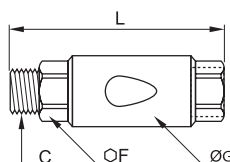

C	DN		F	G	L	Kg
G1/8	10	4891 10 10	17	22	56	0.100
G1/4	10	4891 13 13	17	22	58	0.082
G3/8	15	4891 17 17	22	30	75	0.191
G1/2	15	4891 21 21	24	30	79	0.210
G3/4	20	4891 27 27	32	42	84	0.300
G1	25	4891 34 34	38	42	102	0.519

4892 Non-Return Valve, Supply, Female BSPP Thread/Exhaust, Male BSPP Thread



Stainless steel 316L, FKM

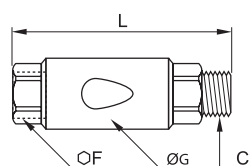

C	DN		F	G	L	Kg
G1/8	10	4892 10 10	17	22	56	0.100
G1/4	10	4892 13 13	17	22	58	0.082
G3/8	15	4892 17 17	22	30	75	0.192
G1/2	15	4892 21 21	24	30	79	0.211
G3/4	20	4892 27 27	32	42	84	0.300
G1	25	4892 34 34	38	42	102	0.519

4895 Non-Return Valve, Female NPT Thread



Stainless steel 316L, FKM

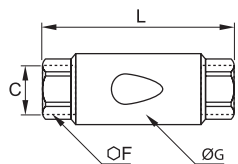

C	DN		F	G	L	Kg
NPT1/8	10	4895 11 11	17	22	50	0.083
NPT1/4	10	4895 14 14	17	22	54	0.079
NPT3/8	15	4895 18 18	22	30	67	0.197
NPT1/2	15	4895 22 22	24	30	77	0.196

Soft Start Fittings

These fittings protect your system by preventing sudden shocks. On start-up, they control the **pressure increase** in the downstream circuit; this helps **prevent the risk** of industrial accidents.

Product Advantages

Protection of Equipment & Personnel

Prevents the risk of damage after any stoppage which requires the system to be vented
Returns the control valve to its initial position in total safety
Adjustment of the pressurisation speed
Protects the adjustment mechanism using a recessed adjustment screw

Mounted on FRL

Models 7860 and 7861: yellow identification washer
Protection for the whole system
Simultaneous pressurisation speed of the whole system

Mounted on Control Valve

Models 7870 and 7871: black identification washer
Protection of individual circuits
Mounted on the control valve, it optimises the pressurisation speed of a specific cylinder



Pneumatic Systems
Robotics
Textile
Semi-Conductors
Packaging
Pneumatics

Applications

Technical Characteristics

Compatible Fluids	Compressed air
Working Pressure	3 to 10 bar
Working Temperature	-15°C to +60°C

Max. Tightening Torques	Threads	daN.m
	G1/4	1.3
G3/8	1.5	
G1/2	1.8	

Flow Characteristics	Model	Flow at 6 bar	Kv
	7860 08 13	1500 NI/min	0.80
7860 10 13	2100 NI/min	1.20	
7860 10 17	2200 NI/min	1.30	
7860 12 17	3100 NI/min	1.00	
7860 12 21	3100 NI/min	1.00	
7861 13 13	2100 NI/min	1.20	
7861 17 17	3100 NI/min	1.00	
7861 21 21	3100 NI/min	1.00	
7870 08 13	1500 NI/min	0.80	
7870 10 13	2000 NI/min	1.15	
7870 10 17	2000 NI/min	1.15	
7871 13 13	2000 NI/min	1.15	
7871 17 17	2000 NI/min	1.15	

Component Materials

Internal seal: NBR

Screw: nickel-plated brass

Washer: technical polymer

Body: technical polymer or nickel-plated brass



Silicone-free

Regulations

DI: 2002/95/CE (RoHS)
RG: 1907/2006 (REACH)
DI: 97/23/CE (PED)

Operation

Filter, Regulator, Lubricator

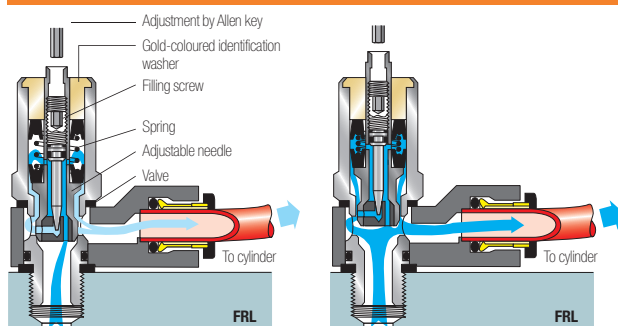

Control Valve

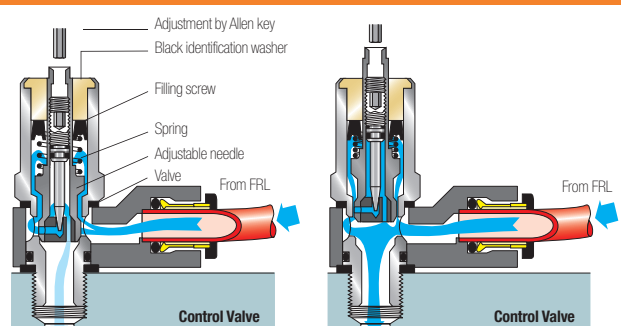

Soft Start Fittings

7860 Soft Start Fitting for Isolating Valve, Male BSPP Thread

Technical polymer, nickel-plated brass, NBR

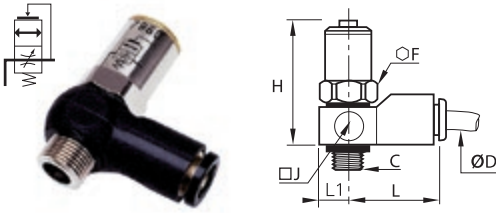

ØD	C		F	H _{min}	H _{max}	J	L	L1	Kg
8	G1/4	7860 08 13	17	54	61	20	35	10	0.064
10	G1/4	7860 10 13	22	55	62	25	41	12.5	0.112
	G3/8	7860 10 17	22	55	62	25	41	12.5	0.115
12	G3/8	7860 12 17	22	55	62	25	45	12.5	0.125
	G1/2	7860 12 21	22	63.5	70.5	25	45	12.5	0.152

7861 Soft Start Fitting for Isolating Valve, Male/Female BSPP Thread

Nickel-plated brass, NBR, technical polymer

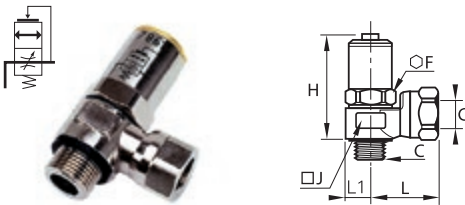

C		F	H _{min}	H _{max}	J	L	L1	Kg
G1/4	7861 13 13	22	54	62	24	31	12	0.147
G3/8	7861 17 17	22	55	62	24	31	12	0.139

7870 Soft Start Fitting for Control Valve, Male BSPP Thread

Technical polymer, nickel-plated brass, NBR

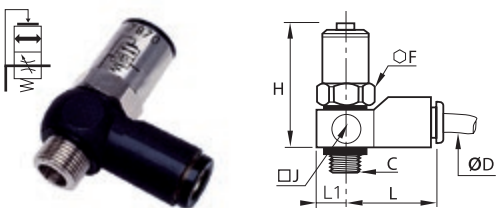

ØD	C		F	H _{min}	H _{max}	J	L	L1	Kg
8	G1/4	7870 08 13	17	54	61	20	35	10	0.066
10	G1/4	7870 10 13	22	55	62	25	41	12.5	0.113
	G3/8	7870 10 17	22	55	62	25	41	12.5	0.116

7871 Soft Start Fitting for Control Valve, Male/Female BSPP Thread

Nickel-plated brass, NBR, technical polymer

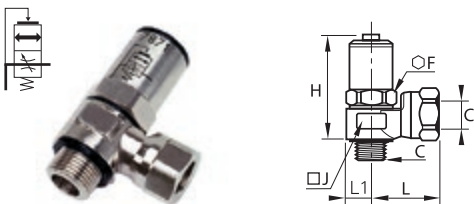

C		F	H _{min}	H _{max}	J	L	L1	Kg
G1/4	7871 13 13	22	55	62	24	31	12	0.149
G3/8	7871 17 17	22	55	62	24	31	12	0.141

Adjustment of the Filling Screw

Adjusting the screw to regulate the flow of air optimises the time taken to pressurise depending on the air volume to be refilled and the system requirements.

To adjust:

- immobilise the piston using a spanner
- adjust the screw with an Allen key
 - 1.5 mm key for 8 mm diameter
 - 2.5 mm key for 10 and 12 mm diameter

Max. tightening torque: 0.1 daN.m

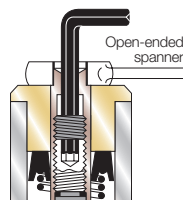

Cylinder Pressure Cycle

When the downstream pressure reaches 2/3 of the supply pressure, full flow is automatically established

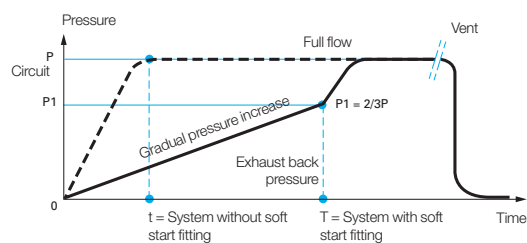

Pneumatic Sensor Fittings

The sensor detects the pressure drop when a cylinder reaches the end of its stroke. They produce a **pneumatic or electric output signal** when the pressure drop in the exhaust chamber of the cylinder goes below their back pressure threshold.

Product Advantages

Easy-to-Use

Suited to changes of series: no adjustment to position detectors is necessary

With Pneumatic Output

Totally pneumatic installation

2 possible installations:

- Supplied with permanent pressure (P1): produces a pneumatic signal when the back pressure threshold is reached
- Supplied from the control valve-cylinder circuit on the opposite side: no unexpected pneumatic signal (S) can appear during pressurisation due to the actuating pressure which supplies the sensor fitting (P1)

With Electrical Output

Combined electrical and pneumatic installation

Installation with continuous electrical supply only (BU)

Guarantees an electrical signal when the back pressure threshold is reached



Applications
Robotics
Textile
Semi-Conductors
Packaging
Pneumatics

Technical Characteristics

Compatible Fluids	Compressed air
Working Pressure	3 to 8 bar
Working Temperature	-15°C to +60°C
Back Pressure	0.85 to 1 bar
Switching Time	Model 7818: 3 ms
Open/Closed Contact	Model 7828: 2A / 0-48 V 2A / 250 V 50 Hz

Component Materials

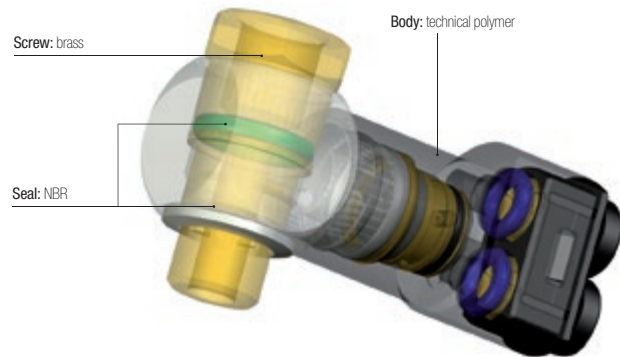

Silicone-free

Regulations

DI: 2002/95/EC (RoHS)
RG: 1907/2006 (REACH)
DI: 97/23/EC (PED)

Operation

Pneumatic Installation Diagram



P': Exhaust back pressure
P: Dynamic pressure
P1: Sensor supply pressure
S: Output signal

Electrical Installation Diagram

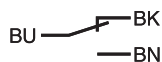

Connection via 3 core 0.5 mm² cable, 2 meters long.
Contactor: 5A / 250 V ~ or 5W / 48V ==

Cylinder in Operation

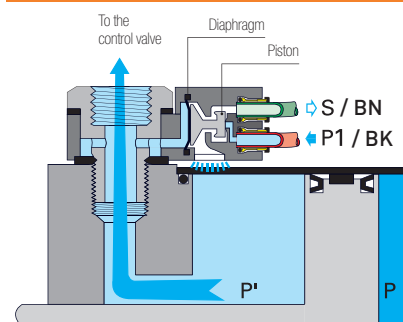

Cylinder in Final Position

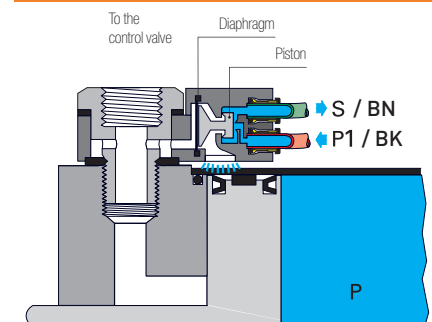

Pneumatic Sensor Fittings

7818 Pneumatic Sensor Fitting, Male BSPP and Metric Thread



Zamak, NBR, technical polymer, brass

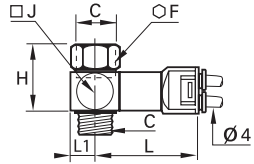

ØD	C	F	H	J	L	L1	Kg
M5x0.8	7818 04 19*	8	16	11	43.5	5.5	0.025
G1/8	7818 04 10	14	23	16	44.5	8	0.043
G1/4	7818 04 13	17	28	19.5	46.5	10	0.061
G3/8	7818 04 17	22	29	23.5	49	12	0.083
G1/2	7818 04 21	27	30	31.5	52.5	16	0.125

* Bolt zinc passivated steel

7818 Pneumatic Sensor, Male/Female BSPP Thread



Zamak, NBR, technical polymer, brass

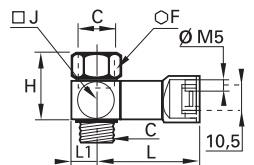

C	F	H	J	L	L1	Kg	
G1/8	7818 19 10	14	23	16	40.5	8	0.049
G1/4	7818 19 13	17	28	19.5	42.5	10	0.065

7828 Pneumatic/Electric Sensor, Male/Female BSPP and Metric Thread



Technical polymer, NBR, brass

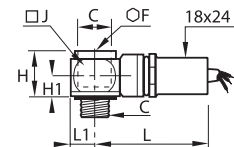

C	F	H	H1	J	L	L1	Kg
M5x0.8	7828 00 19	8	20	10	49	5.5	0.116
G1/8	7828 00 10	6	20	10	52	8	0.132
G1/4	7828 00 13	8	20	10	54	10.5	0.140
G3/8	7828 00 17	10	22	12	57	14	0.184
G1/2	7828 00 21	12	26	14	58	16.5	0.206

Cylinder Pressure Cycle

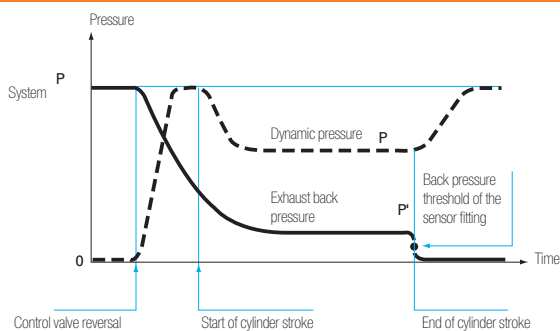

Installation Diagram

Depending on model, S1, S2 and P1 may be pneumatic or electric. See the installation diagrams opposite.

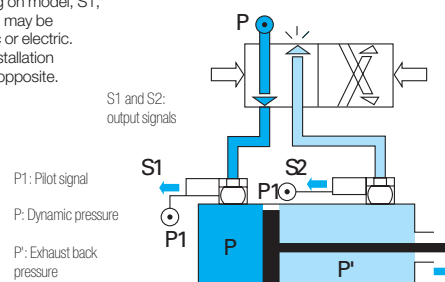

Pressure Regulators

Parker Legris pressure regulators **stabilise at the maximum determined value** the pressure delivered to the pneumatic equipment, whatever the fluctuations of the pressure upstream.

Product Advantages

Ergonomics Easy adjustment of the output pressure through the knurled screw
 Lockable adjustment possible
 Output pressure adjustment options marked on the screw

Energy Savings Setting of the optimum pressure enables the equipment to function correctly
 Installation in a manifold allows optimum output pressures to be delivered to specific parts of the circuit
 Designed for applications where cylinder force needs to be controlled: marking, sleeving, crimping cylinders etc.



Robotics
 Textile
 Semi-Conductors
 Packaging
 Pneumatics

Applications

Technical Characteristics

Compatible Fluids	Compressed air
Working Pressure	Upstream pressure: 1 to 16 bar Downstream pressure: 1 to 8 bar
Working Temperature	-10°C to +70°C

Max. Tightening Torques	Threads	G1/8	G1/4	G3/8
	daN.m	0.4	0.5	0.6

Component Materials



Silicone-free

Regulations

DI: 2002/95/EC (RoHS)
 RG: 1907/2006 (REACH)
 DI: 97/23/EC (PED)

Operation

Mounting Upstream of the Control Valve

Adjustment of the piston feed pressure in both directions

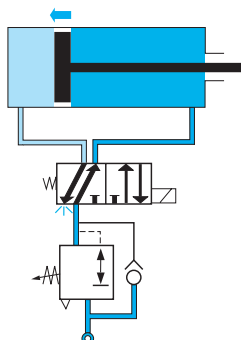

Mounting Downstream of the Control Valve

Phase 1: adjustment of the piston speed in a single direction

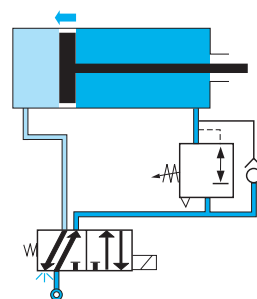

Phase 2: in return direction, pressure is supplied through the control valve

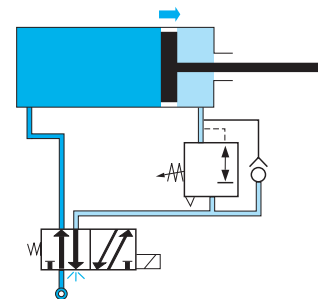

Pressure Regulators

7300 Pressure Regulator, Male BSPP Thread

Technical polymer, nickel-plated brass, NBR

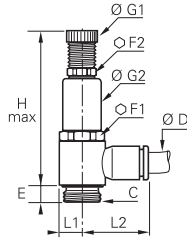

ØD	C		E	F1	F2	G1	G2	H _{max}	L1	L2	Kg
4	G1/8	7300 04 10	4.5	17	13	14	17	65	7	18.5	0.047
6	G1/8	7300 06 10	4.5	17	13	14	17	65	7	20	0.047
	G1/4	7300 06 13	7.5	17	13	14	17	74.5	9.5	22	0.065
8	G1/8	7300 08 10	4.5	17	13	14	17	65	7	25	0.048
	G1/4	7300 08 13	7.5	17	13	14	17	74.5	9.5	27	0.066
10	G3/8	7300 08 17	8.5	22	17	18.5	22	84	11.5	28.5	0.122
	G1/4	7300 10 13	7.5	17	13	14	17	74.5	9.5	29	0.067
	G3/8	7300 10 17	8.5	22	17	18.5	22	84	11.5	30.5	0.122

Flow Characteristics at 7 bar (Nl/min)

G1/8 Models

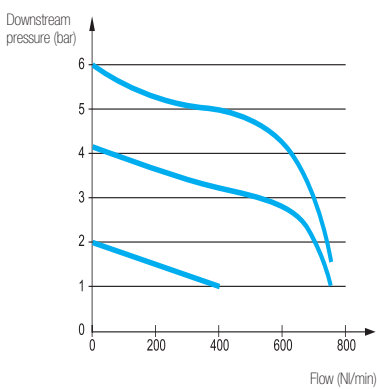

G1/4 Models

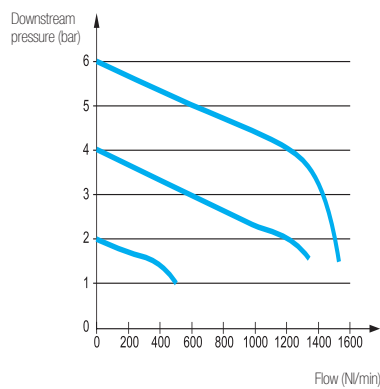

G3/8 Models

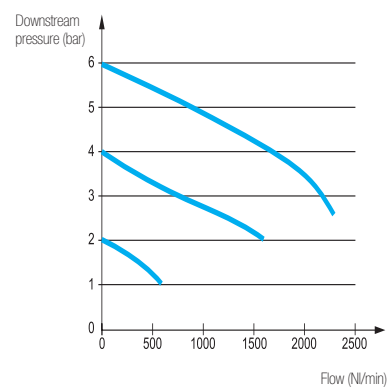

Pressure Reducers

Parker Legris pressure reducers are designed to **set the pressure** of a compressed air circuit to a determined value. They therefore enable **energy saving** by limiting the cylinder pressure.

Product Advantages

Design & Performance

- Optimisation of the pressure at the minimum values required to provide final force and energy consumption
- Manual adjustment protected by a plug
- Visual indication of the differential pressure by colour code

Two Models Available

- Banjo: fitted directly on the control valve or terminal block
- In-line: fitted in the pipework, between the control valve and cylinder



Applications

- Robotics
- Textile
- Semi-Conductors
- Packaging
- Pneumatics

Technical Characteristics

Compatible Fluids	Compressed air				
Working Pressure	1 to 8 bar				
Working Temperature	-15°C to +60°C				
Max. Tightening Torques for Models 7318 and 7471	Threads	G1/8	G1/4	G3/8	G1/2
	daN.m	0.8	1.2	3	3.5

Component Materials

Internal seals: NBR

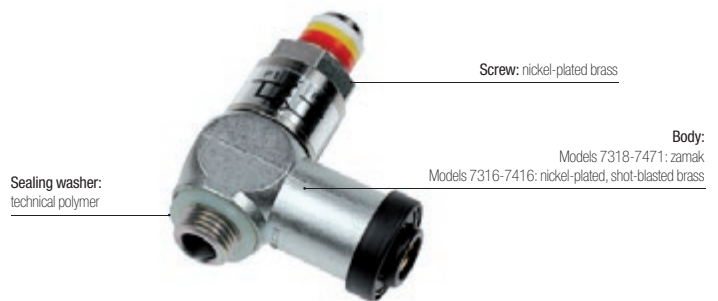

Silicone-free

Regulations

DI: 2002/95/EC (RoHS)
 RG: 1907/2006 (REACH)
 DI: 97/23/EC (PED)

Operation

Installation Diagram

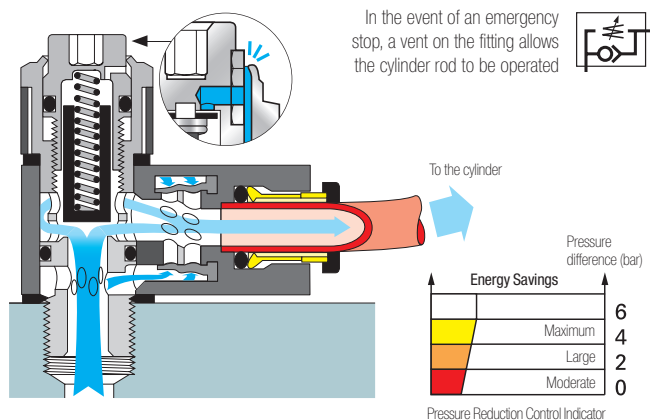

Cylinder Pressure Cycle

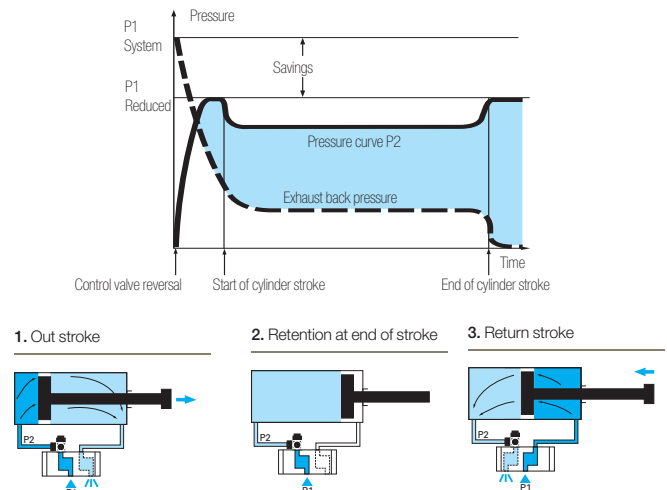

Manual Adjustment

To ease access to the adjustment, Parker Legris has designed a plug-in manual control system.

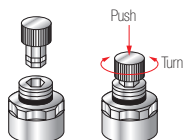

To prevent access to the setting mechanism, a sealing plug may be used.

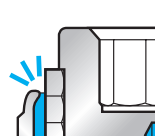

This may be removed if necessary as follows:

1. Pierce the centre
2. Remove the plug



Pressure Reducers

7318 Banjo Pressure Reducer, Male BSPP Thread



Zamak, NBR, technical polymer, nickel-plated brass

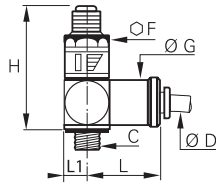

ØD	C		F	G	H _{min}	H _{max}	L	L1	Kg
6	G1/8	7318 06 10	19	20	49	57	43	10.5	0.137
	G1/4	7318 06 13	19	20	49	57	43	10.5	0.135
8	G1/4	7318 08 13	19	20	49	57	40	10.5	0.134
	G1/4	7318 10 13	27	20	55	64	50	14	0.250
10	G3/8	7318 10 17	27	26	55	94	50	14	0.253

7471 Banjo Pressure Reducer, Male/Female BSPP Thread



Zamak, NBR, technical polymer, nickel-plated brass

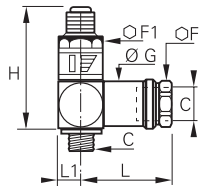

C		F	F1	G	H _{min}	H _{max}	L	L1	Kg
G1/8	7471 10 10	19	19	20	49	57	45	10.5	0.160
G1/4	7471 13 13	19	19	20	49	57	45	10.5	0.149
G3/8	7471 17 17	24	27	26	55	64	56	14	0.288
G1/2	7471 21 21	30	30	31	75	86	63	16.5	0.502

7316 In-Line Tube-to-Tube Pressure Reducer



Nickel-plated brass, NBR, technical polymer

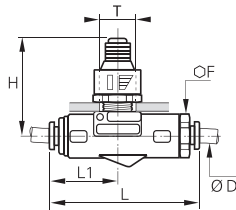

ØD		F	H _{min}	H _{max}	L	L1	ØT	Kg
6	7316 06 00	22	49	57	74	32	18.5	0.214
8	7316 08 00	22	49	57	71	32	18.5	0.199
10	7316 10 00	27	61	70	89	41	22.5	0.411

7416 In-Line Pressure Reducer, Female BSPP Thread



Nickel-plated brass, NBR

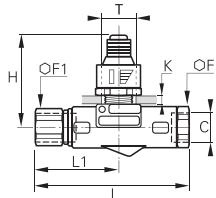

C		F	F1	H _{min}	H _{max}	K	L	L1	ØT	Kg
G1/8	7416 10 10	17	19	49	57	4	74	35	18.5	0.213
G1/4	7416 13 13	17	19	49	57	4	83	44	18.5	0.214
G3/8	7416 17 17	22	27	61	70	5	90	44	22.5	0.399
G1/2	7416 21 21	27	30	75	86	7	119	61	22.5	0.651

7000 Sealing Plug for Pressure Reducer

Technical polymer



		G	Kg
7000 00 01		8	0.001

7000 Manual Ratchet Control for Pressure Reducer

Nickel-plated brass, NBR

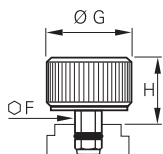

		F	G	H	Kg
7000 00 00		6	22	15	0.040

Snap Fittings

The snap fittings enable a **circuit to be isolated** without the need to vent the complete system. They are designed to facilitate repeated connections and disconnections in total safety.



Product Advantages

- Performance & Safety**
- Partial venting of systems while work is carried out
 - Energy and time-saving during maintenance operations
 - Protection of individuals by maintaining pressure if necessary
 - Audible click indicates connection
 - Circuit identification by coloured rings (on request)

- Applications**
- Control Panels
 - Robotics
 - Semi-Conductors
 - Packaging
 - Pneumatics
 - Automotive Process

Technical Characteristics

Compatible Fluids	Compressed air
Working Pressure	0 to 10 bar
Working Temperature	-20°C to +80°C
Flow Characteristics at 6 bar	DN 5 mm: 1000 NI/min DN 7 mm: 1900 NI/min

Regulations

DI: 2002/95/EC (RoHS)
RG: 1907/2006 (REACH)
DI: 97/23/EC (PED)

Component Materials

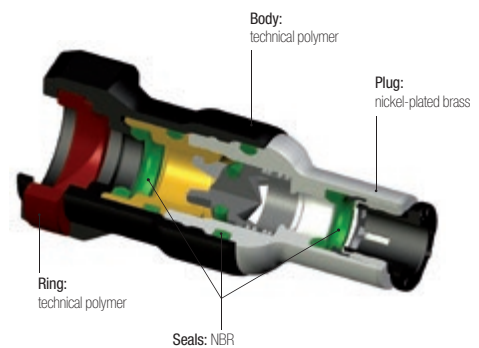

Silicone-free

Operation

Circuit Closed

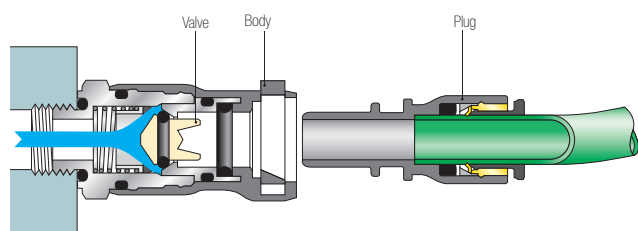

Circuit Open

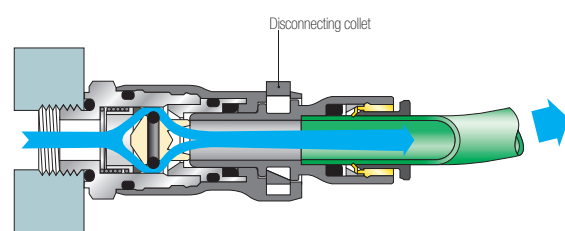

Flow Characteristics - Pressure Drop

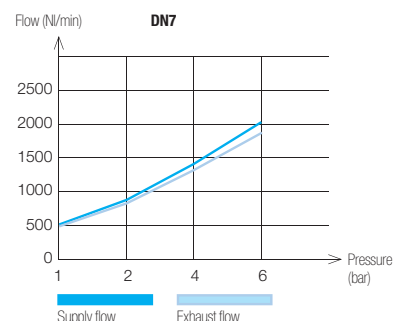
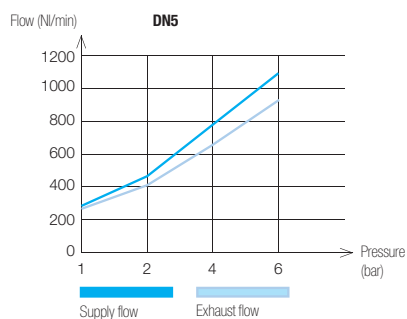

Snap Fittings

7926 Body with Push-In Connection



Technical polymer, nickel-plated brass, NBR

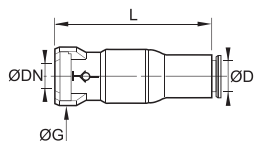

ØD	DN		G	L	Kg
6	5	7926 05 06	18.5	44	0.020
8	5	7926 05 08	18.5	49	0.024
10	7.3	7926 07 10	22	58.5	0.044

7921 Body with Male BSPP Thread



Technical polymer, nickel-plated brass, NBR

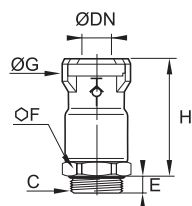

C	DN		E	F	G	H	Kg
G1/8	5	7921 05 10	5.5	16	18.5	31.5	0.022
G1/4	5	7921 05 13	5.5	16	18.5	31.5	0.023
	7.3	7921 07 13	5.5	20	22	37.5	0.039
G3/8	7.3	7921 07 17	5.5	20	22	37.5	0.041

7960 Straight Probe, Push-In Connection



Technical polymer, NBR

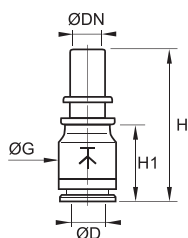

ØD	DN		G	H	H1	Kg
6	5	7960 05 06	13.5	36.5	17.5	0.007
8	5	7960 05 08	13.5	37	18	0.003
10	7.3	7960 07 10	16	41	20.5	0.004

7961 Straight Probe, Male BSPP Thread



Technical polymer, nickel-plated brass, NBR

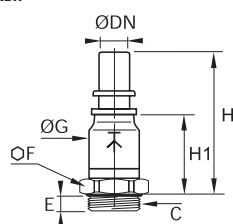

C	DN		E	F	G	H	H1	Kg
G1/8	5	7961 05 10	5.5	13	13.5	46	27	0.017
G1/4	5	7961 05 13	5.5	16	13.5	46	27	0.019
	7.3	7961 07 13	5.5	16	16	51.5	31	0.026
G3/8	7.3	7961 07 17	5.5	20	16	51.5	31	0.034

Manually-Operated Valves

Manually-operated valves offer a **reliable** and **durable** system for opening and closing the circuit when the system has to be **switched frequently**. They provide a significant reduction in the time needed to work on pneumatic circuits.

Product Advantages

Manual Switch-Operated Valves

Downstream control supply provided by simply moving the lever
 2 models available to provide the best solution for the system:

- 3/2: opening, closing, venting
- 2/2: opening, closing

Compact and ergonomic (can be positioned through 360°)
 Push-in connections

Valves with Sliding Sleeve

Uni-directional use ensures the downstream circuit is vented
 Operated in the plane of the tube
 Lightweight due to the use of aluminium
 Ideal for complex installations in a restricted space
 Immediate identification of the venting system by the colour (red)



Applications

Robotics
 Conveyors
 Textile
 Plastics Engineering
 Printing
 Pneumatics
 Packaging

Technical Characteristics

Compatible Fluids	Compressed air
Working Pressure	0 to 10 bar Model 0669: 0 to 16 bar
Working Temperature	-10°C to +80°C Model 0669: -5°C to +70°C

Component Materials

Seals: NBR

Bolt:
 Manual switch-operated valve: nickel-plated brass with seal
 Sleeve valve: nickel-plated brass

Body:
 Manual switch-operated valve: technical polymer
 Sleeve valve: nickel-plated brass

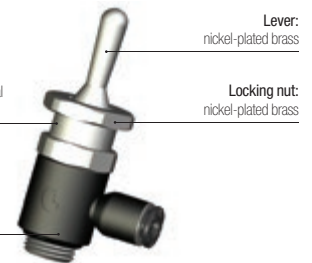

Silicone-free

Regulations

DI: 2002/95/EC (RoHS)
 RG: 1907/2006 (REACH)
 DI: 97/23/EC (PED)

Operation

Switch-Operated Valves



Open

Closed

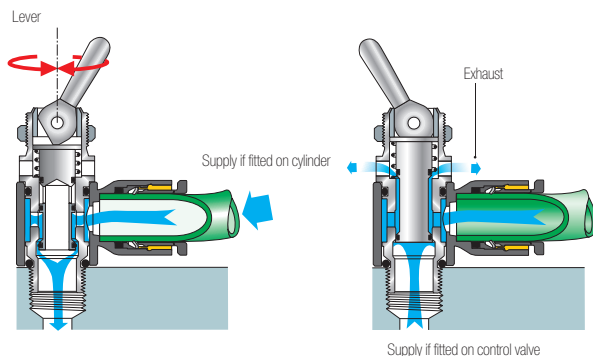

Sleeve Valves

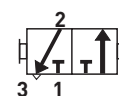

Open: downstream supply

Closed: downstream exhaust

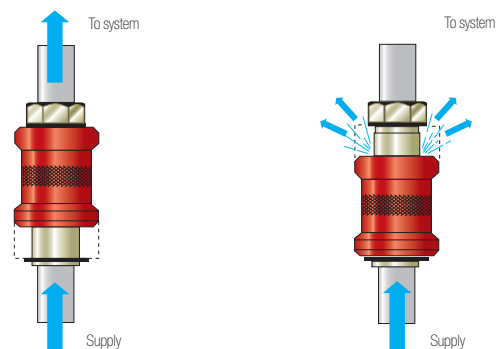

Manually-Operated Valves

7800

3/2 Manual Switch-Operated Valve, Supply, Male BSPP and Metric Thread



Technical polymer, nickel-plated brass, NBR

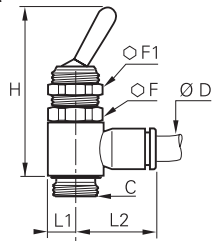

ØD	C		F	F1	H	L1	L2	Kg
4	M5x0.8	7800 04 19	14	14	55	7	18.5	0.032
	G1/8	7800 04 10	14	14	43	7	18.5	0.022
6	M5x0.8	7800 06 19	14	14	55	7	18.5	0.032
	G1/8	7800 06 10	14	14	43	7	20	0.023
8	G1/8	7800 08 10	14	14	43	7	25	0.023
	G1/4	7800 08 13	17	14	50.5	9	27	0.048
10	G1/8	7800 10 13	17	14	50.5	9	29	0.048
	G1/4	7800 10 13	17	14	50.5	9	29	0.048

For part numbers 7800 04 19 and 7800 06 19, adaptor sealing is effected by a flat PTFE seal and tightening torque is maximum 0.16 daN.m.

7801

3/2 Manual Switch-Operated Valve, Control, Male BSPP Thread



Technical polymer, nickel-plated brass, NBR

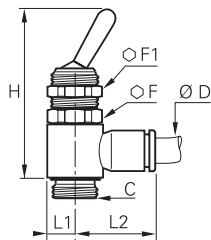

ØD	C		F	F1	H	L1	L2	Kg
4	G1/8	7801 04 10	14	14	43	7	18.5	0.023
6	G1/8	7801 06 10	14	14	43	7	20	0.023
	G1/4	7801 06 13	17	14	50.5	9	22	0.048
8	G1/8	7801 08 10	14	14	43	7	25	0.026
	G1/4	7801 08 13	17	14	50.5	9	27	0.049
10	G1/4	7801 10 13	17	14	50.5	9	29	0.051

7802

2/2 Manual Switch-Operated Valve, Male BSPP Thread



Technical polymer, nickel-plated brass, NBR

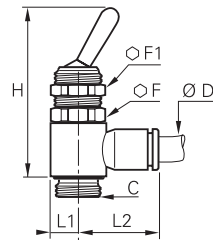

ØD	C		F	F1	H	L1	L2	Kg
4	G1/8	7802 04 10	14	14	43	7	18.5	0.023
	G1/8	7802 06 10	14	14	43	7	20	0.023
6	G1/4	7802 06 13	17	14	50.5	9	22	0.051
	G1/8	7802 08 10	14	14	43	7	25	0.024
8	G1/4	7802 08 13	17	14	50.5	9	27	0.052
	G1/4	7802 10 13	17	14	50.5	9	29	0.052

0669

3/2 Sleeve Valve, Female BSPP and Metric Thread



Nickel-plated brass, NBR

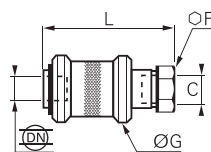

C	DN		F	G	L	Kg
M5x0.8	2.5	0669 02 19	10	14	30.5	0.012
G1/8	4	0669 04 10	14	25	48	0.050
G1/4	7	0669 07 13	19	30	58	0.095
G3/8	10	0669 10 17	22	35	68	0.154
G1/2	14	0669 14 21	27	40	75	0.209
G3/4	19	0669 19 27	32	50	83	0.323

Metal Quick Exhaust Valves

This range of metal quick exhaust valves is offered in nickel-plated brass, aluminium and stainless steel. These valves, which are suitable for **any environment**, increase the **return speed** of the cylinder rod by allowing the exhaust to pass directly to atmosphere.

Product Advantages

Time-Saving & Compact

Reduction in cycle times: return speed improved
 Dimensions optimised for space reduction
 Exhaust silencer incorporated on some models
 Excellent exhaust capacity
 Robust

Nickel-Plated Brass or Stainless Steel

Ideal for applications in restrictive environments
 Orientation as required
 Many installation options and choice of silencer
 Designed without retention areas to optimise frequent cleaning operations (stainless steel)

Aluminium

Protection of individuals through low noise emissions
 Lightweight and robust
 Silencer integrated for greater compactness



Applications
 Robotics
 Conveyors
 Textile
 Plastics Engineering
 Printing
 Pneumatics
 Packaging

Technical Characteristics

Compatible Fluids	Compressed air
Working Pressure	7970: 0.7 to 10 bar 7971 and 7899: 2 to 10 bar
Working Temperature	7970: -20°C to +70°C 7971: -10°C to +70°C 7899: Threads G1/8 and G1/4: -10°C to +120°C Threads G3/8 to G1: -20°C to +180°C

Component Materials

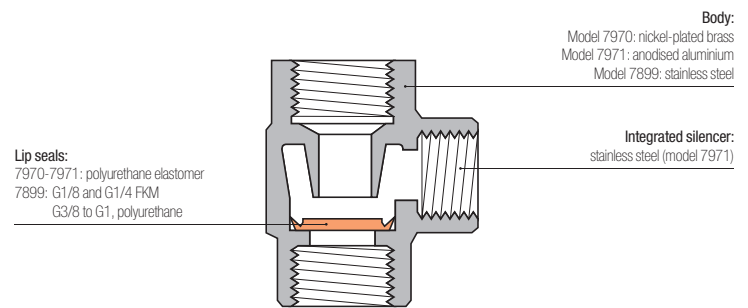

Silicone-free

Regulations

DI: 2002/95/EC (RoHS)
 RG: 1907/2006 (REACH)
 DI: 97/23/EC (PED)

Operation

Mounted on Cylinder

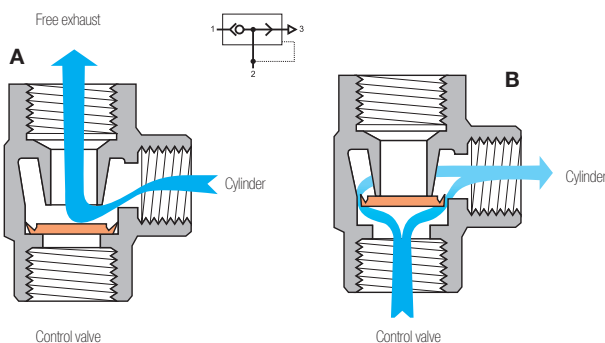

Installation Diagram

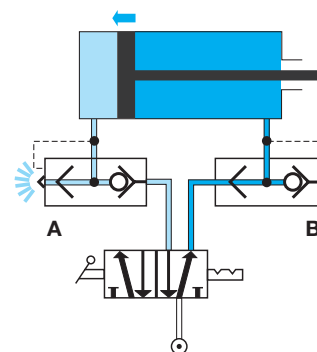

Metal Quick Exhaust Valves

7970

Elbow Quick Exhaust Valve, Female BSPP and Metric Thread



Nickel-plated brass

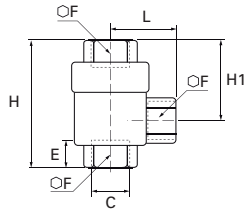

C		E	F	H	H1	L	Kg
M5x0.8	7970 19 19	5	10	24.8	15.6	4	0.029
G1/8	7970 10 10	7.5	14	42	28	8	0.084
G1/4	7970 13 13	11	19	53	34.5	11	0.148
G3/8	7970 17 17	12	21	58	36	12	0.153
G1/2	7970 21 21	14	26	71	44	14	0.316
G3/4	7970 27 27	16	32	86	52	18	0.449
G1	7970 34 34	19	38	94	56	19	0.531

Noise level:

7971 10 10: 70 dBa

7971 13 13: 70 dBa

7971 17 17: 72 dBa

7971 21 21: 88 dBa

7971

Elbow Quick Exhaust Valve, Male BSPT/Female BSPP Thread



Treated aluminium

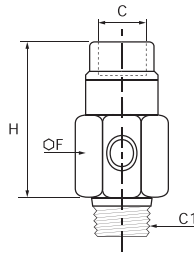

C	C1		F	H	Kg
G1/8	R1/8	7971 10 10	18	51	0.013
G1/4	R1/4	7971 13 13	18	49	0.018
G3/8	R3/8	7971 17 17	27	56	0.048
G1/2	R1/2	7971 21 21	34	70	0.086

7899

Quick Exhaust Valve, Female BSPP Thread



Stainless steel 316L

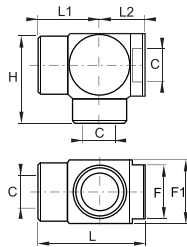

C	DN		F	F1	H	L	L1	L2	Kg
G1/8	7	7899 00 10	17	22	31.5	37.5	21	16.5	0.097
G1/4	7	7899 00 13	17	22	31.5	37.5	21	16.5	0.084
G3/8	9	7899 00 17	22	26	37	44.5	25.5	19	0.140
G1/2	12	7899 00 21	27	32	45	54	31	23	0.236
G3/4	18	7899 00 27	38	46	65	79	44	35	0.801
G1	18	7899 00 34	38	46	65	79	44	35	0.674

To complement our exhaust valves 7970 and 7899, you will find a full range of silencers on the following pages.

Silencers

Silencers are designed for installation on exhaust circuits **to reduce the noise levels** of equipment while operating, thus improving user comfort.

Product Advantages

- Variety of Applications**
- 2 versions incorporating flow control regulation
 - Extremely compact models available
 - Polyethylene: excellent balance between exhaust flow rate and noise reduction
 - Sintered bronze: robust and economic
 - 316L stainless steel: increased chemical resistance and mechanical strength



Robotics
Textile
Semi-Conductors
Packaging
Pneumatics

Applications

Technical Characteristics

Compatible Fluids	Compressed air
Working Pressure	Polyethylene: 0 to 10 bar Sintered bronze: 0 to 12 bar 316L stainless steel: 0 to 12 bar
Working Temperature	Polyethylene: -10°C to +80°C Sintered bronze: -20°C to +150°C 316L stainless steel: -20°C to +180°C

Component Materials

Body:
brass (0670-0673-0675-0671-0677-0672)
polymer (0674-0676)
stainless steel (0682-0683)

Silencer:
sintered bronze (0670-0673-0675-0671-0677-0672)
polymer (0674-0676)
316L stainless steel (0682-0683)

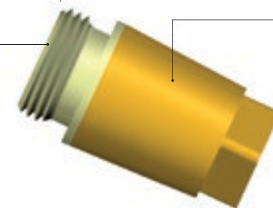

Silicone-free

Regulations

DI: 2002/95/EC (RoHS)
RG: 1907/2006 (REACH)
DI: 97/23/EC (PED)
DI: 2003/10/EC (Noise Directive)
Requirement to use ear protection if exposure > 8 hours (85 dBA)
RG: 1910.95(b) (OSHA)
Requirement to use ear protection if exposure > 8 hours (90 dBA)

Flow and Noise Levels for Silencers 0672 and 0676

0672	Number of Turns						Noise Level in dBA at 6 bar and 350 NI/min
	0	1	2	3	4	5	
0672 00 10	0	200	600	740	-	-	81
0672 00 13	0	300	650	1280	-	-	82
0672 00 17	0	450	950	1300	1500	-	83
0672 00 21	0	830	1430	1800	2100	2220	83

0676	Number of Turns										Noise Level in dBA at 6 bar and 350 NI/min
	0	1	2	3	4	5	6	7	8	9	
0676 00 10	0	30	90	210	335	370	390	390	395	395	82
0676 00 13	0	22	25	50	340	750	940	980	1000	1025	84
0676 00 19	0	22	69	97	125	143	-	-	-	-	81
0676 00 17	0	518	1147	1716	2153	2571	2823	2930	-	-	85
0676 00 21		814	1849	2880	4087	5044	5236	-	-	-	86

Silencers

0674 Polymer Silencer, Male BSPP and Metric Thread

Technical polymer

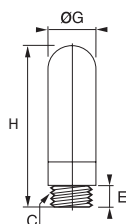

C		E	G	H	Kg
M5x0.8	0674 00 19	4	6.5	23	0.003
G1/8	0674 00 10	6	12.5	34	0.002
G1/4	0674 00 13	7	15.5	42.5	0.003
G3/8	0674 00 17	11.5	18.5	67.5	0.007
G1/2	0674 00 21	11	23.5	78	0.010
G3/4	0674 00 27	15.5	38.5	131	0.035
G1	0674 00 34	19.5	49	160	0.056

0676 Flow Control Polymer Silencer, Male BSPP and Metric Thread

Technical polymer

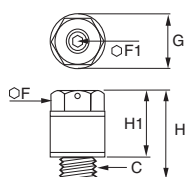

C		F	F1	G	H	H1	Kg
M5x0.8	0676 00 19	8	1.5	9.2	16	11	0.008
G1/8	0676 00 10	13	2.5	15	20.5	14.5	0.003
G1/4	0676 00 13	15	4	18	29	22	0.006
G3/8	0676 00 17	20	6	24	38	30	0.018
G1/2	0676 00 21	25	8	30	50	40	0.045

0670 Threaded Silencer, Male BSPP Thread

Sintered bronze, brass

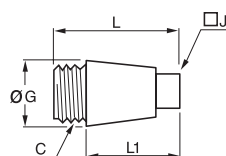

C		G	J	L	L1	Kg
G1/8	0670 00 10	12	7	22	17	0.007
G1/4	0670 00 13	15	9	27	21	0.015
G3/8	0670 00 17	19	11	35	28	0.028
G1/2	0670 00 21	23	13	43	34	0.049
G3/4	0670 00 27	30	17	55	53.5	0.087
G1	0670 00 34	37	21	65	53	0.148

0673 Compact Silencer, Male BSPP and Metric Thread

Sintered bronze, brass

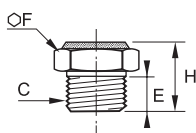

C		E	F	H	Kg
M5x0.8	0673 00 19	4	7	8	0.001
G1/8	0673 00 10	8	14	14	0.008
G1/4	0673 00 13	8	17	14	0.012
G3/8	0673 00 17	10	22	18	0.023
G1/2	0673 00 21	12	27	21	0.041

0675 Threaded Silencer, Male BSPP and Metric Thread

Sintered bronze, brass

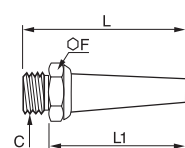

C		F	L	L1	Kg
M5x0.8	0675 00 19	7	16	12	0.002
M7x1	0675 00 55	11	25	19	0.005
G1/8	0675 00 10	14	42	34	0.014
G1/4	0675 00 13	17	52	44	0.023
G3/8	0675 00 17	22	54	44	0.038
G1/2	0675 00 21	27	65	53	0.073

Silencers

0671 Push-In Silencer

Nickel-plated brass, sintered bronze

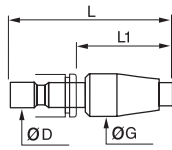

ØD		G	L	L1	Kg
4	0671 04 00	13	43.5	28.5	0.015
6	0671 06 00	15	50	33.5	0.024
8	0671 08 00	15	51	34	0.025
10	0671 10 00	19.5	67	45.5	0.052
12	0671 12 00	20	68	45	0.052

0677 Miniature Silencer, Male BSPP Thread

Sintered bronze, brass

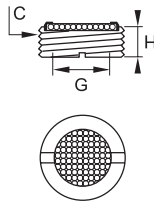

C		G	H	Kg
G1/8	0677 00 10	6	6	0.002
G1/4	0677 00 13	8	6	0.003
G3/8	0677 00 17	11	7	0.005
G1/2	0677 00 21	14	8	0.010
G3/4	0677 00 27	19	11	0.018
G1	0677 00 34	25	10	0.026

0672 Flow Control Silencer, Male BSPP Thread

Sintered bronze, nickel-plated brass

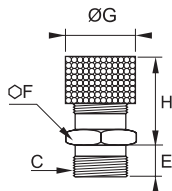

C		E	F	G	H min	H max	Kg
G1/8	0672 00 10	8	14	14	17	21	0.017
G1/4	0672 00 13	8	17	17	20	24	0.029
G3/8	0672 00 17	10	22	22	20	28	0.056
G1/2	0672 00 21	12	27	27	28	37	0.094

0682 Compact Silencer, Male BSPP Thread

Stainless steel 316L

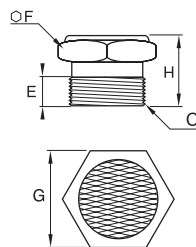

C		E	F	G	H	Kg
G1/8	0682 00 10	8	7	14	15	0.007
G1/4	0682 00 13	8	7	17	15	0.011
G3/8	0682 00 17	10	8	22	18	0.019
G1/2	0682 00 21	12	10	27	22	0.038
G3/4	0682 00 27	15	12	32	27	0.063
G1	0682 00 34	18	14	38	32	0.117

0683 Compact Silencer, Male NPT Thread

Stainless steel 316L

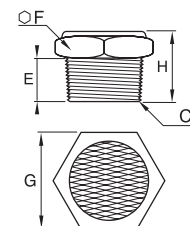

C		E	F	G	H	Kg
NPT1/8	0683 00 11	7	7	14	14	0.008
NPT1/4	0683 00 14	11	7	17	18	0.014
NPT3/8	0683 00 18	11	8	22	19	0.021
NPT1/2	0683 00 22	15	10	27	25	0.042



Compression Fittings

Brass Compression Fittings

Stainless Steel Compression Fittings

PL Nickel-Plated Brass Spigot Fittings



Compression Fittings

Brass Compression Fittings

(P. 5-5)



Fluids: compressed air, non-corrosive industrial fluids

Materials: forged or machined brass

Pressure: 550 bar

Temperature: -60°C to +250°C

Ø metric: 4 mm to 28 mm

Stainless Steel Compression Fittings

(P. 5-31)



Fluids: compressed air, coolants, industrial and corrosive fluids

Materials: 316L stainless steel

Pressure: 400 bar

Temperature: -60°C to +250°C

Ø metric: 6 mm to 16 mm

PL Nickel-Plated Brass Spigot Fittings

(P. 5-41)



Fluids: compressed air, compatible industrial fluids

Materials: forged or machined nickel-plated brass

Pressure: 18 bar

Temperature: -40°C to +100°C

Ø metric: 4 mm to 14 mm

Compression Fitting Part Numbers

0105 14 27 99

Item Type

01XX: brass
18XX: stainless steel

Ø

04 = 4 mm
06 = 6 mm
...
20 = 20 mm
28 = 28 mm

Thread

10 = 1/8
13 = 1/4
...
21 = 1/2
27 = 3/4

Suffix

39: bonded seal
40: treated steel
60: nut
70: polymer nut
99: chemical nickel

PL Fitting Part Numbers

F3BPL 8/10 -1/4

Item Type

FBPL
F3BPL
HBPL
WBPL
...

Ø

2.7/4
4/6
6/8
7.5/10
8/10
10/12
11/14

Thread

BSPT:
1/8
1/4
3/8
...
Metric:
M10
M12

NPT: with adaptor
BSPT and NPT

Related Products

Parker also offers another type of brass compression fitting:

Metrulok, with a one-piece olive/nut.

Do not hesitate to contact us.



Brass Compression Fitting Range

Brass Fittings

Stud Fittings

- | | | | | | | | |
|---------------------------------|--------------------------------|---|--------------------------------------|------------------------------------|----------------------------------|----------------------------------|---------------------------------|
| 0105
BSPT
Page 5-9 | 0105
NPT
Page 5-9 | 0101
BSPP/Metric
Page 5-10 | 0101..39
BSPP
Page 5-10 | 0101
Metric
Page 5-11 | 0114
BSPP
Page 5-11 | 0109
BSPT
Page 5-12 | 0109
NPT
Page 5-12 |
|---------------------------------|--------------------------------|---|--------------------------------------|------------------------------------|----------------------------------|----------------------------------|---------------------------------|



- | | | | | | | |
|----------------------------------|----------------------------------|----------------------------------|----------------------------------|--------------------------------------|----------------------------------|--------------------------------------|
| 0199
BSPP
Page 5-12 | 0108
BSPT
Page 5-13 | 0103
BSPT
Page 5-13 | 0118
BSPP
Page 5-14 | 0118..39
BSPP
Page 5-14 | 0119
BSPP
Page 5-15 | 0119..39
BSPP
Page 5-15 |
|----------------------------------|----------------------------------|----------------------------------|----------------------------------|--------------------------------------|----------------------------------|--------------------------------------|



Tube-to-Tube Fittings

- | | | | | | | |
|--------------------------|--------------------------|--------------------------|--------------------------|--------------------------|--------------------------|--------------------------|
| 0106
Page 5-15 | 0113
Page 5-16 | 0116
Page 5-16 | 0102
Page 5-16 | 0104
Page 5-17 | 0142
Page 5-17 | 0107
Page 5-17 |
|--------------------------|--------------------------|--------------------------|--------------------------|--------------------------|--------------------------|--------------------------|



Complementary Fittings

- | | | | | | | | |
|--------------------------|--------------------------|------------------------------|--------------------------|--------------------------|------------------------------|------------------------------|------------------------------|
| 0166
Page 5-20 | 0124
Page 5-21 | 0124..40
Page 5-21 | 0111
Page 5-21 | 0110
Page 5-22 | 0110..40
Page 5-22 | 0110..60
Page 5-22 | 0110..70
Page 5-22 |
|--------------------------|--------------------------|------------------------------|--------------------------|--------------------------|------------------------------|------------------------------|------------------------------|



Self-Fastening Hose Barb Connectors

- | | | |
|--------------------------|------------------------------|--------------------------|
| 0132
Page 5-25 | 0133..39
Page 5-25 | 0134
Page 5-25 |
|--------------------------|------------------------------|--------------------------|



Accessories

- | | | | | | | | | | | |
|--------------------------|--------------------------|--------------------------|--------------------------|--------------------------|------------------------------|--------------------------|--------------------------|------------------------------|------------------------------|------------------------------|
| 0122
Page 5-26 | 0165
Page 5-26 | 0126
Page 5-27 | 0125
Page 5-27 | 0220
Page 5-27 | 0220..39
Page 5-27 | 0120
Page 5-28 | 0112
Page 5-28 | 0128..39
Page 5-29 | 0151..39
Page 5-29 | 0168..39
Page 5-29 |
|--------------------------|--------------------------|--------------------------|--------------------------|--------------------------|------------------------------|--------------------------|--------------------------|------------------------------|------------------------------|------------------------------|



- | |
|--------------------------|
| 0127
Page 5-30 |
|--------------------------|



Brass Compression Fittings

These **"universal"** fittings provide users with **numerous connection** options for a wide variety of tube materials without the need for tube threading or soldering. This range **guarantees** excellent long-term sealing and performance.

Product Advantages

Simple to Install and Use

- Suitable for pneumatic and medium pressure hydraulic applications
- Compatible with many industrial fluids
- Large product range: 22 configurations
- Excellent sealing due to the tightening of the olive onto the tube
- Metallic sealing guarantees maximum service life
- High strength brass for increased mechanical reliability

Wide Variety of Tubing

- Connection of different types of tubing and hose: metal, polymer, steel, rubber, etc.
- Multiple tube diameters can be connected using the Parker Legris reducer assembly system
- No insert required for rigid and semi-rigid polyamide tubing below 14 mm



- Applications**
- Pneumatics
 - Cooling
 - Automotive Process
 - Lubrication
 - Fluid Transmission
 - Packaging
 - Industrial Machinery

Technical Characteristics

Compatible Fluids	Water, machining oil, fuel, hydraulic oil, compressed air, chemical fluids, disinfectants
Working Pressure	Vacuum to 550 bar
Working Temperature	-60°C to +250°C without sealing washer, with metal tubing
Tightening Torque	See "Technical Characteristics" on opposite page

Working temperature: -20°C to +100°C, with sealing washer and polyamide tubing. Reliable performance is dependent upon the type of fluid conveyed, component materials and tubing being used. Guaranteed for use with a vacuum of 755 mm Hg (99% vacuum). Thread sealing must be guaranteed by user.

Component Materials

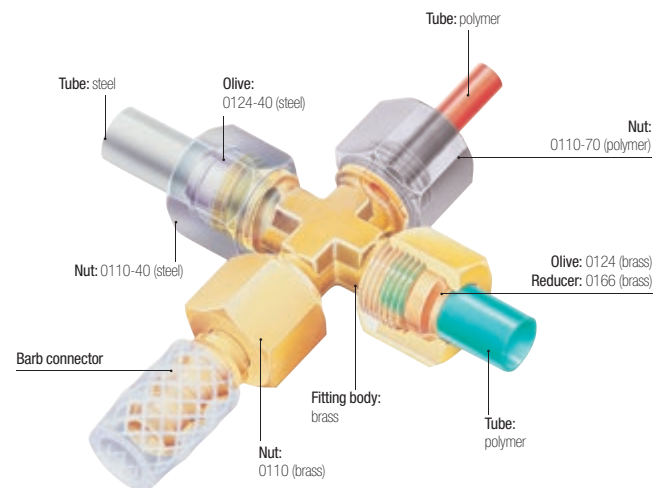

Maximum Bore Diameters

The table below shows the recommended compatibility of tube size, BSPP male thread and maximum bore.

Tube O.D.	BSPP Thread	Max. Bore
4-5-6	G1/8	4
6-8-10	G1/4	7
10-12-14	G3/8	11
14-15-16-18	G1/2	14
18-20-22	G3/4	18
22-25-28	G1	24

Tube Length for Assembly

Minimum length of tube (L) between 2 fittings.



ØD	L (mm)	ØD	L (mm)	ØD	L (mm)
4	26.5	12	39	20	51
5	26	14	41	22	54
6	26	15	41	25	62
8	32	16	46.5	28	62
10	39	18	49.5		

Regulations

- CNOMO:** E07.21.115N (for robotic equipment in the automotive industry)
- DI:** 97/23/EC (PED)
- RG:** 1907/2006 (REACH)
- DI:** 2002/95/EC (RoHS)
- DI:** 94/9/EC (ATEX)

Technical Characteristics

Installing Compression Fittings

Cutting the Tube



Cut the polymer or metal tube square.

Preparing the Connection



For metal tubing, de-burr the tube prior to connection. Tube bending should be done before connection.



Slide the nut onto the tube; lubricate the threads on the body and nut along with the olive to facilitate tightening (for metal tubing as well). Fit the olive onto the end of the tube.

Connecting the Tube



Push the tube up against the shoulder of the body of the fitting and hand tighten.

Final Assembly



Tighten the nut using a spanner or torque wrench to enable the olive to bite on the tube, the connection being completed when the recommended tightening torque is reached (see tables below).



It is recommended to use an insert in order to prevent tube creeping (diameter > 14mm)

Recommended Nut Tightening Torque

Tightening torque in daN.m = maximum tightening torque of a 0110 nut and 0124 olive with copper, brass or steel tube.

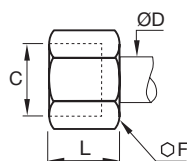

Nut 0110 and 0110..40

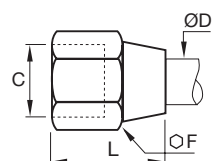

Nut 0110..60

Ø D (mm)	Ø F 0110	Ø F 0110..60	Max. daN.m Copper or Brass	Ø F 0110..40	Max. daN.m Steel
4	10	11	0.7	10	1.5
5	12	13	0.7	12	1.5
6	13	13	1.5	13	2.5
8	14	16	1.5	14	2.5
10	19	20	1.8	19	3
12	22	22	3	22	4.5
14	24	24	3.5	24	5.5
15	24	24	4	24	6
16	27	27	5	27	7
18	30	30	6	30	9
20	32	32	6	32	10
22	36	36	7	36	12
25	41	41	8	41	13
28	42		9		

Customised Fittings

Working directly with its customers and based on its knowledge and experience, Parker Legris can design customised brass compression fittings for specific requirements using the customer's specifications.

The range of compression fittings also offers nickel chemical surface treatment in order to improve the corrosion resistance and chemical compatibility of the fittings (the model number of the fitting is then given the suffix 99).

The above recommendations are given in good faith. However, since each application is different, it is advisable to undertake tests in actual working conditions.



Technical Characteristics

The use of Parker Legris brass compression fittings is dependant on the tube material. Tables of recommended working pressure for the different tubes are shown below.

Recommended Tube Type

Copper tube: copper which has been "cold rolled", cold drawn and in straight lengths.

Brass tube: in cold-rolled straight lengths (same working pressure as for copper tube).

"Coiled annealed" copper tube: reduces working pressure by 35%; must be avoided completely if vibration is present.

Steel tube: "thin wall" cold drawn, seamless, bright annealed and in straight lengths.
6 mm to 16 mm O.D.: max. wall thickness 1 mm
Above 16 mm O.D.: max. wall thickness 1.5 mm

Polyamide tube: semi-rigid
For rigid polyamide tube, multiply the figures in this table by 1.8.

Recommended Tube-Fitting Assembly Configurations

Assembled using Parker Legris brass olive and nut.

Assembled using Parker Legris steel olive and nut (nut type O110..40).

Assembled using Parker Legris brass olive and nut.

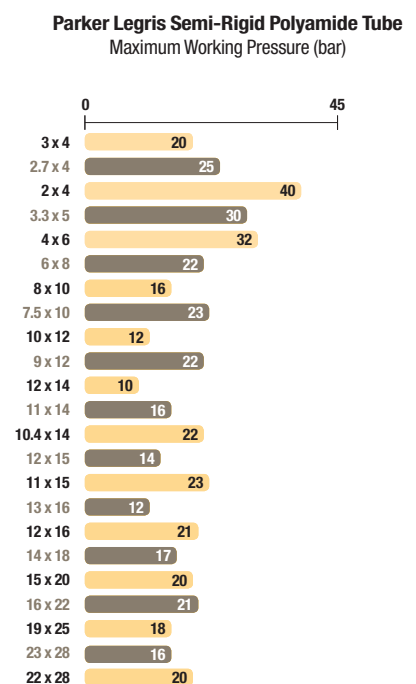
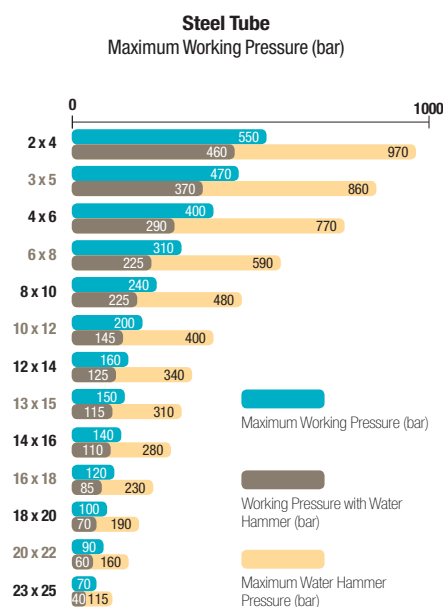
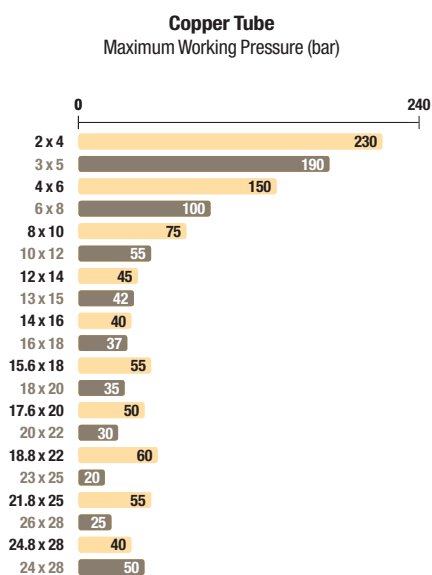

When using a plastic nut type O110..70, the maximum working pressure is 10 bar, for all diameters.

Working Pressure Coefficients for Semi-Rigid Polyamide Tubing

Temperature °C	-40°C / -15°C	-15°C / +30°C	+30°C / +50°C	+50°C / +70°C	+70°C / +100°C
Factor	1.8	1	0.68	0.55	0.31

Parker Legris brass compression fittings are not compatible with ammonia and its derivatives.

The above recommendations are given in good faith. However, since each application is different, it is advisable to undertake tests in actual working conditions.

Brass Compression Fittings

0105 Stud Fitting, Male BSPT Thread

Brass

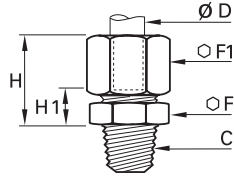



ØD	C		F	F1	H _{max}	H1	Kg
4	R1/8	0105 04 10	10	10	17	7	0.012
	R1/8	0105 05 10	11	12	17.5	7.5	0.016
5	R1/4	0105 05 13	14	12	17.5	7.5	0.023
	R1/8	0105 06 10	11	13	18	7.5	0.017
6	R1/4	0105 06 13	14	13	18	7.5	0.024
	R3/8	0105 06 17	17	13	18	8.5	0.030
	R1/8	0105 08 10	13	14	19.5	7	0.020
8	R1/4	0105 08 13	14	14	19.5	7	0.025
	R3/8	0105 08 17	17	14	20.5	8	0.032
	R1/8	0105 10 10	17	19	24	9	0.042
10	R1/4	0105 10 13	17	19	24	9	0.047
	R3/8	0105 10 17	17	19	24	9	0.048
	R1/2	0105 10 21	22	19	25	10	0.066
12	R1/4	0105 12 13	19	22	24	9	0.059
	R3/8	0105 12 17	19	22	24	9	0.060
	R1/2	0105 12 21	22	22	25	10	0.076
14	R1/4	0105 14 13	22	24	25	8	0.067
	R3/8	0105 14 17	22	24	25	8	0.068
	R1/2	0105 14 21	22	24	26	9	0.080
15	R3/4	0105 14 27	27	24	27	10	0.107
	R3/8	0105 15 17	22	24	25	8	0.066
	R1/2	0105 15 21	22	24	26	9	0.077
16	R1/4	0105 16 13	24	27	27	9.5	0.090
	R3/8	0105 16 17	24	27	27	9.5	0.092
	R1/2	0105 16 21	24	27	27	9.5	0.099
18	R3/4	0105 16 27	27	27	28	10.5	0.119
	R1/2	0105 18 21	27	30	30	10.5	0.125
	R3/4	0105 18 27	27	30	30	10.5	0.137
20	R1/2	0105 20 21	30	32	32	11	0.146
	R3/4	0105 20 27	30	32	32	11	0.157
	R1/2	0105 22 21	32	36	33	11	0.188
22	R3/4	0105 22 27	32	36	33	11	0.197
	R1	0105 22 34	36	36	33	11	0.225
	R3/4	0105 25 27	36	41	36	11	0.263
25	R1	0105 25 34	36	41	36	11	0.277
	R3/4	0105 28 27	41	42	36	11	0.273
28	R1	0105 28 34	41	42	36	11	0.284

Metric taper threads or NPT threads are available by special order, subject to minimum quantities.

0105 Stud Fitting, Male NPT Thread

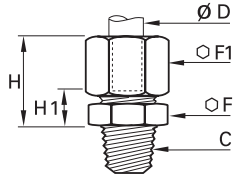
Brass



ØD	C		F	F1	H _{max}	H1	Kg
6	NPT1/8	0105 06 11	11	13	18	7.5	0.018
	NPT1/4	0105 06 14	14	13	18	7.5	0.027
8	NPT1/8	0105 08 11	13	14	21	7	0.021
	NPT1/4	0105 08 14	14	14	18.5	7	0.026
10	NPT1/4	0105 10 14	17	19	24	9	0.047
	NPT3/8	0105 10 18	17	19	24	9	0.047
	NPT1/2	0105 10 22	22	19	25	10	0.066

Related Products

Parker also offers another type of brass compression fitting: **Metrolok**, with a one-piece olive/nut. Do not hesitate to contact us.



Brass Compression Fittings

0101 Stud Fitting with Captive Sealing Washer, Male BSPP and Metric Thread

Brass, technical polymer

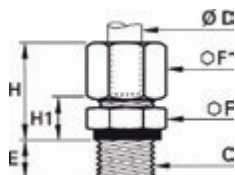

ØD	C		E	F	F1	H _{max}	H1	Kg
4	M5x0.8	0101 04 19	5	10	10	16.5	8	0.011
	G1/8	0101 04 10	6.5	13	10	16.5	8	0.016
5	G1/8	0101 05 10	6.5	13	12	17.5	8.5	0.018
	G1/8	0101 06 10	6.5	13	13	18	8.5	0.020
6	G1/4	0101 06 13	8	17	13	18	9.5	0.030
	G1/8	0101 08 10	6.5	13	14	19	8.5	0.021
8	G1/4	0101 08 13	8	17	14	19.5	9	0.031
	G3/8	0101 08 17	11	22	14	20	10.5	0.044
10	G1/4	0101 10 13	8	17	19	24	11	0.048
	G3/8	0101 10 17	11	22	19	24	11.5	0.061
12	G1/4	0101 12 13	8	19	22	24	11	0.062
	G3/8	0101 12 17	11	22	22	24	11.5	0.070
14	G1/2	0101 12 21	12	27	22	24	12	0.089
	G3/8	0101 14 17	11	22	24	25	10.5	0.074
15	G1/2	0101 14 21	12	27	24	25	11	0.093
	G3/8	0101 15 17	11	22	24	25	10.5	0.071
16	G1/2	0101 15 21	12	27	24	25	11	0.094
	G3/8	0101 16 17	11	22	27	27	12	0.091
18	G1/2	0101 16 21	12	27	27	27	12.5	0.109
	G3/4	0101 18 21	12	27	30	29.5	12.5	0.128
20	G3/4	0101 18 27	13	32	30	29.5	13	0.152
	G3/4	0101 20 27	13	32	32	31	13	0.164
22	G3/4	0101 22 27	13	32	36	32	13	0.194
	G1	0101 22 34	15	41	36	31	13.5	0.259
25	G3/4	0101 25 27	13	36	41	35.5	13	0.260
	G1	0101 25 34	15	41	41	35.5	13	0.306
28	G1	0101 28 34	15	41	42	35.5	13.5	0.299

With pre-assembled polyamide washer
Sealing washers 0602 can be found in chapter 9.

0101..39 Stud Fitting, with Bi-Material Seal, Male BSPP Thread

Brass, zinc-plated steel with NBR seal

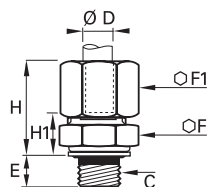

ØD	C		E	F	F1	H _{max}	H1	Kg
4	G1/8	0101 04 10 39	5.5	13	10	17.5	9	0.016
5	G1/8	0101 05 10 39	5.5	13	12	18.5	9.5	0.019
	G1/8	0101 06 10 39	5.5	13	13	19	9.5	0.020
6	G1/4	0101 06 13 39	7	17	13	19	10.5	0.030
	G1/8	0101 08 10 39	5.5	13	14	20	9.5	0.022
8	G1/4	0101 08 13 39	7	17	14	20.5	10	0.031
	G3/8	0101 08 17 39	9.5	22	14	21.5	12	0.045
10	G1/4	0101 10 13 39	7	17	19	25	12	0.048
	G3/8	0101 10 17 39	9.5	22	19	25.5	13	0.061
12	G1/4	0101 12 13 39	7	19	22	25	12	0.062
	G3/8	0101 12 17 39	9.5	22	22	25	13	0.070
14	G1/2	0101 12 21 39	10.5	27	22	25	13.5	0.090
	G3/8	0101 14 17 39	9.5	22	24	26.5	12	0.076
15	G1/2	0101 14 21 39	10.5	27	24	26.5	12.5	0.094
	G3/8	0101 15 17 39	9.5	22	24	26.5	12	0.071
16	G1/2	0101 15 21 39	10.5	27	24	26.5	12.5	0.094
	G3/8	0101 16 17 39	9.5	22	27	28.5	13.5	0.092
18	G1/2	0101 16 21 39	10.5	27	27	28.5	14	0.109
	G1/2	0101 18 21 39	10.5	27	30	31	14	0.129
20	G3/4	0101 18 27 39	11.5	32	30	31	14.5	0.154
	G3/4	0101 20 27 39	11.5	32	32	32.5	14.5	0.167
22	G3/4	0101 22 27 39	11.5	32	36	32.5	14.5	0.197
	G1	0101 22 34 39	13	41	36	33	15.5	0.259
25	G1	0101 25 34 39	13	41	41	37.5	15.5	0.309
28	G1	0101 28 34 39	13	41	42	37.5	15.5	0.300

Thread with bi-material seal
Bi-material sealing washers, part number 0139, can be found in Chapter 9

Brass Compression Fittings

0101 Stud Fitting, Male Metric Thread

Brass

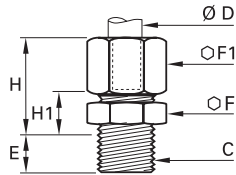

ØD	C		E	F	F1	H _{max}	H1	Kg
4	M7x1	0101 04 55	6.5	10	10	16.5	7.5	0.012
	M8x1	0101 04 56	6.5	11	10	16.5	7.5	0.013
5	M8x1	0101 05 56	6.5	11	12	17.5	8	0.015
	M10x1	0101 05 60	6.5	14	12	17.5	8.5	0.020
6	M10x1	0101 06 60	6.5	14	13	18	8.5	0.021
	M10x1.5	0101 06 62	6.5	14	13	18	8.5	0.021
8	M12x1	0101 08 65	8	17	14	19.5	9	0.029
	M12x1.25	0101 08 66	8	17	14	19.5	9	0.029
	M13x1.25	0101 08 68	8	17	14	19.5	9	0.030
10	M14x1.25	0101 10 70	8	17	19	24	11	0.048
	M14x1.5	0101 10 71	8	17	19	24	11	0.047
	M16x1.25	0101 10 74	9	19	19	24	11	0.051
12	M16x1.5	0101 10 75	9	19	19	24	11	0.051
	M18x1.5	0101 10 78	9	22	19	24	11.5	0.060
	M16x1.25	0101 12 74	9	19	22	24	11	0.061
14	M18x1.5	0101 12 75	9	19	22	24	11	0.061
	M18x1.5	0101 12 78	9	22	22	24	11.5	0.071
15	M18x1.5	0101 14 78	9	22	24	25	10.5	0.071
	M20x1.5	0101 14 80	10	24	24	25	11	0.084
16	M18x1.5	0101 15 78	9	22	24	25	10.5	0.071
	M20x1.5	0101 16 80	10	24	27	27	12.5	0.101
18	M22x1.5	0101 16 82	10	27	27	27	12.5	0.110
	M22x1.5	0101 18 82	10	27	30	29.5	12.5	0.129
	M24x1.5	0101 18 83	11	30	30	29.5	13	0.142

0114 Stud Fitting, Female BSPP Thread

Brass

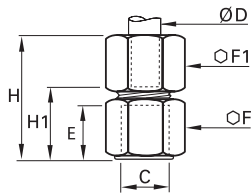

ØD	C		E	F	F1	H _{max}	H1	Kg
4	G1/8	0114 04 10	9.5	14	10	26	16.5	0.020
	G1/4	0114 04 13	13.5	17	10	30	20.5	0.030
5	G1/8	0114 05 10	9.5	14	12	28	17	0.023
	G1/4	0114 05 13	13.5	17	12	31	21	0.033
6	G1/8	0114 06 10	9.5	14	13	28	17	0.025
	G1/4	0114 06 13	13.5	17	13	32	21	0.034
8	G3/8	0114 06 17	14	22	13	32	21.5	0.051
	G1/8	0114 08 10	9.5	14	14	29	16.5	0.026
	G1/4	0114 08 13	13.5	17	14	33	20.5	0.035
10	G3/8	0114 08 17	14	22	14	34	21	0.052
	G1/4	0114 10 13	13.5	17	19	37	21.5	0.052
	G3/8	0114 10 17	14	22	19	37	22	0.068
12	G1/2	0114 10 21	18.5	27	19	42	26.5	0.100
	G3/8	0114 12 17	13.5	19	22	36	20.5	0.068
	G1/2	0114 12 21	14	22	22	37	22	0.078
14	G1/2	0114 12 21	18.5	27	22	42	26.5	0.109
	G1/4	0114 14 13	13.5	22	24	36	18.5	0.085
	G3/8	0114 14 17	14	22	24	38	21	0.048
15	G1/2	0114 14 21	18.5	27	24	43	25.5	0.112
	G3/8	0114 15 17	14	22	24	38	21	0.078
	G1/2	0114 15 21	18.5	27	24	43	25.5	0.109
16	G1/4	0114 16 13	13.5	24	27	36	18	0.107
	G3/8	0114 16 17	14	24	27	38	20.5	0.106
	G1/2	0114 16 21	18.5	27	27	44	26	0.128
18	G3/8	0114 18 17	14	27	30	39	19.5	0.140
	G1/2	0114 18 21	18.5	27	30	45	26	0.144
	G3/4	0114 18 27	19.5	32	30	46	27	0.164
20	G3/8	0114 20 17	14	30	32	38	18	0.161
	G1/2	0114 20 21	18.5	30	32	44.5	24	0.171
	G3/4	0114 20 27	19.5	32	32	47	26.5	0.171
22	G3/4	0114 22 27	19.5	32	36	48	26.5	0.203
	G3/4	0114 25 27	19.5	36	41	50.5	26	0.297

Brass Compression Fittings

Compression Fittings

Brass Compression Fittings

0109 Stud Elbow, Male BSPT Thread

Brass

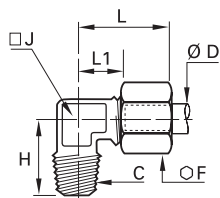

ØD	C		F	H	J	L _{max}	L1	Kg
4	R1/8	0109 04 10	10	17	8	19	9.5	0.016
	R1/4	0109 04 13	10	20	10	19	11	0.024
5	R1/8	0109 05 10	12	17.5	8	21	11	0.019
	R1/4	0109 05 13	12	21.5	10	22	12	0.029
6	R1/8	0109 06 10	13	18	8	22	11	0.021
	R1/4	0109 06 13	13	21.5	10	22	12	0.030
8	R1/8	0109 08 10	14	18.5	10	28	15	0.028
	R1/4	0109 08 13	14	22	10	28	15	0.034
	R3/8	0109 08 17	14	24	12	28	15	0.043
10	R1/4	0109 10 13	19	25	12	30	14.5	0.053
	R3/8	0109 10 17	19	25.5	12	30	14.5	0.059
	R1/2	0109 10 21	19	32	19	36	21	0.108
12	R1/4	0109 12 13	22	26	15	30	15	0.074
	R3/8	0109 12 17	22	27	15	30	15	0.077
	R1/2	0109 12 21	22	32	19	36	21	0.114
14	R3/8	0109 14 17	24	30	19	35	18	0.105
	R1/2	0109 14 21	24	32	19	35	18	0.111
15	R3/8	0109 15 17	24	30	19	35	18	0.100
	R1/2	0109 15 21	24	32	19	35	18	0.108
	R3/8	0109 16 17	27	30	19	39	21	0.121
16	R1/2	0109 16 21	27	33.5	19	39	21	0.129
	R3/4	0109 16 27	27	36.5	23	41	23	0.185
	R1/2	0109 18 21	30	35.5	23	41	21.5	0.179
18	R3/4	0109 18 27	30	36.5	23	41	21.5	0.198
	R1/2	0109 20 21	32	36.5	23	42	21.5	0.183
	R3/4	0109 20 27	32	38	23	42	21.5	0.203
22	R3/4	0109 22 27	36	40	27	50	30	0.287
	R1	0109 22 34	36	44	27	50	30	0.336
25	R3/4	0109 25 27	41	43	27	54	30	0.328
	R1	0109 25 34	41	44	27	54	30	0.368
28	R3/4	0109 28 27	42	46	32	54	30	0.404
	R1	0109 28 34	42	48	32	54	30	0.382

Metric taper threads or NPT threads are available by special order, subject to minimum quantities.

0109 Stud Elbow, Male NPT Thread

Brass

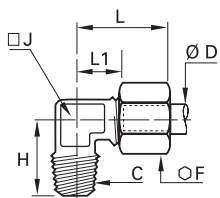

ØD	C		F	H	J	L _{max}	L1	Kg
6	NPT1/8	0109 06 11	13	18	8	22	11	0.021
	NPT1/4	0109 06 14	13	21.5	10	22	12	0.030
8	NPT1/8	0109 08 11	14	18.5	10	28	15	0.028
	NPT1/4	0109 08 14	14	22	10	28	15	0.033
10	NPT1/4	0109 10 14	19	25	12	30	14.5	0.053

0199 Stud Orientable Elbow, Male BSPP Thread

Brass, NBR

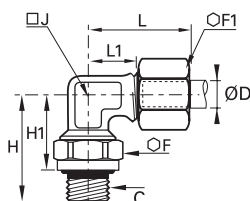

ØD	C		F	F1	H	H1	H1 _{max}	J	L _{max}	L1	Kg
4	G1/8	0199 04 10	14	10	23	16	17	8	19	9.5	0.022
	G1/4	0199 04 13	19	10	30.5	22	23.5	10	19	11	0.043
6	G1/8	0199 06 10	14	13	23	16	17	8	22	11	0.027
	G1/4	0199 06 13	19	13	30.5	22	23.5	10	22	12	0.046
8	G1/8	0199 08 10	14	14	24	17	18	10	28	15	0.034
	G1/4	0199 08 13	19	14	30.5	22	23.5	10	28	15	0.049
	G3/8	0199 08 17	22	14	33.5	24	25.5	12	28	15	0.065
10	G1/4	0199 10 13	19	19	31	22.5	24	12	30	14.5	0.067
	G3/8	0199 10 17	22	19	33.5	24	25.5	12	30	14.5	0.078
	G1/2	0199 10 21	27	19	40	29.5	31	19	37	22	0.137
14	G3/8	0199 14 17	22	24	35.5	26	27.5	19	35	18	0.118
	G1/2	0199 14 21	27	24	40	29.5	31	19	35	18	0.140
	G1/2	0199 18 21	27	30	40	29	30.5	23	41	21.5	0.187
18	G3/4	0199 18 27	32	30	43.5	32	33.5	23	41	21.5	0.222
	G3/4	0199 22 27	32	36	45.5	34	36	32	51	31	0.385
22	G1	0199 22 34	41	36	54	40.5	43	32	51	31	0.409
	G1	0199 28 34	41	42	54	40.5	43	32	54	30	0.411

The body will orientate for positioning purposes.

Brass Compression Fittings

0108

Stud Branch Tee, Male BSPT Thread

Brass

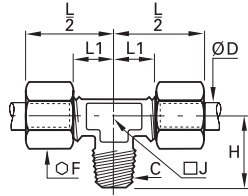

ØD	C		F	H	J	L1	L/2	Kg
4	R1/8	0108 04 10	10	17	8	9.5	19	0.025
5	R1/8	0108 05 10	12	17.5	8	11	21	0.031
6	R1/8	0108 06 10	13	18	8	11	22	0.033
	R1/4	0108 06 13	13	21.5	10	16	27	0.047
8	R1/8	0108 08 10	14	18.5	10	15	28	0.043
	R1/4	0108 08 13	14	22	10	15	28	0.050
10	R3/8	0108 08 17	14	24	12	15	28	0.061
	R1/4	0108 10 13	19	25	12	14.5	30	0.085
12	R3/8	0108 10 17	19	25.5	12	14.5	30	0.092
	R1/4	0108 12 13	22	26	15	15	30	0.114
14	R3/8	0108 12 17	22	27	15	15	30	0.117
	R3/8	0108 14 17	24	30	19	18	35	0.159
15	R1/2	0108 14 21	24	32	19	18	35	0.166
	R3/8	0108 15 17	24	30	19	18	35	0.147
16	R1/2	0108 15 21	24	32	19	18	35	0.155
	R3/8	0108 16 17	27	30	19	21	39	0.190
18	R1/2	0108 16 21	27	33.5	19	21	39	0.203
	R1/2	0108 18 21	30	35.5	23	21.5	41	0.270
20	R3/4	0108 18 27	30	36.5	23	21.5	41	0.292
	R3/4	0108 20 27	32	38	23	21.5	42	0.299
22	R3/4	0108 22 27	36	40	27	29	50	0.431
	R1	0108 22 34	36	44	27	29	50	0.466

Metric taper threads or NPT threads are available by special order, subject to minimum quantities.

0103

Stud Run Tee, Male BSPT Thread

Brass

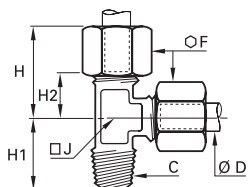

ØD	C		F	H _{max}	H1	H2	J	Kg
4	R1/8	0103 04 10	10	19	17	9.5	8	0.025
5	R1/8	0103 05 10	12	21	17.5	11	8	0.030
6	R1/8	0103 06 10	13	22	18	11	8	0.033
	R1/4	0103 06 13	13	27	21.5	16	10	0.046
8	R1/8	0103 08 10	14	28	18.5	15	10	0.044
	R1/4	0103 08 13	14	28	22	15	10	0.049
10	R3/8	0103 08 17	14	28	24	15	12	0.061
	R1/4	0103 10 13	19	30	25	14.5	12	0.084
12	R3/8	0103 10 17	19	30	25.5	14.5	12	0.091
	R1/4	0103 12 13	22	30	26	15	15	0.114
14	R3/8	0103 12 17	22	30	27	15	15	0.121
	R3/8	0103 14 17	24	35	30	18	19	0.161
15	R1/2	0103 14 21	24	35	32	18	19	0.171
	R3/8	0103 15 17	24	35	30	18	19	0.148
16	R1/2	0103 15 21	24	35	32	18	19	0.158
	R3/8	0103 16 17	27	39	30	21	19	0.188
18	R1/2	0103 16 21	27	39	33.5	21	19	0.202
	R1/2	0103 18 21	30	41	35.5	21.5	23	0.269
20	R3/4	0103 18 27	30	41	36.5	21.5	23	0.291
	R3/4	0103 20 27	32	42	38	21.5	23	0.298
22	R3/4	0103 22 27	36	50	40	29	27	0.435

Metric taper threads or NPT threads are available by special order, subject to minimum quantities.

Related Products

Parker also offers another type of brass compression fitting: **Metrulok**, with a one-piece olive/nut. Do not hesitate to contact us.



Brass Compression Fittings

0118 Single Banjo with Captive Sealing Washer, Male BSPP Thread

Brass, technical polymer

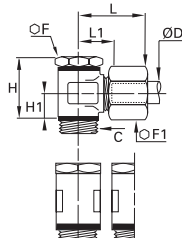

ØD	C		F	F1	H	H1	L _{max}	L1	N	Kg
4	G1/8	0118 04 10	14	10	24	9.5	24	14.5	17.5	0.038
	G1/8	0118 05 10	14	12	24	9.5	25	14.5	17.5	0.041
5	G1/4	0118 05 13	17	12	25	10	26	16	21	0.058
	G1/8	0118 06 10	14	13	24	9.5	25	14.5	17.5	0.041
6	G1/4	0118 06 13	17	13	25	10	26	16	21	0.056
	G1/8	0118 08 10	14	14	24	9.5	28	15.5	17.5	0.055
8	G1/4	0118 08 13	17	14	25	10	28	15.5	21	0.058
	G3/8	0118 08 17	22	14	32	13	30	18	26.5	0.110
10	G1/4	0118 10 13	17	19	31	13	34	19	23	0.117
	G3/8	0118 10 17	22	19	32	13	34	19	26.5	0.125
12	G1/4	0118 12 13	17	22	34	14.5	34	19	23	0.126
	G3/8	0118 12 17	22	22	35	14.5	34	19	26.5	0.138
14	G1/4	0118 14 13	17	24	37	16	37	20.5	28	0.154
	G3/8	0118 14 17	22	24	38	16	37	20.5	28	0.202
15	G1/2	0118 14 21	27	24	40	16	38	20.5	32.5	0.202
	G3/8	0118 15 17	22	24	38	16	37	20.5	28	0.189
16	G1/2	0118 15 21	27	24	40	16	38	20.5	32.5	0.196
	G1/2	0118 16 21	27	27	42	16	38	21	32.5	0.219
18	G1/2	0118 18 21	27	30	46	19.5	43	24.5	36	0.362
20	G3/4	0118 20 27	32	32	49	20	44	24.5	39	0.406
22	G3/4	0118 22 27	32	36	53	22	45	24.5	39	0.454

Thread with pre-assembled washer
Sealing washers 0602 can be found in chapter 9.

0118..39 Single Banjo with Bi-Material Seal, Male BSPP Thread

Brass, zinc-plated steel with NBR seal

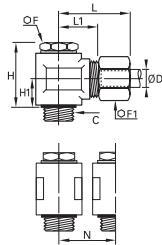

ØD	C		F	F1	H	H1	L _{max}	L1	N	Kg
4	G1/8	0118 04 10 39	14	10	23	9.5	24	14.5	17.5	0.039
	G1/8	0118 05 10 39	14	12	23	9.5	25	14.5	17.5	0.041
5	G1/4	0118 05 13 39	17	12	24	10	26	16	21	0.064
	G1/8	0118 06 10 39	14	13	23	9.5	25	14.5	17.5	0.042
6	G1/4	0118 06 13 39	17	13	24	10	26	16	21	0.057
	G1/8	0118 08 10 39	14	14	23	9.5	28	15.5	17.5	0.056
8	G1/4	0118 08 13 39	17	14	24	10	28	15.5	21	0.059
	G3/8	0118 08 17 39	22	14	31.5	13.5	30	18	26.5	0.113
10	G1/4	0118 10 13 39	17	19	30	13	34	19	23	0.119
	G3/8	0118 10 17 39	22	19	31.5	13.5	34	19	26.5	0.127
12	G1/4	0118 12 13 39	17	22	33	14.5	34	19	23	0.126
	G3/8	0118 12 17 39	22	22	34.5	15	34	19	26.5	0.136
14	G1/4	0118 14 13 39	17	24	36	16	37	20.5	28	0.190
	G3/8	0118 14 17 39	22	24	37.5	16.5	37	20.5	28	0.198
15	G1/2	0118 14 21 39	27	24	39	16.5	38	20.5	32.5	0.206
	G1/2	0118 15 21 39	27	24	40	16.5	38	20.5	32.5	0.202
16	G1/2	0118 16 21 39	27	27	40	16.5	38	21	32.5	0.222
	G1/2	0118 18 21 39	27	30	47	20	43	24.5	36	0.365
20	G3/4	0118 20 27 39	32	32	50	20.5	44	24.5	39	0.394
22	G3/4	0118 22 27 39	32	36	54	22.5	45	24.5	39	0.462

With bi-material sealing washer
The bi-material sealing washers, part number 0139, can be found in chapter 9.

Brass Compression Fittings

0119 Double Banjo with Captive Sealing Washer, Male BSPP Thread

Brass, technical polymer

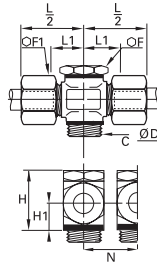

ØD	C		F	F1	H	H1	L1	L/2	N	Kg
4	G1/8	0119 04 10	14	10	24	9.5	14.5	24	17.5	0.051
	G1/8	0119 06 10	14	13	24	9.5	14.5	25	17.5	0.056
6	G1/4	0119 06 13	17	13	25	10	16	26.5	21	0.073
	G1/8	0119 08 10	14	14	24	9.5	15.5	28	17.5	0.070
8	G1/4	0119 08 13	17	14	25	10	15.5	28	21	0.075
	G3/8	0119 08 17	22	14	32	13	18	30.5	26.5	0.140
10	G1/4	0119 10 13	17	19	31	13	19	34	23	0.156
	G3/8	0119 10 17	22	19	32	13	19	34	26.5	0.173
12	G1/4	0119 12 13	17	22	34	14.5	19	34	23	0.173
	G3/8	0119 12 17	22	22	35	14.5	19	34	26.5	0.182
14	G1/4	0119 14 13	17	24	37	16	20.5	37.5	28	0.246
	G3/8	0119 14 17	22	24	38	16	20.5	37.5	28	0.245
	G1/2	0119 14 21	27	24	40	16	20.5	38	32.5	0.219

Thread with pre-assembled washer

Sealing washers 0602 can be found in Chapter 9.

0119..39 Double Banjo with Bi-Material Seal, Male BSPP Thread

Brass, zinc-plated steel with NBR seal

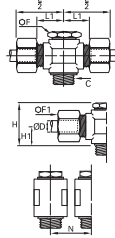

ØD	C		F	F1	H	H1	L1	L/2	N	Kg
4	G1/8	0119 04 10 39	14	10	23	9.5	14.5	24	17.5	0.050
	G1/8	0119 05 10 39	14	12	23	9.5	14.5	25	17.5	0.049
5	G1/4	0119 05 13 39	17	12	24	10	12.6	26	21	0.072
	G1/8	0119 06 10 39	14	13	23	9.5	14.5	25	17.5	0.057
6	G1/4	0119 06 13 39	17	13	24	10	16	26	21	0.071
	G1/8	0119 08 10 39	14	14	23	9.5	15.5	28	17.5	0.071
8	G1/4	0119 08 13 39	17	14	24	10	15.5	28	21	0.075
	G3/8	0119 08 17 39	22	14	31.5	13.5	18	30	26.5	0.137
10	G1/4	0119 10 13 39	17	19	30	13	19	34	23	0.156
	G3/8	0119 10 17 39	22	19	31.5	13.5	19	34	26.5	0.167
12	G1/4	0119 12 13 39	17	22	33	14.5	19	34	23	0.180
	G1/4	0119 14 13 39	17	24	36	16	20.5	37	28	0.248
14	G3/8	0119 14 17 39	22	24	37.5	16.5	20.5	37	28	0.247
	G1/2	0119 14 21 39	27	24	39	16.5	20.5	38	32.5	0.261
15	G3/8	0119 15 17 39	22	24	37.5	16.5	20.5	37	28	0.246
	G1/2	0119 15 21 39	27	24	40	16.5	20.5	38	32.5	0.251
18	G1/2	0119 18 21 39	27	30	47	20	24.5	43	36	0.471
20	G3/4	0119 20 27 39	32	32	50	20.5	24.5	44	39	0.638
22	G3/4	0119 22 27 39	32	36	54	22.5	24.5	45	39	0.610

Thread with pre-assembled washer

Bi-material sealing washers, part number 0139, can be found in Chapter 9.

0106 Equal Tube-to-Tube Connector

Brass

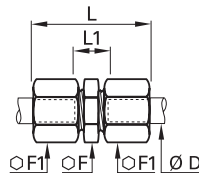

ØD		F	F1	L _{max}	L1	Kg
4	0106 04 00	10	10	28	10	0.017
5	0106 05 00	11	12	31	11	0.024
6	0106 06 00	11	13	32	11	0.026
8	0106 08 00	13	14	36	10	0.031
10	0106 10 00	17	19	42	13	0.070
12	0106 12 00	19	22	42	13	0.091
14	0106 14 00	22	24	45	11	0.103
15	0106 15 00	22	24	45	11	0.098
16	0106 16 00	24	27	48	13	0.142
18	0106 18 00	27	30	53	14	0.188
20	0106 20 00	30	32	56	14	0.215
22	0106 22 00	32	36	60	14	0.282
25	0106 25 00	36	41	64	14	0.401
28	0106 28 00	41	42	64	14	0.397

Brass Compression Fittings

0113 Equal Tube-to-Tube Connector with Mounting Boss

Brass

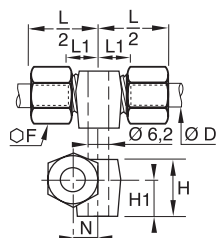

ØD		F	H	H1	L1	L/2	N	Kg
4	0113 04 00	10	10.5	7	9.5	19	6	0.021
6	0113 06 00	13	13	9	10	20.5	7	0.033
8	0113 08 00	14	14.5	9.5	11	23.5	8	0.040
10	0113 10 00	19	19.5	12.5	11	26	9	0.081
12	0113 12 00	22	22	14	12	26.5	11	0.108
14	0113 14 00	24	25	16	11	28	12	0.124

0116 Equal Bulkhead Connector

Brass

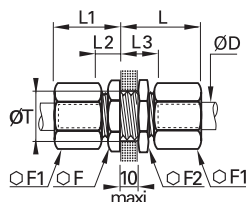

ØD		F	F1	F2	L max	L1 max	L2	L3	ØT min	Kg
4	0116 04 00	10	10	13	27	17	7	17	8.3	0.024
5	0116 05 00	13	12	14	28	18	7.5	17.5	10.3	0.035
6	0116 06 00	13	13	14	28	19	7.5	17.5	10.3	0.037
8	0116 08 00	14	14	17	29	20	7	17	12.3	0.045
10	0116 10 00	19	19	22	33	25	9	19	16.5	0.100
12	0116 12 00	22	22	22	33	25	9	19	18.5	0.121
14	0116 14 00	24	24	27	35	25	8	18	20.5	0.144
15	0116 15 00	24	24	24	35	25	8	18	20.5	0.134
16	0116 16 00	27	27	27	36	28	9.5	19.5	22.5	0.188
18	0116 18 00	27	30	30	40	30	10.5	20.5	24.5	0.238
20	0116 20 00	32	30	32	41	31	11	21	27.5	0.275
22	0116 22 00	36	36	36	42	32	11	21	30.5	0.376
25	0116 25 00	36	41	38	46	36	11	21	33.5	0.479

0102 Equal Elbow

Brass

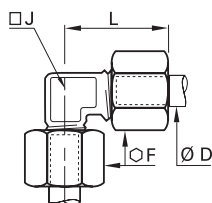

ØD		F	J	L max	Kg
4	0102 04 00	10	5	19	0.016
5	0102 05 00	12	8	21	0.025
6	0102 06 00	13	8	22	0.027
8	0102 08 00	14	10	28	0.038
10	0102 10 00	19	12	30	0.072
12	0102 12 00	22	15	30	0.098
14	0102 14 00	24	19	35	0.133
15	0102 15 00	24	19	35	0.123
16	0102 16 00	27	19	39	0.165
18	0102 18 00	30	23	41	0.230
20	0102 20 00	32	23	42	0.236
22	0102 22 00	36	27	50	0.373
25	0102 25 00	41	27	54	0.452
28	0102 28 00	42	32	54.5	0.474

Related Products

Parker also offers another type of brass compression fitting:

Metrolok, with a one-piece olive/nut.

Do not hesitate to contact us.



Brass Compression Fittings

0104 Equal Tee

Brass

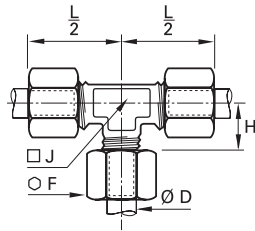

ØD		F	H	J	L/2	Kg
4	0104 04 00	10	9.5	8	19	0.028
5	0104 05 00	12	11	8	21	0.036
6	0104 06 00	13	11	8	22	0.040
8	0104 08 00	14	15	10	28	0.055
10	0104 10 00	19	14.5	12	30	0.105
12	0104 12 00	22	15	15	30	0.141
14	0104 14 00	24	18	19	35	0.186
15	0104 15 00	24	18	19	35	0.174
16	0104 16 00	27	21	19	39	0.234
18	0104 18 00	30	21.5	23	41	0.319
20	0104 20 00	32	21.5	23	42	0.330
22	0104 22 00	36	29	27	50	0.516
25	0104 25 00	41	29	27	54	0.637
28	0104 28 00	42	30	32	55	0.661

0142 Equal Y Piece with Mounting Boss

Brass

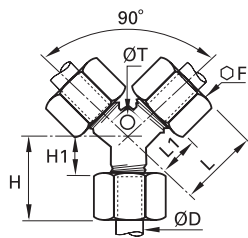

ØD		F	H max	H1	L max	L1	ØT	Kg
4	0142 04 00	10	16.5	7	26.5	17	4.2	0.032
6	0142 06 00	13	19.5	8.5	28	17	4.2	0.049
8	0142 08 00	14	21	8	30	17	6.2	0.061
10	0142 10 00	19	24.5	9	37.5	22	6.2	0.128
12	0142 12 00	22	26	11	38	23	6.2	0.110
14	0142 14 00	24	28	11	41.5	24.5	6.2	0.201
15	0142 15 00	24	28	11	41.5	24.5	6.2	0.204
16	0142 16 00	27	30	12	43	25	6.2	0.252
18	0142 18 00	30	31.5	12	50.5	31	10.2	0.353

0107 Equal Cross

Brass

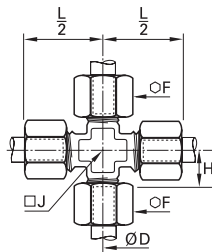

ØD		F	H	J	L/2	Kg
4	0107 04 00	10	9.5	8	19	0.035
5	0107 05 00	12	11	8	21	0.047
6	0107 06 00	13	11	8	22	0.052
8	0107 08 00	14	15	11	28	0.074
10	0107 10 00	19	14.5	14	30	0.142
12	0107 12 00	22	15	15	35	0.234
14	0107 14 00	24	18	20	35	0.246
15	0107 15 00	24	18	20	35	0.224
16	0107 16 00	27	21	20	39	0.309
18	0107 18 00	30	21.5	25	41	0.423
20	0107 20 00	32	21.5	25	42	0.429
22	0107 22 00	36	29	27	50	0.670
25	0107 25 00	41	29	27	50	0.833

Complementary Brass Fittings

Reducers, Olives and Nuts

This innovative reducer system, using a full range of nuts and olives, enables **different diameters** of steel, copper, brass or polymer tubes to be fitted onto **a single Parker Legris compression fitting**.

Product Advantages

Efficient Solution

Reduces envelope dimensions
Quick and easy to assemble, whatever the diameters and tube material
Improved stock management
Silicone-free

Multiple Combinations

A single connector for up to 4 different tube materials and sizes
Example:

- polymer tube 4 mm O.D.
- copper tube 8 mm O.D.
- brass tube 12 mm O.D.
- braided PVC hose 12 mm I.D.

 A full range of olives and nuts to optimise all assembly operations



Pneumatics
Cooling
Automotive Process
Lubrication
Fluid Transmission
Packaging
Industrial Machinery

Applications

Regulations

DI: 97/23/EC (PED)
RG: 1907/2006 (REACH)
DI: 2002/95/EC (RoHS)
DI: 94/9/EC (ATEX)

Reducer Assembly Procedure

Operation	Assembly Sequence	Assembled Fitting
<p>1 Assemble the reducer Place the reducer in the fitting body.</p>	<p>1</p>	
<p>2 Assemble the nut and olive Place the nut and then the olive onto the tube.</p>	<p>2</p>	
<p>3 Assemble the nut Push the tubing into the fitting until it butts against the tube reducer. Tighten the nut to the recommended torque (see opposite page).</p>	<p>3</p>	

Complementary Brass Fittings

Assembly Configuration

The table and information given below illustrate the large number of options available with Parker Legris brass compression fittings. To these must be added the advantages specific to the original Parker Legris reducer shown on the previous page.



0110 Brass			0110..60 Brass		0110..40 Steel	0110..70* Polymer
	0124 Brass	0111 BNA** Brass	0124 Brass	0111 BNA** Brass	0124...40 Steel	
No olive required to assemble the plug						No olive required to assemble the tube
Brass plug: 0126	Copper, cold-rolled brass, polymer tube and barb connectors 0122 and 0165	Coiled annealed copper tube	Cold-rolled copper tube for vibration and side loading, etc.	Coiled annealed copper tube for vibration and side loading, etc.	Steel or copper tube: low/medium hydraulic pressure, lubricate before assembly	Polymer tube

*Assembly specifications for nut-olive 0110..70

This part functions as both olive and nut for flexible polymer tube assemblies:

1. Hand tighten the polymer nut-olive a few turns onto the body of the fitting; the knurling makes this easier.
2. Then introduce the polymer tube and push home into the body of the fitting.
3. Continue manually tightening the polymer nut-olive.
4. Finish tightening using a spanner until the nut body disengages and turns freely, which acts as a torque limiter.

N.B.: To avoid damaging the threads, do not insert the tube before hand tightening the nut-olive into the body of the fitting.

**Bureau de Normalisation de l'Automobile (French Automotive Bureau of Standards)

Recommended Tightening Torque

Tightening torque

in daN.m =

maximum tightening torque of a **0110** nut and **0124** olive with copper, brass or steel tube.

Nut **0110** and **0110..40**

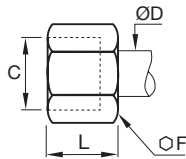

Nut **0110..60**

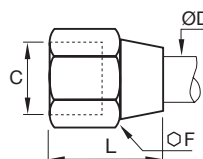

Ø D (mm)	ØF 0110	ØF 0110..60	max. daN.m copper or brass	ØF 0110..40	max. daN.m steel
4	10	11	0.7	10	1.5
5	12	13	0.7	12	1.5
6	13	13	1.5	13	2.5
8	14	16	1.5	14	2.5
10	19	20	1.8	19	3
12	22	22	3	22	4.5
14	24	24	3.5	24	5.5
15	24	24	4	24	6
16	27	27	5	27	7
18	30	30	6	30	9
20	32	32	6	32	10
22	36	36	7	36	12
25	41	41	8	41	13
28	42		9		

Complementary Brass Compression Fittings

0166

3-Piece Reducer

Brass

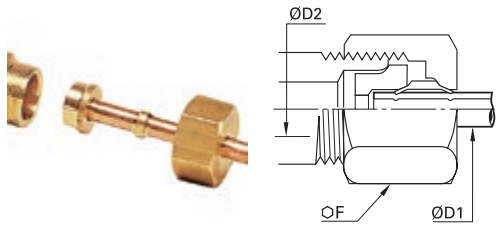

	ØD1	ØD2		F	Kg
4	5		0166 04 05	13	0.011
	6		0166 04 06	13	0.011
	8		0166 04 08	14	0.012
	10		0166 04 10	19	0.030
	12		0166 04 12	22	0.044
	14		0166 04 14	24	0.054
5	15		0166 04 15	24	0.056
	6		0166 05 06	13	0.011
	8		0166 05 08	14	0.012
	10		0166 05 10	19	0.030
	12		0166 05 12	22	0.044
	14		0166 05 14	24	0.053
6	16		0166 05 16	27	0.078
	8		0166 06 08	14	0.011
	10		0166 06 10	19	0.030
	12		0166 06 12	22	0.043
	14		0166 06 14	24	0.052
	15		0166 06 15	24	0.054
8	16		0166 06 16	27	0.077
	10		0166 08 10	19	0.027
	12		0166 08 12	22	0.040
	14		0166 08 14	24	0.050
	15		0166 08 15	24	0.052
	16		0166 08 16	27	0.077
10	18		0166 08 18	30	0.099
	12		0166 10 12	22	0.037
	14		0166 10 14	24	0.045
	15		0166 10 15	24	0.047
	16		0166 10 16	27	0.068
	18		0166 10 18	30	0.095
12	20		0166 10 20	32	0.107
	22		0166 10 22	36	0.146
	25		0166 10 25	41	0.209
	14		0166 12 14	24	0.042
	15		0166 12 15	24	0.044
	16		0166 12 16	27	0.066
14	18		0166 12 18	30	0.091
	20		0166 12 20	32	0.102
	22		0166 12 22	36	0.141
	25		0166 12 25	41	0.200
	16		0166 14 16	27	0.060
	18		0166 14 18	30	0.085
15	20		0166 14 20	32	0.095
	22		0166 14 22	36	0.134
	25		0166 14 25	41	0.189
	18		0166 15 18	30	0.081
	22		0166 15 22	36	0.130
	18		0166 16 18	30	0.078
16	20		0166 16 20	32	0.087
	22		0166 16 22	36	0.125
	25		0166 16 25	41	0.185
	20		0166 18 20	32	0.082
	22		0166 18 22	36	0.118
	25		0166 18 25	41	0.180
18	28		0166 18 28	42	0.177
	20	25	0166 20 25	41	0.168
	22	28	0166 22 28	42	0.168

ØD1: tube to be fitted

ØD2: for a x mm fitting

Each of the above part numbers comprises:

- a reduction piece
- an olive, PN 0124
- a sleeve nut

Complementary Brass Compression Fittings

0124 Brass Olive

Brass

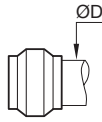

ØD		Kg
4	0124 04 00	0.001
5	0124 05 00	0.001
6	0124 06 00	0.001
8	0124 08 00	0.001
10	0124 10 00	0.003
12	0124 12 00	0.004
14	0124 14 00	0.005
15	0124 15 00	0.004
16	0124 16 00	0.006
18	0124 18 00	0.007
20	0124 20 00	0.009
22	0124 22 00	0.012
25	0124 25 00	0.017
28	0124 28 00	0.017

0124..40 Steel Olive

Zinc-plated steel

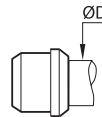

ØD		Kg
4	0124 04 00 40	0.001
6	0124 06 00 40	0.001
8	0124 08 00 40	0.001
10	0124 10 00 40	0.003
12	0124 12 00 40	0.003
14	0124 14 00 40	0.005
15	0124 15 00 40	0.004
16	0124 16 00 40	0.006
18	0124 18 00 40	0.007
20	0124 20 00 40	0.008
22	0124 22 00 40	0.010
25	0124 25 00 40	0.014

0111 BNA* Brass Olive

Brass

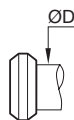

ØD		Kg
4	0111 04 00	0.001
5	0111 05 00	0.001
6	0111 06 00	0.001
8	0111 08 00	0.001
10	0111 10 00	0.002
12	0111 12 00	0.002
14	0111 14 00	0.002
15	0111 15 00	0.003
16	0111 16 00	0.003

*Bureau de Normalisation de l'Automobile

Related Products

Parker also offers another type of brass compression fitting: **Metrulok**, with a one-piece olive/nut.

Do not hesitate to contact us.



Complementary Brass Compression Fittings

0110 Brass Nut

Brass

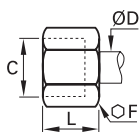

ØD	C		F	L	Kg
4	M8x1	0110 04 00	10	11	0.005
5	M10x1	0110 05 00	12	11	0.006
6	M10x1	0110 06 00	13	11	0.008
8	M12x1	0110 08 00	14	13	0.009
10	M16x1.5	0110 10 00	19	15	0.018
12	M18x1.5	0110 12 00	22	15	0.026
14	M20x1.5	0110 14 00	24	15	0.029
15	M20x1.5	0110 15 00	24	15	0.029
16	M22x1.5	0110 16 00	27	17	0.042
18	M24x1.5	0110 18 00	30	18	0.055
20	M27x1.5	0110 20 00	32	18	0.057
22	M30x1.5	0110 22 00	36	19	0.080
25	M33x1.5	0110 25 00	41	21	0.121
28	M36x1.5	0110 28 00	42	21	0.108

0110..40 Steel Nut

Zinc-plated steel

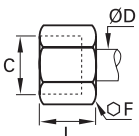

ØD	C		F	L	Kg
4	M8x1	0110 04 00 40	10	11	0.004
5	M10x1	0110 05 00 40	12	11.5	0.006
6	M10x1	0110 06 00 40	13	12	0.008
8	M12x1	0110 08 00 40	14	13.5	0.008
10	M16x1.5	0110 10 00 40	19	16	0.018
12	M18x1.5	0110 12 00 40	22	16.5	0.026
14	M20x1.5	0110 14 00 40	24	17	0.030
15	M20x1.5	0110 15 00 40	24	17	0.030
16	M22x1.5	0110 16 00 40	27	18	0.043
18	M24x1.5	0110 18 00 40	30	19	0.057
20	M27x1.5	0110 20 00 40	32	20.5	0.061
22	M30x1.5	0110 22 00 40	36	21.5	0.085

0110..60 Brass Long Nut

Brass

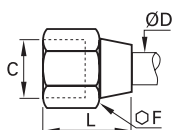

ØD	C		F	L	Kg
4	M8x1	0110 04 00 60	11	14.5	0.007
5	M10x1	0110 05 00 60	13	17	0.008
6	M10x1	0110 06 00 60	13	17.5	0.011
8	M12x1	0110 08 00 60	16	20	0.019
10	M16x1.5	0110 10 00 60	20	23	0.032
12	M18x1.5	0110 12 00 60	22	25	0.039
14	M20x1.5	0110 14 00 60	24	30	0.051
15	M20x1.5	0110 15 00 60	24	30	0.049
18	M24x1.5	0110 18 00 60	30	35	0.098
20	M27x1.5	0110 20 00 60	32	35	0.102
22	M30x1.5	0110 22 00 60	36	36	0.129

0110..70 Technical Polymer Nut-Olive

Technical polymer

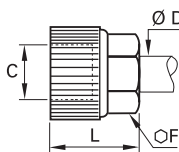

ØD	C		F	L	Kg
4	M8x1	0110 04 00 70	8	13	0.008
6	M10x1	0110 06 00 70	11	15	0.002
8	M12x1	0110 08 00 70	13	16	0.002
10	M16x1.5	0110 10 00 70	17	19	0.004
12	M18x1.5	0110 12 00 70	19	19	0.005
14	M20x1.5	0110 14 00 70	22	20	0.005

NB: polymer nut-olives should not be used on metal tubes.



Brass Compression Fittings

Compression Fittings

Self-Fastening Barb Connectors for NBR Hose

This range of fittings is designed to meet the requirements of the automotive and robotics industries, combining as it does **optimum CNOMO manufacturing quality**, simple installation, reliable operation and a **long service life**.

Product Advantages

Perfect for Self-Fastening NBR Hose

- Quick and simple to install
- Compatible with the Parker Legris range of brass compression fittings
- Mechanical properties proven for use in industrial robotic installations
- Spark-resistant

Ergonomic and Time-Saving

- Fitting does not require lubrication or clamping, reducing assembly time
- Visual stop confirms installation is correct and improves operating safety
- Removal by cutting the tube
- The fitting can be re-used if necessary



- Applications**
- Welding Robots
 - Pneumatics
 - Compressed Air Systems
 - Automotive Process
 - Cooling

Technical Characteristics

Compatible Fluids	Coolants, compressed air
Working Pressure	0 to 16 bar
Working Temperature	0°C to +100°C (water) -20°C to +70°C (air)

Tightening Torque, Type 0132	DN	6	8	10	14	18	22
	daN.m	0.7	1.5	1.8	3.5	6	7

Reliable performance is dependent upon the type of fluid conveyed and hose being used.

Component Materials

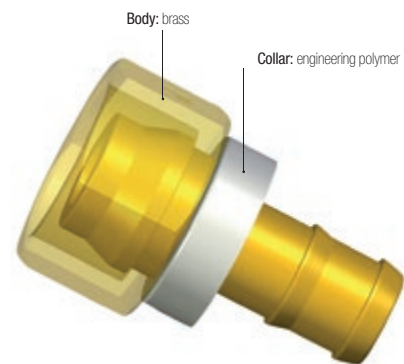

Silicone-free

Self-Fastening Hose Assembly Machine

Machine designed to assemble a barb connector and a self-fastening NBR hose.

Machine part number: **0650 00 00 05**



Tube Cutting and Positioning

Cut the hose square and position the barb connector on the mounting tool.

Barb Connector Support

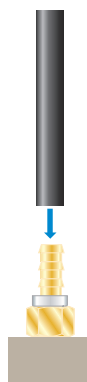

Press-Fitting the Tube

Activate the press-fit tool; connection is complete when the tube is fully home on the barb connector. This tool has been designed for use with 5 different diameters and is easy to operate.

Barb Connector Support

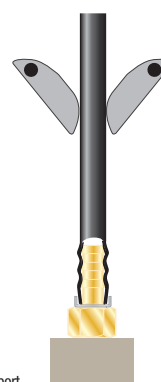

Regulations

Industrial

DI: 2002/95/EC (RoHS), 2011/65/EC
DI: 97/23/EC (PED)
RG: 1907/2006 (REACH)
CNOMO: E07.21.115N

Self-Fastening Barb Connectors for NBR Hose

0132 Self-Fastening Barb Connector for Brass Compression Fitting

Brass

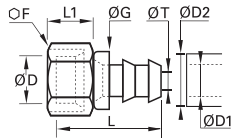

ØD	ØD1	ØD2		F	G	L	L1	ØT	Kg
6	6.3	13	0132 06 56	12	16.5	32.5	12.5	4.8	0.010
8	6.3	13	0132 08 56	14	16.5	29.5	11.5	4.8	0.015
10	6.3	13	0132 10 56	19	16.5	30	14	4.8	0.028
	9.5	16	0132 10 60	19	19.5	34	14	7.5	0.030
14	9.5	16	0132 14 60	24	19.5	35.5	15	7.5	0.050
	12.7	19	0132 14 62	24	23.5	39.5	15	10	0.054
18	12.7	19	0132 18 62	30	23.5	41.5	17	10	0.090
	15.9	23	0132 18 66	30	27	50	17	13.5	0.090
22	19.1	27	0132 22 69	36	30.5	56.5	17	16	0.128

Polymer collar

0133..39 Self-Fastening Bar Connector with Bi-Material Seal, Male BSPP Thread

Brass, zinc-plated steel with NBR seal

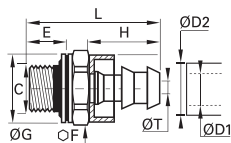

ØD1	ØD2	C		E	F	G	H	L	ØT	Kg
6.3	13	G1/8	0133 56 10 39	5.5	13	14	20	31.5	4.8	0.012
		G1/4	0133 56 13 39	7	17	17	20	33.5	4.8	0.018
9.5	16	G1/4	0133 60 13 39	7	17	17	24	37.5	7.5	0.021
		G3/8	0133 60 17 39	9.5	22	22	24	42.5	7.5	0.038
12.7	19	G3/8	0133 62 17 39	9.5	22	22	28	46.5	10	0.044
		G1/2	0133 62 21 39	10.5	27	26	28	48.5	10	0.060
15.9	23	G1/2	0133 66 21 39	10.5	27	26	36.5	57	13.5	0.063
		G3/4	0133 66 27 39	11.5	32	32	36.5	59	13.5	0.096
19.1	27	G3/4	0133 69 27 39	11.5	32	32	43	65.5	16	0.111

Thread with bi-material seal and polymer collar

Bi-material sealing washers part number 0139 can be found in chapter 9.

0134 Self-Fastening Barb Connector, Male BSPT Thread

Brass

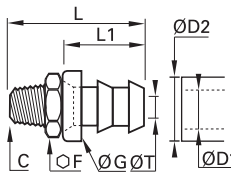

ØD1	ØD2	C		F	G	L	L1	ØT	Kg
6.3	13	R1/8	0134 56 10	14	16.5	32.5	20	4.8	0.015
		R1/4	0134 56 13	14	16.5	37	20	4.8	0.020
9.5	16	R1/4	0134 60 13	14	19.5	41	24	7.5	0.022
		R3/8	0134 60 17	19	19.5	41.5	24	7.5	0.036
12.7	19	R3/8	0134 62 17	19	23.5	45.5	28	10	0.038
		R1/2	0134 62 21	22	23.5	50	28	10	0.062
15.9	23	R1/2	0134 66 21	22	27	58.5	36.5	13.5	0.056
		R3/4	0134 66 27	27	27	60.5	36.5	13.5	0.101
19.1	27	R3/4	0134 69 27	27	30.5	67	43	16	0.108

Polymer collar

Self-fastening NBR hose is selected by nominal diameter; for example:

Barb Connector	O.D. (Tube)	Ø DN (Tube)	Self-Fastening NBR hose
0132 10 56	10	1/4	10..H 56...



Brass Adaptors

0122 Barb Connector for Hose

Brass

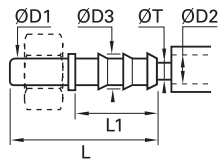

ØD1	ØD2		ØD3	L	L1	ØT min	Kg
4	4	0122 04 04	6	37.5	22.5	3	0.004
5	4	0122 05 04	6	37.5	22.5	3	0.003
6	4	0122 06 04	6	37.5	22.5	3	0.005
	7	0122 06 07	9	37.5	22.5	6	0.007
8	6	0122 08 06	8	40	22.5	5	0.007
	7	0122 08 07	9	40	22.5	6	0.008
	10	0122 08 10	12.5	40	22.5	9	0.012
10	7	0122 10 07	9	43	22.5	6	0.010
	10	0122 10 10	12.5	43	22.5	9	0.014
12	10	0122 12 10	12.5	43	22.5	9	0.013
	13	0122 12 13	15	50	29.5	12	0.018
14	13	0122 14 13	15	52	29.5	12	0.019
	16	0122 14 16	18.5	60.5	38	15	0.031
15	13	0122 15 13	15	52	29.5	12	0.020
	16	0122 15 16	18.5	60.5	38	15	0.032
16	13	0122 16 13	15	53.5	29.5	12	0.021
	16	0122 16 16	18.5	62	38	15	0.032
18	16	0122 18 16	18.5	62	38	15	0.032
	19	0122 18 19	21.5	62	38	18	0.040
20	16	0122 20 16	18.5	64	38	15	0.034
	19	0122 20 19	21.5	64	38	18	0.039
22	19	0122 22 19	21.5	64	38	18	0.041
25	19	0122 25 19	21.5	70	38	18	0.048
	25	0122 25 25	27.5	70	38	24	0.054
28	25	0122 28 25	27.5	70	38	24	0.087

0165 Barb Connector for Flexible Tubing

Brass

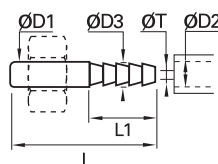

ØD1	ØD2		ØD3	L	L1	ØT min	Kg
4	4	0165 04 06	4.3	30	15	2	0.002
5	4	0165 05 06	4.3	30	15	2	0.003
6	4	0165 06 06	4.3	30	15	2	0.003
	6	0165 06 08	6.4	30	15	4	0.004
8	6	0165 06 10	8.4	30	15	4	0.004
	6	0165 08 08	6.4	32.5	15	4	0.005
8	8	0165 08 10	8.4	32.5	15	6	0.006
	10	0165 08 12	10.7	37.5	20	8	0.009
	8	0165 10 10	8.4	35.5	15	6	0.008
10	10	0165 10 12	10.7	40.5	20	8	0.010
	12	0165 10 14	12.7	40.5	20	8	0.012
12	10	0165 12 12	10.7	40.5	20	8	0.011
	12	0165 12 14	12.7	40.5	20	10	0.012
14	12	0165 14 14	12.7	42.5	20	10	0.015
15	13	0165 15 16	13.7	42.5	20	11	0.015
16	13	0165 16 16	13.7	44	20	11	0.018

Assembly: Barb Connectors

Our barb connectors 0122 and 0165 are designed to be used with different types of hose. They are secured using the nut and olive provided with the fitting.

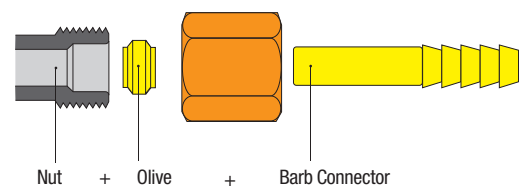

Brass Adaptors

0126 Plug for Compression Fitting

Brass

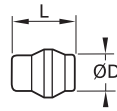

ØD		L	Kg
4	0126 04 00	10	0.002
5	0126 05 00	10	0.003
6	0126 06 00	10	0.003
8	0126 08 00	11.5	0.006
10	0126 10 00	13	0.010
12	0126 12 00	13	0.014
14	0126 14 00	13.5	0.020
15	0126 15 00	13.5	0.022
16	0126 16 00	16	0.030
18	0126 18 00	16	0.038
20	0126 20 00	16	0.045
22	0126 22 00	18	0.003
28	0126 28 00	19.5	0.108

The plug is used to blank off an outlet in a compression fitting, replacing the olive.

When an open outlet is required, simply dismantle and replace the plug with the tube olive, reusing the nut. The plug is also reusable.

0125 Tube End Plug for Compression Fitting

Brass

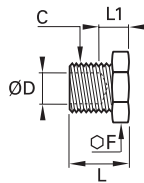

ØD	C		F	L	L1	Kg
4	M8x1	0125 04 00	10	12	8	0.006
6	M10x1	0125 06 00	11	13.5	9.5	0.008
8	M12x1	0125 08 00	14	14	9	0.012
10	M16x1.5	0125 10 00	17	18	11	0.025
12	M18x1.5	0125 12 00	19	18	11	0.030
14	M20x1.5	0125 14 00	22	19	11	0.041

This plug enables unused tubes to be blanked off.

The male thread on the plug has the same pitch as the female thread on the sleeve nut of a standard Parker Legris fitting.

Therefore the plug screwed into the sleeve nut blanks off the tube.

To reopen the passage, simply unscrew the plug and fit the required coupler.

No further treatment of the tube is required.

0220 Hex Head Plug, Male BSPP and Metric Thread

Brass, technical polymer

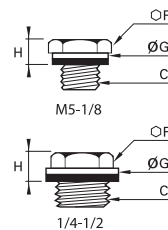

C		F	G	H1	Kg
M5x0.8	0220 19 00	8	8	5	0.002
G1/8	0220 10 00	14	14	7.5	0.011
G1/4	0220 13 00	17	17	7.5	0.020
G3/8	0220 17 00	17	22	8.5	0.024
G1/2	0220 21 00	22	27	10	0.041

Thread with pre-assembled sealing washer

M5: with screwdriver slot for tightening

Maximum allowable working pressure = 20 bar

Part number with suffix 99, maximum allowable working pressure = 250 bar, example: 0220 19 00 99

Conforms to BNA 229 (with the exception of M5 model), BSPP thread, ISO ISO 228-1,

Parallel metric thread, ISO NFE 03-054

0220..39 Hex Head Plug with Bi-Material Seal, Male BSPP Thread

Brass, zinc-plated steel with NBR seal

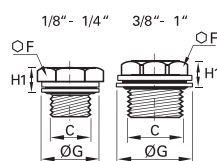

C		F	G	H	Kg
G1/8	0220 10 00 39	14	14	6.5	0.012
G1/4	0220 13 00 39	17	17	6.5	0.020
G3/8	0220 17 00 39	17	22	8	0.025
G1/2	0220 21 00 39	22	26	9	0.043
G3/4	0220 27 00 39	22	32	10	0.060
G1	0220 34 00 39	27	39.5	10.5	0.089

Plug with bi-material seal

Bi-material washers part number 0139 can be found in chapter 9.

Brass Adaptors

0120

Stud Standpipe, Male BSPT Thread

Brass

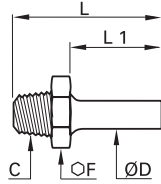

ØD	C		F	L	L1	Kg
4	R1/8	0120 04 10	11	25.5	14	0.007
5	R1/8	0120 05 10	11	26	14.5	0.007
6	R1/8	0120 06 10	11	26.5	15	0.008
	R1/4	0120 06 13	14	31	15	0.015
8	R1/8	0120 08 10	11	28.5	17	0.009
	R1/4	0120 08 13	14	33	17	0.016
	R3/8	0120 08 17	17	33.5	17	0.020
10	R1/4	0120 10 13	14	36	20	0.018
	R3/8	0120 10 17	17	36.5	20	0.022
	R1/2	0120 10 21	22	41	20	0.040
12	R1/4	0120 12 13	14	36	20	0.018
	R3/8	0120 12 17	17	36.5	20	0.022
14	R1/2	0120 12 21	22	41	20	0.040
	R3/8	0120 14 17	17	38	21.5	0.023
15	R1/2	0120 14 21	22	42.5	21.5	0.041
	R3/8	0120 15 17	17	38	21.5	0.023
16	R1/2	0120 15 21	22	42.5	21.5	0.041
	R3/8	0120 16 17	17	39.5	23	0.024
18	R1/2	0120 16 21	22	44	23	0.042
	R3/4	0120 18 21	22	44.5	23.5	0.042
20	R3/4	0120 18 27	27	47.5	23.5	0.071
	R3/4	0120 20 27	27	49	25	0.070
22	R3/4	0120 22 27	27	48.5	25.5	0.067
	R1	0120 22 34	36	52.5	25.5	0.117
25	R1	0120 25 34	36	57	30	0.118
28	R1	0120 28 34	36	57	30	0.140

0112

Sleeve Nut for Compression Fitting, Male Metric Thread

Brass

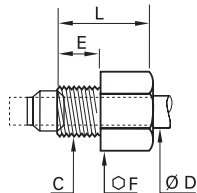

ØD	C		E	F	L	Kg
4	M8x1	0112 04 00	7	10	13	0.005
5	M10x1	0112 05 00	7.5	11	13.5	0.007
6	M10x1	0112 06 00	7.5	11	13.5	0.006
8	M12x1	0112 08 00	8	13	15	0.009
10	M16x1.5	0112 10 00	11	17	18	0.018
12	M18x1.5	0112 12 00	11	19	18	0.021
14	M20x1.5	0112 14 00	11	22	18	0.026

This product was designed to allow the tube to be fitted directly into the tapped port in a body using a standard Parker Legris olive.

For the corresponding drawings (cavity for Parker Legris olive), please consult us.

Brass Adaptors

0128..39 Stud Standpipe with Bi-Material Seal, Male BSPP Thread

Brass, zinc-plated steel with NBR seal

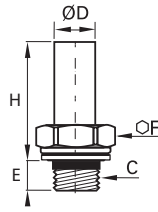

ØD	C		E	F	H	Kg
4	G1/8	0128 04 10 39	7.5	13	20	0.009
	G1/4	0128 04 13 39	9	17	22	0.015
6	G1/8	0128 06 10 39	7.5	13	21	0.010
	G1/4	0128 06 13 39	9	17	23	0.016
8	G1/8	0128 08 10 39	7.5	13	23	0.011
	G1/4	0128 08 13 39	9	17	25	0.017
	G3/8	0128 08 17 39	12	22	26	0.032
10	G1/4	0128 10 13 39	9	17	28	0.018
	G3/8	0128 10 17 39	12	22	29	0.034
14	G1/2	0128 10 21 39	27	27	30	0.049
	G3/8	0128 14 17 39	12	22	30.5	0.035
18	G1/2	0128 14 21 39	27	27	31.5	0.049
	G3/4	0128 18 21 39	27	27	33.5	0.051
22	G3/4	0128 18 27 39	14	32	34.5	0.084
	G1	0128 22 27 39	14	32	36.5	0.082
28	G1	0128 22 34 39	16.5	41	38	0.123
	G1	0128 28 34 39	16.5	41	42.5	0.147

With bi-material seal. Bi-material washers part number 0139 can be found in Chapter 9.

0151..39 Straight Male Orientable Adaptor, with Bi-Material Seal, Male BSPP Thread

Brass, NBR, zinc-plated steel with NBR seal

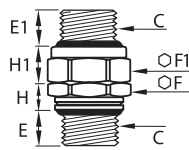

C		E	E1	F	F1	H	H1	Kg
G1/8	0151 10 10 39	5.5	7	13	14	6	6.5	0.017
G1/4	0151 13 13 39	7	8.5	17	19	6.5	9	0.036
G3/8	0151 17 17 39	9.5	9.5	22	22	9	9	0.056
G1/2	0151 21 21 39	10.5	10.5	27	27	10	10	0.083
G3/4	0151 27 27 39	11.5	11.5	32	32	11	10	0.121
G1	0151 34 34 39	13	13.5	41	41	12.5	10.5	0.217

With bi-material seal.

Bi-material washers part number 0139 can be found in Chapter 9.

0168..39 Reducer, with Bi-Material Seal, Male BSPP Thread/Female BSPP and Metric Thread

Brass, zinc-plated steel with NBR seal

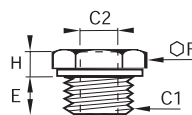

C1	C2		E	F	H	Kg
G1/8	M5x0.8	0168 10 19 39	8	14	4.5	0.009
	M5x0.8	0168 13 19 39	8	17	5	0.018
G1/4	G1/8	0168 13 10 39	8	17	5	0.012
	G1/8	0168 17 10 39	10	19	5	0.020
G3/8	G1/4	0168 17 13 39	10	19	5	0.013
	G1/8	0168 21 10 39	12	24	7.5	0.052
G1/2	G1/4	0168 21 13 39	12	24	7.5	0.044
	G3/8	0168 21 17 39	12	24	7.5	0.031
G3/4	G1/4	0168 27 13 39	12	32	9.5	0.100
	G3/8	0168 27 17 39	12	32	9.5	0.086
G1/2	0168 27 21 39	12	32	9.5	0.065	

With bi-material seal.

Bi-material washers part number 0139 can be found in Chapter 9.

Brass Adaptors

0127

Brass Tube Support for Polymer Tubing

Brass

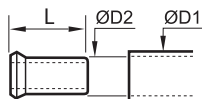

	ØD1	ØD2		L	Kg
4	2		0127 04 00	11	0.001
	2.7		0127 04 27	11	0.001
5	3		0127 05 03	11	0.001
	3.3		0127 05 00	11.5	0.009
6	4		0127 06 00	11.5	0.001
	5.5		0127 08 55	14	0.001
8	6		0127 08 00	14	0.001
	7		0127 10 07	18	0.001
10	7.5		0127 10 75	18	0.001
	8		0127 10 00	18	0.002
12	8		0127 12 08	18	0.002
	9		0127 12 09	18	0.002
14	10		0127 12 00	18	0.001
	11		0127 14 11	18	0.002
15	12		0127 14 00	18	0.002
	12		0127 15 12	18	0.002
16	13		0127 16 13	18	0.003
	14		0127 18 14	19.5	0.003
20	15		0127 20 15	20.5	0.003
	16		0127 22 16	21	0.004
25	19		0127 25 19	25	0.007

This tube support guarantees good gripping, at high temperatures and pressures, by preventing collapsing of the tube.

Stainless Steel Compression Fitting Range

Stainless Steel Fittings

Stud Fittings

1805
BSPT
Page 5-34

1805
NPT
Page 5-34

1814
BSPP
Page 5-34

1809
BSPT
Page 5-35

1809
NPT
Page 5-35

1820
BSPT
Page 5-35

1820
NPT
Page 5-35



Tube-to-Tube Fittings

1806
Page 5-36

1816
Page 5-36

1802
Page 5-36

1804
Page 5-36



Complementary Fittings

1866
Page 5-39

1824
Page 5-39

1810
Page 5-39



Accessories

1822
Page 5-39

1827
Page 5-39



Stainless Steel Compression Fittings

Manufactured in 316L stainless steel, these fittings combine all the advantages of the "universal" compression fitting with **excellent resistance** to environmental conditions and **corrosive fluids**. They are pressure and temperature-resistant and are able to withstand strong vibration and water hammer.

Product Advantages

For Use in Many Environments

Manufactured in 316L stainless steel
 Suitable for all environments and fluids
 Resistant to water hammer and vibration
 Excellent sealing and retention of the tube
 Suitable for pneumatic and medium pressure hydraulic applications
 Metallic sealing guarantees maximum service life

Many Tube Options

Possibility of easily connecting different tube materials and diameters to the same fitting body
 No tube support required for rigid and semi-rigid polyamide tubing below 12 mm



Food Process
 Fluid Transmission
 Pneumatics
 Automotive Process
 Petrochemical
 Chemical
 Offshore Oil & Gas

Applications

Technical Characteristics

Compatible Fluids	Many fluids					
Working Pressure	Vacuum to 400 bar (80 bar in corrosive environments)					
Working Temperature	-60°C to +250°C with metal tubing					

Tightening Torques	DN	6	8	10	12	16
	daN.m	2	3	4	6.5	9.5

Reliable performance is dependent upon the type of fluid conveyed and tubing being used. Guaranteed for use with a vacuum of 755 mm Hg (99% vacuum). Thread sealing must be guaranteed by user.

Component Materials

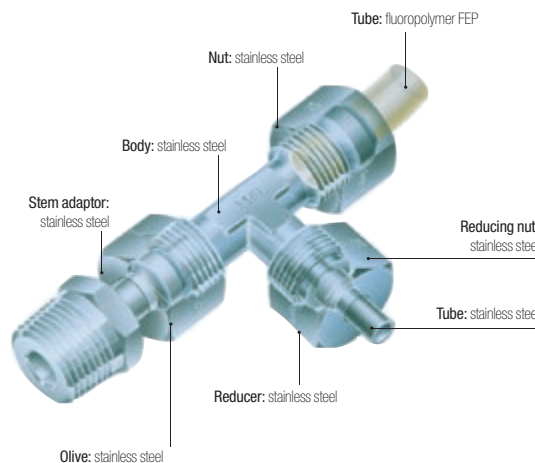

Silicone-free

Maximum Bore Diameters

The table below shows the recommended compatibility of tube size, BSPP male thread and maximum bore.

Tube O.D	BSPP Thread	Max. Bore
6	G1/8	4
6-8-10	G1/4	7
10-12	G3/8	11
16	G1/2	14

Tube Length for Assembly

Minimum length of tube (L) between 2 fittings.

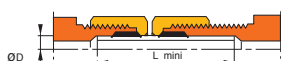

ØD	L mm	ØD	L mm
4	26.5	10	39
6	26	12	39
8	32	16	46.5

Regulations

DI: 2002/95/EC (RoHS), 2011/65/EC
 DI: 97/23/EC (PED)
 RG: 1935/2004
 RG: 1907/2006 (REACH)
 DI: 94/09/EC (ATEX)
 FDA: 21 CFR 177.1550
 NACE MR0175: compatible materials
 ISO 15156-1/-2/-3: compatible materials

Stainless Steel Compression Fittings

Installation

Fitting

The fitting comprises three parts (body/olive/nut). For assembly procedure, please see Brass Compression Fitting page.

Diagram: Assembled Fitting

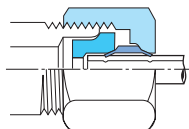

A very slight distortion of the tube appears; this shows the fitting has been correctly tightened.

Orientable Elbow Assembly

Elbow
1802

Adaptor
1820

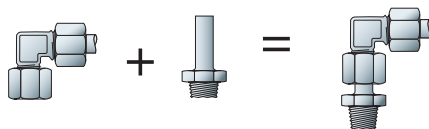

Customised Fittings

If our standard range does not meet your needs, Parker Legris can develop customised solutions for your applications.

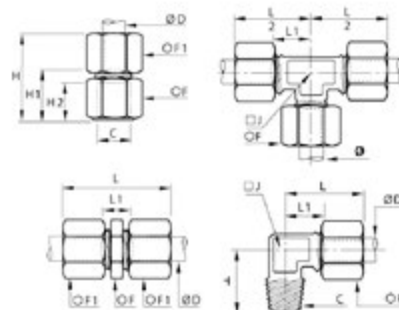

Technical Characteristics

The use of Parker Legris stainless steel compression fittings is dependant on the tube material. Tables of recommended working pressure for the different tubes are shown below.

Recommended Tube Type

Semi-rigid polyamide or fluoropolymer tube

Stainless steel tube

"Thin Wall" cold-drawn seamless, annealed and passivated: wall thickness tolerance ± 0.1 mm. For use with "thin wall" stainless steel tube from 6 mm to 16 mm O.D., maximum wall thickness 1 mm.

Recommended Tube/Fitting Assembly Configurations

Assembled using Parker Legris olive and nut in stainless steel, with a tube support.

Stainless steel tube

Stainless steel tube: in cold-rolled straight lengths
Coiled annealed stainless tube: reduces working pressure by 35%; do not use if there is vibration.

Semi-Rigid Polyamide Tube

Maximum Working Pressure (bar)

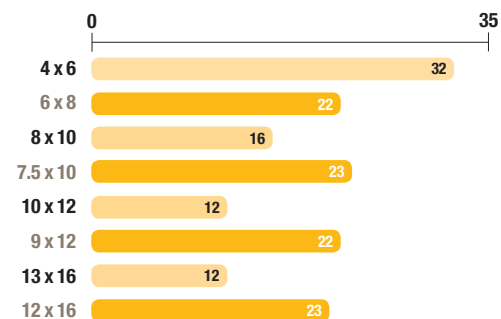

Stainless Steel Tube

Maximum Working Pressure (bar)

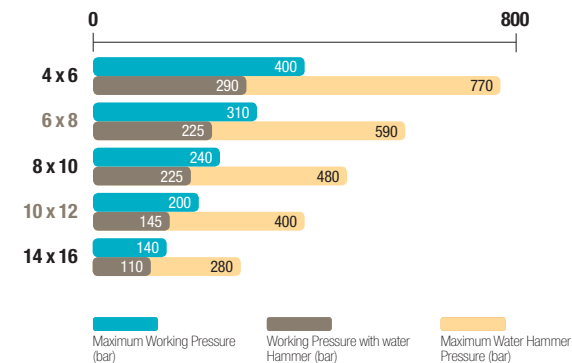

Working Pressure Coefficients for Semi-Rigid Tubing

Temperature °C	-40°C / -15°C	-15°C / +30°C	+30°C / +50°C	+50°C / +70°C	+70°C / +100°C
Factor	1.8	1	0.68	0.55	0.31

The above recommendations are given in good faith. However, since each application is different, it is advisable to undertake tests in actual working conditions.

Stainless Steel Compression Fittings

1805 Stud Fitting, Male BSPT Thread

Stainless steel 316L

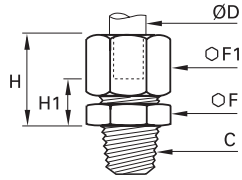

ØD	C		F	F1	H _{max}	H1	Kg
6	R1/8	1805 06 10	12	13	19.5	7.5	0.017
	R1/4	1805 06 13	14	13	19.5	7.5	0.024
8	R1/8	1805 08 10	13	14	21	7	0.019
	R1/4	1805 08 13	14	14	21	7	0.025
10	R1/4	1805 10 13	17	19	25.5	9	0.043
	R3/8	1805 10 17	17	19	25.5	9	0.049
	R1/2	1805 10 21	22	19	26.5	10	0.077
12	R1/4	1805 12 13	19	22	26	9	0.054
	R3/8	1805 12 17	19	22	26	9	0.057
	R1/2	1805 12 21	22	22	27	10	0.081
16	R3/8	1805 16 17	24	27	28.5	9.5	0.085
	R1/2	1805 16 21	24	27	28.5	9.5	0.095

1805 Stud Fitting, Male NPT Thread

Stainless steel 316L

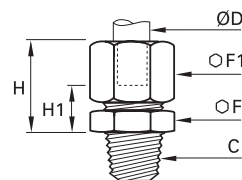

ØD	C		F	F1	H _{max}	H1	Kg
6	NPT1/8	1805 06 11	12	13	19.5	7.5	0.018
	NPT1/4	1805 06 14	14	13	19.5	7.5	0.027
	NPT3/8	1805 06 18	19	13	20.5	8.5	0.033
8	NPT1/2	1805 06 22	22	13	21.5	9.5	0.049
	NPT1/8	1805 08 11	13	14	21	7	0.020
	NPT1/4	1805 08 14	14	14	21	7	0.027
10	NPT1/4	1805 10 14	17	19	25.5	9	0.046
	NPT3/8	1805 10 18	19	19	25.5	9	0.055
	NPT1/2	1805 10 22	22	19	26.5	10	0.081
12	NPT1/4	1805 12 14	19	22	26	9	0.056
	NPT3/8	1805 12 18	19	22	26	9	0.060
	NPT1/2	1805 12 22	22	22	27	10	0.087
16	NPT3/8	1805 16 18	24	27	28.5	9.5	0.087
	NPT1/2	1805 16 22	24	27	28.5	9.5	0.097

1814 Stud Fitting, Female BSPP Thread

Stainless steel 316L

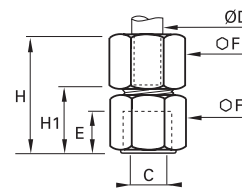

ØD	C		E	F	F1	H _{max}	H1	Kg
6	G1/8	1814 06 10	7.5	14	13	29	17	0.023
	G1/4	1814 06 13	11	17	13	29	21	0.032
8	G1/4	1814 08 13	11	17	14	34.5	20.5	0.033
	G3/8	1814 10 17	11.5	22	19	38.5	22	0.064
10	G1/2	1814 10 21	15	27	19	43	26.5	0.094
	G3/8	1814 12 17	11.5	22	22	39	22	0.073
12	G1/2	1814 12 21	15	27	22	43.5	26.5	0.103
	G1/2	1814 16 21	15	27	27	45	26	0.121

Stainless Steel Compression Fittings

1809 Stud Elbow, Male BSPT Thread

Stainless steel 316L

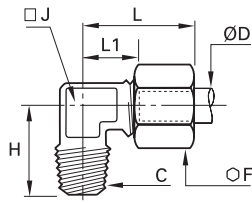

ØD	C		F	H	J	L _{max}	L1	Kg
6	R1/8	1809 06 10	13	18	8	25.5	13.5	0.020
	R1/4	1809 06 13	13	23	10	25.5	13.5	0.029
8	R1/8	1809 08 10	14	20.5	10	28.5	14.5	0.026
	R1/4	1809 08 13	14	23	10	28.5	14.5	0.030
10	R1/4	1809 10 13	19	25	12	32.5	16	0.050
	R3/8	1809 10 17	19	25.5	12	32.5	16	0.058
12	R1/2	1809 10 21	19	32	18	36.5	20	0.093
	R1/4	1809 12 13	22	26	14	34	17	0.067
16	R3/8	1809 12 17	22	27	14	34	17	0.069
	R1/2	1809 12 21	22	32	18	37	20	0.100
16	R3/8	1809 16 17	27	28.5	18	39.5	21	0.108
	R1/2	1809 16 21	27	31.5	18	39.5	21	0.115

1809 Stud Elbow, Male NPT Thread

Stainless steel 316L

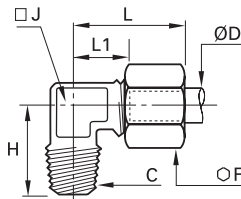

ØD	C		F	H	J	L _{max}	L1	Kg
6	NPT1/8	1809 06 11	13	19.5	8	25.5	13.5	0.021
	NPT1/4	1809 06 14	13	25.5	10	25.5	13.5	0.032
	NPT3/8	1809 06 18	13	28	12	27	15	0.046
	NPT1/2	1809 06 22	13	34	12	29	17	0.071
8	NPT1/8	1809 08 11	14	22	10	28.5	14.5	0.027
	NPT1/4	1809 08 14	14	25.5	10	28.5	14.5	0.033
10	NPT1/4	1809 10 14	19	27.5	12	32.5	16	0.052
	NPT3/8	1809 10 18	19	28	12	32.5	16	0.062
	NPT1/2	1809 10 22	19	35	18	36.5	20	0.096
12	NPT1/4	1809 12 14	22	28.5	14	34	17	0.068
	NPT3/8	1809 12 18	22	29.5	14	34	17	0.073
	NPT1/2	1809 12 22	22	35	18	37	20	0.104
16	NPT3/8	1809 16 18	27	31	18	39.5	21	0.110
	NPT1/2	1809 16 22	27	34.5	18	39.5	21	0.116

1820 Stud Standpipe, Male BSPT Thread

Stainless steel 316L

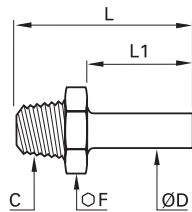

ØD	C		F	L	L1	Kg
6	R1/8	1820 06 10	12	26.5	15	0.009
	R1/4	1820 06 13	14	31	15	0.018
8	R1/8	1820 08 10	12	28.5	17	0.008
	R1/4	1820 08 13	14	33	17	0.017
10	R1/4	1820 10 13	14	36	20	0.017
	R3/8	1820 10 17	17	36.5	20	0.025
	R1/2	1820 10 21	22	41	20	0.053
12	R1/4	1820 12 13	14	36	20	0.016
	R3/8	1820 12 17	17	36.5	20	0.022
16	R1/2	1820 12 21	22	41	20	0.049
	R3/8	1820 16 17	17	39.5	23	0.022
	R1/2	1820 16 21	22	44	23	0.039

1820 Stud Standpipe, Male NPT Thread

Stainless steel 316L

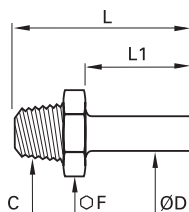

ØD	C		F	L	L1	Kg
6	NPT1/8	1820 06 11	12	26.5	15	0.010
	NPT1/4	1820 06 14	14	31	15	0.019
8	NPT1/8	1820 08 11	12	28.5	17	0.009
	NPT1/4	1820 08 14	14	33	17	0.019
10	NPT1/4	1820 10 14	14	36	20	0.018
	NPT3/8	1820 10 18	19	36.5	20	0.032
	NPT1/2	1820 10 22	22	41	20	0.060
12	NPT1/4	1820 12 14	14	36	20	0.019
	NPT3/8	1820 12 18	19	36.5	20	0.028
	NPT1/2	1820 12 22	22	41	20	0.053
16	NPT3/8	1820 16 18	19	39.5	23	0.027
	NPT1/2	1820 16 22	22	44	23	0.042

Stainless Steel Compression Fittings

Stainless Steel Compression Fittings

1806 Equal Tube-to-Tube Connector

Stainless steel 316L

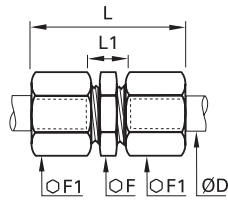

ØD		F	F1	L _{max}	L1	Kg
6	1806 06 00	12	13	34.5	11	0.024
8	1806 08 00	13	14	38.5	10	0.029
10	1806 10 00	17	19	46	13	0.066
12	1806 12 00	19	22	47	13	0.085
16	1806 16 00	24	27	51	13	0.136

1816 Equal Bulkhead Connector

Stainless steel 316L

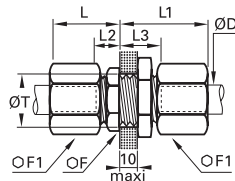

ØD		F	F1	L _{max}	L1 _{max}	L2	L3	ØT _{min}	Kg
6	1816 06 00	13	13	28	19	7.5	17	10.5	0.035
8	1816 08 00	14	14	29	20	7	17	12.5	0.042
10	1816 10 00	19	19	33	25	9	19	16.5	0.093
12	1816 12 00	22	22	33	25	9	19	18.5	0.113
16	1816 16 00	27	27	36	28	9.5	19.5	22.5	0.179

1802 Equal Elbow

Stainless steel 316L

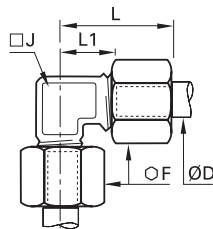

ØD		F	J	L _{max}	L1	Kg
6	1802 06 00	13	8	25.5	13.5	0.027
8	1802 08 00	14	10	28.5	14.5	0.035
10	1802 10 00	19	12	32.5	16	0.069
12	1802 12 00	22	14	34	17	0.093
16	1802 16 00	27	18	39.5	21	0.152

1804 Equal Tee

Stainless steel 316L

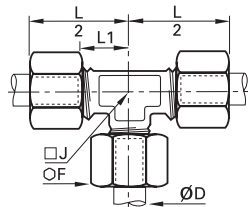

ØD		F	J	L1	L/2	Kg
6	1804 06 00	13	8	13.5	25.5	0.039
8	1804 08 00	14	10	14.5	28.5	0.049
10	1804 10 00	19	12	16	32.5	0.102
12	1804 12 00	22	14	17	34	0.132
16	1804 16 00	27	18	21	39.5	0.215



Stainless Steel
Compression Fittings

Compression Fittings

Complementary Stainless Steel Fittings

Reducers, Olives and Nuts

This innovative reducer system, using a full range of nuts and olives, enables **different diameters** of stainless steel, fluoropolymer or polymer tubes to be fitted onto **a single Parker Legris compression fitting**.

Product Advantages

Efficient Solution

Reduces envelope dimensions
Quick and easy to assemble, whatever the diameters and tube material
Improved stock management
Silicone-free

Multiple Combinations

A single connector for up to 3 different tube materials and sizes.
Example:

- Advanced PE tubing 6 mm O.D.
- stainless steel tubing 8 mm O.D.
- fluoropolymer tubing 12 mm O.D. or braided PVC hose 10 mm I.D.

 A full range of olives and nuts to optimise all assembly operations



Food Process
Fluid Transmission
Pneumatics
Automotive Process
Petrochemical
Cooling & Heating
Chemical
Offshore Oil & Gas

Applications

Reducer Assembly Procedure

Operation	Assembly Sequence	Assembled Fitting
<p>1 Assemble the reducer Place the reducer in the fitting body.</p>	<p>1</p>	
<p>2 Assemble the nut and olive Place the nut and then the olive onto the tube.</p>	<p>2</p>	
<p>3 Assemble the nut Push the tube into the fitting until it bottoms on the reducer. Tighten the nut to the recommended torque (see opposite page).</p>	<p>3</p>	

Assembly: Barb Connectors

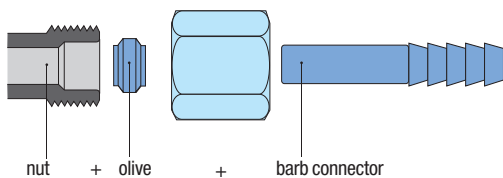

Regulations

DI: 2002/95/EC (RoHS), 2011/65/EC
DI: 97/23/EC (PED)
RG: 1935/2004
RG: 1907/2006 (REACH)
DI: 94/09/EC (ATEX)
FDA: 21 CFR 177.1550
NACE MR0175: compatible materials
ISO 15156-1/-2/-3: compatible materials

Our barb connector 1822 is designed to be also used with different types of hose. It is secured using the nut and olive provided with the fitting.

Stainless Steel Compression Fittings

1866 3-Piece Reducer

Stainless steel 316L

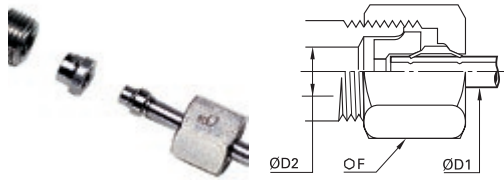

ØD1	ØD2		F	Kg
6	8	1866 06 08	14	0.011
	10	1866 06 10	19	0.027
	12	1866 06 12	22	0.040
8	10	1866 08 10	19	0.025
	12	1866 08 12	22	0.037
10	12	1866 10 12	22	0.034
	16	1866 10 16	27	0.065
12	16	1866 12 16	27	0.061

1824 Stainless Steel Olive

Stainless steel 316L



ØD		Kg
6	1824 06 00	0.001
8	1824 08 00	0.001
10	1824 10 00	0.003
12	1824 12 00	0.004
16	1824 16 00	0.005

1810 Stainless Steel Nut

Stainless steel 316L

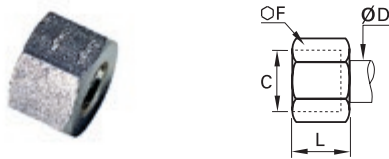

ØD	C		F	L	Kg
6	M10x1	1810 06 00	13	11	0.007
8	M12x1	1810 08 00	14	13	0.008
10	M16x1.5	1810 10 00	19	15	0.017
12	M18x1.5	1810 12 00	22	15	0.024
16	M22x1.5	1810 16 00	27	17	0.041

1822 Barb Adaptor for Hose

Stainless steel 316L

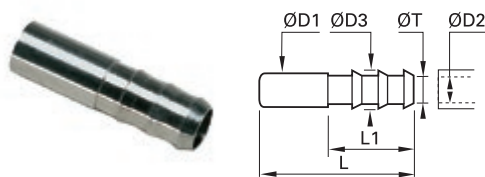

ØD1	ØD2		ØD3	L	L1	ØT min	Kg
6	7	1822 06 07	9	37.5	22.5	6	0.006
	6	1822 08 06	8	40	22.5	5	0.007
8	7	1822 08 07	9	40	22.5	6	0.007
	10	1822 08 10	12.5	40	22.5	9	0.011
10	7	1822 10 07	9	43	22.5	6	0.009
	10	1822 10 10	12.5	43	22.5	9	0.013
12	10	1822 12 10	12.2	43	22.5	9	0.012
	13	1822 12 13	15	50	29.5	13	0.016

1827 Stainless Steel Tube Support for Fluoropolymer Tubing

Stainless steel 316L

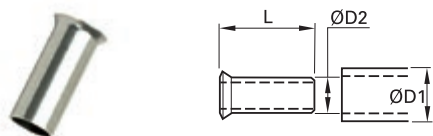

ØD1	ØD2		L	Kg
6	4	1827 06 00	11.5	0.001
8	6	1827 08 00	14	0.001
10	8	1827 10 00	18	0.001
12	9	1827 12 09	18	0.001
	10	1827 12 00	18	0.001
16	14	1827 16 00	18	0.002

This tube support is necessary when using fluoropolymer tubing at all temperatures compatible with the fitting/tubing assembly.

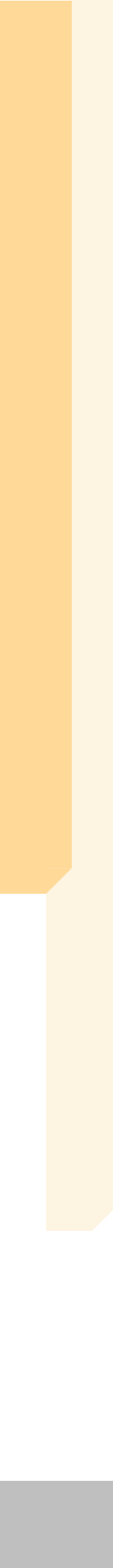

PL Nickel-Plated Brass Spigot Fitting Range

Stud Fittings

Straights

F3BPL BSPT Page 5-43
F3BPL-1 BSPT Page 5-43
F4BPL BSPP Page 5-43
F8BPL Metric Page 5-43
F8BPL-1 Metric Page 5-43



Elbows

C3BPL BSPT Page 5-44
C3BPL-1 BSPT Page 5-44
C4BPL BSPP Page 5-44
C8BPL Metric Page 5-44



Tees

R3BPL BSPT Page 5-45
S3BPL BSPT Page 5-45



Banjo Fitting

Banjo Fitting

COR4BPL BSPP Page 5-45



Tube-to-Tube Fittings

Straights

HBPL Union Page 5-46
HBPL-1 Union Page 5-46



Tees

JBPL Union Page 5-46
JBPL-1 Union Page 5-46



Bulkhead Connectors

WBPL Page 5-47
WBPL-1 Page 5-47



Complementary Fittings

BPLM Nut Page 5-47
BPLM-M Nut Page 5-47
0164 NPT/BSPP Page 5-47



PL Nickel-Plated Brass Spigot Fittings

This range of Parker Legris has a sealing system which guarantees **excellent sealing and full flow**. PL fittings for flexible tubing are **fully re-usable**. They provide excellent compatibility with a wide variety of fluids.

Product Advantages

Rapid Assembly

Nut design allows for easy tightening
Quick to assemble and disassemble
Compatible with flexible and semi-rigid tubes (polyurethane, polyamide, polyethylene, fluoropolymers, etc.)
Mechanical stop on the body to prevent overtightening

Performance

Reliable direct sealing system without the use of a seal or olive
Low pressure
Nickel-plated for increased corrosion resistance



Food Process
Painting
Pneumatic Systems
Chemical
Welding
Laboratories
Railway

Applications

Technical Characteristics

Compatible Fluids	Compressed air Other fluids: contact us
Working Pressure	Vacuum to 18 bar with BPLM-M nut Vacuum to 40 bar with BPLM nut
Working Temperature	-40°C to +100°C

Tightening Torque (Nm)	M5x0.8	M6x1	1/8	1/4	3/8	1/2
BSPT Thread			8	12	14	16
BSPP Thread with "O" ring			1.2	1.5	2.5	3.5
BSPP Thread with metal sleeve			5	8	10	12
Metric Thread	0.8	0.8				

Reliable performance is dependent upon the type of fluid conveyed, component materials and tubing being used.
Guaranteed for use with a vacuum of 755 mm Hg (99% vacuum).
For use with fire-proof tubing: please consult us.

Installation

Cutting the Tube



Cut the polymer tube square.

Preparing the Connection



Slide the nut onto the tube.

Connecting the Tube



Push the tube home into the body of the fitting.

Final Assembly



Tighten the nut by hand (in the case of soft tubing) or using a spanner (for semi-rigid tubing) until it comes into contact with the end stop.

Component Materials

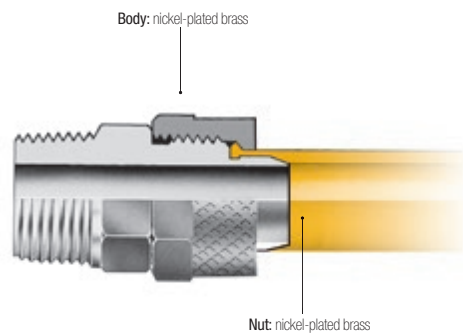



Silicone-free

Stud Fittings

F3BPL Stud Fitting, Male BSPT Thread

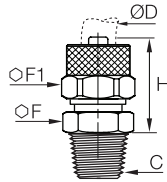
Nickel-plated brass





ØD	C		F	F1	H	Kg	
2.7x4	R1/8		F3BPL2.7/4-1/8	12	8	24	0.009
4x6	R1/8		F3BPL4/6-1/8	12	12	27.5	0.016
	R1/4		F3BPL4/6-1/4	14	12	31	0.025
6x8	R1/8		F3BPL6/8-1/8	12	14	27.5	0.019
	R1/4		F3BPL6/8-1/4	14	14	31	0.026
8x10	R3/8		F3BPL6/8-3/8	17	14	31.5	0.030
	R1/4		F3BPL8/10-1/4	14	16	32.5	0.031
10x12	R3/8		F3BPL8/10-3/8	17	16	33	0.043
	R3/8		F3BPL10/12-3/8	17	18	34.5	0.036

Compatible with BPLM-M nut only

F3BPL-1 Stud Fitting, Male BSPT Thread

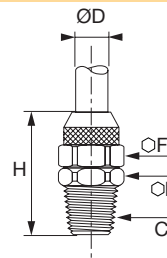
Nickel-plated brass





ØD	C		F	F1	H	Kg	
7.5x10	R1/4		F3BPL7.5/10-1/4	14	16	27.5	0.031
	R3/8		F3BPL7.5/10-3/8	17	16	28.5	0.037
11x14	R3/8		F3BPL11/14-3/8	19	22	32.5	0.058

Compatible with BPLM nut only
Maximum working pressure: 40 bar

F4BPL Stud Fitting, Male BSPP Thread

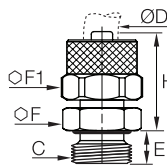
Nickel-plated brass, NBR



ØD	C		E	F	F1	H	Kg	
4x6	G1/8		F4BPL4/6-1/8	6	13	12	25.5	0.031
6x8	G1/4		F4BPL6/8-1/4	8	16	14	28	0.033

Compatible with BPLM-M nut only

F8BPL Stud Fitting, Male Metric Thread

Nickel-plated brass, NBR

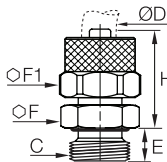

ØD	C		E	F	F1	H	Kg	
6x8	M10x1		F8BPL6/8M10	7	14	13	28	0.025

Compatible with BPLM-M nut only

F8BPL-1 Stud Fitting, Male Metric Thread

Nickel-plated brass, copper

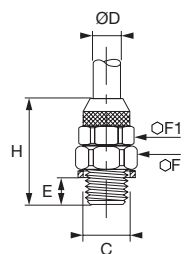

ØD	C		E	F	F1	H	Kg	
6x8	M12x1.25		F8BPL6/8M12	8	17	14	28	0.028

Compatible with BPLM nut only
Maximum working pressure: 40 bar
These fittings are supplied with a copper seal.

Stud Fittings

C3BPL Stud Elbow, Male BSPT Thread

Nickel-plated brass

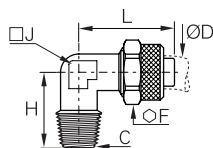

ØD	C		F	H	J	L	Kg
2.7x4	R1/8	C3BPL2.7/4-1/8	8	17	8	19.5	0.018
	R1/8	C3BPL4/6-1/8	12	17	8	22.5	0.022
4x6	R1/4	C3BPL4/6-1/4	12	20	10	22.5	0.031
	R1/8	C3BPL6/8-1/8	14	17	10	22.5	0.029
6x8	R1/4	C3BPL6/8-1/4	14	20	10	22.5	0.031
	R3/8	C3BPL6/8-3/8	14	22.5	11	24	0.064
8x10	R1/4	C3BPL8/10-1/4	16	21.5	11	25.5	0.057
	R3/8	C3BPL8/10-3/8	16	22.5	11	25.5	0.057
10x12	R3/8	C3BPL10/12-3/8	18	24.5	14	30	0.060

Compatible with BPLM nut only

C3BPL-1 Stud Elbow, Male BSPT Thread

Nickel-plated brass

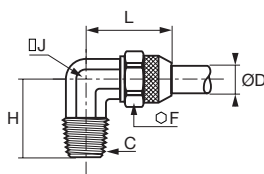

ØD	C		F	H	J	L	Kg
7.5x10	R1/4	C3BPL7.5/10-1/4	16	22.5	12	28	0.057
	R3/8	C3BPL7.5/10-3/8	16	23	12	28	0.058
11x14	R3/8	C3BPL11/14-3/8	22	25	16	34	0.094

Compatible with BPLM nut only

Maximum working pressure: 40 bar

C4BPL Stud Elbow, Male BSPP Thread

Nickel-plated brass, NBR

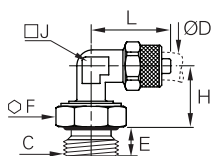

ØD	C		E	F	F1	H	J	L	Kg
6x8	G1/4	C4BPL6/8-1/4	8	17	14	25	10	23.5	0.068

These fittings are supplied with nitrile seals.

Compatible with BPLM-M nut only

C8BPL-1 Stud Elbow, Male Metric Thread

Nickel-plated brass, NBR

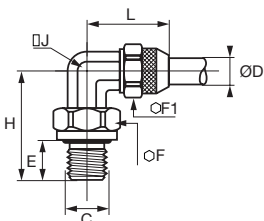

ØD	C		E	F	F1	H	J	L	Kg
6x8	M10x1	C8BPL6/8M10	7	14	13	27	10	22	0.034
	M12x1	C8BPL6/8M12	7	13	13	26	12	25	0.074

These fittings are supplied with nitrile seals.

Compatible with BPLM nut only

Maximum working pressure: 40 bar

Stud Fittings

R3BPL Stud Run Tee, Male BSPT Thread

Nickel-plated brass

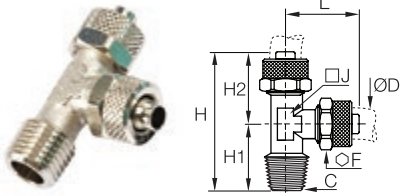

	ØD	C		F	H	H1	H2	J	Kg
4x6	R1/8	R3BPL4/6-1/8		12	39.5	17	22.5	8	0.035
	R1/4	R3BPL4/6-1/4		12	43.5	21	22.5	10	0.048
6x8	R1/8	R3BPL6/8-1/8		14	40.5	18	22.5	10	0.045

Compatible with BPLM-M nut only

S3BPL Stud Branch Tee, Male BSPT Thread

Nickel-plated brass

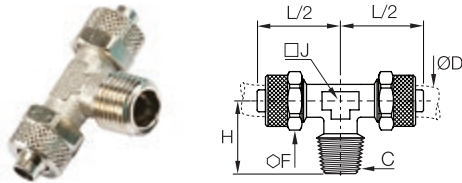

	ØD	C		F	H	J	L2	Kg
4x6	R1/8	S3BPL4/6-1/8		12	17	8	22.5	0.035
	R1/4	S3BPL4/6-1/4		12	20.5	10	22.5	0.047
6x8	R1/8	S3BPL6/8-1/8		14	17.5	10	22.5	0.046

Compatible with BPLM-M nut only

COR4BPL Single Banjo, Male BSPP Thread

Nickel-plated brass, treated steel, NBR

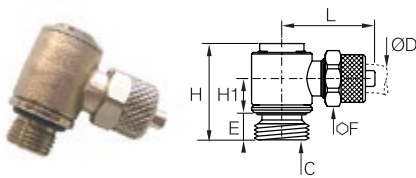

	ØD	C		E	F	H	H1	L	Kg
4x6	G1/8	COR4BPL4/6-1/8		6.5	12	25.5	9	24	0.069
	G1/4	COR4BPL4/6-1/4		8	12	31.5	10	26	0.097
6x8	G1/8	COR4BPL6/8-1/8		6.5	14	25.5	9	24	0.073

These parts are supplied with peripheral seals.

The banjo bolt is made of steel.

Compatible with BPLM-M nut only

PL Tube-to-Tube and Complementary Fittings

HBPL Equal Tube-to-Tube Connector

Nickel-plated brass

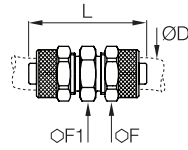

ØD		F	F1	L	Kg
2.7x4	HBPL2.7/4	8	8	26	0.010
4x6	HBPL4/6	12	12	34.5	0.021
6x8	HBPL6/8	14	14	35	0.030
8x10	HBPL8/10	14	16	38	0.043
10x12	HBPL10/12	17	18	41	0.056

Compatible with BPLM-M nut only

HBPL-1 Equal Tube-to-Tube Connector

Nickel-plated brass

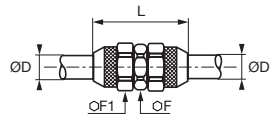

ØD		F	F1	L	Kg
11x14	HBPL11/14	19	22	40	0,087

Compatible with BPLM nut only
Maximum working pressure: 40 bar

JBPL Equal Tee

Nickel-plated brass

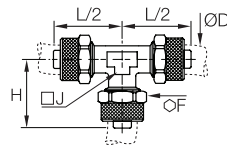

ØD		F	H	J	L2	Kg
2.7x4	JBPL2.7/4	8	20	8	22	0.035
4x6	JBPL4/6	12	22.5	8	22.5	0.042
6x8	JBPL6/8	14	22.5	10	22.5	0.057
8x10	JBPL8/10	16	25.5	11	25.5	0.085
10x12	JBPL10/12	18	30	14	30	0.100

Compatible with BPLM-M nut only

JBPL-1 Equal Tee

Nickel-plated brass

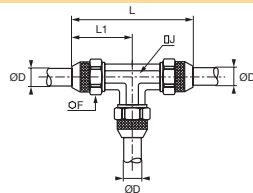

ØD		F	J	L	L1	Kg
7.5x10	JBPL7.5/10	16	12	56	28	0.086
11x14	JBPL11/14	22	16	68	34	0.168

Compatible with BPLM nut only
Maximum working pressure: 40 bar

PL Tube-to-Tube and Complementary Fittings

WBPL

Equal Bulkhead Connector

Nickel-plated brass

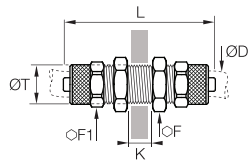

ØD		F	F1	K _{max}	L	ØT	Kg
4x6	WBPL4/6	14	12	10.5	48	10	0.030
6x8	WBPL6/8	16	14	10.5	48	12	0.040
8x10	WBPL8/10	17	16	8.5	50	14	0.057
10x12	WBPL10/12	19	18	8.5	53	26	0.064

Compatible with BPLM-M nut only

WBPL-1

Equal Bulkhead Connector

Nickel-plated brass

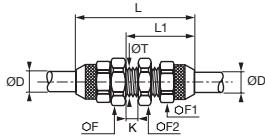

ØD		F	F1	F2	K _{max}	L	L1	ØT	Kg
11x14	WBPL11/14	22	22	22	5	50	28	19	0.114

Compatible with BPLM nut only
Maximum working pressure: 40 bar.

BPLM

Nut

Nickel-plated brass

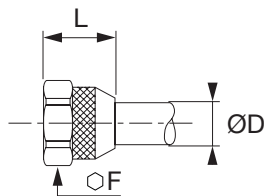

ØD	C		F	L	Kg
6x8	M11x0.75	BPL8M	13	13	0.008
7.5x10	M13x1	BPL10M	16	14	0.014
11x14	M18x1.5	BPL14M	22	18	0.018

Maximum working pressure: 40 bar

BPLM-M

Nut

Nickel-plated brass

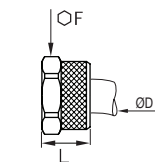

ØD	C		F	L	Kg
2.7x4	M6x0.50	BPL4M-1	8	8	0.003
4x6	M8x0.75	BPL6M-1	9	9	0.006
6x8	M12x1	BPL8M-1	14	10.5	0.008
8x10	M14x1	BPL10M-1	16	11.5	0.012
10x12	M16x1	BPL12M-1	18	13	0.014

0164

Adaptor, Male NPT/Female BSPP Thread

Nickel-plated brass

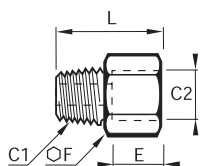

C1	C2		E	F	L	Kg
NPT1/8	G1/8	0164 11 10 99	7.5	14	20	0.015
NPT1/4	G1/4	0164 14 13 99	11	17	27.5	0.028
NPT3/8	G3/8	0164 18 17 99	11.5	22	28.5	0.044

Maximum working pressure: see page 9-6, brass adaptors.

Industrial Valves

Ball Valves

LIQUIfit®

Needle and Butterfly Valves

Axial Valves



Industrial Valves

Ball Valves, Universal Series

(P. 6-8)



Fluids: compressed air, slightly corrosive fluids

Materials: nickel-plated forged brass

Pressure: 40 bar

Temperature: -40°C to +80°C

DN: 4 mm to 40 mm

Ball Valves, Universal Series, Vented

(P. 6-13)



Fluids: compressed air, slightly corrosive fluids

Materials: nickel-plated forged brass

Pressure: 40 bar

Temperature: -20°C to +80°C

DN: 4 mm to 23 mm

Ball Valves, Universal Series, Lockable

(P. 6-15)



Fluids: compressed air, slightly corrosive fluids

Materials: nickel-plated forged brass, galvanised steel and epoxy locking system

Pressure: 40 bar

Temperature: -40°C to +80°C

DN: 4 mm to 23 mm

Ball Valves, Universal Customised Series

(P. 6-9)



Fluids: compressed air, many fluids

Materials: nickel-plated forged brass, choice of seal material (NBR, EPDM, FKM, PTFE...)

Pressure: 40 bar

Temperature: -40°C to +100°C

DN: 4 mm to 40 mm

Ball Valves, Universal Light Series

(P. 6-16)



Fluids: compressed air, slightly corrosive fluids

Materials: forged brass or nickel-plated forged brass

Pressure: 12 bar

Temperature: -20°C to +80°C

DN: 4 mm to 13 mm

Ball Valves, DVGW Series

(P. 6-20)



Fluids: compressed air, water, gas

Materials: nickel-plated forged brass

Pressure: 40 bar

Temperature: -50°C to +170°C

DN: 8 mm to 50 mm

Ball Valves, Standard Series

(P. 6-22)



Fluids: compatible fluids

Materials: nickel or chromium-plated brass with PTFE seal

Pressure: 35 bar

Temperature: -20°C to +130°C

DN: 8 mm to 100 mm

Ball Valves, Stainless Steel Series

(P. 6-28)



Fluids: all fluids

Materials: 316L stainless steel

Pressure: 65 bar

Temperature: -20°C to +150°C

DN: 8 mm to 50 mm

Ball Valves, Stainless Steel Light Series

(P. 6-28)



Fluids: all fluids

Materials: 316L stainless steel

Pressure: 65 bar

Temperature: -20°C to +120°C

DN: 4 mm to 10 mm

Industrial Valves

Ball Valves, High Pressure Series

[P. 6-30]



Fluids: lubricants, gases
Materials: zinc-plated brass
Pressure: 300 bar
Temperature: -15°C to +80°C
DN : 7 mm to 13 mm

Ball Valves, Mini Series

[P. 6-32]



Fluids: compressed air
Materials: technical polymer
Pressure: 10 bar
Temperature: -20°C to +80°C
DN : 4 mm to 12 mm

Ball Valves, LIQUIfit®

[P. 6-34]



Fluids: water, beverages, CO₂, inert gases
Materials: polypropylene, EPDM seal
Pressure: 10 bar
Temperature: -15°C to +100°C
Ø inch: 1/4" and 3/8"
Ø metric: 6 mm to 12 mm

Needle Valves, Brass

[P. 6-37]



Fluids: compressed air, industrial fluids
Materials: shot-blasted forged brass, nickel-plated
Pressure: 120 bar
Temperature: -20°C to +100°C
DN : 4 mm to 10 mm

Needle Valves, Stainless Steel

[P. 6-41]



Fluids: all fluids
Materials: 316L stainless steel
Pressure: 400 bar
Temperature: -20°C to +180°C
DN : 3 mm to 6 mm

Butterfly Valves

[P. 6-42]



Fluids: compressed air, abrasive fluids
Materials: shot-blasted forged brass, nickel-plated
Pressure: 16 bar
Temperature: -20°C to +80°C
DN : 6 mm to 18 mm

Axial Valves

[P. 6-45]



Fluids: compressed air, industrial fluids
Materials: nickel-plated brass
Pressure: 10 bar
Temperature: -20°C to +135°C
Threads : 3/8" to 2"

Ball Valve Range

Universal and Universal Customised Series

In-Line

0402 2/2 Page 6-10
0401 2/2 Page 6-10
0400 2/2 Page 6-10
0411 2/2 Page 6-10
0414 2/2 Page 6-10



In-Line with Fixing Holes and Panel Mounting

0446 2/2 Page 6-11
6402 2/2 Page 6-11
6401 2/2 Page 6-11



Right-Angled

0472 2/2 Page 6-11
0471 2/2 Page 6-11



In-Line, 3-Way

0482 3/3 Page 6-12
0483 3/3 Page 6-12



In-Line, 3-Way with Fixing Holes and Panel Mounting

0448 3/3 Page 6-12
0452 3/2 Page 6-12



Universal Series, Vented

In-Line

0489 3/2 Page 6-13
0449 3/2 Page 6-13
0469 3/2 Page 6-13



Right-Angled

0462 3/2 Page 6-14
0461 3/2 Page 6-14



Universal Lockable Series

In-Line

0432 2/2 Page 6-15



In-Line, Vented

0439 3/2 Page 6-15
0436 3/2 Page 6-15
0437 3/2 Page 6-15



In-Line, 3-Way

0438 3/2 Page 6-15



Universal Light Series

In-Line

0492 2/2 Page 6-17
0491 2/2 Page 6-17
0490 2/2 Page 6-17



In-Line, Vented

0494 2/2 Page 6-18



In-Line with Square Stem

0497 2/2 Page 6-18
0496 2/2 Page 6-18



Ball Valve Range

DVGW Series

In-Line

BVG4-L

2/2
Page 6-21



BVGT4-L

2/2
Page 6-21



Standard Series

In-Line

4902

2/2
Page 6-23



BVGT4-C

2/2
Page 6-23



Compact

4991

2/2
Page 6-23



4992

2/2
Page 6-23



In-Line, Lockable

BVG4-LOCK

2/2
Page 6-24



In-Line, Lockable, Vented

BVG4P-LOCK

3/2
Page 6-24



Stainless Steel Series

In-Line

4832

Mountable and dismountable
2/2
Page 6-29



4812

Mountable
2/2
Page 6-29



4810

One-Piece Construction
2/2
Page 6-29



0465

Light Series
2/2
Page 6-29



High Pressure Series

In-Line

4402

2/2
Page 6-31



Mini Series

In-Line

7910

2/2
Page 6-33



7911

2/2
Page 6-33



In-Line, Vented and Accessories

7913

3/2
Page 6-33



7914

3/2
Page 6-33



7000

Page 6-33



LIQUIfit®

In-Line

4020

2/2
Page 6-35



4020

2/2
Page 6-35



4021

2/2
Page 6-35



4023

2/2
Page 6-35



Right-Angled

4022

2/2
Page 6-35



4024

2/2
Page 6-35



Accessories

3130

Page 6-35



Ball Valves, Universal Series

This range of valves has patented **seal wear compensating** technology for **reliable** and **durable** sealing, **protecting** any system whether under pressure or **vacuum**.

Product Advantages

Durability & Reliability

Automatic seal wear compensation for long-term reliability
Robust, corrosion-resistant materials
100% leak-tested in production
Date coding to guarantee quality and traceability

Versatility & Performance

Ideal for ensuring the performance of pneumatic circuits
Customised valves for all special applications
Unequalled performance under vacuum
Smooth operation thanks to self-lubricating seals
Large range of working pressures and temperatures
Lever can be repositioned and replaced
Many configurations to satisfy all system requirements



Applications

- Pneumatics
- Vacuum
- Transportation
- Packaging
- Textile
- Sawmill
- Rubber & Plastics

Technical Characteristics

Compatible Fluids	Industrial fluids
Working Pressure	Vacuum to 40 bar
Working Temperature	-40°C to + 80°C

Tightening Torques	Threads	G1/8	G1/4	G3/8	G1/2	G3/4	G1
	daN.m	0.10 to 0.20	0.10 to 0.20	0.15 to 0.25	0.20 to 0.35	0.50 to 0.70	0.50 to 0.70
	Threads	G1¼	G1½	G2			
	daN.m	0.40 to 0.60	0.80 to 1.20	0.80 to 1.20			

Reliable performance is dependent upon the type of fluid conveyed, component materials and tubing being used.
Guaranteed for use with a vacuum of 755 mm Hg (99 % vacuum).

Component Materials

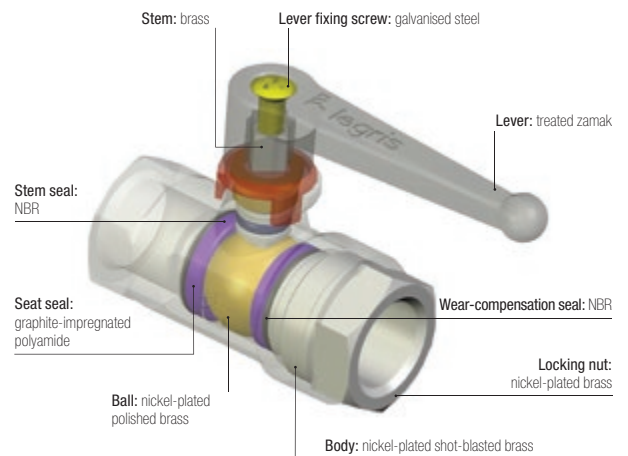

Silicone-free

Regulations

DI: 97/23/EC (module PED A - diameters greater than 25 mm)
DI: 2006/42/EC (Machinery Directive)
DI: 2002/95/EC (RoHS)
RG: 1907/2006 (REACH)

Universal Series

Installation Options

Lockable Valves

Our lockable ball valves have been developed in order to prevent potentially dangerous consequences caused by unintended operation. Lockable in different positions, this range meets international safety requirements, such as ISO 4414.

The valves are lockable:

- at one point: models 0432 and 0439
- at three points: models 0437 and 0438

Vented Valves

To stop fluid circulation and vent the circuit, 2 venting systems are provided:

- with threaded exhaust, to allow discharge of downstream media
- with pin-hole vent, for applications with no special discharge requirement

Fluid flow direction is indicated by an arrow on the valve body.

Mountable Valves

On steel plate:

- bulkhead fixing
- complete valve below bulkhead

On frame:

- assemble with bolts

On wooden panel:

- assemble with woodscrews

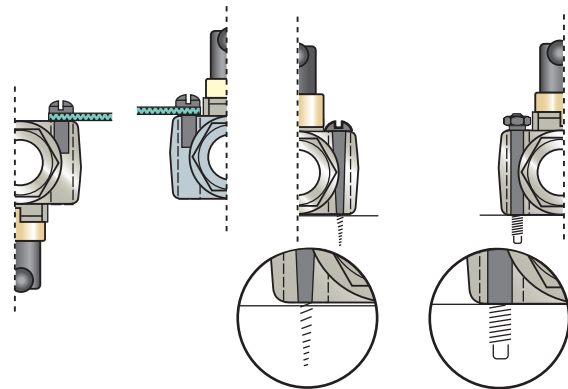

Universal Customised Valve Series

Based on the standard components of the universal series, this range allows the valve to be adapted to specific needs. There are 6 product versions available on request.

Product Codes

Valve type	0402	04	10	22	Suffix
0400		04 = 4 mm 05 = 5 mm ... 40 = 40 mm	10 = 1/8" 13 = 1/4" ... 48 = 2"	20 = blue/red 22 = green/blue 26 = yellow/yellow 27 = blue/green 30 = white/red 32 = white/green	0400
0401					0401
0402					0402
...					...

Identification

Each series may be easily identified by a colour marking on the lever.

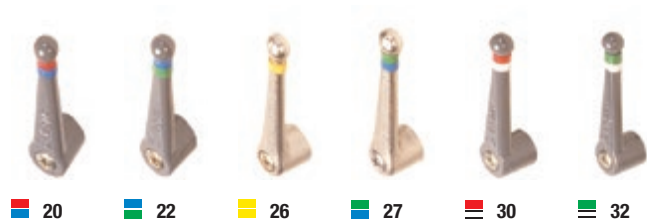

Suffix Specification

Identification		Body		Lever			Ball		Stem and Wear-Compensation Seals			Seat Seals			Application Examples
Suffix on the body	Colour bands on the lever	Nickel-plated brass	Chemical nickel-plated brass	Standard	Nickel-plated brass	Chemical nickel-plated brass	Nickel-plated polished brass	Chemical nickel-plated brass	EPDM	FKM	PTFE white	Rilsan: graphite-impregnated	Filled PTFE	PTFE white	
20		•		•			•			•		•			Hydrocarbons
22		•		•				•		•			•		Industrial fluids and high temperature
26*		•			•			•			• olive			•	Corrosive liquids or high temperature and compatible for use at -50°C
27			•			•		•		•			•		Industrial fluids and/or harsh environments
30**		•		•			•		•			•			Gaseous oxygen circuits
32		•		•			•		•				•		Water and steam circuits

*degreased **oxygen-compatible grease

A usage chart in this chapter shows which type of valve to use according to the fluid being conveyed.

Universal Series

0402 2/2 In-Line Ball Valve, Female BSPP Thread



Nickel-plated brass, NBR

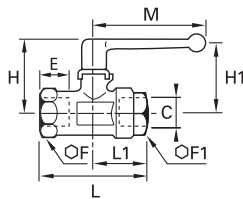

DN	C		E	F	F1	H	H1	L	L1	M	Kg
4	G1/8	0402 04 10	8	-	14	35	29	44	25	48	0.094
7	G1/8	0402 07 10	8	19	19	38	31	51	27	48	0.165
	G1/4	0402 07 13	12	19	19	38	31	53	28	48	0.156
10	G3/8	0402 10 17	12	24	24	45	43	59	31	69	0.244
13	G1/2	0402 13 21	15	27	27	47	44	67	34	69	0.292
20	G3/4	0402 20 27	16.5	32	38	63	54	80	39	108	0.655
23	G1	0402 23 34	19	41	46	67	57	94	47	108	1.036
32	G1 1/4	0402 32 42*	21.5	55	60	97	115	112	59	180	2.467
	G1 1/2	0402 32 49*	22	55	60	97	115	120	62	180	2.340
40	G1 1/2	0402 40 49*	22	55	55	104	-	111	55	190	2.445
	G2	0402 40 48*	26	70	70	104	-	122	61	190	2.614

*Models with EC marking

Maximum working pressure: 40 bar

0401 2/2 In-Line Ball Valve, Male/Female BSPP Thread



Nickel-plated brass, NBR

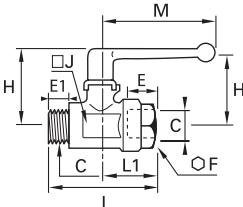

DN	C		E	E1	F	H	H1	J	L	L1	M	Kg
4	G1/8	0401 04 10	8	7	14	35	29	14	45	25	48	0.094
5	G1/8	0401 05 10	8	7	19	38	31	19	51	27	48	0.160
7	G1/4	0401 07 13	12	9	19	38	31	19	52	28	48	0.150
10	G3/8	0401 10 17	12	11	24	45	43	24	58	31	69	0.234
13	G1/2	0401 13 21	15	12	27	47	44	27	66	34	69	0.286
18	G3/4	0401 18 27	16.5	12	38	63	54	39	79	39	108	0.652
23	G1	0401 23 34	19	15	46	67	57	48	91	47	108	0.952
32	G1 1/4	0401 32 42*	21.5	18	60	97	115	55	113	59	108	2.385

*Models with EC marking

Maximum working pressure: 40 bar

0400 2/2 In-Line Ball Valve, Male BSPP Thread



Nickel-plated brass, NBR

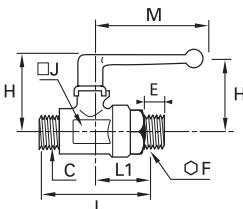

DN	C		E	F	H	H1	J	L	L1	M	Kg
4	G1/8	0400 04 10	7	14	35	29	14	45	25	48	0.094
7	G1/4	0400 07 13	9	19	38	31	19	60	36	48	0.166
10	G3/8	0400 10 17	11	24	45	43	24	70	43	69	0.252
13	G1/2	0400 13 21	12	27	47	44	27	78	45	69	0.324
18	G3/4	0400 18 27	12	38	63	54	39	90	50	108	0.714

Maximum working pressure: 40 bar

0411 2/2 In-Line Ball Valve with Connections for Use with Steel Tube



Nickel-plated brass, NBR

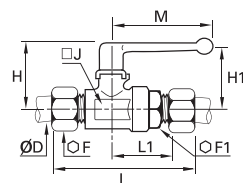

DN	ØD		F	F1	H	H1	J	L	L1	M	Kg
4	6	0411 04 06	14	19	38	31	19	76	30	48	0.173
6	8	0411 06 08	17	19	38	31	19	77	30	48	0.195
7	10	0411 07 10	19	19	38	31	19	78	31	48	0.210
10	12	0411 10 12	22	24	45	43	24	85	36	69	0.310

Maximum working pressure: 40 bar

0414 2/2 In-Line Ball Valve with Compression Connections



Nickel-plated brass, NBR

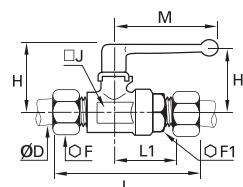

DN	ØD		F	F1	H	H1	J	L	L1	M	Kg
4	6	0414 04 06	13	19	38	31	19	72	31	48	0.177
6	8	0414 06 08	14	19	38	31	19	74	30	48	0.180
7	10	0414 07 10	19	19	38	31	19	78	31	48	0.210
10	12	0414 10 12	22	24	45	43	24	86	36	69	0.308

Maximum working pressure: 40 bar

Universal Series

0446 2/2 In-Line Panel-Mountable Ball Valve, Female BSPP Thread



Nickel-plated brass, NBR

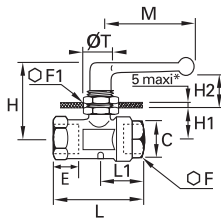

DN	C		E	F	F1	H	H1	H2	L	L1	M	ØT	Kg
4	G1/8	0446 04 10	8	14	22	37	14	12	44	25	48	16.5	0.112
7	G1/4	0446 07 13	12	19	24	45	19	14	53	28	48	20.5	0.188
10	G3/8	0446 10 17	12	24	27	50	21	21	59	31	69	20.5	0.294
13	G1/2	0446 13 21	15	27	27	51	23	21	67	34	69	20.5	0.338

Maximum working pressure: 20 bar

*For G1/8 version, maximum panel thickness = 3 mm

6402 2/2 In-Line Ball Valve for Screw Fixing, Female BSPP Thread



Nickel-plated brass, NBR

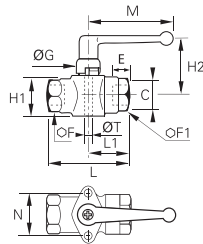

DN	C		E	F	F1	G	H1	H2	L	L1	M	N	ØT	Kg
4	G1/8	6402 04 10	8	14	14	18	18	30	44	25	48	25	4x70	0.132
7	G1/4	6402 07 13	12	19	19	19	24	31	53	28	48	31	5x80	0.216
10	G3/8	6402 10 17	12	24	24	20	30	45	59	31	69	31	5x80	0.324
13	G1/2	6402 13 21	15	27	27	20	34	47	67	34	69	34	6x100	0.404
20	G3/4	6402 20 27	16.5	32	38	27	44	52	80	39	108	43	8x125	0.830
23	G1	6402 23 34	19	41	46	27	53	56	94	47	108	51	8x125	1.290

Maximum working pressure: 40 bar

6401 2/2 In-Line Ball Valve for Screw Fixing, Male/Female BSPP Thread

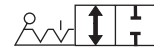

Nickel-plated brass, NBR

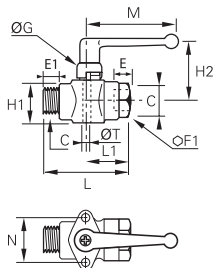

DN	C		E	E1	F	G	H1	H2	L	L1	M	N	ØT	Kg
4	G1/8	6401 04 10	8	7	14	18	18	30	45	25	48	25	4x70	0.127
7	G1/4	6401 07 13	12	9	19	19	24	31	52	28	48	31	5x80	0.212
10	G3/8	6401 10 17	12	11	24	20	30	45	58	31	69	31	5x80	0.306
13	G1/2	6401 13 21	15	12	27	20	34	47	67	34	69	34	6x100	0.394

Maximum working pressure: 40 bar

0472 2/2 Right-Angled Ball Valve, Female BSPP Thread



Nickel-plated brass, NBR

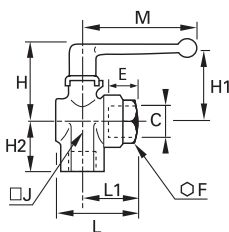

DN	C		E	F	H	H1	H2	J	L	L1	M	Kg
4	G1/8	0472 04 10	8	14	35	29	18	14	34	25	48	0.096
6	G1/8	0472 06 10	8	19	38	31	20	22	37	27	48	0.183
	G1/4	0472 06 13	12	19	38	31	24	22	38	28	48	0.191
9	G3/8	0472 09 17	12	24	45	43	27	25	46	31	69	0.260
12	G1/2	0472 12 21	15	27	47	44	33	29	49	34	69	0.312
18	G3/4	0472 18 27	16.5	38	59	51	40	39	60	39	108	0.704
23	G1	0472 23 34	19	46	63	55	47	48	72	47	108	1.062

Maximum working pressure: 20 bar

0471 2/2 Right-Angled Ball Valve, Male/Female BSPP Thread



Nickel-plated brass, NBR

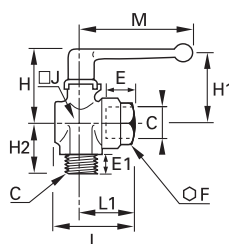

DN	C		E	E1	F	H	H1	H2	J	L	L1	M	Kg
4	G1/8	0471 04 10	8	7	14	35	29	19	14	34	25	48	0.096
6	G1/8	0471 06 10	8	7	19	38	31	22	22	37	27	48	0.182
	G1/4	0471 06 13	12	9	19	38	31	25	22	38	28	48	0.187
9	G3/8	0471 09 17	12	11	24	45	43	28	25	46	31	69	0.256
12	G1/2	0471 12 21	15	12	27	47	44	32	29	49	34	69	0.303
18	G3/4	0471 18 27	16.5	12	38	59	51	37	39	60	39	108	0.682
23	G1	0471 23 34	19	15	46	63	55	44	48	72	47	108	1.020

Maximum working pressure: 20 bar

Universal Series

0482 3/3 Right-Angle Ported Ball Valve, Female BSPP Thread

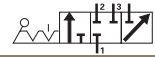

Nickel-plated brass, NBR

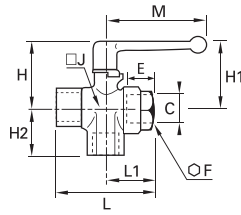

DN	C		E	F	H	H1	H2	J	L	L1	M	Kg
4	G1/8	0482 04 10	8	14	35	29	18	14	44	25	48	0.102
6	G1/4	0482 06 13	12	19	38	31	24	22	53	28	48	0.200
9	G3/8	0482 09 17	12	24	45	43	27	25	59	31	69	0.284
12	G1/2	0482 12 21	15	27	47	44	33	29	67	34	69	0.346
18	G3/4	0482 18 27	16.5	38	59	51	40	39	80	39	108	0.742
23	G1	0482 23 34	19	46	63	55	47	48	94	47	108	1.160

Maximum working pressure: 20 bar

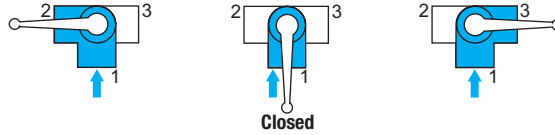

0483 3/3 Right-Angle Ported Ball Valve Without Closed Position, Female BSPP Thread



Nickel-plated brass, NBR

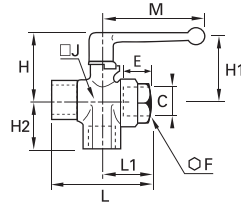

DN	C		E	F	H	H1	H2	J	L	L1	M	Kg
4	G1/8	0483 04 10	8	14	35	29	18	14	44	25	48	0.102
6	G1/4	0483 06 13	12	19	38	31	24	22	53	28	48	0.196
9	G3/8	0483 09 17	12	24	45	43	27	25	59	31	69	0.278
12	G1/2	0483 12 21	15	27	47	44	33	29	67	34	69	0.340
18	G3/4	0483 18 27	16.5	38	59	51	40	39	80	39	108	0.716
23	G1	0483 23 34	19	46	63	55	47	48	94	47	108	1.066

Maximum working pressure: 20 bar

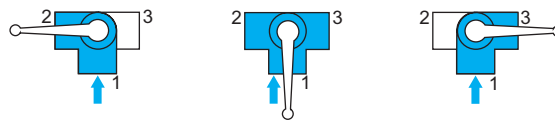

0448 3/3 Panel-Mountable Right-Angled Ball Valve, Female BSPP Thread

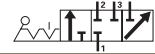

Nickel-plated brass, NBR

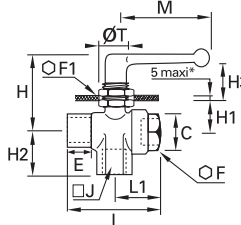

DN	C		E	F	F1	H	H1	H2	H3	J	L	L1	M	ØT	Kg
4	G1/8	0448 04 10*	8	14	22	37	14	18	12	14	44	25	48	16.5	0.126
6	G1/4	0448 06 13	12	19	24	45	19	24	14	22	53	28	48	20.5	0.230
9	G3/8	0448 09 17	12	24	27	50	21	27	21	25	59	31	69	20.5	0.328
12	G1/2	0448 12 21	15	27	27	51	23	33	21	29	67	34	69	20.5	0.392

Maximum working pressure: 20 bar

*For G1/8 version: maximum panel thickness = 3 mm

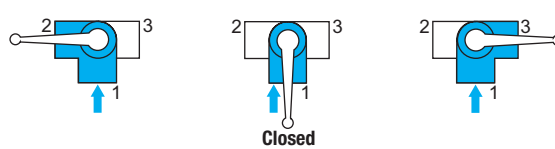

0452 3/2 Panel-Mountable Equal Plane Ball Valve, Female BSPP Thread



Nickel-plated brass, NBR

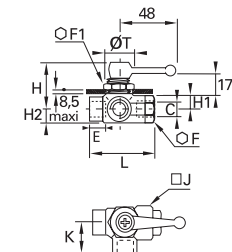

DN	C		E	F	F1	H	H1	H2	J	K	L	ØT	Kg
4	G1/8	0452 04 10	8	14	22	39	10	8	16	18	25	19	0.130
6	G1/4	0452 06 13	12	19	24	40	11	11	23	24	28	20	0.206

Maximum working pressure: 20 bar

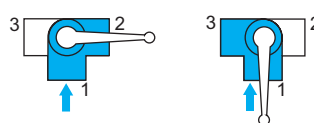

Universal Series, Vented

0489

3/2 In-Line Vented Ball Valve, Female BSPP and Metric Thread

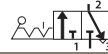

Nickel-plated brass, NBR

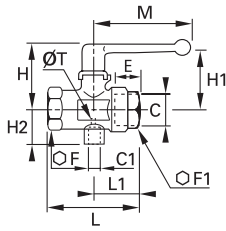

DN	C	C1		E	F	F1	H	H1	H2	L	L1	M	ØT	Kg
7	G1/4	M5x0.8	0489 07 13	12	24	24	46	43	17	59	31	69	2	0.270
10	G3/8	M5x0.8	0489 10 17	12	24	24	46	43	17	59	31	69	2	0.243
13	G1/2	G1/8	0489 13 21	15	27	27	47	44	24	67	34	69	2	0.310
18	G3/4	G1/4	0489 18 27	16.5	32	38	63	54	33	80	39	108	2.5	0.670
23	G1	G1/4	0489 23 34	19	41	46	67	57	37	94	47	108	3	1.050

Maximum working pressure: 40 bar

0449

3/2 Panel-Mountable In-Line Ball Valve, Female BSPP and Metric Thread

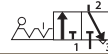

Nickel-plated brass, NBR

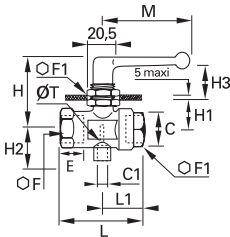

DN	C	C1		E	F	F1	H	H1	H2	H3	L	L1	M	ØT	Kg
7	G1/4	M5x0.8	0449 07 13	12	24	27	50	20	17	21	59	31	69	2.5	0.313
10	G3/8	M5x0.8	0449 10 17	12	24	27	50	20	17	21	59	31	69	2.5	0.291
13	G1/2	G1/8	0449 13 21	15	27	27	52	23	24	21	67	34	69	4	0.352

Maximum working pressure: 20 bar

0469

3/2 In-Line Vented Ball Valve, Female BSPP Thread



Nickel-plated brass, NBR

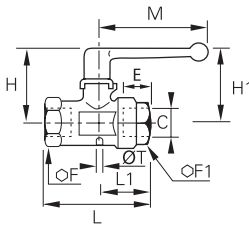

DN	C		E	F	F1	H	H1	L	L1	M	ØT	Kg
4	G1/8	0469 04 10	8	14	14	35	29	44	25	48	1.5	0.092
7	G1/4	0469 07 13	12	24	24	46	43	59	31	70	2	0.268
10	G3/8	0469 10 17	12	24	24	46	43	59	31	70	2	0.246
13	G1/2	0469 13 21	15	27	27	47	44	67	34	70	2	0.293
18	G3/4	0469 18 27	16.5	32	38	63	54	80	39	108	2.5	0.668
23	G1	0469 23 34	19	41	46	67	57	94	47	108	3	1.026

Maximum working pressure: 40 bar

Operation of Vented Ball Valves

With vent connected to a tube = collection of purged media

With vent connected to a silencer = noiseless discharge to atmosphere

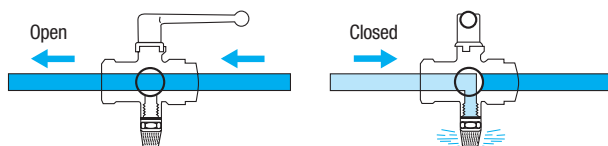
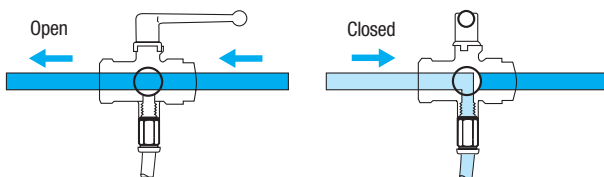

You will find our ranges of fittings, tubing and silencers in Chapters 1, 3 and 4.

Universal Series, Vented

0462 3/2 Right-Angled Ball Valve with Vent, Female BSPP Thread



Nickel-plated brass, NBR

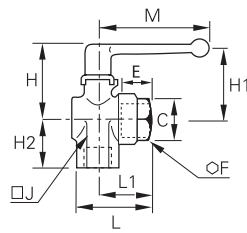

DN	C		E	F	H	H1	H2	J	L	L1	M	Kg
6	G1/8	0462 06 10	8	19	38	31	20	22	37	27	48	0.192
	G1/4	0462 06 13	12	19	38	31	24	22	38	28	48	0.185
9	G3/8	0462 09 17	12	24	45	43	27	25	46	31	69	0.261
12	G1/2	0462 12 21	15	27	47	44	33	29	49	34	69	0.311
18	G3/4	0462 18 27	16.5	38	59	51	40	39	60	39	108	0.698
23	G1	0462 23 34	19	46	63	55	47	48	72	47	108	1.066

Maximum working pressure: 20 bar

0461 3/2 Right-Angled Ball Valve with Vent, Male/Female BSPP Thread



Nickel-plated brass, NBR

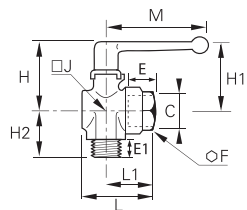

DN	C		E	E1	F	H	H1	H2	J	L	L1	M	Kg
6	G1/8	0461 06 10	8	7	19	38	31	20	22	37	27	48	0.182
	G1/4	0461 06 13	12	9	19	38	31	24	22	38	28	48	0.186
9	G3/8	0461 09 17	12	11	24	45	43	27	25	46	31	69	0.257
12	G1/2	0461 12 21	15	12	27	47	44	33	29	49	34	69	0.304
18	G3/4	0461 18 27	16.5	12	38	59	51	40	39	60	39	108	0.648

Maximum working pressure: 20 bar

Operation of Right-Angled Vented Ball Valves

Operation of Lockable Vented Ball Valves

With pin-hole vent = purge to atmosphere without silencer

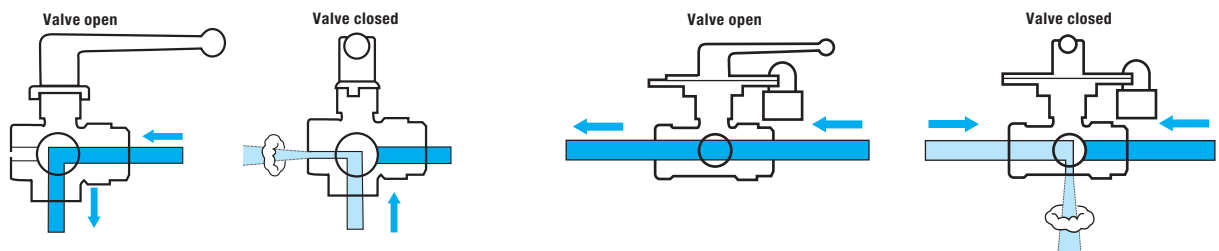

Removable lever: where the lever is obstructed in its movement, it can be refitted the opposite way.

Operation of 3/2 Lockable Valves

Drilled below and square in the horizontal plane, these valves provide a connection between: either port 1 and port 2, or port 2 and port 3.

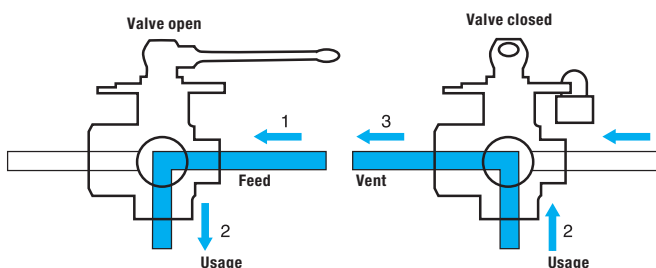

Removable lever: where the lever is obstructed in its movement, it can be refitted the opposite way.

Universal Series, Lockable

0432 2/2 In-Line Lockable Ball Valve, Female BSPP Thread



Nickel-plated brass, NBR

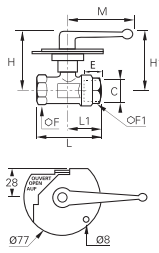

DN	C		E	F	F1	H	H1	L	L1	M	Kg
4	G1/8	0432 04 10	8	19	19	59	54	51	27	69	0.415
7	G1/4	0432 07 13	12	19	19	59	54	59	28	69	0.396
10	G3/8	0432 10 17	12	24	24	60	55	59	31	69	0.460
13	G1/2	0432 13 21	15	27	27	62	57	67	34	69	0.510
20	G3/4	0432 20 27	16.5	32	38	66	56	80	39	108	0.800
23	G1	0432 23 34	19	41	46	70	59	94	47	108	1.186

Maximum working pressure: 40 bar

Handle is not removable.

Fixed and mobile plates: zinc-plated steel.

0439 3/2 In-line Vented Lockable Ball Valve, Female BSPP Thread



Nickel-plated brass, NBR

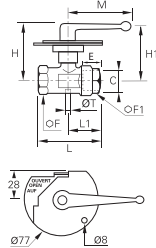

DN	C		E	F	F1	H	H1	L	L1	M	ØT	Kg
4	G1/8	0439 04 10	8	19	19	59	54	51	27	69	2	0.410
7	G1/4	0439 07 13	12	24	24	60	55	59	31	69	2	0.480
10	G3/8	0439 10 17	12	24	24	60	55	59	31	69	2	0.460
13	G1/2	0439 13 21	15	27	27	62	57	67	34	69	2	0.514
18	G3/4	0439 18 27	16.5	32	38	66	56	80	39	108	2.5	0.810
23	G1	0439 23 34	19	41	46	70	59	94	47	108	3	1.185

Maximum working pressure: 40 bar

Handle is not removable, locking plates are zinc-plated steel.

0436 3/2 In-Line Lockable Ball Valve with Threaded Exhaust Port, Female BSPP and Metric Thread



Nickel-plated brass, NBR

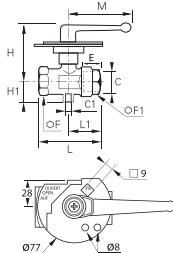

DN	C	C1		E	F	F1	H	H1	L	L1	M	Kg
10	G3/8	M5x0.8	0436 10 17	12	24	24	60	17	60	32	69	0.475
13	G1/2	G1/8	0436 13 21	15	27	27	60	24.5	67.5	34.5	69	0.500
18	G3/4	G1/4	0436 18 27	16.5	32	38	69.5	33	80	39.5	108	0.850
23	G1	G1/4	0436 23 34	19	32	38	69.5	33	80	39.5	108	1.215

Maximum working pressure: 40 bar

Handle is not removable.

Fixed and mobile plates: zinc-plated steel

0437 3/2 In-line Vented 3-Point Lockable Ball Valve, Female BSPP Thread



Nickel-plated brass, NBR

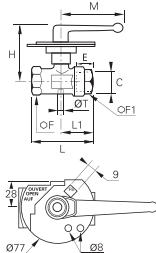

DN	C		E	F	F1	H	L	L1	M	ØT	Kg
7	G1/4	0437 07 13	12	24	24	60	59	32	69.5	2	0.476
10	G3/8	0437 10 17	12	24	24	60	60	32	69.5	2	0.447
13	G1/2	0437 13 21	15	27	27	60	67.5	34.5	69.5	2	0.510
18	G3/4	0437 18 27	16.5	32	38	69.5	80	39.5	108.5	2.5	0.820
23	G1	0437 23 34	19	41	46	73	94.5	47.5	108.5	3	1.192

Maximum working pressure: 40 bar

Handle is not removable

Locking plates are zinc-plated steel

0438 3/2 Right-Angled 3-Point Lockable Ball Valve, Female BSPP Thread



Nickel-plated brass, NBR

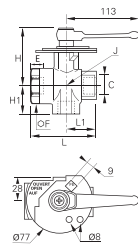

DN	C		E	F	H	H1	J	L	L1	Kg
9	G3/8	0438 09 17	12	38	76	34	39	73	35	0.970
12	G1/2	0438 12 21	15	38	76	37	39	78	38	0.947
18	G3/4	0438 18 27	16.5	38	76	40	39	80	40	0.905
23	G1	0438 23 34	19	46	80	47	48	94	47	1.295

Maximum working pressure: 20 bar

Fixed plate: zinc-plated steel, mobile plate: steel, grey epoxy-coated

Removable handle: where the handle is obstructed in its movement, it can be refitted opposite the original position.

Ball Valves, Universal Light Series

Using the Universal Series technology, the Parker Legris light series valves offer the advantages of **compactness**, **ease of operation** and **long-term reliability**.

Product Advantages

- Easy-to-Use** | Ease of operation due to the low friction design
 The short levers may be repositioned and exchanged
 Extremely compact
 Wide range of configurations
- Maximum Efficiency** | Excellent performance under vacuum
 Full flow
 Chemical nickel-plated brass with high phosphorous content for outstanding corrosion resistance
 Automatic seal wear compensation system
- Reliability** | Tried-and-tested technology
 Forged brass provides mechanical strength and long service life
 100% leak-tested in production
 Date coding to guarantee quality and traceability



- Applications**
- Vacuum
 - Transportation
 - Packaging
 - Textile
 - Pneumatics
 - Sawmills
 - Rubber & Plastics

Technical Characteristics

Compatible Fluids	Compressed air Other fluids: see compatibility chart at the end of this chapter
Working Pressure	Vacuum to 12 bar
Working Temperature	-20°C to +80°C

Tightening Torques	Threads	G1/8	G1/4	G3/8	G1/2	G3/4
	daN.m	0.10 to 0.20	0.10 to 0.20	0.15 to 0.25	0.20 to 0.35	0.50 to 0.70

Reliable performance is dependent upon the type of fluid conveyed, component materials and tubing being used.
 Guaranteed for use with a vacuum of 755 mm Hg (99% vacuum).

Component Materials

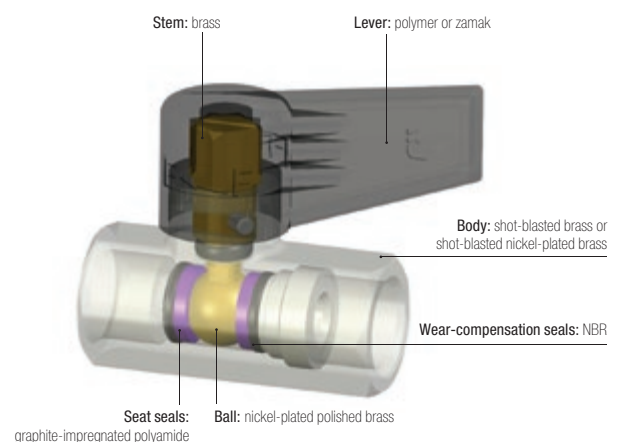

Silicone-free

Regulations

- DI: 97/23/EC (module PED A - diameters greater than 25 mm)
- DI: 2006/42/EC (Machinery Directive)
- DI: 2002/95/EC (RoHS)
- RG: 1907/2006 (REACH)

Universal Light Series

0492

2/2 In-Line Ball Valve, Female BSPP Thread

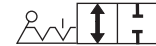

Nickel-plated brass, NBR

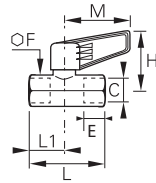

DN	C		E	F	H	L	L1	M	Kg
4	G1/4	0492 04 13	9	17	34	39.5	17	35	0.073
7	G3/8	0492 07 17	11	22	38	45	20	43	0.128
10	G1/2	0492 10 21	12	24	44	54	25	50	0.162
13	G3/4	0492 13 27	14	30	46	62	28	50	0.240

Technical polymer handle

0492..64

2/2 In-Line Ball Valve, Short Handle, Female BSPP Thread



Nickel-plated brass, NBR

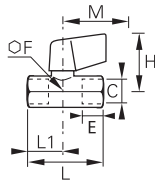

DN	C		E	F	H	L	L1	M	Kg
4	G1/4	0492 04 13 64	9	17	36	39.5	17	25	0.090

*Short handle in zamac

0491

2/2 In-Line Ball Valve, Male/Female BSPP Thread



Nickel-plated brass, NBR

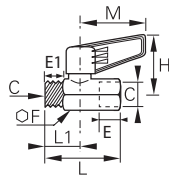

DN	C		E	E1	F	H	L	L1	M	Kg
4	G1/4	0491 04 13	9	7	17	34	39.5	17	35	0.070
7	G3/8	0491 07 17	11	8	22	38	45	20	43	0.124
10	G1/2	0491 10 21	12	10	24	44	53	24	50	0.160
13	G3/4	0491 13 27	14	12	30	46	59	25	50	0.238

Technical polymer handle

0491..64

2/2 In-Line Ball Valve, Short Handle, Male/Female BSPP Thread



Nickel-plated brass, NBR

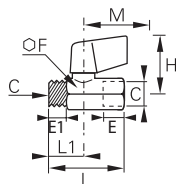

DN	C		E	E1	F	H	L	L1	M	Kg
4	G1/4	0491 04 13 64	9	7	17	36	39.5	17	25	0.092

*Short handle in zamac

0490

2/2 In-Line Ball Valve, Male BSPP Thread



Nickel-plated brass, NBR

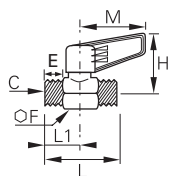

DN	C		E	F	H	L	L1	M	Kg
4	G1/4	0490 04 13	7	17	34	39	17	35	0.070
7	G3/8	0490 07 17	8	22	38	44	20	43	0.109
10	G1/2	0490 10 21	10	24	44	53	24	50	0.160
13	G3/4	0490 13 27	12	30	46	59	25	50	0.233

Technical polymer handle

Universal Light Series

0494 2/2 In-Line Ball Valve, 2 Vent Plugs, Female BSPP Thread

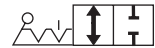

Nickel-plated brass, NBR

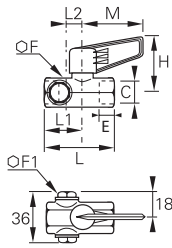

DN	C		E	F	F1	H	L	L1	L2	M	Kg
7	G3/8	0494 07 17	11	22	16	38	60	20	15	43	0.178

Technical polymer handle

0497 2/2 Ball Valve, Square Stem, Female BSPP Thread

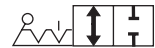

Brass, NBR

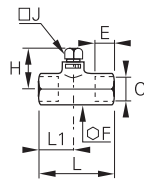

DN	C		E	F	H	J	L	L1	Kg
4	G1/4	0497 04 13	9	17	25	7	39	17	0.063
7	G3/8	0497 07 17	11	22	26	7	45	20	0.122
10	G1/2	0497 10 21	12	24	29	10	54	25	0.141
13	G3/4	0497 13 27	14	30	30	10	62	28	0.230

0496 2/2 Ball Valve, Square Stem, Male/Female BSPP Thread

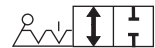

Brass, NBR

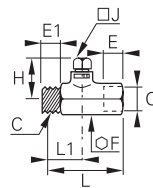

DN	C		E	E1	F	H	J	L	L1	Kg
4	G1/4	0496 04 13	7	9	17	25	7	39	17	0.065
7	G3/8	0496 07 17	8	11	22	26	7	45	20	0.118
10	G1/2	0496 10 21	10	12	24	29	10	53	24	0.150
13	G3/4	0496 13 27	12	14	30	30	10	59	28	0.222



Ball Valves

Industrial Valves

Ball Valves, DVGW Series

The combination of long threads, a reinforced sealing system and **DVGW** certification makes this valve perfect for the **transmission of gas and water**.

Product Advantages

Reliability & Sealing

Stem prevented from being ejected in the event of overpressure
Two stem seals to prevent leakage
Date coding to guarantee quality and traceability

Optimum Performance

Full flow minimises pressure drop
Nickel-plated brass provides improved corrosion resistance and increased chemical compatibility
Can be operated at very low temperatures (-50°C)

Long Threads

Excellent fitting compatibility:
• dimensions compliant with DIN 3357
• BSP threads compliant with DIN 2999/ISO 228



Applications
Robotics
Pneumatics
Water & Gas Handling
Machine Tools
Textile
Wood Industry

Technical Characteristics

Compatible Fluids	Compressed air, water, gas
Working Pressure	1/4" to 2": 0 to 40 bar
Working Temperature	-50°C to +170°C

Reliable performance is dependent upon the type of fluid conveyed. Products have been tested at -50°C in static sealing and after 5 operations for a leak rate < 0,05NI/h.

Component Materials

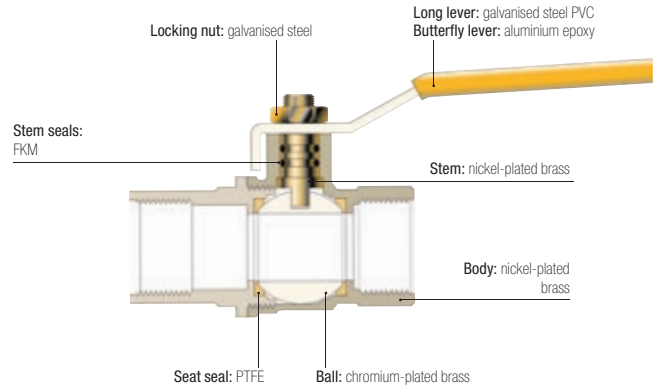

Silicone-free

Working Pressure and Temperature

Pressure - Temperature

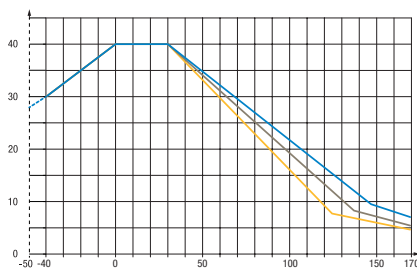

Pressure Drop

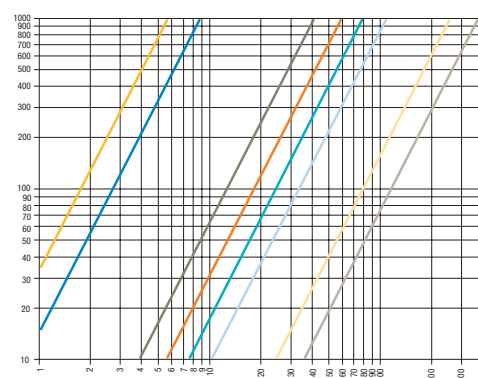

Regulations

Industrial
DI: 97/23/EC
(PED B+D module EC 1115)
Water
DVGW: W 570-1
DIN EN 13228
BGA KTW
DVGW: W270
Gas
DIN EN 33

DVGW Series

BVG4-L

2/2 In-Line Ball Valve, Female BSPP Thread



Nickel-plated brass

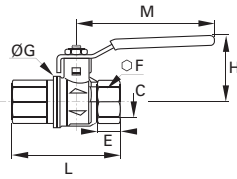

DN	C		E	F	G	H	L	M	Kg
8	G1/4	BVG4-1/4L	12	20	25	38	50	82	0.150
10	G3/8	BVG4-3/8L	12	20	25	38	60	82	0.150
15	G1/2	BVG4-1/2L	15.5	25	32.5	43	75	100	0.255
20	G3/4	BVG4-3/4L	17	32	39	50	80	120	0.390
25	G1	BVG4-1L	21	41	47.5	54	90	120	0.590
32	G1 1/4	BVG4-1.1/4L	23	50	59	73	110	158	0.980
40	G1 1/2	BVG4-1.1/2L	23	55	71.5	79	120	158	1.205
50	G2	BVG4-2L	26.5	70	86	86	140	158	1.960

BVGT4-L

2/2 In-Line Ball Valve, Female BSPP Thread



Nickel-plated brass

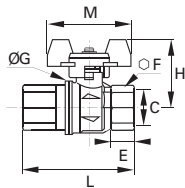

DN	C		E	F	G	H	L	M	Kg
8	G1/4	BVGT4-1/4L	12	20	25	39	50	50	0.150
10	G3/8	BVGT4-3/8L	12	20	25	39	60	50	0.150
15	G1/2	BVGT4-1/2L	15.5	25	32.5	43	75	50	0.230
20	G3/4	BVGT4-3/4L	17	32	39	47	80	60	0.350
25	G1	BVGT4-1L	21	41	47.5	51	90	60	0.550

Compact lever

Ball Valves, Standard Series

This range of valves with **fluoropolymer seals**, available in compact, standard and lockable series, covers many **industrial applications** for which the fluids conveyed and working temperatures require this seal material.

Product Advantages

Optimised Installation

- Full fluid flow
- Long or butterfly lever
- Corrosion resistance
- A lockable version for operational safety
- Good value/performance ratio

Wide Compatibility

- Numerous compatible fluids
- Can be used for low and medium pressure applications
- Surface treatment for corrosion protection



Applications

- Machine Tool
- Agricultural Machinery
- Textile
- Pneumatics
- Plumbing
- Air Conditioning
- Heating

Technical Characteristics

Model	Standard and Lockable Series	Compact Series
Compatible Fluids	Compressed air, gas, water, water vapour, oil and all fluids compatible with the component materials	
Working Pressure	0 to 30 bar	0 to 35 bar
Working Temperature	-20°C to +130°C	-10°C to +90°C

Reliable performance is dependent upon the type of fluid conveyed.

Component Materials

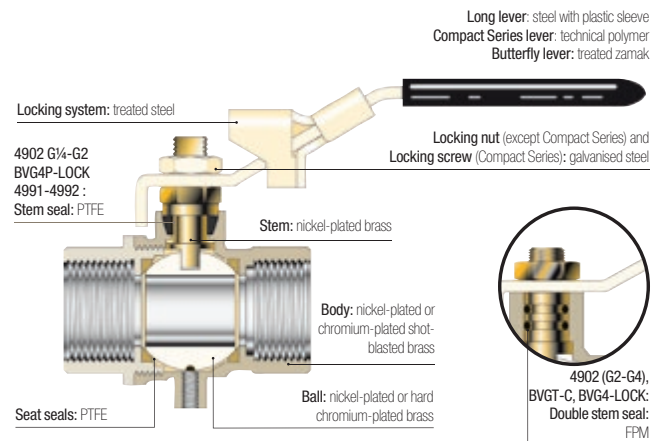

Silicone-free

Regulations

Industrial

DI: 97/23/EC (module PED A - EC diameters greater than 25 mm)

DI: Machinery Directive 2006/42/EC

DI: 2002/95/EC (RoHS)

RG: 1907/2006 (REACH)

DI: 89/392/EC

Standard Series

4902

2/2 Standard In-Line Ball Valve, Female BSPP Thread



Nickel-plated brass, PTFE

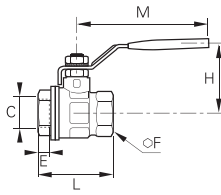

DN	C		E	F	H	L	M	Kg
10	G1/4	4902 10 13	11	20	43	51.5	98	0.154
	G3/8	4902 10 17	11	20	43	51.5	98	0.138
15	G1/2	4902 15 21	13.5	25	47	55	98	0.204
20	G3/4	4902 20 27	12.5	31	58	57.5	122	0.322
25	G1	4902 25 34	15	38	60	69.5	122	0.468
32	G1 1/4	4902 32 42*	17	48	77	81.5	153	0.794
40	G1 1/2	4902 40 49*	18	54	83	95	153	1.082
50	G2	4902 50 48*	22	66	95	113	162	1.787
65	G2 1/2	4902 65 47*	22	85	132	136	255	4.500
80	G3	4902 80 46*	25	99	140	157	255	5.840
100	G4	4902 01 45*	29	125	154	191	255	9.040

*Models with EC marking

Model from 2 1/2": double stem seal in FPM

Working temperature: -40°C to +170°C (en pointe)

4991

2/2 Standard Compact In-Line Ball Valve, Male/Female BSPP Thread



Chromium-plated brass, PTFE

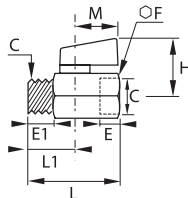

DN	C		E	E1	F	H	L	L1	M	Kg
6	G1/8	4991 00 10	10	10	21	30	41.5	10	24	0.089
	G1/4	4991 00 13	11	11	21	30	41.5	11	24	0.082
8	G3/8	4991 00 17	11	11	21	30	41.5	10.5	24	0.087
	G1/2	4991 00 21	13	13	25	32	49	12.5	24	0.134

4992

2/2 Standard Compact In-Line Ball Valve, Female BSPP Thread



Chromium-plated brass, PTFE

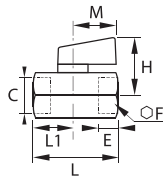

DN	C		E	F	H	L	L1	M	Kg
6	G1/8	4992 00 10	10	21	30	41.5	10	24	0.110
	G1/4	4992 00 13	11	21	30	41.5	11	24	0.106
8	G3/8	4992 00 17	11	21	30	41.5	10.5	24	0.094
	G1/2	4992 00 21	13	25	32	49	12.5	24	0.142

BVGT4-C

2/2 Standard In-Line Ball Valve, Female BSPP Thread



Nickel-plated brass

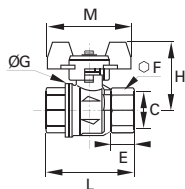

DN	C		E	F	G	H	L	M	Kg
8	G1/4	BVGT4-1/4C	9	20	25	40	39	50	0.130
10	G3/8	BVGT4-3/8C	9	20	25	40	39	50	0.120
15	G1/2	BVGT4-1/2C	11	25	32.5	44	50	50	0.180
20	G3/4	BVGT4-3/4C	12	31	39	49	54	50	0.265
25	G1	BVGT4-1C	14	38	47.5	53	67	50	0.390

Compact lever

Standard Series

BVG4-LOCK

2/2 In-Line Lockable Ball Valve, Female BSPP Thread



Nickel-plated brass

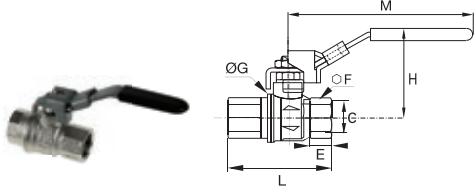

DN	C		E	F	ØG	H	L	M	Kg
8	G1/4	BVG4-1/4LOCK	12	20	25	38	50	82	0.150
10	G3/8	BVG4-3/8LOCK	12	20	25	38	60	82	0.150
15	G1/2	BVG4-1/2LOCK	15.5	25	32.5	43	75	100	0.255
20	G3/4	BVG4-3/4LOCK	17	32	39	50	80	120	0.390
25	G1	BVG4-1LOCK	21	41	47.5	54	90	120	0.590

Double stem seal in FPM
Working temperature: -40°C to +170°C

BVG4P-LOCK

3/2 In-Line Lockable Vented Ball Valve, Female BSPP Thread



Nickel-plated brass

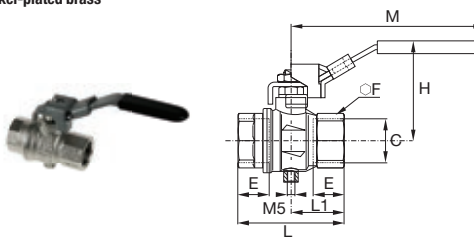

DN	C		E	F	H	L	L1	M	Kg
8	G1/4	BVG4P-1/4LOCK	12	20	47.5	45	22.5	96	0.155
10	G3/8	BVG4P-3/8LOCK	12	20	47.5	45	22.5	96	0.172
15	G1/2	BVG4P-1/2LOCK	15.5	25	52	59	29.5	96	0.239
20	G3/4	BVG4P-3/4LOCK	17	31	59.5	64	32	117	0.371
25	G1	BVG4P-1LOCK	21	40	63.5	81	40.5	117	0.581

Working pressure: 14 bar
Working temperature: -10°C to +100°C

Ball Valves: Usage Chart

The chart below shows the compatibility between valves and fluids along with their pressure and temperature characteristics.

Certain models have a maximum working pressure which differs from that given in this table. In this case, the pressure is shown in the heading for the model number in question.

N.B.: Above 32 mm or 1¼" diameters, divide the maximum pressure by 2.

If the fluid you are using is not shown in this chart, please contact us.

Chemical Description	Maximum Pressure (bar)	Temperature °C		Universal and Light Series	Standard Series	DVGW series	Customised Series							
		Min.	Max.				20	22	26	27	30	32		
"Aromatic" hydrocarbons	20	-20	+60					●						
Acetone and other ketones	20	-20	+60											●
Acetophenone	20	-20	+60											●
Acetylene - Acetone	20	-20	+60											●
Acetylene (gas)	20	-20	+60	●	●	●								
Alcohol (100%)	20	-20	Boiling											●
Aluminium (liquid suspension, thick)	40	-20	+90	●	●	●								
Amyl alcohol	20	-20	Boiling											●
Animal fats, greases	20	+5	+200		●	●			●					
Antifreeze or glycol (diluted)	40	-20	+40	●	●	●								
Argon (gas) Ar	20	-20	+60	●	●	●								
Barium - Hydroxide	20	-20	+40											●
Benzaldehyde	20	-20	+60											●
Benzene	20	-20	+60					●						
Benzyl alcohol	20	-20	Boiling					●						
Borax (pastes or solutions)	20	-20	+60											●
Brake fluids (automobile)	20	-20	+90											●
Bromochlorotrifluorethane	20	-20	+60		●	●			●					
Butadiene (hydrocarbon)	20	-20	+60									●		
Butane	20	-20	+60	●	●	●								
Butanol	20	-20	Boiling					●						
Butyl alcohol	20	-20	Boiling					●						
Butylene (hydrocarbon)	20	-20	+60					●						
Carbon dioxide gas CO ₂	40	-20	+60	●	●									
Castor oil	40	-20	+90	●	●									
Compressed air	20	-25	+180	●	●	●	●	●	●	●	●	●	●	●
Creosotes	20	-20	+60									●		
Cresols	20	-20	+60									●		
Crude oil	20	-20	+40				●							
Cutting oil	40	-20	+90	●	●									
Decalin (hydrocarbon, solvent)	20	-20	+60									●		
Detergents (solutions)	20	-20	+100											●
Diacetone alcohol	20	-20	Boiling											●
Diesel oils	40	-20	+90	●	●									
Di-Esters	20	-20	+90					●						
Di-Isobutylene	20	-20	+60									●		
Di-Pentane	20	-20	+60					●						

The above recommendations are given in good faith. However, since each application is different, it is advisable to undertake tests in actual working conditions.

Ball Valves: Usage Chart

Chemical Description	Max. Pressure (bar)	Temperature °C		Universal and Light Series	Standard Series	DVGW Series	Customised Series						
		Min.	Max.				20	22	26	27	30	32	
Di-Pentene (solvents, varnish)	20	-20	+60					●					
Di-Phenyl-Oxide (thin detergents)	20	-20	+60								●		
Distilled water	40		+90	●	●	●							
Edible fats	20	+5	+200		●					●			
Edible oils	20	+5	+200		●					●			
Erytrene (see Butadiene)	20	-20	+60								●		
Ethane (gas) CH ₂ CH ₃	20	-20	+60	●	●								
Ethane (hydrocarbon gas)	20	-20	+60								●		
Ethyl alcohol	20	-20	+60										●
Ethylene glycol (antifreeze) - see Glycols	20	-20	+120										●
Fatty alcohols	20	-20	Boiling					●					
Fuel oils	40	-20	+40	●	●	●							
Fuels-Diesels	40	-20	+40	●	●								
Gaseous oxygen (ambient air)	20	-20	+40										●
Glycerine	20	-20	+40	●	●								
Glycol (for antifreeze, lubricants)	40	-20	+40	●	●								
Graphite in suspension in water, oils and greases	40	-20	+90	●	●								
Greases (from petroleum)	40	-20	+90	●	●								
Helium (gas)	20	-20	+60										●
Heptanal	20	-20	+50	●	●								
Hexane (solvent)	20	-20	+60										●
Hydraulic oils (petroleum-based)	40	-20	+90	●	●								
Hydrogen (gas)	20	-20	+60										●
Inks	20	-20	+60									●	
Insecticides	20	0	+40	●	●	●							
Iso-Butane (aliphatic hydrocarbon)	20	-20	+60									●	
Iso-Octane	20	-20	+60									●	
Isopropyl alcohol	20	-20	Boiling										●
Krypton (gas) Kr	20	-20	+60	●	●	●							
Light water	40		+80	●	●	●							
Lighting gas	20	-20	+40			●							
Methane (gas) CH ₄	20	-20	+60	●	●	●							
Methanol	20	-20	Boiling										●
Methyl alcohol	20	-20	Boiling										●
Methylated spirit	40	-20	+40	●	●	●							
Mineral oils	40	-20	+90	●	●								
Natural gas	20	-20	+40			●							
Natural waxes (vegetable, beeswax, carnauba, Chinese, lignite)	40	-20	+90									●	
Neatsfoot oil	40	-20	+90	●	●	●							
Neon (Gas) Ne	20	-20	+60	●	●	●							
Nitrogen (gas) N ²	40	-20	+90	●	●	●							
Oil (petroleum-based) and water emulsions	40	-20	+90	●	●	●							

The above recommendations are given in good faith. However, since each application is different, it is advisable to undertake tests in actual working conditions.

Ball Valves: Usage Chart

Chemical Description	Max. Pressure (bar)	Temperature °C		Universal and Light Series	Standard Series	DVGW Series	Customised Series								
		Min.	Max.				20	22	26	27	30	32			
Oils "synthetic"	20	-20	+100												●
Ordinary petrol	20	-20	+40	●	●										
Oxygenated water	40	-20	+30				●								
Paints and relevant solvents	20	-20	+60		●	●				●					
Paraffin oil	40	-20	+90	●	●	●									
Paraffins	20	-20	+60	●	●	●									
Pentane (liquid hydrocarbon)	20	-20	+60	●	●	●									
Pentanol 1 and 2	20	-20	Boiling												●
Petrol "super"	20	-20	+40				●								
Petroleum mineral oils	20	-20	+160						●						
Phenol (aqueous or alcoholic)	20	-20	+60		●	●				●					
Propane	20	-20	+60	●	●	●									
Propanol 1 and 2	20	-20	Boiling												●
Propanone 2	20	-20	+60												●
Propene or Propylene	20	-20	+60						●						
Propyl alcohol	20	-20	Boiling												●
Propylene or Propene	20	-20	+60						●						
Rapeseed oil	40	-20	+90	●	●										
Saponifying liquids	20	-20	+30	●	●	●									
Seawater	40		+80	●	●	●									
Seawater (high temperature)	20		+150			●						●			
Soaps	20	-20	+100												●
Soaps (liquid or paste)	40	-20	+40	●	●	●									
Sodium carbonate (with water)	20	0	+40	●	●	●									
Starch (gels or pastes)	40	+10	+40	●	●	●									
Steam	20	-20	+150												●
Toluene (terpenic hydrocarbon)	20	-20	+60		●	●				●					
Trichlorethylene	20	-20	+65						●						
Turpentine	20	-20	+50	●	●	●									
Varnish and paints	20	-20	+60		●	●				●					
Vaseline	40	-20	+60	●	●	●									
Vaseline oil	40	-20	+90	●	●	●									
Water (carbonated)	40		+90	●	●	●									
Water (high temperature)	20		+150			●									●
Xenon (gas) Xe	20	-20	+60	●	●	●									
Xylene	20	-20	+60						●						

The above recommendations are given in good faith. However, since each application is different, it is advisable to undertake tests in actual working conditions.

Ball Valves, Stainless Steel Series

Stainless steel series ball valves can withstand **corrosive fluids** and **environments**.

With full flow, high pressure and temperature capabilities, these valves are suitable for many applications.

Product Advantages

Reliability

- Full flow
- Excellent chemical compatibility
- High resistance to pressure/temperature
- Light series version: 100% leak-tested in production, date coding to guarantee quality and traceability

Versatility

Three in-line versions:

- One-piece: cannot be disassembled
- 3-piece: easily disassembled for maintenance and cleaning
- Light Series: for maximum compactness

Fixing plate: 4812 and 4832

- Through-bulkhead fitting
- Pneumatic or electronic actuation (ISO 5211 standard)



Applications

- Food Process
- Aviation
- Chemical
- Semi-Conductors
- Medical
- Petrochemical
- Laboratories
- Pharmaceutical

Technical Characteristics

Compatible Fluids	Type 4810, 4812 and 4832	Type 0465
	All fluids	All fluids
Working Pressure	0 to 65 bar	Vacuum to 20 bar
Working Temperature	-20°C to +150°C	-20°C to +120°C

Reliable performance is dependent upon the type of fluid conveyed, component materials and tubing being used. Guaranteed for use with a vacuum of 755 mm Hg (99% vacuum).

Component Materials

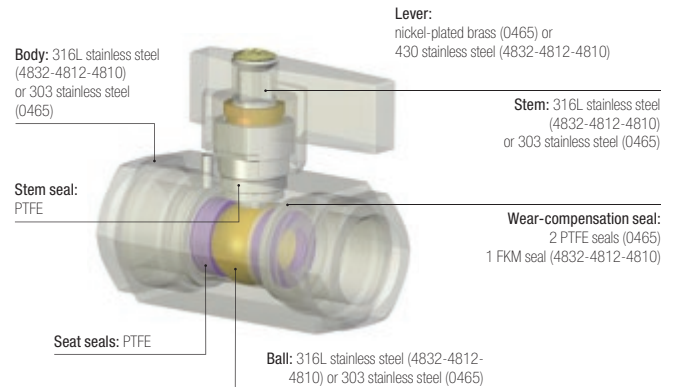

Pressure and Temperature Resistance

Version 4810, 4812 and 4832

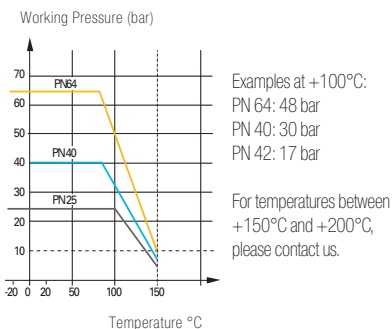

Version 0465

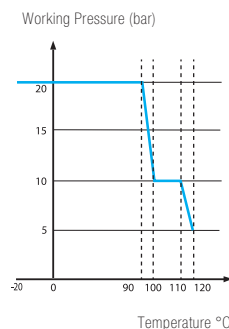

Regulations

Industrial

DI: 97/23/EC (module PED A - EC diameters greater than 25 mm)
DI: Machinery Directive 2006/42/EC
DI: 2002/95/EC (RoHS)
RG: 1907/2006 (REACH)
DI: 89/392/EC

Stainless Steel Series

4832 2/2 In-Line 3-Piece Ball Valve with Fixing Plate, Female BSPP Thread



Stainless steel 316L, PTFE

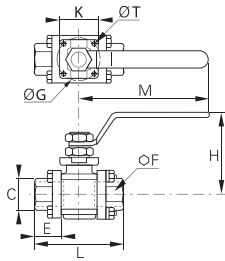

DN	C		E	F	G	H	K	L	M	ØT	Kg
10	G1/4	4832 10 13	18	22	36	50	36	57	110.5	5.5	0.272
	G3/8	4832 10 17	18	22	36	50	36	57	110.5	5.5	0.400
15	G1/2	4832 15 21	20.5	27	36	64	36	65	131.5	6	0.442
20	G3/4	4832 20 27	22.5	32	42	68	42	76	131.5	5.5	0.568
25	G1	4832 25 34	27	41	42	78.5	42	92	174.5	6	1.035
32	G1 1/4	4832 32 42*	30	50	42	83.5	42	106.5	174.5	5.5	1.530
40	G1 1/2	4832 40 49*	31	55	50	100	50	116	250.5	6.5	2.146
50	G2	4832 50 48*	36	70	50	107	50	136	250.5	6.5	3.140

*Models with EC marking

4812 2/2 In-Line Ball Valve with Fixing Plate, Female BSPP Thread



Stainless steel 316L, PTFE

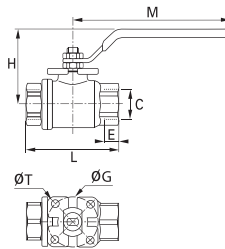

DN	C		E	G	H	L	M	ØT	Kg
10	G1/4	4812 10 13	10	36	50	55	110	5.5	0.263
	G3/8	4812 10 17	11	36	50	55	110	5.5	0.254
15	G1/2	4812 15 21	15	36	53	66	110	5.5	0.336
20	G3/4	4812 20 27	16	42	67	79	130	5.5	0.574
25	G1	4812 25 34	19	42	79	93	175	5.5	1.000
32	G1 1/4	4812 32 42*	21	42	83	100	175	5.5	1.337
40	G1 1/2	4812 40 49*	21	50	100	110	250	5.5	2.214
50	G2	4812 50 48*	26	70	107	131	250	8.5	3.262

*Models with EC marking

4810 2/2 In-Line Ball Valve, Female BSPP Thread

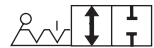

Stainless steel 316L, PTFE

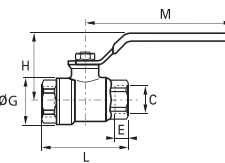

DN	C		E	G	H	L	M	Kg
8	G1/4	4810 08 13	10	30	44.5	53.5	110.5	0.205
10	G3/8	4810 10 17	10	30	44.5	53.5	110.5	0.194
15	G1/2	4810 15 21	13	32.5	47	60	110.5	0.245
20	G3/4	4810 20 27	14	40	54.5	70	131.5	0.420
25	G1	4810 25 34	17	49	58.5	79	131.5	0.648

Threads conform to ISO 228-1

0465 2/2 In-Line Light Series Ball Valve, Female BSPP Thread

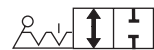

Stainless steel 303, PTFE

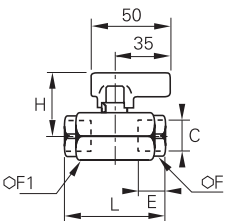

DN	C		E	F	F1	H	L	Kg
4	G1/4	0465 04 13	13	19	24	36	50	0.226
7	G3/8	0465 07 17	13	24	27	39	55	0.278
10	G1/2	0465 10 21	16	27	30	40	62	0.322

Silicone-free

Ball Valves, High Pressure Series

These valves are suitable for **applications** with pressures **up to 300 bar**. High performance materials and quality manufacturing allow for a wide range of operating pressures and temperatures.

Product Advantages

High Pressure & Safety

Good sealing at low and high pressure
Robust design with secure, non-removable inlet and outlet ports
Forged brass providing excellent long-term strength under severe conditions of use
100% leak-tested in production
Date coding to guarantee quality and traceability

Easy-to-Use

Fixing screws for through-bulkhead mounting
The lever may be repositioned or replaced with a handwheel
Low operating torque



Automotive Process
Foundry
Forming
Machine Tools
Textile
Spectacle-Making Industry
Turbines
Deep-Sea Diving

Applications

Technical Characteristics

Compatible Fluids	Compressed air
Working Pressure	Vacuum to 300 bar
Working Temperature	-15°C to +80°C

Reliable performance is dependent upon the type of fluid conveyed, component materials and tubing being used.
Guaranteed for use with a vacuum of 755 mm Hg (99% vacuum).

Component Materials

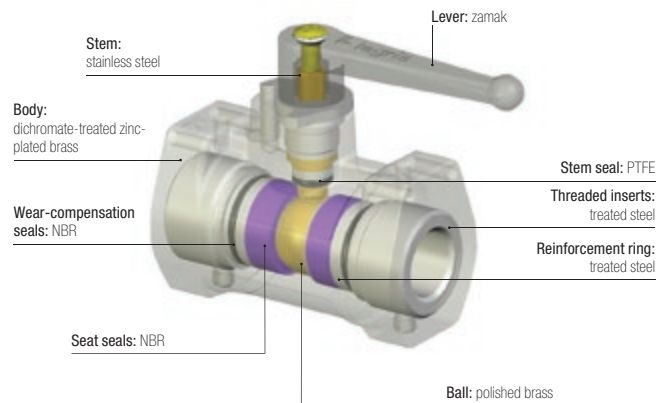

Silicone-free

Regulations

DI: 97/23/EC (module PED A - diameters greater than 25 mm)
DI: 2006/42/EC (Machinery Directive)
DI: 2002/95/EC (RoHS)
RG: 1907/2006 (REACH)

Installation Options

Bulkhead Mounting

Through bulkhead with screws

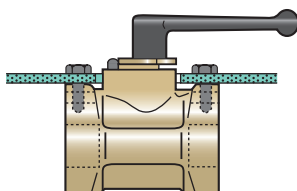

Surface Mounting

With brackets and screws

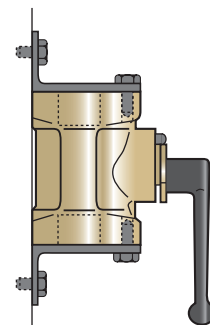

High Pressure Series

4402

2/2 In-Line High Pressure Ball Valve, Female BSPP Thread

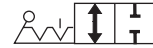

Treated brass, NBR

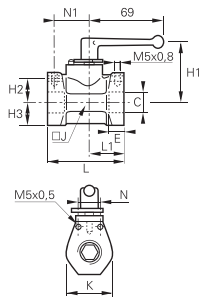

DN	C		E	H1	H2	H3	J	K	L	L1	N	N1	Kg
7	G1/4	4402 07 13	12	50	13	15	30	30	58	25	15	20	0.402
10	G3/8	4402 10 17	12	54	23	19	36	39	72	36	20	30	0.722
13	G1/2	4402 13 21	15	56	23	21	40	42	79	36	20	30	0.870

Ball Valves, Mini Series

With their **push-in connections**, these polymer lightweight ball valves allow for a significant reduction in installation time while offering **full flow capability** and **compact dimensions**.

Product Advantages

Optimum Solution

- Full flow
- Marked with the pneumatic symbol for identification of its function
- Lightweight and compact
- Extremely compact, easy-to-operate lever
- Lever with screwdriver slot to facilitate operation
- Designed for polymer tubing with no tube preparation
- Can be mounted on a wall or adjacent using staples



Proven Technology

- LF 3000® push-in connection, excellent static and dynamic sealing
- High-strength polyamide
- Excellent long-term performance
- Automatic seal wear compensation for long-term reliability
- 100% leak-tested in production
- Date coding to guarantee quality and traceability

Applications

- Robotics
- Vacuum
- Semi-Conductors
- Packaging
- Textile
- Pneumatics

Technical Characteristics

Compatible Fluids	Compressed air			
Working Pressure	Vacuum to 10 bar			
Working Temperature	-20°C to +80°C			

Tightening Torques	Threads	G1/8	G1/4	G3/8	G1/2
	daN.m	0.8	1.2	3	3.5

Reliable performance is dependent upon the type of fluid conveyed, component materials and tubing being used.
Guaranteed for use with a vacuum of 755 mm Hg (99 % vacuum).

Component Materials

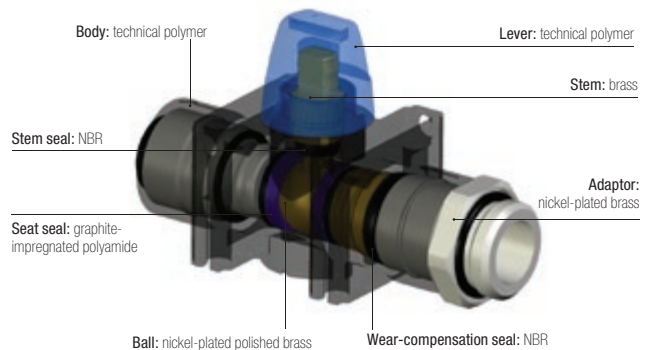

Silicone-free

Operation

Vented Valve, Open Position

3/2 model with vent

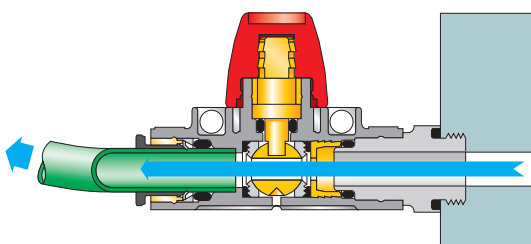

Vented Valve, Closed Position

Lever with screwdriver slot

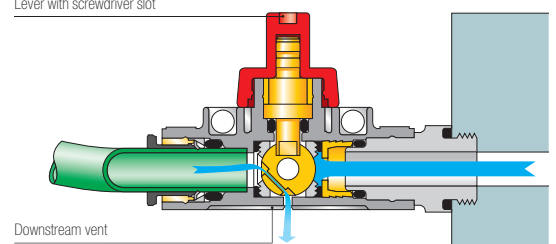

Mini Series

7910 2/2 In-Line Mini-Ball Valve



Technical polymer, NBR

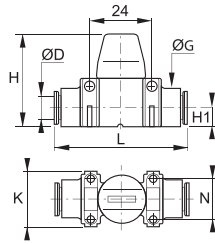

ØD		G	H	H1	K	L	N	Kg
4	7910 04 00	15	37	7.5	22	51	16	0.039
6	7910 06 00	15	37	7.5	22	52	16	0.034
8	7910 08 00	15	37	7.5	22	52	16	0.025
10	7910 10 00	20	43	11	30	66	22	0.060
12	7910 12 00	20	43	11	30	66	22	0.040

7911 2/2 In-Line Mini-Ball Valve, Male BSPP Thread



Technical polymer, nickel-plated brass, NBR

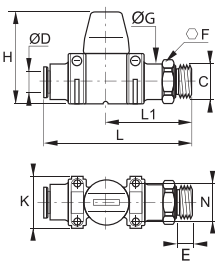

ØD	C		E	F	G	H	K	L	L1	N	Kg
6	G1/8	7911 06 10	5	13	14	37	22	62	37	16	0.045
8	G1/4	7911 08 13	5.5	16	17.5	37	22	61	35	16	0.040
10	G3/8	7911 10 17	5.5	20	22	43	30	74	41	22	0.075
12	G1/2	7911 12 21	7.5	24	26	43	30	75	42	22	0.075

7913 3/2 In-Line Mini-Ball Valve with Vent

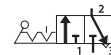

Technical polymer, NBR

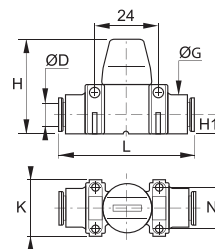

ØD		G	H	H1	K	L	N	Kg
4	7913 04 00	15	37	7.5	22	51	16	0.040
6	7913 06 00	15	37	7.5	22	52	16	0.035
8	7913 08 00	15	37	7.5	22	52	16	0.025
10	7913 10 00	20	43	11	30	66	22	0.060
12	7913 12 00	20	43	11	30	66	22	0.045

7914 3/2 In-Line Mini-Ball Valve with Vent, Male BSPP Thread



Technical polymer, nickel-plated brass, NBR

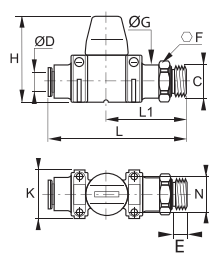

ØD	C		E	F	G	H	K	L	L1	N	Kg
6	G1/8	7914 06 10	5	13	14	37	22	62	37	16	0.045
8	G1/4	7914 08 13	5.5	16	17.5	37	22	61	35	16	0.040
10	G3/8	7914 10 17	5.5	20	22	43	30	74	41	22	0.058
12	G1/2	7914 12 21	7.5	24	26	43	30	75	42	22	0.075

7000 Joining Clips

Technical polymer



ØD		Kg
4	7000 00 05	0.005
6	7000 00 05	0.005
8	7000 00 05	0.005
10	7000 00 06	0.009
12	7000 00 06	0.009

LIQUIfit® Ball Valves

This range of valves offers an innovative solution in the treatment of **water and the handling of beverages** while protecting **health**. These **compact and reliable** valves offer perfect **sealing** and excellent **cleanliness**.

Product Advantages

Innovative Technology & Increased Reliability

- Full flow to limit turbulence
- Full-flow self-cleaning ball maintains the cleanliness of the circuit
- Tube retention with gripping ring prevents pumping effect
- Push-in connection and disconnection
- Sealing technology using patented EPDM seal

High Performance

- Inert technical polymer providing the best mechanical strength, thermal and chemical resistance
- Carstick® connection providing resistance to water hammer
- Other configurations available on request



Beverage Dispensers
Inert Gases
Cooling
Food Process
Water Purification
Water Coolers

Applications

Technical Characteristics

Compatible Fluids	Water, drinks, beverages			
Working Pressure	0 to 10 bar at 20°C			
Working Temperature	-15°C to +100°C			
Tightening Torques	Threads	1/4" NPTF	3/8" NPTF	1/2" NPTF
	daN.m	1.5	3	3

Component Materials

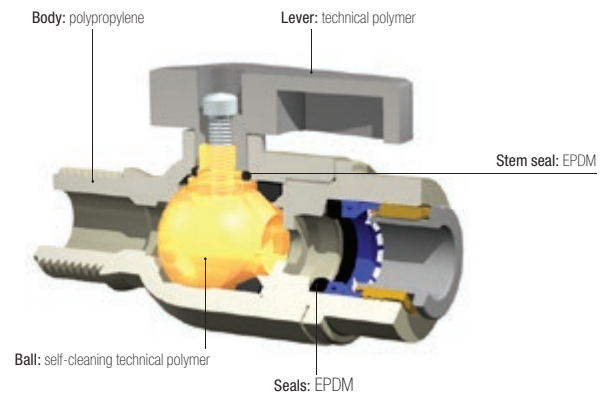

Silicone-free

Regulations

FDA: 21 CFR
NSF: 51 and lead < 0.25%
WQA: Water Quality Association

4020 2/2 In-Line Ball Valve



Polypropylene with fibreglass, EPDM

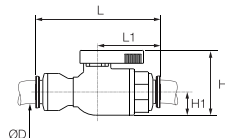

ØD		H	H1	L	L1	Kg
6	4020 06 00WP2	36	13	57	27	0.019
8	4020 08 00WP2	36	13	60	27	0.020
10	4020 10 00WP2	36	13	70	33	0.023
12	4020 12 00WP2	36.5	13	88	43	0.034

4020 2/2 In-Line Ball Valve

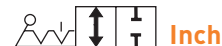

Polypropylene with fibreglass, EPDM

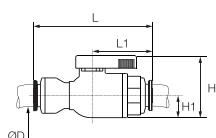

ØD		H	H1	L	L1	Kg
1/4	4020 56 00WP2	25	13	65	31	0.025
3/8	4020 60 00WP2	36	13	68	30.5	0.034

4021 2/2 In-Line Ball Valve, Male NPTF Thread

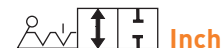

Polypropylene with fibreglass, EPDM

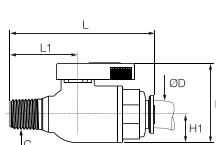

ØD	C		H	H1	L	L1	Kg
1/4	NPTF1/4	4021 56 14WP2	36	13	61	31	0.029
3/8	NPTF3/8	4021 60 18WP2	36	13	64	33.5	0.028

4023 2/2 In-Line Ball Valve, Female NPTF Thread



Polypropylene with fibreglass, EPDM

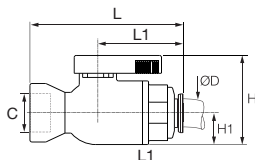

ØD	C		H	H1	L	L1	Kg
1/4	NPTF1/4	4023 56 14WP2	36	13	58	31	0.025
3/8	NPTF3/8	4023 60 18WP2	36	13	64	33.5	0.028

4022 2/2 Right- Angled Ball Valve, Female NPTF Thread



Polypropylene with fibreglass, EPDM

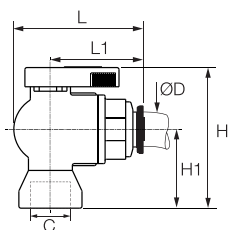

ØD	C		H	H1	L	L1	Kg
1/4	NPTF1/4	4022 56 14WP2	52	29	44	31	0.026
3/8	NPTF3/8	4022 60 18WP2	52	29	47	33.5	0.031

4024 2/2 Right- Angled Ball Valve



Polypropylene with fibreglass, EPDM

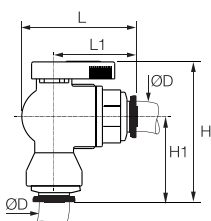

ØD		H	H1	L	L1	Kg
6	4024 06 00WP2	54	31	41	27	0.020
8	4024 08 00WP2	56	33	41	27.5	0.020
10	4024 10 00WP2	61	38	47	33	0.024
12	4024 12 00WP2	63	40	57	43	0.031

Needle and Butterfly Valve Range

Brass Needle Valves

In-Line

0502
Page 6-39

0501
Page 6-39

0510
Page 6-39



Right-Angled

0532
Page 6-39

0531
Page 6-39



Drain Valve

0562
BSPP/Metric
Page 6-40

0563
NPT
Page 6-40



Venting Pressure Gauge Valve

0627
BSPP
Page 6-40



Pressure Relief Valve

0630
BSPP
Page 6-40



Stainless Steel Needle Valve

In-Line

0591
Page 6-41



Butterfly Valve

In-Line

4602
Page 6-43



Needle Valves

Parker Legris compact needle valves can be installed in any system and are designed for applications requiring accurate **leak-free fluid control** and **excellent service life**.

Product Advantages

- Robust and Easy-to-Use**
 - Accurate flow control
 - Forged brass for improved long-term mechanical strength
 - Robust stem for good operational reliability
 - Corrosion resistance
- Wide Range**
 - Two materials (nickel-plated brass and stainless steel) suitable for many applications
 - Numerous valve and safety accessory configurations



Pneumatics
Water Circuits
Machine Tools
Rubber Industry
Packaging
Textile

Applications

Technical Characteristics

	Brass	Stainless Steel			
Compatible Fluids	Compressed air, water, industrial fluids, etc. Other fluids: contact us	Many fluids			
Working Pressure	0 to 120 bar	0 to 400 bar			
Working Temperature	-20°C to +100°C (except model 0510)	-20°C to +180°C			
Tightening Torques	Threads	G1/8	G1/4	G3/8	G1/2
	daN.m	0.10 to 0.20	0.10 to 0.20	0.15 to 0.25	0.20 to 0.35

Reliable performance is dependent upon the type of fluid conveyed.

Component Materials

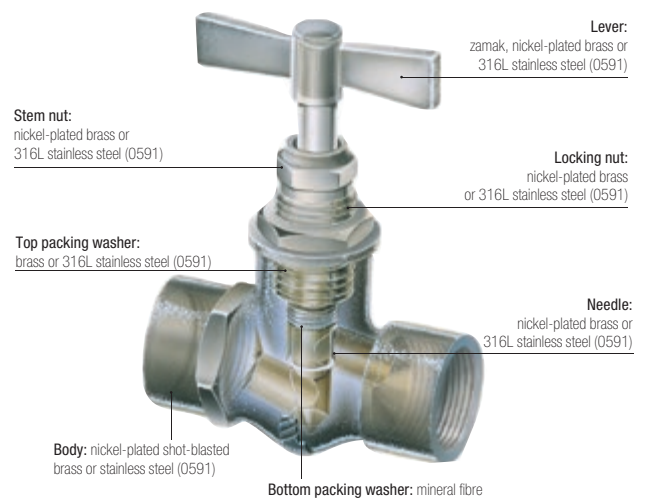

Silicone-free

Regulations

- DI: 97/23/EC (module PED A - diameters greater than 25 mm)
- DI: 2006/42/EC (Machinery Directive)
- DI: 2002/95/EC (RoHS)
- RG: 1907/2006 (REACH)

Brass Needle Valves

0502 In-Line Needle Valve, Female BSPP Thread

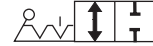

Nickel-plated brass

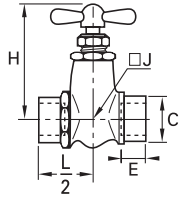

DN	C		E	H	H _{max}	J	L/2	Kg
4	G1/8	0502 04 10	9	56	50	17	23	0.133
	G1/4	0502 04 13	11	56	50	17	23	0.118
6	G3/8	0502 06 17	12	67	60	-	26	0.171
9	G3/8	0502 09 17	12	82	70	-	33	0.426

0501 In-Line Needle Valve, Male/Female BSPP Thread



Nickel-plated brass

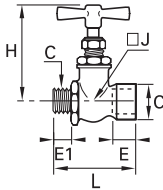

DN	C		E	E1	H	H _{max}	J	L	Kg
4	G1/8	0501 04 10	9	7	56	50	17	44	0.118
	G1/4	0501 04 13	11	9.5	56	50	17	46	0.115
6	G3/8	0501 06 17	12	9.5	67	60	-	48	0.158

0510 In-Line Needle Valve with Compression Connections

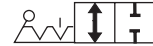

Nickel-plated brass

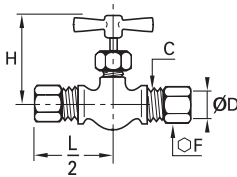

DN	ØD	C		F	H _{min}	H _{max}	L/2	Kg
4	6	M10x1	0510 04 06	13	42	46	29	0.083
8	8	M12x1	0510 05 08	14	42	46	30	0.083
5	10	M16x1.5	0510 05 10	19	42	46	31	0.111

The needle is sealed by an O-ring.
 Maximum operating pressure: Ø4: 100 bar, Ø5: 60 bar
 Working temperature: -15°C to +70°C
 Tightening torques: please refer to the Compression Fittings chapter of this catalogue.

0532 Right-Angle Needle Valve, Female BSPP Thread

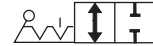

Nickel-plated brass

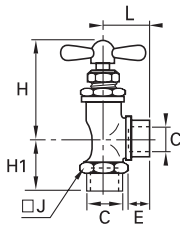

DN	C		E	H _{min}	H _{max}	H1	J	L	Kg
4	G1/8	0532 04 10	9	46	52	19	17	19	0.093
	G1/4	0532 04 13	11	46	52	21	17	21	0.087
6	G1/4	0532 06 13	11	55	63	26	22	26	0.171

0531 Right-Angle Needle Valve, Male/Female BSPP Thread



Nickel-plated brass

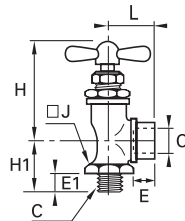

DN	C		E	E1	H _{min}	H _{max}	H1	J	L	Kg
4	G1/8	0531 04 10	7	9	46	52	19	17	19	0.082
	G1/4	0531 04 13	9.5	11	46	52	21	17	21	0.090
6	G1/4	0531 06 13	9.5	11	55	63	25	22	26	0.155
	G3/8	0531 06 17	9.5	12	55	63	25	22	27	0.153
10	G1/2	0531 10 21	13	16	62	72	34	26	33	0.329

Brass Needle Valves

0562 Needle Drain Valve, Male BSPP and Metric Thread

Brass

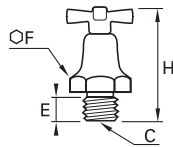

DN	C		E	F	H min	H max	Kg
5	M10x1	0562 05 60	8	16	37.5	40	0.031
	G1/8	0562 05 10	8	16	36	40	0.032
	G1/4	0562 05 13	10	19	38.5	42.5	0.040

0563 Needle Drain Valve, Male NPT Thread

Brass

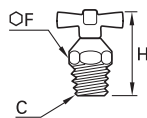

DN	C		F	H min	H max	Kg
5	G1/4	0563 05 14	14	28.5	32.5	0.021

0627 Automatic Vent Pressure Gauge Valve, Female BSPP Thread

Nickel-plated brass, NBR

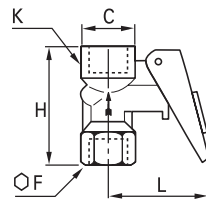

C		F	H	K	L	Kg
G1/4	0627 00 13	19	43.5	20	40	0.097

Pressure: 10 bar

This isolating valve is used to connect a pressure gauge to a circuit.

Resetting the lever isolates and vents the gauge.

A locking pin can be used to enable the gauge to be fitted permanently.

0630 Pressure Relief Valve, Male BSPP Thread

Brass

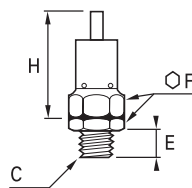

C		E	F	H	Kg
G1/4	0630 06 13	9	17	42,5	0.050

This valve is delivered without calibration, but can be adjusted by inserting metal washers into the hexagon (F).

Maximum working pressure: 10 bar

Calibration from 1 to 10 bar (not below)

Stainless Steel Needle Valves

0591

Needle Valve, Female BSPP Thread



Stainless steel 316L, PTFE

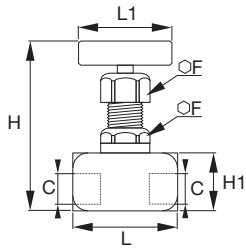

DN	C		F	H min	H max	H1	L	L1	Kg
3	G1/8	0591 03 10	22	90	99	25	45	48	0.345
4	G1/4	0591 04 13	22	90	99	25	50	48	0.355
5	G3/8	0591 05 17	22	90	104	30	56	48	0.430
6	G1/2	0591 06 21	22	90	104	30	62	48	0.483

Butterfly Valves

In these robust valves, the internal component used to shut off the flow is a segment of a sphere. This allows **frequent operation with very low torque, no fluid retention areas** and therefore excellent mechanical performance.

Product Advantages

Compact & Abrasion-Resistant

- Excellent with abrasive fluids (including solid particles)
- Fluid flow direction marked for greater safety (uni-directional)
- Smooth operation
- Can be easily adapted for use with auxiliary actuators
- More compact than a ball valve with equivalent nominal diameter
- Simple and efficient design for a long service life

- ### Applications
- Painting & Printing
 - Machine Tools
 - Pneumatics
 - Powder Conveyance
 - Plumbing
 - Rubber Industry
 - Petrochemical

Technical Characteristics

Compatible Fluids	Compressed air, industrial gases, water, cutting oils, hydraulic oils, fuel oil, fuel, etc.
Working Pressure	0 to 16 bar
Working Temperature	-20°C to +80°C

Reliable performance is dependent upon the type of fluid conveyed.

Component Materials

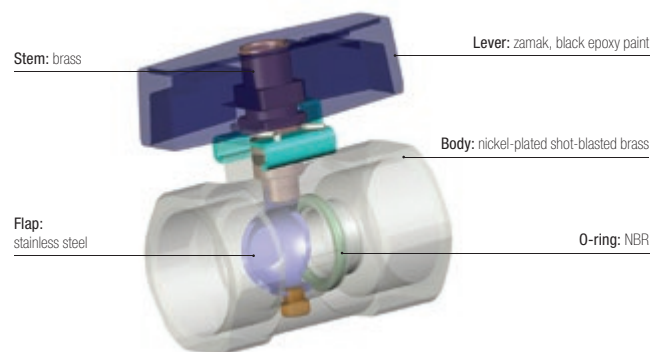

Silicone-free

Regulations

- DI: 97/23/EC (module PED A - diameters greater than 25 mm)
- DI: 2006/42/EC (Machinery Directive)
- DI: 2002/95/EC (RoHS)
- RG: 1907/2006 (REACH)

Butterfly Valves

4602 2/2 Butterfly Shut-Off Valve, Female BSPP Thread



Nickel-plated brass, NBR

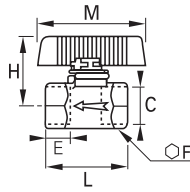

DN	C		E	F	H	L	M	Kg
6	G1/4	4602 06 13	9	17	35	34	54	0.102
7	G3/8	4602 07 17	11	22	35	39	54	0.136
10	G1/2	4602 10 21	12	24	37	42	54	0.140
13	G3/4	4602 13 27	14	30	40	49	54	0.208
18	G1	4602 18 34	15	41	46	55	54	0.412

Black epoxy-coated zamak handle

Axial Valve Range

In-Line Normally Closed

4202..20

FKM Seal
2/2
Page 6-48



4202..30

EPDM Seal
2/2
Page 6-48



In-Line Normally Open

4212..20

FKM Seal
2/2
Page 6-48



4212..30

EPDM Seal
2/2
Page 6-48



In-Line Double-Acting

4222..20

FKM Seal
2/2
Page 6-48



4222..30

EPDM Seal
2/2
Page 6-49



Accessories

4298

Sub-Base
Page 6-49



4298

Solenoid Valve
Page 6-49



4299

Pneumatic Button
Page 6-49



Axial Valves

The Parker Legris axial valve is the only valve to incorporate both the **valve and actuation function**. With pneumatic or electro-pneumatic control, it avoids many of the restrictions associated with traditional actuators.

Product Advantages

Optimisation & Safety

- Very compact: up to 50% smaller than valves with separate actuators
- Simple to install: ready-to-use
- Common sub-base for solenoid control
- Automation of the open/close function
- Operation independent of the upstream and downstream pressure in the circuit

Comprehensive Offer

- Two seal materials for a wider chemical and temperature range
- Pneumatic, electro-pneumatic or dual actuation control
- Three versions: normally closed, normally open and double-acting

Performance

- Full flow: low pressure drop
- Excellent pressure/temperature performance
- Compatible with many industrial fluids



- Applications**
- Flow Control
 - Plastic Injection Moulding
 - Rubber Industry
 - Pneumatics
 - Textile
 - Printing
 - Packaging
 - Robotics

Technical Characteristics

Compatible Fluids	Depending on type of seal – FKM: water, air, oils, greases, etc. – EPDM: hot water, air, steam, etc.
Working Pressure	10 bar max.
Pilot Pressure	NC and NO: 4.2 to 8 bar Double-acting: 3 to 8 bar
Working Temperature	-20°C to +135°C (suffix 20 FKM) -20°C to +120°C (suffix 30 EPDM)

Tightening Torques	Threads	G3/8	G1/2	G3/4	G1	G1¼	G1½	G2
	daN.m	0.15 to 0.25	0.20 to 0.35	0.50 to 0.70	0.50 to 0.70	0.40 to 0.60	0.80 to 1.20	0.80 to 1.20

Reliable performance is dependent upon the type of fluid conveyed, component materials and tubing being used.
Guaranteed for use with a vacuum of 740 mm Hg (97% vacuum).

Flow Curve and Pressure Drop (Kv)

Kv in m³/h (ambient water temperature, under a differential pressure of 1 bar)

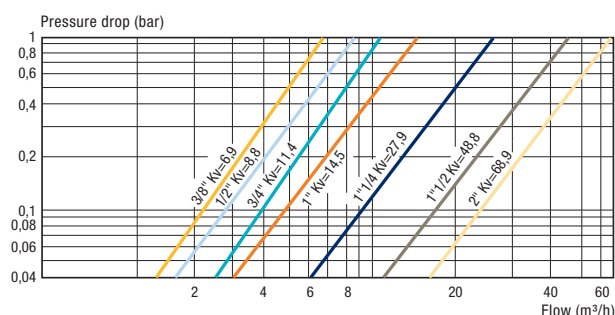

Component Materials

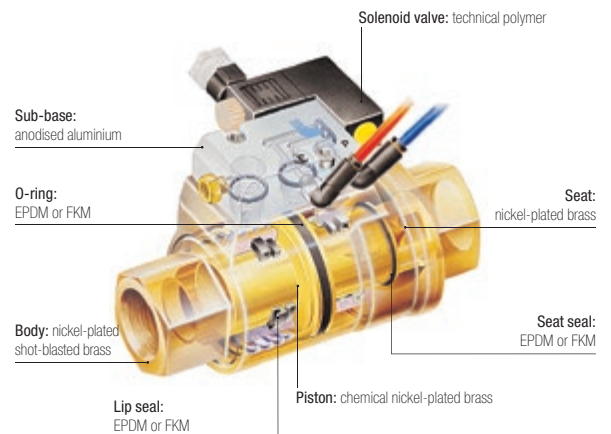

Silicone-free

Regulations

- DI: 97/23/EC (module PED A - diameters greater than 25 mm)
- DI: 2006/42/EC (Machinery Directive)
- DI: 2002/95/EC (RoHS)
- RG: 1907/2006 (REACH)
- DI: 94/9/EC (ATEX) - for pneumatic operation versions

Axial Valves

Operation

Depending on operational requirement, air is passed into the actuation chamber to open or close the valve.

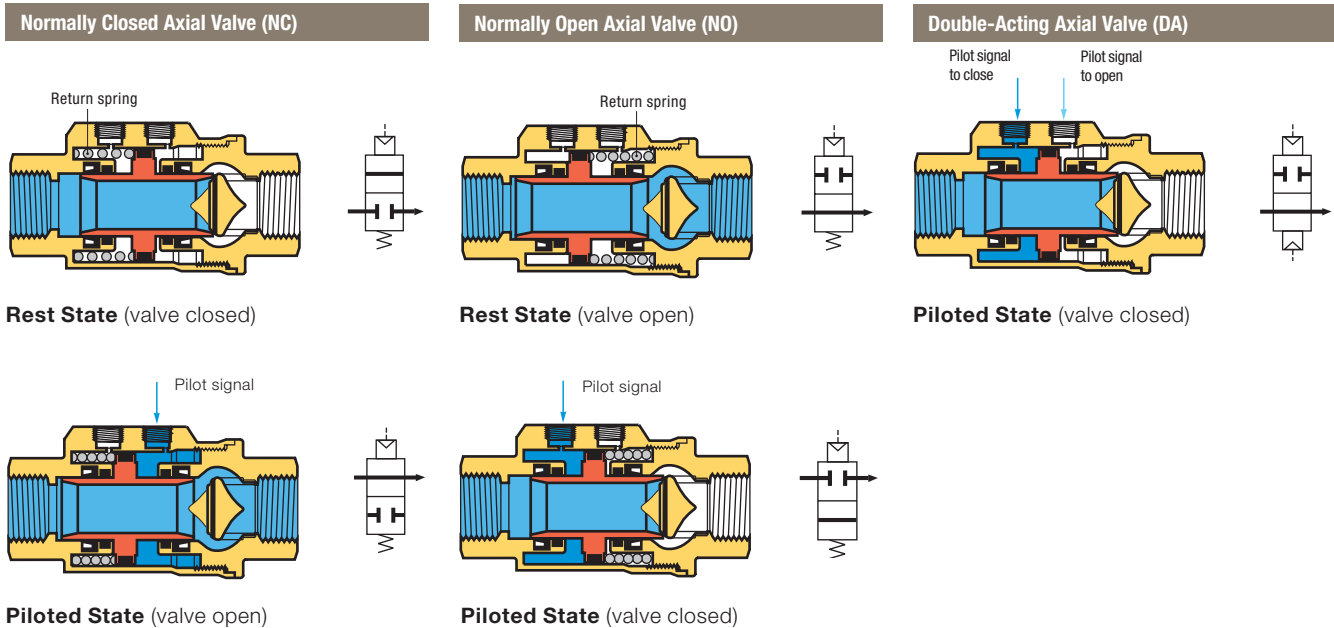

Installation Options

The Parker Legris axial valve offers 3 different control methods dependant on the requirements of the installation:

Pneumatic Control

Example: Double-acting axial valve 4222

- local compressed air control
- for repetitive on/off cycles
- remote control where access to the machine is difficult
- for explosive or explosion prevention areas

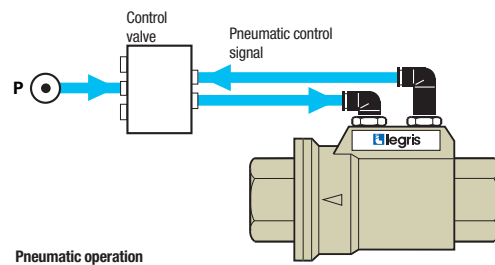

Electro-Pneumatic Control

Example: Normally closed axial valve 4202 + sub-base and Mini-solenoid valve 4298

- for automated industrial systems requiring remote control
- Namur seating plane solenoid valve

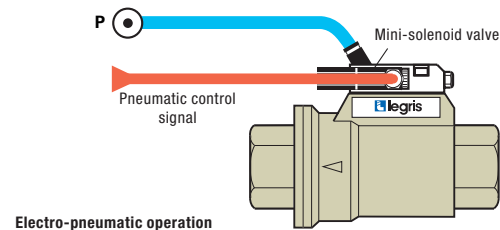

Dual Pneumatic and Electro-Pneumatic Control

Example: Normally open axial valve 4212 + sub-base and Mini-solenoid valve 4298 + Pneumatic push-button 4299

- dual control structure
- for increased safety: prevents localised operating errors
- Namur seating plane solenoid valve

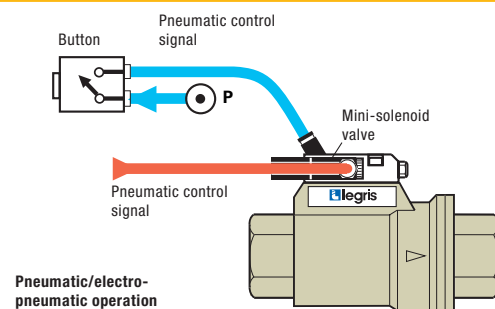

Axial Valves

4202..20 Normally Closed Axial Valve with FKM Seal, Female BSPP Thread

Nickel-plated brass, FKM

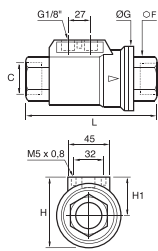

C		F	G	H	H1	L	Kg
G3/8	4202 10 17 20	22	46	54	31	98	0.815
G1/2	4202 15 21 20	27	52	60	35	112	1.093
G3/4	4202 20 27 20	33	64	70	38	135	1.624
G1	4202 25 34 20	41	69	76	41.5	143	2.033
G1 1/4	4202 32 42 20*	50	86	91	48	165	3.266
G1 1/2	4202 40 49 20*	60	96	102	54	180	4.195
G2	4202 50 48 20*	75	109	115	60.5	207	6.465

Pilot port: G1/8

Complete with M5 silencer

*Models with EC marking

4202..30 Normally Closed Axial Valve with EPDM seal, Female BSPP Thread

Nickel-plated brass, EPDM

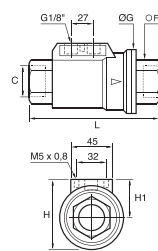

C		F	G	H	H1	L	Kg
G3/8	4202 10 17 30	22	46	54	31	98	0.828
G1/2	4202 15 21 30	27	52	60	35	112	1.097
G3/4	4202 20 27 30	33	64	70	38	135	1.606
G1	4202 25 34 30	41	69	76	41.5	143	2.013
G1 1/4	4202 32 42 30*	50	86	91	48	165	3.315
G1 1/2	4202 40 49 30*	60	96	102	54	180	4.195
G2	4202 50 48 30*	75	109	115	60.5	207	6.360

Pilot port: G1/8

Delivered with a silencer

*Models with EC marking

4212..20 Normally Open Axial Valve with FKM Seal, Female BSPP Thread

Nickel-plated brass, FKM

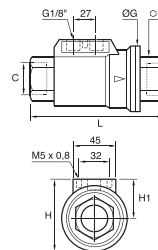

C		F	G	H	H1	L	Kg
G3/8	4212 10 17 20	22	46	54	31	98	0.828
G1/2	4212 15 21 20	27	52	60	35	112	1.096
G3/4	4212 20 27 20	33	64	70	38	135	1.637
G1	4212 25 34 20	41	69	76	41.5	143	2.025
G1 1/4	4212 32 42 20*	50	86	91	48	165	3.301
G1 1/2	4212 40 49 20*	60	96	102	54	180	4.188
G2	4212 50 48 20*	75	109	115	60.5	207	6.555

Pilot port: G1/8

Complete with M5 silencer

*Models with EC marking

4212..30 Normally Open Axial Valve with EPDM seal, Female BSPP Thread

Nickel-plated brass, EPDM

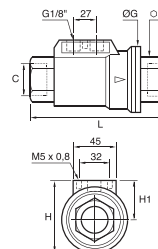

C		F	G	H	H1	L	Kg
G3/8	4212 10 17 30	22	46	54	31	98	0.827
G1/2	4212 15 21 30	27	52	60	35	112	1.152
G3/4	4212 20 27 30	33	64	70	38	135	1.595
G1	4212 25 34 30	41	69	76	41.5	143	1.993
G1 1/4	4212 32 42 30*	50	86	91	48	165	3.301
G1 1/2	4212 40 49 30	60	96	102	54	180	4.775
G2	4212 50 48 30*	75	109	115	60.5	207	6.360

Pilot port: G1/8

Delivered with a silencer

*Models with EC marking

Axial Valves

4222..20 Double-Acting Axial Valve with FKM Seal, Female BSPP Thread

Nickel-plated brass, FKM

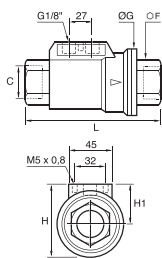

C		F	G	H	H1	L	Kg
G3/8	4222 10 17 20	22	46	54	31	98	0.802
G1/2	4222 15 21 20	27	52	60	35	112	1.050
G3/4	4222 20 27 20	33	64	70	38	135	1.571
G1	4222 25 34 20	41	69	76	41.5	143	1.942
G1 1/4	4222 32 42 20*	50	86	91	48	165	3.058
G1 1/2	4222 40 49 20*	60	96	102	54	180	3.995
G2	4222 50 48 20*	75	109	115	60.5	207	6.275

Pilot port: G1/8

*Models with EC marking

4222..30 Double-Acting Axial Valve with EPDM seal, Female BSPP Thread

Nickel-plated brass, EPDM

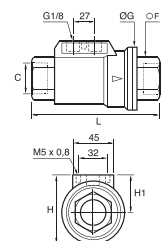

C		F	G	H	H1	L	Kg
G3/8	4222 10 17 30	22	46	54	31	98	0.832
G1/2	4222 15 21 30	27	52	60	35	112	1.046
G3/4	4222 20 27 30	33	64	70	38	135	1.662
G1	4222 25 34 30	41	69	76	41.5	143	1.943
G1 1/4	4222 32 42 30*	50	86	91	48	165	3.301
G1 1/2	4222 40 49 30*	60	96	102	54	180	4.260
G2	4222 50 48 30*	75	109	115	60.5	207	6.520

Pilot port: G1/8

Delivered with a silencer

*Models with EC marking

4298 Sub-Base for Solenoid Pilot Valve

Treated aluminium, NBR

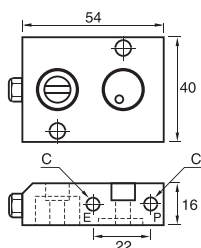

C		Kg
M5x0.8	4298 00 01	0.095

The sub-base is fitted directly to the axial valve and allows the mounting of a 15x15 solenoid valve. Supplied with 2 fixing bolts, silencer and seats.

4298 Mini-Solenoid Valve 1W/12VA

Anodised aluminium

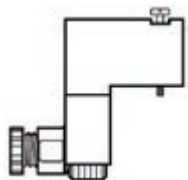

Voltage		Kg
24V = CC*	4298 01 01	0.051
24V ~ CA**	4298 01 02	0.058
110V ~ CA**	4298 02 01	0.051
220V ~ CA**	4298 02 02	0.054

*Direct current

**Alternating current

4299 Pneumatic Button/Electro-Pneumatic

Nickel-plated brass, technical polymer

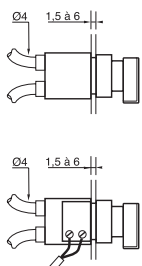

Contact		Kg
Standard*	4299 01 01	0.090
With key*	4299 01 02	0.110
Standard**	4299 02 01	0.102
With key**	4299 02 02	0.124

Bulkhead fixing hole diameter: Ø22 mm

*1 pneumatic contact

**1 electro-pneumatic contact

Available upon request

Industrial Blowguns

Polymer

Metal

Kits



Blowguns

Standard Blowgun (P. 7-7)



Fluids: compressed air
Materials: technical polymer, NBR
Pressure: 10 bar
Temperature: -15°C to +50°C
DN: : 3.5 mm

Safety Blowgun (P. 7-7)



Fluids: compressed air
Materials: technical polymer, NBR
Pressure: 10 bar
Temperature: -15°C to +50°C
DN: : 3 mm

Energy-Saving Blowgun (P. 7-8)



Fluids: compressed air
Materials: technical polymer, NBR
Pressure: 10 bar
Temperature: -15°C to +50°C
DN: : according to nozzle

Versatile Blowguns (P. 7-6)



Fluids: compressed air
Materials: technical polymer, NBR
Pressure: 10 bar
Temperature: -15°C to +50°C
DN: : according to nozzle

Metal Blowguns (P. 7-14)



Fluids: compressed air
Materials: forged nickel-plated brass, NBR
Pressure: 10 bar
Temperature: -15°C to +50°C
DN: : 2 mm

Water Pistol (P. 7-14)



Fluids: industrial fluids and water
Materials: zamak, NBR
Pressure: 20 bar
Temperature: -20°C to +100°C
DN: : 12 mm

Blowgun Kits (P. 7-16)



Fluids: compressed air
Materials: technical polymer
Pressure: 10 bar
Temperature: -15°C to +50°C
DN: : according to model

Nozzles (P. 7-11)



Fluids: compressed air
Materials: nickel-plated brass
Pressure: 10 bar
Temperature: -15°C to +50°C
DN: : according to model

Blowgun Range

Polymer Blowguns

Standard

0659
Page 7-7



Safety

0654
Page 7-7



SUVA Safety

0654
Page 7-7



Energy-Saving

0653
Lower Connection
Interchangeable Nozzle
Page 7-8



0653
Lower Connection
Page 7-8



With Interchangeable Nozzle

0652
Lower Connection
Page 7-8



0655
Upper Connection
Page 7-8



Pre-Assembled with Nozzle

0651
Lower Connection
Page 7-9



0658
Upper Connection
Page 7-9



0656
Lower Connection
Page 7-9



0657
Upper Connection
Page 7-9



Merchandising Box

065.. 13 02
Page 7-10



Nozzles for Polymer Blowguns

0690 01
Standard
Page 7-11



0690 02
Safety
Page 7-11



0690 03
Straight Tube (long)
Page 7-11



0690 04
Straight Tube (short), Safety
Page 7-11



0690 05
Angled Tube (long)
Page 7-11



0690 06
Angled Tube (short) Safety
Page 7-12



0690 06 01
Angled Tube (short)
Page 7-12



0690 07
LF 3000® Nozzle
Page 7-12



0690 08
Coanda
Page 7-12



0690 09
Air Screen
Page 7-12



0690 10
Booster
Page 7-13



0690 11
Booster with Air Screen
Page 7-13



Metal Blowguns

Lever-Operated

0623
Page 7-15



Button-Operated

0622
Page 7-15



Water Pistol

2299
Page 7-15



2299
Page 7-15



Blowgun Kits

0631..09
Standard
Page 7-17



0631..01
Safety
Page 7-17



0631..30
Safety, SUVA-Certified
Page 7-17



0631..23
Energy-Saving
Page 7-17



0631..03
0631..02
Standard Nozzle
Page 7-18



0631..05
0631..04
Angled Nozzle, Safety
Page 7-18



0631..07
0631..06
Interchangeable Nozzle
Page 7-18



0631..08
Energy-Saving
Interchangeable Nozzle
Page 7-18



Polymer Blowguns

The Parker Legris polymer blowgun offers **ease of use**, **energy saving**, adaptability and efficiency. These blowguns comply with **international regulations** for health, **safety** and **noise** levels.

Product Advantages

Quality & Performance

Comply with international standards for noise and pressure regulation
 Powerful flow with progressive control
 Rotating nozzle for directional jet
 Durable, shock-resistant materials
 100% leak and flow-tested in production
 Date coding to guarantee quality and traceability

Safety & Sustainable Development

40% energy consumption reduction with Energy-Saving model
 Complete user safety with the Safety model
 Wide selection of nozzles which comply with noise and pressure level regulations

Ergonomics & Versatility

Comfortable to use
 Lightweight and easy to use
 Wide range of models and nozzles for optimum blowing power and flow rate
 Lower or upper connection



Manufacturing Workshops

Cleaning
 Blowing
 Mixing
 Ejection
 Cooling
 Packaging

Applications

Technical Characteristics

Compatible Fluids	Compressed air Other fluids: contact us
Working Pressure	0 to 10 bar
Working Temperature	Air: -15°C to +50°C Dry air: -20°C to +80°C
Tubes	Recoil tubes and hose

Regulations

Compliance for all blowguns:

DI: 97/23/EC (PED)
 DI: 2002/95/EC (RoHS),
 2011/65/EC
 DI: 1907/2006 (REACH)

Protection of design

All designs and models of Parker Legris blowguns have been registered with the following numbers: 13224 / 13225 / 13226.

Compliance for specific blowguns:

DI: 1910.242 (b) [OSHA]
 The static pressure must be less than 30 psi in case the nozzle becomes blocked.
 DI: 1910.95 (b) [OSHA]
 The noise level must be less than 90 dBA over 8 hours' exposure.
 DI: 2003/10/EC
 Regulation relating to exposure to noise, particularly with regard to risks to hearing. The noise level must be less than 87 dBA.

Component Materials



Silicone-free

Polymer Blowguns

0659 Standard Blowgun, Lower Connection with Short Angled Nozzle, Female BSPP Thread

Technical polymer, nickel-plated brass, treated aluminium, NBR

C	DN		F	H	L	Kg
G1/4	3.5	0659 00 13	20	120	223	0.072

Nozzle: aluminium, NPT version available

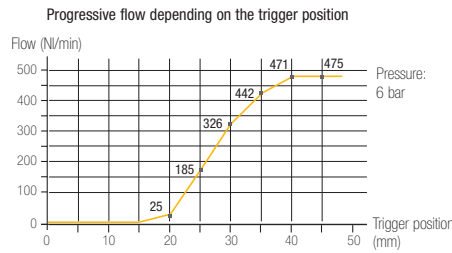
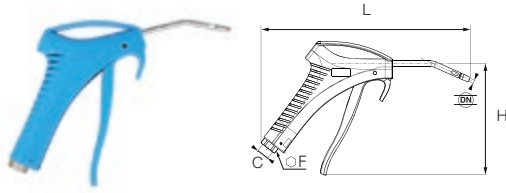

- 475 Nl/min
- 82 dBA
- OSHA 1910.242 (b)
- OSHA 1910.95 (b)
- 2003/10/EC directive:
- Requirement to use ear protection if exposure > 8 hours

0654 Safety Blowgun, Lower Connection, Female BSPP Thread

Technical polymer, nickel-plated brass, NBR

C	DN		F	H	H1	L	L1	Kg
G1/4	3	0654 00 13	20	117	35	148	73	0.189

Nozzle: nickel-plated brass, NPT version available.

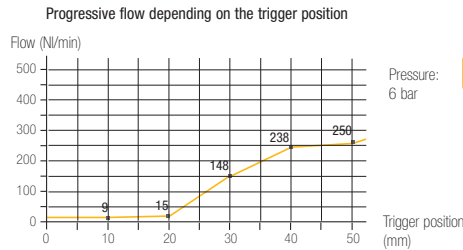
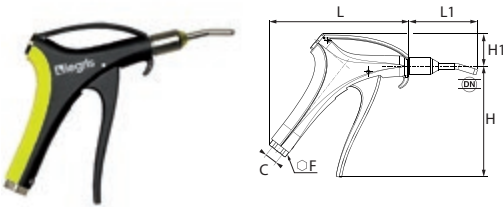

- 250 Nl/min
- 80 dBA
- OSHA 1910.242 (b)
- OSHA 1910.95 (b)
- 2003/10/EC directive:
- No ear defenders necessary

0654 SUVA Safety Blowgun, Lower Connection, Female BSPP Thread

Technical polymer, nickel-plated brass, NBR

C	DN		F	H	H1	L	L1	Kg
G1/4	3	0654 00 13	20	117	35	148	73	0,189

Nozzle: nickel-plated brass, NPT version available.

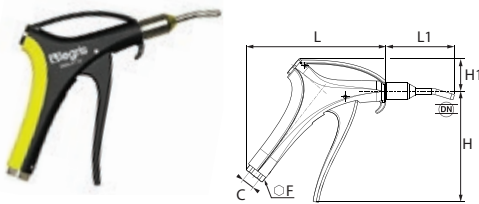

suva
CERTIFICATION

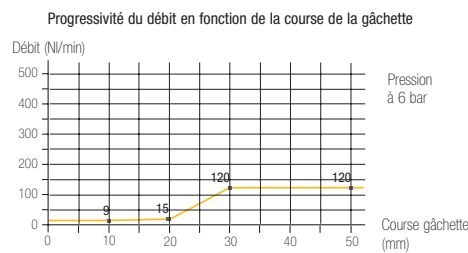

- 120 Nl/min
- 80 dBA
- OSHA 1910.242 (b)
- OSHA 1910.95 (b)
- Directive 2003/10/CE :
- Aucun écouteur auditif nécessaire
- SUVA: 7030d et 7030e

Maximum Flow Rate
(tolerance +/-10%)

Noise Level
ISO 15744

Diffusion
Cone

Compliance
with Standards

Operation: Safety Blowgun



Flow stopped completely and pressure reduced to 0.5 bar

Operation: Blowgun with Safety Nozzle



Flow diverted and pressure reduced to 0.5 bar

ECO
DESIGN

Polymer Blowguns



0653 Energy Saving Blowgun, Lower Connection with Interchangeable Nozzle, Female BSPP Thread

Technical polymer, nickel-plated brass, NBR

C	C1		F	H	H1	L	Kg
G1/4	M12x1.25	0652 66 13	20	117	34	147	0.163

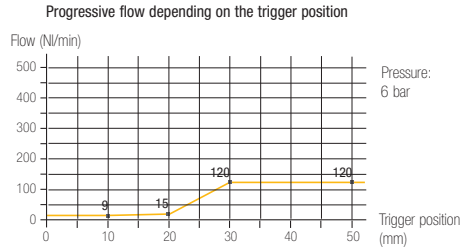
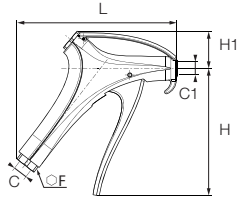
Flow characteristics depend on the type of nozzle used.
Delivered without nozzle.



 120 Nl/min Flow produced with nozzle 0690 01 00
 80 dBA Noise level measured without nozzle
 OSHA 1910.242 (b): Depends on type of nozzle
 OSHA 1910.95 (b)
 2003/10/EC directive:
 No ear defenders necessary



0653 Energy Saving Blowgun, Lower Connection with Short Angled Nozzle, Female BSPP Thread

Technical polymer, nickel-plated brass, NBR

C	C1		F	H	H1	L	L1	Kg
G1/4	M12x1.25	0653 02 13	20	117	34	147	78	0.144

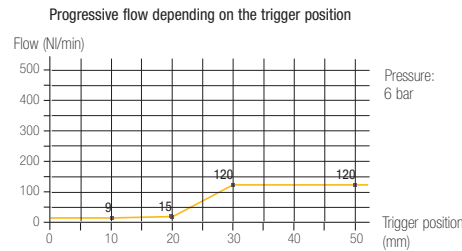
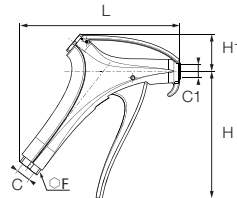
Flow characteristics depend on the type of nozzle used, delivered without nozzle.
An energy saving calculator is available.



 120 Nl/min Flow produced with nozzle 0690 01 00
 80 dBA Noise level measured without nozzle
 OSHA 1910.242 (b): Depends on type of nozzle
 OSHA 1910.95 (b)
 2003/10/EC directive:
 No ear defenders necessary



0652 Progressive Control Blowgun, Lower Connection with Interchangeable Nozzle, Female BSPP Thread

Technical polymer, nickel-plated brass, NBR

C	C1		F	H	H1	L	Kg
G1/4	M12x1.25	0652 66 13	20	117	34	147	0.163

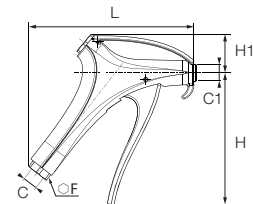
Flow characteristics depend on the type of nozzle used.
Delivered without nozzle.



 Depending on the type of nozzle
 86 dBA Noise level measured without nozzle
 OSHA 1910.242 (b): Depends on type of nozzle
 OSHA 1910.95 (b)
 2003/10/EC directive:
 Requirement to use ear protection if exposure > 8 hours



0655 Progressive Control Blowgun, Upper Connection with Interchangeable Nozzle, Female BSPP Thread

Technical polymer, nickel-plated brass, NBR

C		F	H	H1	L	Kg
G1/4	0655 66 13	20	117	37	145	0.163

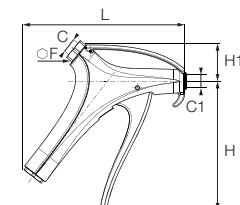
Flow characteristics depend on the type of nozzle used.
Delivered without nozzle.



 Depending on the type of nozzle
 86 dBA Noise level measured without nozzle
 OSHA 1910.242 (b): Depends on type of nozzle
 OSHA 1910.95 (b)
 2003/10/EC directive:
 Requires ear defenders to be used when exposure is > 8 hours

Polymer Blowguns

0651 Progressive Control Blowgun, Lower Connection with Standard Nozzle, Female BSPP Thread

Technical polymer, nickel-plated brass, NBR

C	DN		F	H	H1	L	L1	Kg
G1/4	2.5	0651 66 13	20	117	34	147	10	0.168

Nozzle: nickel-plated brass

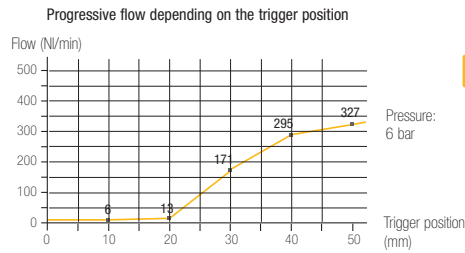
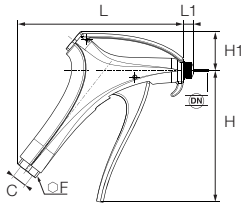

- 327 Nl/min Flow produced with nozzle **0690 01 00**
- 86 dBA
- OSHA 1910.95 (b)
2003/10/EC directive:
Requirement to use ear protection if exposure > 8 hours

0658 Progressive Control Blowgun, Upper Connection with Standard Nozzle, Female BSPP Thread

Technical polymer, nickel-plated brass, NBR

C	DN		F	H	H1	L	L1	Kg
G1/4	2.5	0658 66 13	20	117	37	145	10	0.195

Nozzle: nickel-plated brass

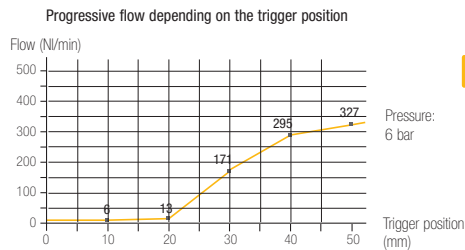
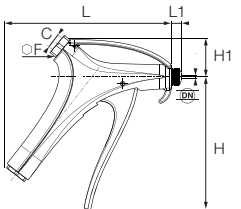

- 327 Nl/min Flow produced with nozzle **0690 01 00**
- 86 dBA
- OSHA 1910.95 (b)
2003/10/EC directive:
Requirement to use ear protection if exposure > 8 hours

0656 Progressive Control Blowgun, Lower Connection with Short Angled Nozzle, Female BSPP Thread

Technical polymer, nickel-plated brass, NBR

C	DN		F	H	H1	L	L1	Kg
G1/4	2.5	0656 66 13	20	117	34	147	81	0.173

Nozzle: nickel-plated brass

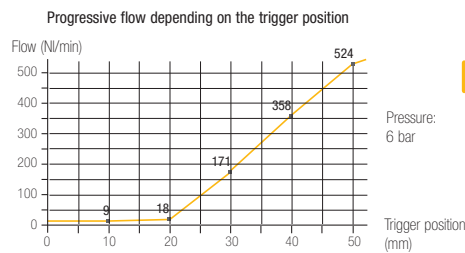
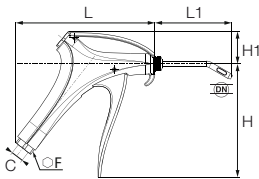

- 524 Nl/min Flow produced with nozzle **0690 06 01**
- 86 dBA
- OSHA 1910.242 (b)
OSHA 1910.95 (b)
2003/10/EC directive:
Requirement to use ear protection if exposure > 8 hours

0657 Safety Progressive Control Blowgun, Upper Connection with Short Angled Nozzle, Female BSPP Thread

Technical polymer, nickel-plated brass, NBR

C	DN		F	H	H1	L	L1	Kg
G1/4	2.5	0657 66 13	20	117	37	145	82	0.168

Nozzle: nickel-plated brass

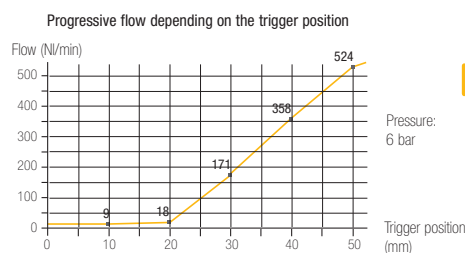
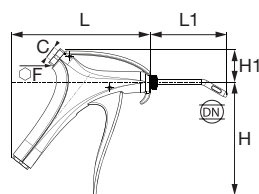

- 524 Nl/min Flow produced with nozzle **0690 06 01**
- 86 dBA
- OSHA 1910.242 (b)
OSHA 1910.95 (b)
2003/10/EC directive:
Requirement to use ear protection if exposure > 8 hours

Merchandising Box of Polymer Blowguns

0659 Merchandising Box - 10 Standard Blowguns



0659 00 13 02

The box includes 10 blowguns 0659 00 13.

L	H	L1	Kg
28	16	20	1.720

0654 Merchandising Box - 10 Safety Blowguns



0654 00 13 02

The box includes 10 blowguns 0654 00 13.

L	H	L1	Kg
28	16	20	1.890

0654 Merchandising Box - 10 SUVA Safety Blowguns



0654 01 13 02

The box includes 10 blowguns 0654 01 13.

suvapro
CERTIFICATION

L	H	L1	Kg
28	16	20	2.356

0653 Merchandising Box - 10 Energy-Saving Blowguns



0653 02 13 02

The box includes 10 blowguns 0653 02 13.

L	H	L1	Kg
28	16	20	1.900

0656 Merchandising Box - 10 Progressive Control Blowguns



0656 66 13 02

The box includes 10 blowguns 0656 66 13.

L	H	L1	Kg
28	16	20	1.730

Nozzles for Polymer Blowguns

0690 01 Standard Nozzle

Nickel-plated brass

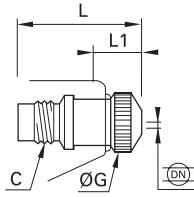

C	DN		G	L	L1	Kg
M12x1.25	2.5	0690 01 00	15	31	9	0.023



327 Nl/min

86 dBA

23°

- Versatile use
- Progressive and powerful air jet

OSHA 1910.95 (b)
2003/10/EC directive:
Requirement to use ear protection
if exposure > 8 hours

0690 02 Safety Nozzle

Nickel-plated brass

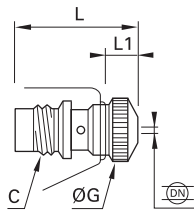

C	DN		G	L	L1	Kg
M12x1.25	2.5	0690 02 00	15	31	9	0.024



315 Nl/min

83 dBA

26°

- Fluidised Powders
- Air screen effect
- Safety: avoids the nozzle becoming completely blocked

OSHA 1910.95 (b)/1910.242 (b)
2003/10/EC directive:
Requirement to use ear protection
if exposure > 8 hours

0690 03 Straight Nozzle (Long)

Nickel-plated brass, NBR

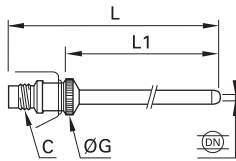

C	DN		G	L	L1	Kg
M12x1.25	2.5	0690 03 00	15	332	307	0.068



386 Nl/min

82 dBA

21°

- Restricted access
- Progressive and powerful air jet

OSHA 1910.95 (b)
2003/10/EC directive:
Requirement to use ear protection
if exposure > 8 hours

0690 04 Safety Straight Nozzle (Short)

Nickel-plated brass, NBR

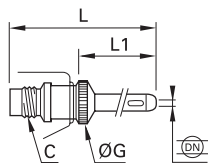

C	DN		G	L	L1	Kg
M12x1.25	2.5	0690 04 00	15	102	77	0.033



410 Nl/min

82 dBA

21°

- Restricted access
- Air screen effect and directional jet
- Safety: avoids the nozzle becoming completely blocked

OSHA 1910.242 (b)/ OSHA 1910.95 (b)
2003/10/EC directive:
Requirement to use ear protection
if exposure > 8 hours

0690 05 Angled Nozzle (Long)

Nickel-plated brass, NBR

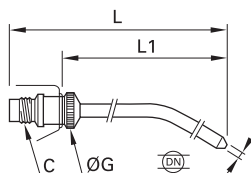

C	DN		G	L	L1	Kg
M12x1.25	2.5	0690 05 00	15	316	292	0.065



354 Nl/min

82 dBA

21°

- Restricted or distant access
- Progressive and powerful air jet
- 360° rotation

OSHA 1910.95 (b)
2003/10/EC directive:
Requirement to use ear protection
if exposure > 8 hours

Nozzles for Polymer Blowguns

0690 06 Safety Angled Nozzle (Short)

Nickel-plated brass, NBR

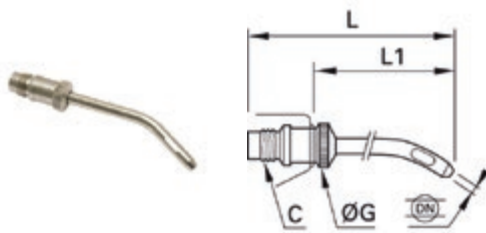

C	DN		G	L	L1	Kg
M12x1.25	2.5	0690 06 00	15	94	70	0.033



- Restricted access
- Air screen effect and 360° directional jet
- Safety: avoids the nozzle becoming completely blocked

350 NI/min

86 dBA

21°

OSHA 1910.242 (b)/ OSHA 1910.95 (b)
2003/10/EC directive:
Requirement to use ear protection if exposure > 8 hours

0690 06 01 Angle Nozzle (Short)

Nickel-plated brass, NBR

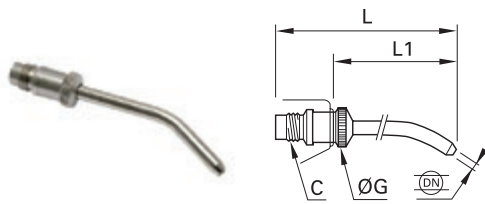

C	DN		G	L	L1	Kg
M12x1.25	2.5	0690 06 01	15	94	70	0.034



- Difficult access
- Progressive and powerful air jet, 360° rotation

524 NI/min

86 dBA

21°

OSHA 1910.95 (b)
2003/10/EC directive:
Requirement to use ear protection if exposure > 8 hours

0690 07 Nozzle with LF 3000® Push-In Connection

Nickel-plated brass, NBR

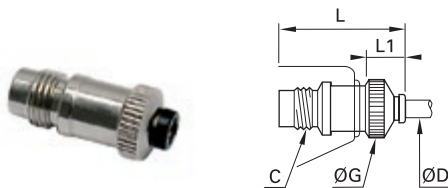

ØD	C		G	L	L1	Kg
4	M12x1.25	0690 07 00	15	35	13	0.024



- Restricted access
- Progressive air jet

340 NI/min (with 2.7x4 tube)
200 NI/min (with 2x4 tube)

86 dBA

21°

OSHA 1910.95 (b)
2003/10/EC directive:
Requirement to use ear protection if exposure > 8 hours

0690 09 Air Screen Safety Nozzle

Nickel-plated brass

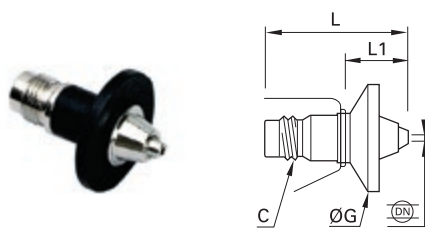

C	DN		G	L	L1	Kg
M12x1.25	2	0690 09 00	30	40.5	18.5	0.022

Deflector: technical polymer



- High flow for blowing large surfaces
- Air screen and deflector to avoid particles being blown back
- Safety: avoids the nozzle becoming completely blocked

660 NI/min

86 dBA

24° nozzle
140° screen

OSHA 1910.242 (b)/ OSHA 1910.95 (b)
2003/10/EC directive:
Requirement to use ear protection if exposure > 8 hours

0690 08 COANDA Nozzle

Nickel-plated brass



C		L	L1	Kg
M12x1.25	0690 08 00	47.5	26	0.033



- Directional air jet
- Very quiet, energy-saving
- Safety: avoids the nozzle becoming completely blocked

240 NI/min

73 dBA

20°

OSHA 1910.242 (b)/ OSHA 1910.95 (b)
2003/10/EC directive:
No ear defenders necessary

Nozzles for Polymer Blowguns

0690 10

Safety Booster Nozzle

Nickel-plated brass

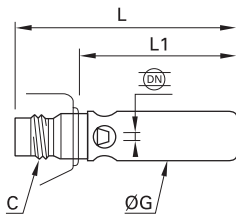

C	DN		G	L	L1	Kg
M12x1.25	2.5	0690 10 00	15	64	42	0.038

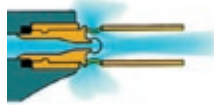

- High flow for blowing large surfaces
- Air screen effect
- Safety: avoids the nozzle becoming completely blocked

780 Nl/min

99 dBA

28°

OSHA 1910.242 (b)
2003/10/EC directive:
Requires ear defenders to be used at all times

0690 11

Safety Booster Nozzle with Air Screen

Nickel-plated brass

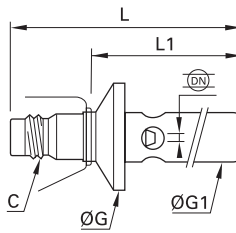

C	DN		G	G1	L	L1	Kg
M12x1.25	2.5	0690 11 00	30	15	76	54	0.046

Deflector: technical polymer

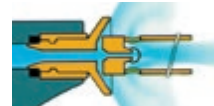

- Same advantage as the Booster nozzle
- Safety: avoids the nozzle becoming completely blocked
- Air screen and deflector avoid particles being blown back

860 Nl/min

99 dBA

26° nozzle
140° screen

OSHA 1910.242 (b)
2003/10/EC directive:
Requires ear defenders to be used at all times

Metal Blowguns and Water Pistols

This range of robust blowguns guarantees a **longer service life** under **severe conditions** (crushing, impact, shock and corrosion). It includes two versions **to meet all requirements** for blowing and spraying in industrial applications.

Product Advantages

Workshop Blowgun

Compact for easy incorporation into compressed air ring mains
Nickel-plated forged brass for increased corrosion resistance

Water Pistol

Intended for the transmission of water and fluids
Designed for precise flow control and optimisation of the power and shape of the jet
Optimum use of industrial fluids
Excellent ergonomics and service life



Manufacturing Workshops
Assembly Machines
Robotics
Ejection
Cooling
Packaging
Automotive Process

Applications

Technical Characteristics

Model	Metal Blowgun	Water Pistol
Compatible Fluids	Compressed air, industrial fluids	Water, oil, industrial fluids
Working Pressure	0 to 10 bar	0 to 20 bar
Working Temperature	Air: -15°C to +50°C Dry air: -20°C to +80°C	-20°C to +100°C
Tubes	Recoil tubes and hose	Braided hose with Parker Legris couplers

Component Materials

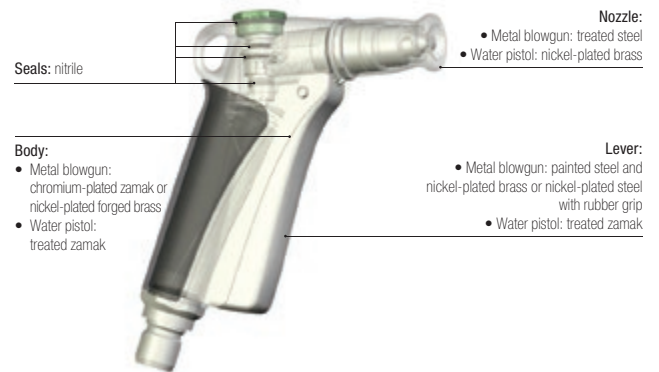

Silicone-free

Regulations

Compliance for all blowguns:

DI: 97/23/EC (PED)

DI: 2002/95/EC (RoHS), 2011/65/EC

DI: 1907/2006 (REACH)

Metal Blowguns and Water Pistols

0623 Lever-Operated Blowgun, Female BSPP Thread

Nickel-plated brass, zinc-plated blister steel, NBR

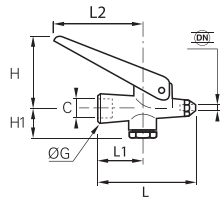

C	DN		G	H min	H max	H1	L	L1	L2	Kg
G1/4	2		18	19	37	21	64	28	60	0.119

This blowgun has a hardened steel nozzle.

0622 Button-Operated Blowgun, Female BSPP Thread

Nickel-plated brass, zinc-plated blister steel, NBR

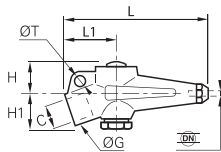

C	DN		G	H	H1	L	L1	ØT	Kg
G1/4	2		18	17.5	20.5	82	29	7	0.199

This blowgun has a hardened steel nozzle.

2299 Water Pistol

Zamak, nickel-plated brass, NBR

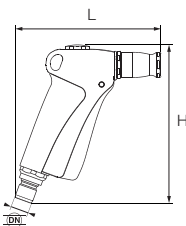

DN		H	L	Kg
12		140	126	0.468

This pistol allows independent control of:

- the flow rate (trigger)
- type of jet (adjustable to a fine mist) by the adjustable nozzle

1440 Nl/min (air)
16.2 Nl/min (eau)

Adjustable

2299 Adjustable Nozzle

Nickel-plated brass, NBR

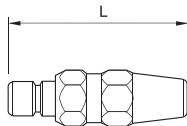

DN		L	Kg
12		77.4	0.137

This nozzle allows adjustment of the spray.

Related Products

For optimum connection and usage of the pistol and adjustable nozzle, you will find a full range of quick-acting couplers, in the Midi and Maxi Series, in Chapter 8.

Midi P. 8-25



Maxi P. 8-29



Blowgun Kits

Ready for use, **simple** and **ergonomic**, the Parker Legris blowgun kit remains an essential item of equipment for any blowing or spraying operation in the industrial environment.

Product Advantages

Ready for Use

- Kit contents:
- one blowgun
 - a 4 metre recoil tube
 - one R1/4 threaded fitting, external diameter 8 mm
- Easy to install and comfortable to use
 Wide range of models and nozzles for optimum flow
 Lower or upper connection
 Labelling and colours can be customised
 Packaging designed to facilitate self-service sales

Safety & Performance

- Safe operation with the Safety or OSHA models
 Durable, shock-resistant materials
 100% leak and flow-tested in production
 Date coding to guarantee quality and traceability
 Minimum pressure drop
 Optimisation of your energy consumption with the Energy-Saving model



Manufacturing Workshops
 Cleaning
 Blowing
 Mixing
 Ejection
 Cooling
 Packaging

Applications

Technical Characteristics

Compatible Fluids	Compressed air Other fluids: contact us
Working Pressure	0 to 10 bar
Working Temperature	Air: -15°C to +50°C Dry air: -20°C to +80°C
Tubes	Recoil tubing

Regulations

Compliance for all blowguns:

DI: 97/23/EC (PED)
 DI: 2002/95/EC (RoHS), 2011/65/EC
 DI: 1907/2006 (REACH)

Protection of design

All designs and models of Parker Legris blowguns have been registered with the following numbers: 13224 / 13225 / 13226.

Compliance for specific blowguns:

DI: 1910.242 (b) [OSHA]
 The static pressure must be less than 30 psi in case the nozzle becomes blocked.
 DI: 1910.95 (b) [OSHA]
 The noise level must be less than 90 dBA over 8 hours' exposure.
 DI: 2003/10/EC
 Regulation relating to exposure to noise, particularly with regard to risks to hearing. The noise level must be less than 87 dBA.

Component Materials

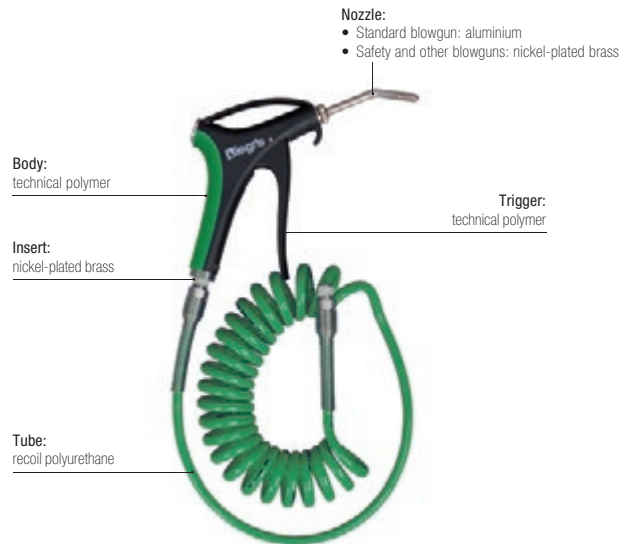

Silicone-free

Customisation on request

- Marking
- Kit contents adaptable to your applications
- Additional functions
- Colour



Blowgun Kits

0631..09 Blowgun Kit, Lower Connection, Female BSPT Thread

Technical polymer, nickel-plated brass, treated aluminium, NBR

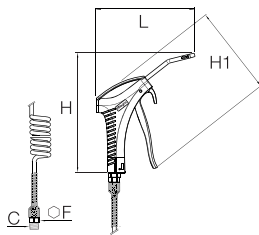

C		F	H	H1	L	Kg
R1/4	0631 00 09	16	192.5	139.5	152	0.441

Flow characteristics, noise level and norm compliance are identical to those of our blowguns (0659 00 13).

0631..01 Safety Blowgun Kit, Lower Connection, Male BSPT Thread

Technical polymer, nickel-plated brass, NBR

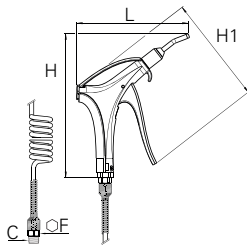

C		F	H	H1	L	Kg
R1/4	0631 00 01	16	198.5	148.5	154	0.575

Flow characteristics, noise level and norm compliance are identical to those of our blowguns (0654 00 13).

0631..30 Safety Blowgun, Lower Connection, Female BSPP Thread

Technical polymer, nickel-plated brass, NBR

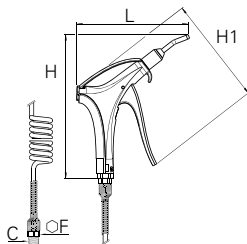

C		F	H	H1	L	Kg
R1/4	0631 00 30	16	198.5	148.5	154	0.575

Nozzle: nickel-plated brass, NPT version available.

Flow characteristics, noise level and norm compliance are identical to those of our blowguns (0654 01 13).

suva
pro
CERTIFICATION

0631..23 Energy Saving Blowgun Kit with Angled Nozzle, Male BSPT Thread

Technical polymer, nickel-plated brass, NBR

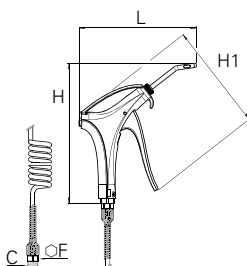

C		F	H	H1	L	Kg
R1/4	0631 00 23	16	195	148.5	163	0.456

Flow characteristics, noise level and norm compliance are identical to those of our blowguns (0653 66 13).

External diameter of tube 6 mm

Blowgun Kits

0631..03 Blowgun Kit, Lower Connection with Standard Nozzle, Male BSPT Thread

Technical polymer, nickel-plated brass, NBR

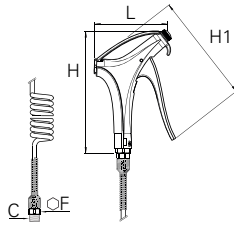

C		F	H	H1	L	Kg
R1/4	0631 00 03	16	165	148.5	99	0.528

Flow characteristics, noise level and norm compliance are identical to those of our blowguns (0651 66 13).

0631..02 Blowgun Kit, Upper Connection with Standard Nozzle, Male BSPT Thread

Technical polymer, nickel-plated brass, NBR

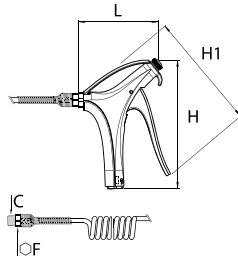

C		F	H	H1	L	Kg
R1/4	0631 00 02	16	163	148.5	101	0.524

Flow characteristics, noise level and norm compliance are identical to those of our blowguns (0658 66 13).

0631..04 Blowgun Kit, Upper Connection with Short Angled Nozzle, Male BSPT Thread

Technical polymer, nickel-plated brass, NBR

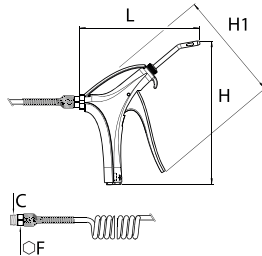

C		F	H	H1	L	Kg
R1/4	0631 00 04	16	195	148.5	163.5	0.536

Flow characteristics, noise level and norm compliance are identical to those of our blowguns (0657 66 13).

0631..05 Blowgun Kit Lower Connection with Short Angled Nozzle, Male BSPT Thread

Technical polymer, nickel-plated brass, NBR

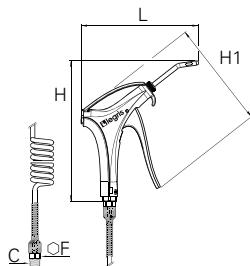

C		F	H	H1	L	Kg
R1/4	0631 00 05	16	195.5	148.5	163	0.536

Flow characteristics, noise level and norm compliance are identical to those of our blowguns (0656 66 13).

Blowgun Kits

0631..07 Blowgun Kit, Lower Connection with Interchangeable Nozzle, Male BSPT Thread

Technical polymer, nickel-plated brass, NBR

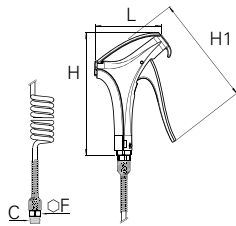

C		F	H	H1	L	Kg
R1/4	0631 00 07	16	163	148.5	91	0.617

Flow characteristics, noise level and norm compliance are identical to those of our blowguns (0656 66 13).
Delivered without nozzle.

0631..06 Blowgun Kit, Upper Connection with Interchangeable Nozzle, Male BSPT Thread

Technical polymer, nickel-plated brass, NBR

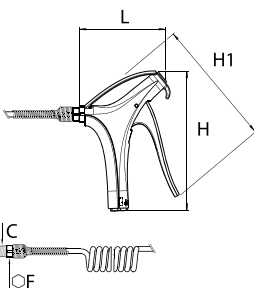

C		F	H	H1	L	Kg
R1/4	0631 00 06	16	161.5	148.5	93	0.501

Flow characteristics, noise level and norm compliance are identical to those of our blowguns (0655 66 13).
Delivered without nozzle.

0631..08 Energy Saving Blowgun Kit, Lower Connection, Interchangeable Nozzle, Male BSPT Thread

Technical polymer, nickel-plated brass, NBR

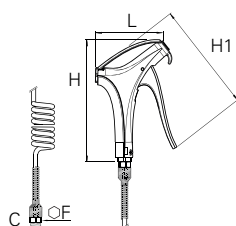

C		F	H	H1	L	Kg
R1/4	0631 00 08	16	163	148.5	91	0.496

Flow characteristics, noise level and norm compliance are identical to those of our blowguns (0653 66 13).
Delivered without nozzle.

Quick-Acting Couplers

Polymer Safety, C 9000

Metal

Quick-Acting Couplers Accessories

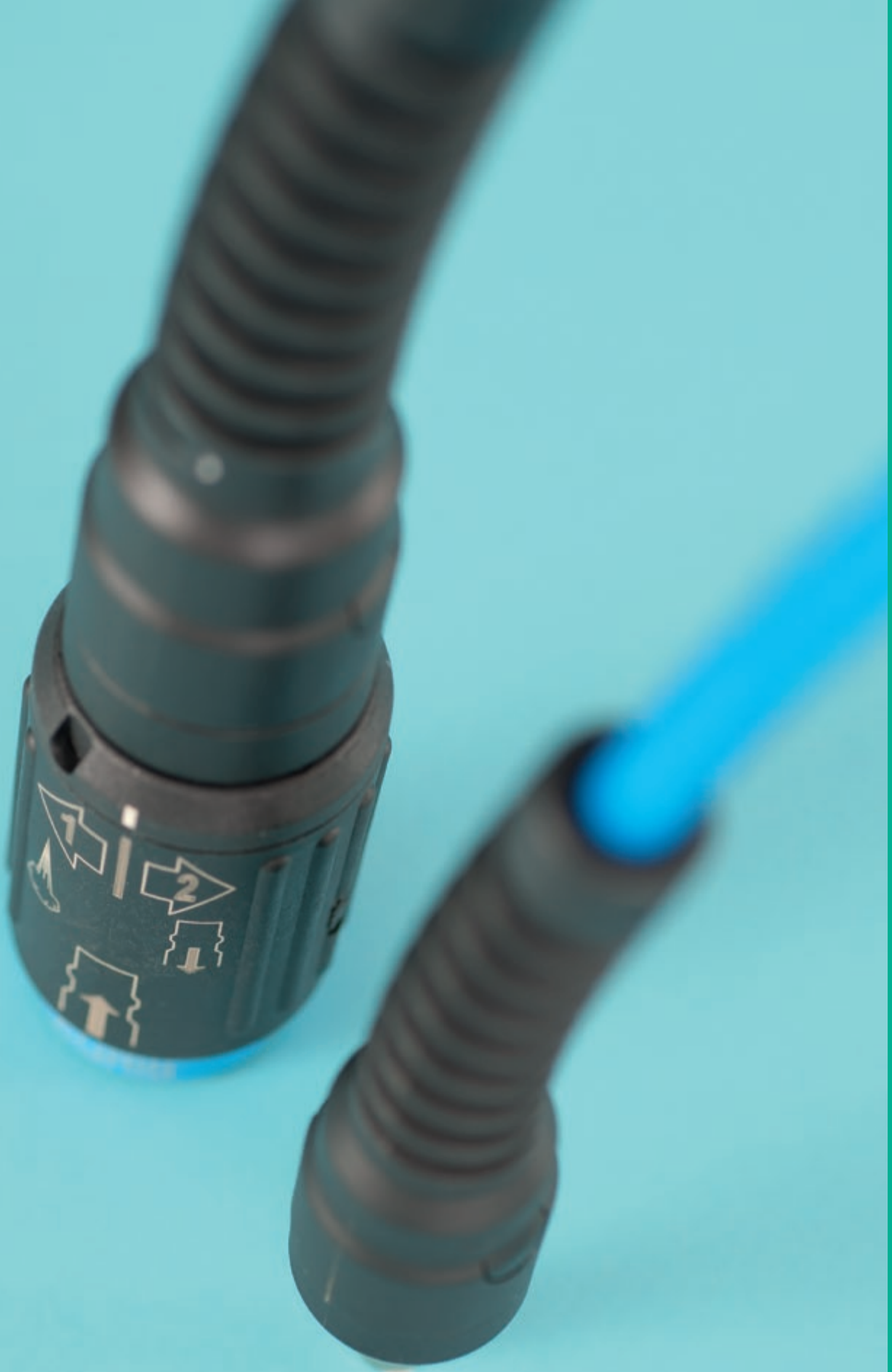

Quick-Acting Couplers

C 9000 Polymer Quick-Acting Safety Couplers (P. 8-7)



Fluids: compressed air

Materials: reinforced technical polymer, nickel-plated brass

Pressure: 16 bar

Temperature: -20°C to +60°C

DN : 5.5 mm to 8 mm

Metal Quick-Acting Couplers (P. 8-19)



Fluids: compressed air, water, industrial fluids

Materials: nickel-plated brass

Pressure: 20 bar

Temperature: -20°C to +100°C

DN : 2 mm to 19 mm

Metal Quick-Acting Couplers Accessories (P. 8-30)



Fluids: industrial fluids

Materials: brass or nickel-plated brass

Pressure: 20 bar

Temperature: -5°C to +60°C

DN : 5,5 mm to 8 mm

3 Shut-Off Functions

Straight-Through

These couplers work without shut-off, meaning they offer maximum flow. Straight-Through couplers are designed to carry fluids such as water, coolants, etc. Before disconnection, the fluid flow must be shut off using a valve located upstream of the coupler.



Single Shut-Off (with or without vent)

On our single shut-off couplers, the male probe is straight-through. The fluid flow can be stopped in the female coupler when disconnected. The circuit can be vented upstream to avoid any risk of whiplash.

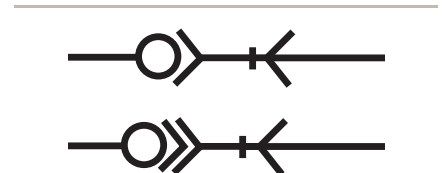

Double Shut-Off

On our double shut-off couplers, after disconnection, flow is prevented both upstream of the female coupler and downstream of the probe. Both sides of the circuit remain under pressure.

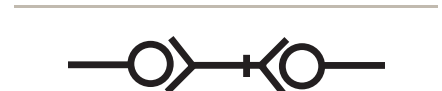

Technology and Flow Rates

The profiles of the Parker Legris quick-acting couplers are manufactured to conform to international standards and are interchangeable with other manufacturers' products meeting these standards.

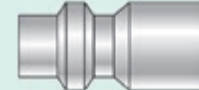
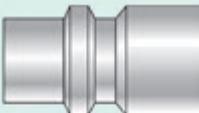
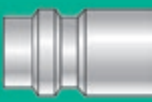
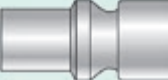
Profile Description	Profile	Interchangeability	Flow (NI/min)	Bore Diameter (mm)
ISO B Standard		C 9000	1250	5.5
		C 9000	2400	8
European Standard		C 9000	2000	7.2
ARO Standard		C 9000	1250	5.5

Quick-Acting Coupler Part Numbers

Standard Product

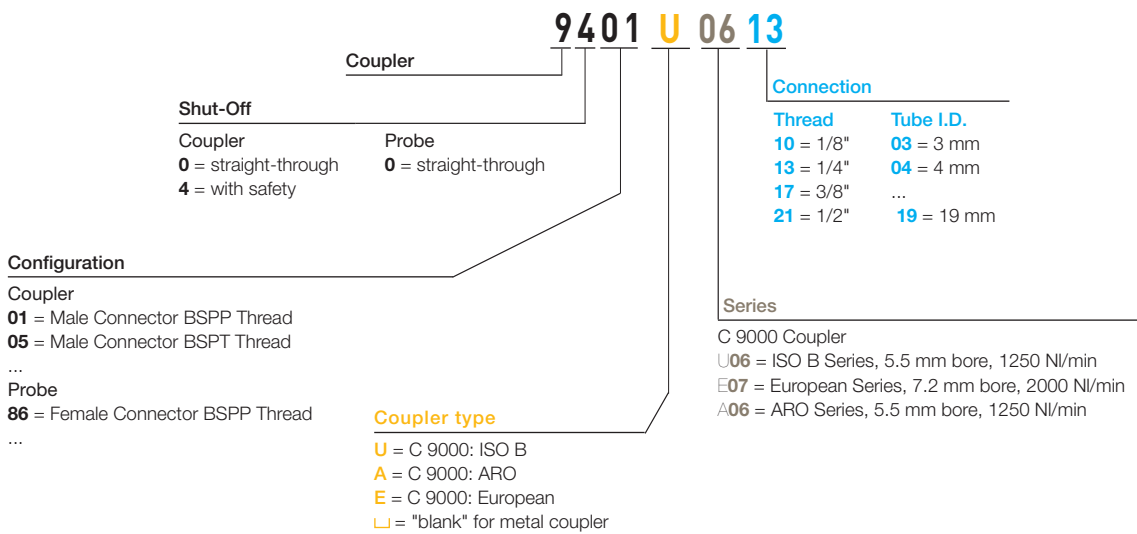

C 9000 Polymer Quick-Acting Safety Coupler Range

C 9000 Polymer Quick-Acting Safety Couplers

ISO B Profile

9401U Page 8-10 **9405U** Page 8-10 **9414U** Page 8-10 **9410U** Page 8-10 **9421U** Page 8-10 **9416U** Page 8-11 **9440U** Page 8-11



9087U Page 8-11 **9086U** Page 8-11 **9080U** Page 8-12 **9094U** Page 8-12



European Profile

9401E Page 8-13 **9414E** Page 8-13 **9410E** Page 8-13 **9421E** Page 8-13 **9416E** Page 8-13 **9440E** Page 8-14



9087E Page 8-14 **9086E** Page 8-14 **9080E** Page 8-14 **9094E** Page 8-14



ARO Profile

9401A Page 8-15 **9405A** Page 8-15 **9414A** Page 8-15 **9410A** Page 8-15 **9421A** Page 8-15 **9416A** Page 8-16 **9440A** Page 8-16



9087A Page 8-16 **9086A** Page 8-16 **9084A** Page 8-16 **9080A** Page 8-17 **9094A** Page 8-17



C 9000 Polymer Quick-Acting Safety Couplers

This range of ergonomic polymer couplers has been designed for **the safety of operators and machinery** while giving very high **energy efficiency performance**. Available in three profile standards, it is perfectly suited for any type of installation.

Product Advantages

- | | |
|---------------------------------|--|
| Safety & Reliability | <ul style="list-style-type: none"> Prevents risk of whiplash Quick-acting vent allowing disconnection to be carried out in total safety Rotating sleeve to avoid risk of accidental disconnection Low connection/disconnection force even under pressure Polymer sleeve protects equipment from scratching Protective spiral over the tube prevents kinking |
| Performance | <ul style="list-style-type: none"> Very high flow and low pressure drop 100% leak-tested in production Date coding to guarantee quality and traceability Robust impact-resistant material Optimum energy efficiency Long-term reliability |
| Easy-to-Use | <ul style="list-style-type: none"> Immediate identification by clear marking on each model showing: <ul style="list-style-type: none"> • profile of the compatible male probe • type part number Compatible with male probes conforming to: <ul style="list-style-type: none"> • ISO B profile • European profile • ARO profile |



Applications

- Workshops
- Cleaning
- Blowing
- Pneumatics
- Air-Operated Tools
- Ring Main Circuits
- Packaging

Technical Characteristics

Compatible Fluids	Compressed air
Working Pressure	0 to 16 bar
Working Temperature	-20°C to +60°C

Regulations

DI: 97/23/EC (PED)
 DI: 2002/95/EC (RoHS), 2011/65/EC
 DI: 1907/2006 (REACH)
 ISO 4414 Pneumatic Fluid Power: General Rules Relating to Systems
 DIN EN 983 Safety Standard for Pneumatics

Component Materials

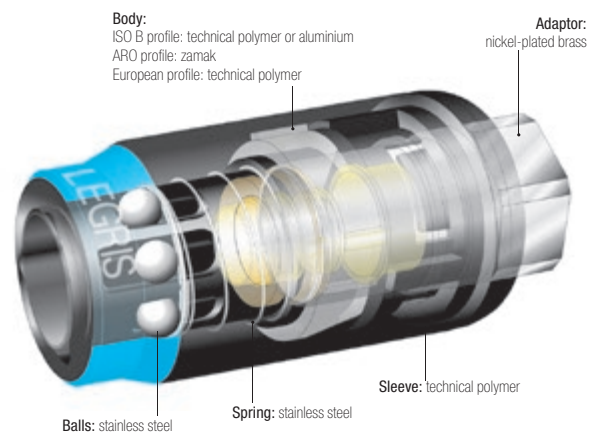

Silicone-free

C 9000 Polymer Quick-Acting Safety Couplers

C 9000 Technology and Flow Rates

"Typical" quick-acting coupler
Standard "poppet" technology
Flow: 1400 NI/min

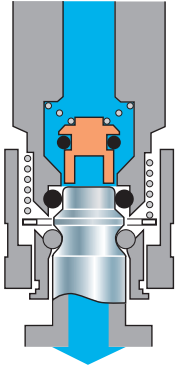

C 9000 quick-acting coupler
"Optimal flow" technology
Flow: 2400 NI/min

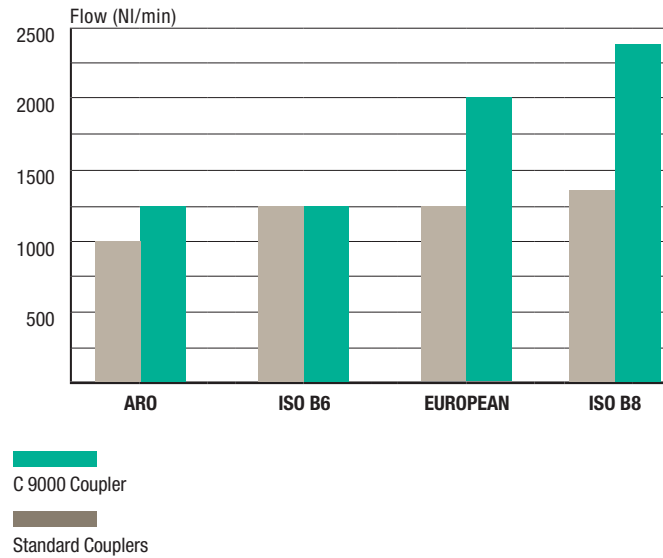
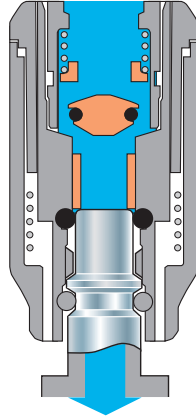

Measurements carried out in accordance with ISO 6358 at a pressure of 6 bar, pressure drop < 0.7 bar

Operation

Operation

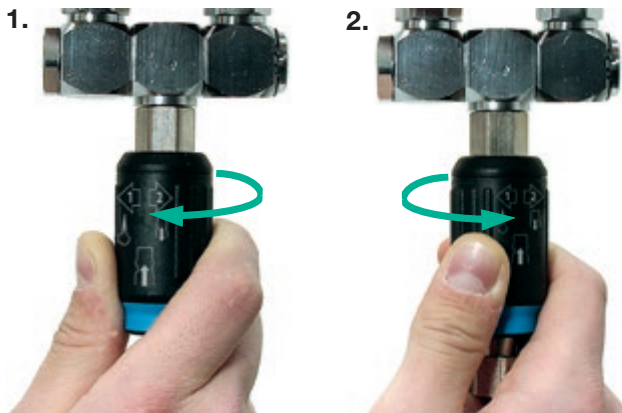

Disconnecting the probe

Rotation, arrow 1: circuit vented on probe side.

Rotation, arrow 2: probe disconnected from the body.

Connecting the probe

The sleeve does not need to be rotated to connect the probe.

Venting Time

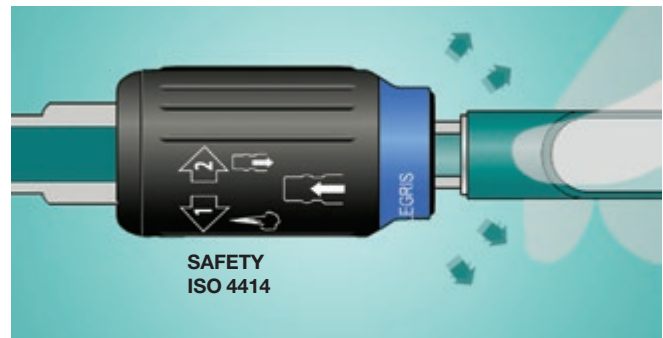

ISO B6 profile, recoil tubing (I.D. 6 mm, length 6 m)

Venting time = 350 ms (transition from 6 bar to 0.2 bar)

ISO B8 profile, PVC tubing (I.D. 10 mm, length 25 m)

Venting time = 860 ms (transition from 6 bar to 0.2 bar)

Even with longer lengths of tubing, the vent time of the C 9000 coupler can be less than 1 second.

ISO B Profile

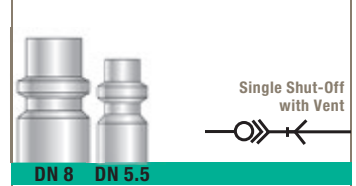

9401U Coupler, Male BSPP Thread

Technical polymer, nickel-plated brass, NBR

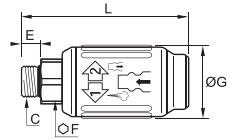

DN	C		E	F	G	L	Kg
5.5	G1/4	9401U06 13	7.5	17	31.5	74	0.075
	G3/8	9401U06 17	8.5	21	31.5	76.5	0.095
	G1/2	9401U06 21	10.5	25	31.5	80	0.115
8	G1/4	9401U08 13	6.5	22	36.5	81.5	0.120
	G3/8	9401U08 17	7.5	22	36.5	82.5	0.133
	G1/2	9401U08 21	9	25	36.5	85.5	0.140

C 9000 Series ISO B (DN 5.5): single shut-off = 1250 NI/min

C 9000 Series ISO B (DN 8): single shut-off = 2400 NI/min

9405U Coupler, Male BSPT Thread

Technical polymer, nickel-plated brass, NBR

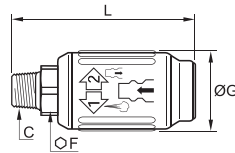

DN	C		F	G	L	Kg
5.5	R1/4	9405U06 13	17	31.5	75	0.075
	R3/8	9405U06 17	19	31.5	76.5	0.095
	R1/2	9405U06 21	22	31.5	81.5	0.110
8	R1/4	9405U08 13	22	36.5	84	0.120
	R3/8	9405U08 17	22	36.5	84	0.120
	R1/2	9405U08 21	22	36.5	88	0.140

C 9000 Series ISO B (DN 5.5): single shut-off = 1250 NI/min

C 9000 Series ISO B (DN 8): single shut-off = 2400 NI/min

9414U Coupler, Female BSPP Thread

Technical polymer, nickel-plated brass, NBR

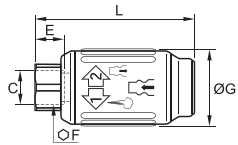

DN	C		E	F	G	L	Kg
5.5	G1/4	9414U06 13	12	17	31.5	66.5	0.070
	G3/8	9414U06 17	12	22	31.5	72	0.085
	G1/2	9414U06 21	15	27	31.5	78	0.115
8	G1/4	9414U08 13	12	22	36.5	75	0.127
	G3/8	9414U08 17	12	22	36.5	75	0.144
	G1/2	9414U08 21	15	27	36.5	80	0.138

C 9000 Series ISO B (DN 5.5): single shut-off = 1250 NI/min

C 9000 Series ISO B (DN 8): single shut-off = 2400 NI/min

9410U Coupler, LF 3000® Push-In Connection, Body Spiral Protection Spring

Technical polymer, nickel-plated brass, NBR

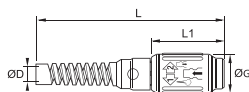

DN	ØD		G	L	L1	Kg
5.5	8	9410U06 08	31.5	145	56	0.096
	10	9410U06 10	31.5	145	56	0.080
8	10	9410U08 10	36.5	155	63	0.175
	12	9410U08 12	36.5	165	63	0.162

C 9000 Series ISO B (DN 5.5): single shut-off = 1250 NI/min

C 9000 Series ISO B (DN 8): single shut-off = 2400 NI/min

9421U Coupler with Hosetail

Technical polymer, nickel-plated brass, NBR

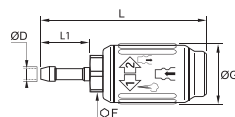

DN	ØD		F	G	L	L1	Kg
5.5	6	9421U06 06	17	31.5	88.5	26	0.070
	8	9421U06 08	17	31.5	88.5	26	0.070
	10	9421U06 10	17	31.5	88.5	26	0.070
8	6	9421U08 06	22	36.5	95	26	0.110
	8	9421U08 08	22	36.5	95	26	0.100
	10	9421U08 10	22	36.5	95	26	0.124
	13	9421U08 13	22	36.5	99	30	0.125

C 9000 Series ISO B (DN 5.5): single shut-off = 1250 NI/min

C 9000 Series ISO B (DN 8): single shut-off = 2400 NI/min

ISO B Profile

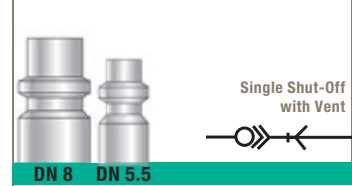

9416U Coupler, Bulkhead Mountable, Female BSPP Thread

Technical polymer, nickel-plated brass, NBR

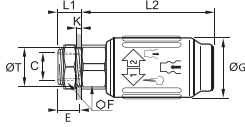

DN	C		E	F	G	K _{max}	L1	L2	ØT _{min}	Kg
5.5	G1/4	9416U06 13	12	22	31.5	6	12.5	68.5	18.5	0.105
8	G3/8	9416U08 17	12	24	36.5	7	14.5	76	22.5	0.150

C 9000 Series ISO B (DN 5.5): single shut-off = 1250 NI/min

C 9000 Series ISO B (DN 8): single shut-off = 2400 NI/min

9440U Y Coupler, Female BSPP Thread

Technical polymer, nickel-plated brass, NBR

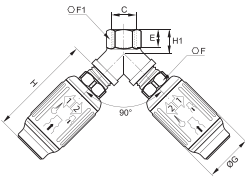

DN	C		E	F	F1	G	H	H1	Kg
5.5	G3/8	9440U06 17	11.5	19	20	31.5	70	16	0.207
8	G1/2	9440U08 21	14	22	25	36.5	80	19	0.352

C 9000 Series ISO B (DN 5.5): single shut-off = 1250 NI/min

C 9000 Series ISO B (DN 8): single shut-off = 2400 NI/min

9087U Probe, Straight-Through, Male BSPP Thread

Nickel-plated steel, technical polymer

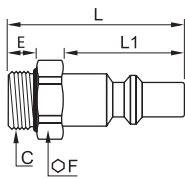

DN	C		E	F	L	L1	Kg
5.5	G1/4	9087U06 13	9	13	39	24	0.026
	G3/8	9087U06 17	9	17	38	24	0.032
	G1/2	9087U06 21	9	19	39	24	0.048
8	G1/4	9087U08 13	9	17	38	24	0.030
	G3/8	9087U08 17	9	19	39	24	0.036
	G1/2	9087U08 21	12	22	42	24	0.058

Probe without shut-off

9086U Probe, Straight-Through, Female BSPP Thread

Treated steel

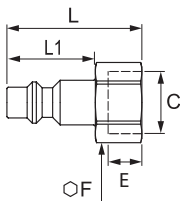

DN	C		E	F	L	L1	Kg
5.5	G1/4	9086 23 13	9	17	36	24	0.025
	G3/8	9086 23 17	9	19	36	24	0.025
	G1/2	9086 23 21	12	24	39	24	0.039

Probe without shut-off

9086U Probe, Straight-Through, Female BSPP Thread

Nickel-plated steel

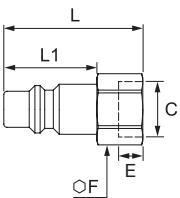

DN	C		E	F	L	L1	Kg
8.5	G1/4	9086 30 13	10	17	40	28	0.032
	G3/8	9086 30 17	10	19	42	28	0.035
	G1/2	9086 30 21	12	24	43	28	0.046

Probe without shut-off

C 9000 Series probe (DN 8.5) compatible with ISO B Series C 9000 couplers (DN 8)

ISO B Profile

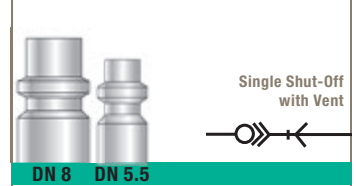

9080U Probe, Straight-Through, LF 3000® Push-In Connection, with Spiral Protection Spring

Nickel-plated steel, NBR

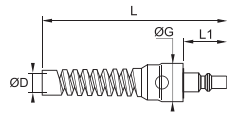

DN	ØD		G	L	L1	Kg
5.5	8	9080U06 08	24	112	24	0.052
	10	9080U06 10	24	112	24	0.044
8	10	9080U08 10	24	114	26	0.095
	12	9080U08 12	29.5	125	26	0.096

Probe without shut-off

9094U Probe, Straight-Through, with Hosetail

Nickel-plated steel

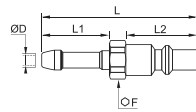

DN	ØD		F	L	L1	L2	Kg
5.5	6	9094U06 06	14	51	24	25	0.016
	8	9094U06 08	14	51	27	25	0.017
	10	9094U06 10	14	51	24	25	0.018
8	8	9094U08 08	17	51	24	25	0.027
	10	9094U08 10	17	51	27	25	0.028
	13	9094U08 13	17	51	24	25	0.031

Probe without shut-off

European Profile

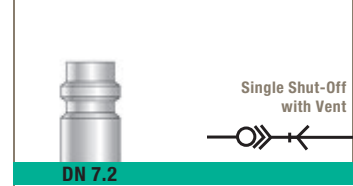

9401E Coupler, Male BSPP Thread

Technical polymer, nickel-plated brass, NBR

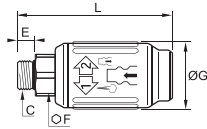

DN	C		E	F	G	L	Kg
7.2	G1/4	9401E07 13	6.5	22	36.5	80	0.124
	G3/8	9401E07 17	7.5	22	36.5	81	0.122
	G1/2	9401E07 21	9	25	36.5	83.5	0.136

C 9000 Series: single shut-off = 2000 NI/min

9414E Coupler, Female BSPP Thread

Technical polymer, nickel-plated brass, NBR

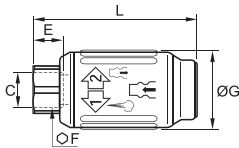

DN	C		E	F	G	L	Kg
7.2	G1/4	9414E07 13	12	22	36.5	73	0.118
	G3/8	9414E07 17	12	22	36.5	73	0.109
	G1/2	9414E07 21	15	27	36.5	78	0.130

C 9000 Series: single shut-off = 2000 NI/min

9410E Coupler, LF 3000® Push-In Connection, with Spiral Protection Spring

Technical polymer, nickel-plated brass, NBR

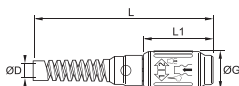

DN	ØD		G	L	L1	Kg
7.2	10	9410E07 10	36.5	151	63	0.175
	12	9410E07 12	36.5	151	63	0.180

C 9000 Series: single shut-off = 2000 NI/min

9421E Coupler with Hosetail

Technical polymer, nickel-plated brass, NBR

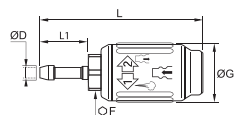

DN	ØD		F	G	L	L1	Kg
7.2	8	9421E07 08	22	36.5	93	26	0.113
	10	9421E07 10	22	36.5	93	26	0.114
	13	9421E07 13	22	36.5	97	30	0.119

C 9000 Series: single shut-off = 2000 NI/min

9416E Coupler, Bulkhead Mountable, Female BSPP Thread

Technical polymer, nickel-plated brass, NBR

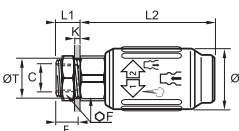

DN	C		E	F	G	K _{max}	L1	L2	ØT _{min}	Kg
7.2	G3/8	9416E07 17	12	24	36.5	7	14.5	74	22.5	0.153

C 9000 Series: single shut-off = 2000 NI/min

European Profile

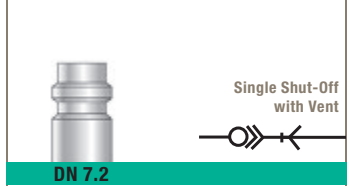

9440E Y Coupler, Female BSPP Thread

Technical polymer, nickel-plated brass, NBR

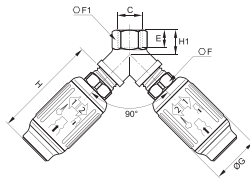

DN	C		E	F	F1	G	H	H1	Kg
7.2	G1/2	9440E07 21	14	25	25	36.5	78	19	0.335

C 9000 Series: single shut-off = 2000 NI/min

9087E Probe, Straight-Through, Male BSPP Thread

Nickel-plated steel, technical polymer

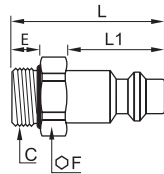

DN	C		E	F	L	L1	Kg
7.2	G1/4	9087E07 13	9	14	34	20	0.018
	G3/8	9087E07 17	9	17	34	20	0.025
	G1/2	9087E07 21	12	22	38	20	0.048

Probe without shut-off

9086E Probe, Straight-Through, Female BSPP Thread

Nickel-plated steel

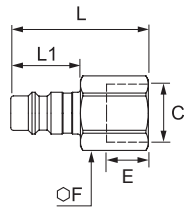

DN	C		E	F	L	L1	Kg
7.4	G1/8	9086 25 10	7	14	32	20	0.016
	G1/4	9086 25 13	9	17	38.5	20	0.027
	G3/8	9086 25 17	9	19	33	20	0.027
	G1/2	9086 25 21	12	24	36	20	0.048

Probe without shut-off

9080E Probe, Straight-Through, LF 3000® Push-In Connection, with Spiral Protection Spring

Nickel-plated steel, NBR

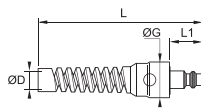

DN	ØD		G	L	L1	Kg
7.2	10	9080E07 10	24	114	20	0.102
	12	9080E07 12	29.5	125	20	0.088

Probe without shut-off

9094E Probe, Straight-Through, with Hosetail

Nickel-plated steel

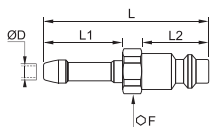

DN	ØD		F	L	L1	L2	Kg
7.2	8	9094E07 08	17	48	20	25	0.015
	10	9094E07 10	17	48	20	25	0.016
	13	9094E07 13	17	48	20	25	0.020

Probe without shut-off

ARO Profile

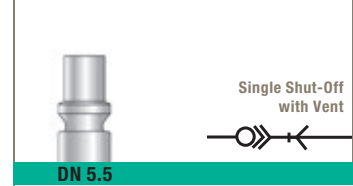

9401A Coupler, Male BSPP Thread

Technical polymer, nickel-plated brass, NBR

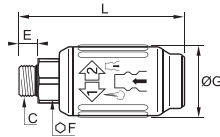

DN	C		E	F	G	L	Kg
5.5	G1/4	9401A06 13	6.5	17	31.5	70.5	0.105
	G3/8	9401A06 17	9	21	31.5	73.5	0.123
	G1/2	9401A06 21	9	25	31.5	70.5	0.150

C 9000 Series: single shut-off = 1250 NI/min

9405A Coupler, Male BSPT Thread

Technical polymer, nickel-plated brass, NBR

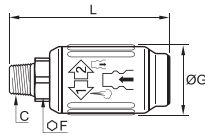

DN	C		F	G	L	Kg
5.5	R1/4	9405A06 13	17	31.5	73	0.105
	R3/8	9405A06 17	19	31.5	74.5	0.110
	R1/2	9405A06 21	22	31.5	79.5	0.140

C 9000 Series: single shut-off = 1250 NI/min

9414A Coupler, Female BSPP Thread

Technical polymer, nickel-plated brass, NBR

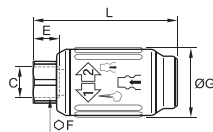

DN	C		E	F	G	L	Kg
5.5	G1/4	9414A06 13	12	17	31.5	64.5	0.095
	G3/8	9414A06 17	12	22	31.5	70	0.115
	G1/2	9414A06 21	15	27	31.5	76	0.145

C 9000 Series: single shut-off = 1250 NI/min

9410A Coupler, LF 3000® Push-In Connection, with Spiral Protection Spring

Technical polymer, nickel-plated brass, NBR

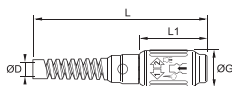

DN	ØD		G	L	L1	Kg
5.5	8	9410A06 08	31.5	143	54	0.140
	10	9410A06 10	31.5	143	54	0.175

C 9000 Series: single shut-off = 1250 NI/min

9421A Coupler with Hosetail

Technical polymer, nickel-plated brass, NBR

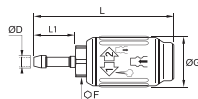

DN	ØD		F	G	L	L1	Kg
5.5	6	9421A06 06	17	31.5	86.5	26	0.110
	8	9421A06 08	17	31.5	86.5	26	0.100
	10	9421A06 10	17	31.5	86.5	26	0.100

C 9000 Series: single shut-off = 1250 NI/min

ARO Profile

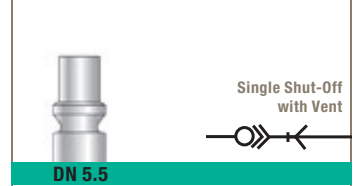

9416A Coupler, Bulkhead Mountable, Female BSPP Thread

Technical polymer, nickel-plated brass, NBR

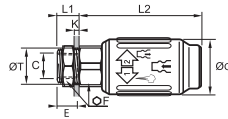

DN	C		E	F	G	K	L1	L2	ØT	Kg
5.5	G1/4	9416A06 13	12	22	31.5	6	12.5	66.5	18.5	0.135

C 9000 Series: single shut-off = 1250 NI/min

9440A Y Coupler, Female BSPP Thread

Technical polymer, nickel-plated brass, NBR

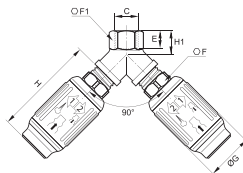

DN	C		E	F	F1	G	H	H1	Kg
5.5	G3/8	9440A06 17	11.5	19	20	31.5	68	16	0.263

C 9000 Series: single shut-off = 1250 NI/min

9087A Probe, Straight-Through, Male BSPP Thread

Nickel-plated steel, technical polymer

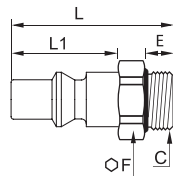

DN	C		E	F	L	L1	Kg
5.5	G1/4	9087A06 13	9	17	36	22	0.020
	G3/8	9087A06 17	9	19	36	22	0.024
	G1/2	9087A06 21	12	24	40	22	0.050

Probe without shut-off

9086A Probe, Straight-Through, Female BSPP Thread

Nickel-plated steel

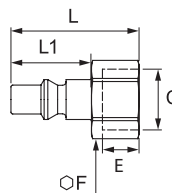

DN	C		E	F	L	L1	Kg
5.5	G1/4	9086 22 13	9	17	35.5	22	0.024
	G3/8	9086 22 17	10	19	35.5	22	0.023
	G1/2	9086 22 21	12	24	38	22	0.039

Probe without shut-off

9084A Probe, Straight-Through, Male BSPT Thread

Nickel-plated steel

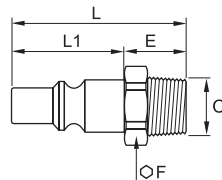

DN	C		F	L	L1	Kg
5.5	R1/4	9084 22 13	14	40.5	22	0.020
	R3/8	9084 22 17	17	40.5	22	0.031
	R1/2	9084 22 21	22	46	22	0.048

Probe without shut-off

ARO Profile

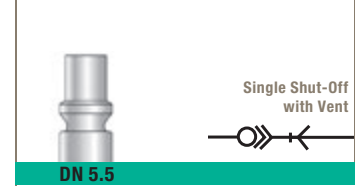

9080A Probe, Straight-Through, LF 3000® Push-In Connection, with Spiral Protection Spring

Nickel-plated steel, NBR

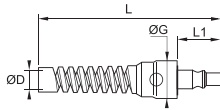

DN	ØD		G	L	L1	Kg
5.5	8	9080A06 08	24	118	22	0.028
	10	9080A06 10	24	118	22	0.027

Probe without shut-off

9094A Probe, Straight-Through, with Hosetail

Nickel-plated steel

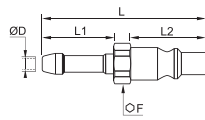

DN	ØD		F	L	L1	L2	Kg
5.5	6	9094A06 06	14	48.5	22	25	0.013
	8	9094A06 08	14	48.5	22	25	0.014
	10	9094A06 10	14	48.5	22	25	0.017

Probe without shut-off



Metal Quick-Acting Coupler Range

Nickel-Plated Brass Quick-Acting Couplers

Mini Series



Standard Series



Midi Series



Maxi Series



Metal Quick-Acting Coupler Accessories



Metal Quick-Acting Couplers

In order to fulfill the requirements of the **widest range of industrial applications**, Parker Legris offers a range of metal couplers compatible with a large selection of fluids.

Simple to install, with or without shut-off valves, these couplers offer a **high flow rate capability**.

Product Advantages

Easy-to-Use | Coupler with sliding sleeve: automatic connection and disconnection
 Extremely compact
 Single or double shut-off models for greater safety
 Special range designed for pneumatic applications: mini and standard series
 Special range designed for the transmission of water and fluids: midi and maxi series

Robust & Reliable | 100% leak-tested in production
 Excellent shock and impact resistance
 Nickel-plated brass for corrosion resistance

Optimum Performance | Very wide range of flow rates
 Low pressure drop
 Long service life
 Maximum energy efficiency



Applications
 Workshops
 Flushing
 Spraying
 Packaging
 Factory Automation
 Filling Systems
 Cleaning

Technical Characteristics

Compatible Fluids	Compressed air, water
Working Pressure	0 to 20 bar
Working Temperature	-20°C to +100°C

Guaranteed for use with a vacuum of 655 mm Hg (86% vacuum).

Component Materials

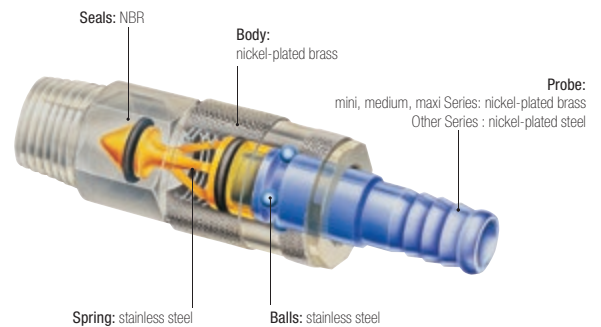

Silicone-free

Metal Quick-Acting Couplers

Metal Quick-Acting Coupler Technology and Flow Rates

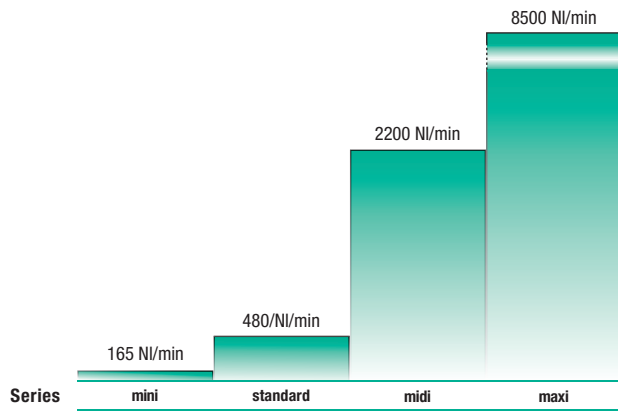

Measurements carried out in accordance with ISO 6358 at a pressure of 6 bar, pressure drop < 0.7 bar (single shut-off flow)

3 Shut-Off Functions

Straight-Through

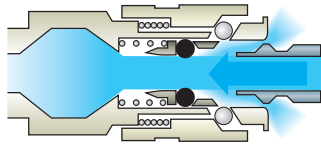

Single Shut-Off

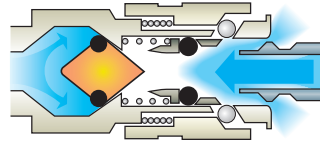

Single shut-off coupler
+ probe without shut-off
When disconnected, the fluid path is closed upstream (body side).

Double Shut-Off

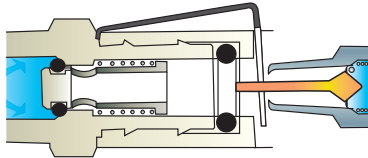

Double shut-off coupler
+ probe with shut-off
When disconnected, the fluid path is closed upstream (body side) and downstream (probe side).

Operation



Mini Series

Single Shut-Off



Double Shut-Off



0171 Coupler, Male BSPT and Parallel Metric Thread

Technical polymer, nickel-plated brass, NBR

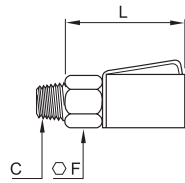

DN	C		E	F	L	Kg
2	M7x1	0171 02 55 01	6	10	21	0.007
		0171 02 10 01	7.5	10	21	0.010
2	R1/8	0171 02 10 02	7.5	10	21	0.010
		0171 02 10 03	7.5	10	21	0.010
		0171 02 10 04	7.5	10	21	0.010
		0171 02 10 05	7.5	10	21	0.010

Single shut-off

Mini Series (DN 2): single shut-off= 165 NI/min

0183 Probe, Valved, Male BSPT Thread

Nickel-plated brass, NBR

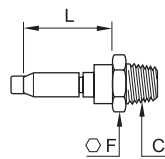

DN	C		F	L	Kg
2	R1/8	0183 02 10	10	13	0.007

Probe with shut-off

0184 Probe, Straight-Through, Male BSPT Thread

Nickel-plated brass

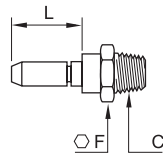

DN	C		F	L	Kg
2	R1/8	0184 02 10	10	13	0.006

Probe without shut-off

0181 Probe without shut-off, Male BSPT Thread

Nickel-plated brass

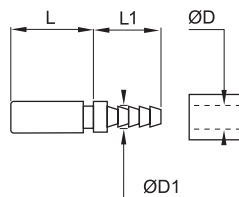

DN	ØD	ØD1		L	L1	Kg
2	3	3.3	0181 03 04	11.5	13.5	0.010

Probe without shut-off

Mini Series

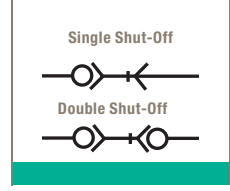

0171 Coupler, Straight-Through, Male BSPT Thread

Technical polymer, nickel-plated brass, NBR

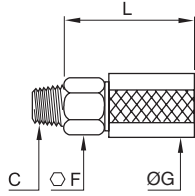

DN	C		F	G	L	Kg
3	R1/8	0171 03 10 01	13	17	24.5	0.020
		0171 03 10 02	13	17	24.5	0.020
		0171 03 10 03	13	17	24.5	0.020
		0171 03 10 04	13	17	24.5	0.020
		0171 03 10 05	13	17	24.5	0.020

Straight-through

0181 Probe, Straight-Through with Barb Connection for Polyamide (PA) Tubing

Nickel-plated brass

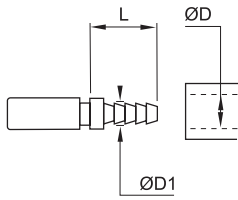

DN	ØD	ØD1		L	Kg
3	4	4.7	0181 04 06	19	0.005

Probe without shut-off

0180 Probe, Straight-Through with Barb Connection for Flexible Tubing

Nickel-plated brass

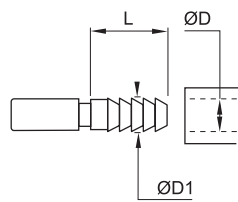

DN	ØD	ØD1		L	Kg
3	4	6	0180 04 00	19	0.007
	5	6.5	0180 05 00	19	0.007

Probe without shut-off

3150 Probe, Straight-Through with LF 3000® Push-In Connection

Nickel-plated brass, NBR

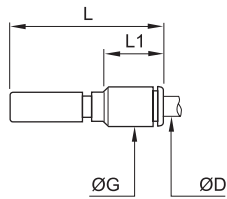

DN	ØD		G	L	L1	Kg
3	4	3150 00 61	8.5	39	18	0.008

Probe without shut-off

Standard Series

Single Shut-Off



0172 Coupler, Female BSPP Thread

Nickel-plated brass, NBR

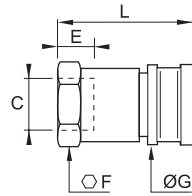

DN	C		E	F	G	L	Kg
5	G1/4	0172 05 13	11	19	21	47	0.086

Standard Series: single shut-off = 480 NI/min

0187 Probe, Straight-Through, Male BSPP Thread

Zinc-plated blister steel

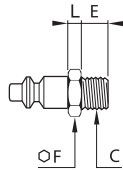

DN	C		E	F	L	Kg
5	G1/8	0187 05 10	7	14	4	0.018
	G1/4	0187 05 13	9.5	17	5	0.027

Probe without shut-off

0186 Probe, Straight-Through, Female BSPP Thread

Zinc-plated blister steel

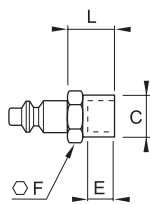

DN	C		E	F	L	Kg
5	G1/4	0186 05 13	12	17	17	0.027

Probe without shut-off

0185 Probe, Straight-Through, with Barb Connection for Flexible Tubing

Zinc-plated blister steel

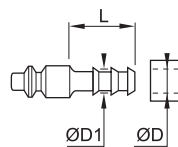

DN	ØD	ØD1		L	Kg
5	4	6	0185 04 00	22.5	0.014
	7	9	0185 07 00	22.5	0.017
	10	12.2	0185 10 00	22.5	0.013

Probe without shut-off

0189 Double Probe

Zinc-plated blister steel

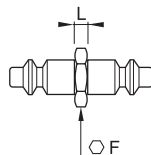

DN		F	L	Kg
5	0189 05 00	12	4	0.025

Probe without shut-off

Midi Series

Without Shut-Off



Single Shut-Off



0172 Coupler, Female BSPP Thread

Nickel-plated brass, NBR

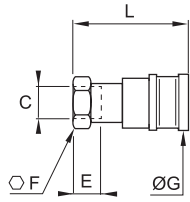

DN	C		E	F	G	L	Kg
12	G3/8	0172 12 17	16	27	29	56	0.155
	G1/2	0172 12 21	16	27	29	56	0.142

Midi Series: single shut-off = 2200 NI/min

2272 Coupler, Straight-Through, Female BSPP Thread

Nickel-plated brass, NBR

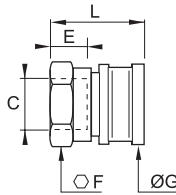

DN	C		E	F	G	L	Kg
12	G1/2	2272 12 21	10	24	29	33	0.066
	G3/4	2272 12 27	10	30	29	34.5	0.074
	G1	2272 12 34	10	36	29	34.5	0.081

2511 Coupler with Barb Connection for Hose

Nickel-plated brass, NBR

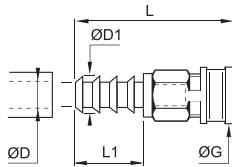

DN	ØD	ØD1		G	L	L1	Kg
12	12	13.5	2511 12 12	29	75	32	0.145
	15	16.5	2511 12 15	29	75	32	0.147
	19	20.5	2511 12 19	29	81	38	0.160

Midi Series: single shut-off = 2200 NI/min

2297 Coupler, Straight-Through, with Barb Connection for Hose

Nickel-plated brass, NBR

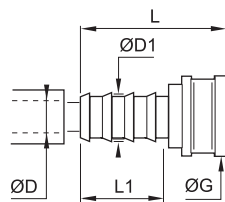

DN	ØD	ØD1		G	L	L1	Kg
12	12	13.5	2297 12 12	29	51	27	0.072
	15	16.5	2297 12 15	29	51	27	0.075
	19	20.5	2297 12 19	29	57	33	0.092

2294 Probe, Straight-Through, Male BSPP Thread

Nickel-plated brass

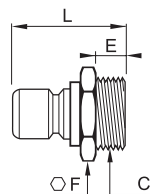

DN	C		E	F	L	Kg
12	G3/8	2294 12 17	6	22	31.5	0.031
	G1/2	2294 12 21	9.5	22	37	0.044
	G3/4	2294 12 27	13.5	27	41	0.068
	G1	2294 12 34	10.5	34	36	0.071

Probe without shut-off

Midi Series

Without Shut-Off



Single Shut-Off

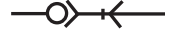

0196 Probe, Straight-Through, Female BSPP Thread

Nickel-plated brass

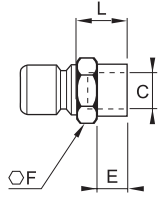

DN	C		E	F	L	Kg
12	G1/4	0196 12 13	12	17	16	0.027
	G3/8	0196 12 17	12	21	15	0.034
	G1/2	0196 12 21	14	26	17	0.051

Probe without shut-off

2296 Probe, Straight-Through, Female BSPP Thread

Nickel-plated brass

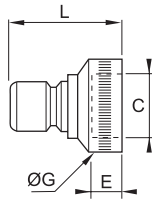

DN	C		E	G	L	Kg
12	G1/2	2296 12 21	11	24	31.5	0.031
	G3/4	2296 12 27	11	30	38	0.058
	G1	2296 12 34	11	36	36.5	0.059

Probe without shut-off

0195 Probe, Straight-Through, with Barb Connection for Flexible Tubing

Nickel-plated brass

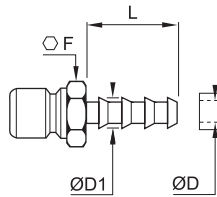

DN	ØD	ØD1		F	L	Kg
12	7	9	0195 07 00	17	29.5	0.027
	10	12.2	0195 10 00	17	29.5	0.028
	13	15.2	0195 13 00	17	29.5	0.030
	16	18.5	0195 16 00	21	36.5	0.048

Probe without shut-off

2295 Probe, Straight-Through, with Barb Connection for Flexible Hose

Nickel-plated brass

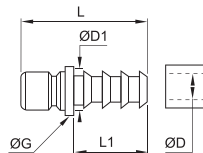

DN	ØD	ØD1		G	L	L1	Kg
12	12	13.5	2295 12 12	17	48	27	0.025
	15	16.5	2295 12 15	18	48	27	0.033
	19	20.5	2295 12 19	24	57	33	0.053

Probe without shut-off

2293 Y Coupler, Straight-Through

Nickel-plated brass, NBR

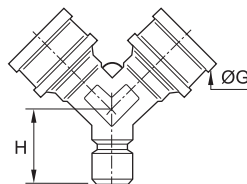

DN		G	H	Kg
12	2293 12 00	29	27	0.132

Probe without shut-off

Midi Series: straight-through = 2200 NI/min

Midi Series

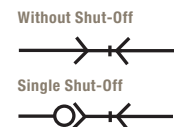

2270 Coupler with Tap, Male BSP Thread

Nickel-plated brass, NBR

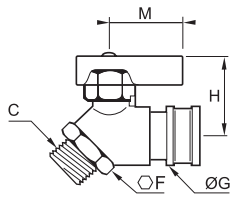

DN	C		F	G	H	M	Kg
12	G1/2	2270 21 00	28	29	40.5	35	0.278

Flow = 2200 NI/min

2203 Plug

Nickel-plated brass

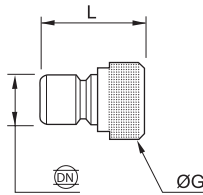

DN		G	L	Kg
12	2203 12 00	20	34	0.042

2292 Universal Coupler Adaptor

Nickel-plated brass, NBR

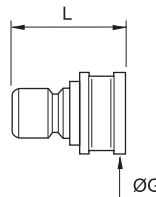

DN		G	L	Kg
12	2292 12 00	29	40.5	0.083

Without shut-off

This adaptor provides interchangeability with numerous components (especially watering accessories).

2398 Universal Probe Adaptor

Nickel-plated brass, NBR

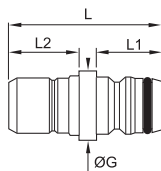

DN		G	L	L1	L2	Kg
12	2398 12 01	20	43	19	18.5	0.035

This adaptor provides interchangeability with numerous components (especially watering accessories).

Midi Series

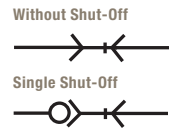

2299 Water Pistol

Zamak, nickel-plated brass, NBR

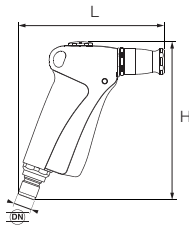

12 **2299 12 01**

H L Kg

140 126 0.468

This pistol allows independent control of:

- the flow rate (trigger)
- type of jet (adjustable to a fine mist) by the adjustable probe

2299 Adjustable Nozzle

Nickel-plated brass, NBR

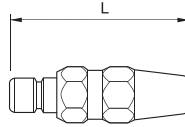

12 **2299 12 20**

L Kg

77.4 0.137

This nozzle allows adjustment of the spray.

Maxi Series

Without Shut-Off



2272 Coupler, Straight-Through, Female BSPP Thread

Nickel-plated brass, NBR

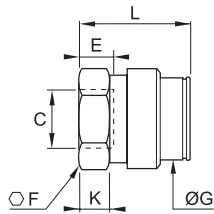

DN	C		E	F	G	K	L	Kg
19	G1	2272 18 34	9	36	42	11	45	0.181

Maxi Series: straight-through = 8500 NI/min

2297 Coupler, Straight-Through with Barb Connection for Hose

Nickel-plated brass, NBR

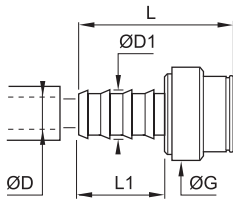

DN	ØD	ØD1		G	L	L1	Kg
19	19	20.7	2297 18 20	39.5	69	37	0.163

Maxi Series: straight-through = 8500 NI/min

2294 Coupler, Straight-Through, Male BSPP Thread

Nickel-plated brass

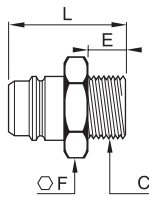

DN	C		E	F	L	Kg
19	G3/4	2294 18 27	10.5	27	42.5	0.070
	G1	2294 18 34	13	34	46	0.102

Probe without shut-off

2295 Coupler, Straight-Through with Barb Connection for Flexible Hose

Nickel-plated brass

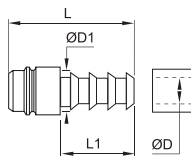

DN	ØD	ØD1		L	L1	Kg
19	19	21	2295 18 20	69	41	0.068

Probe without shut-off

Quick-Acting Coupler Accessories

Parker Legris has developed a range of accessories for quick-acting couplers which save time, **match the product** to the application and **increase the life** of the equipment.

Product Advantages

Performance | Interchangeability with ISO B probe profile
 Avoids tube twisting
 Facilitates use by following movements
 Robust

Adaptable | Two models depending on the application:
 Oscillating fittings:
 • angled at 45° and fitted with a ball bearing
 • effortless rotation through 360°
 Flexible fittings:
 • fitted with a ball joint mounted on a lubricated plastic seat
 • single connection providing an angle of rotation of 70°
 • multiple tees (three connections) providing an angle of rotation of 360°



Pneumatics
 Water
 Workshops
 Industrial Machinery

Applications

Technical Characteristics

Compatible Fluids	Industrial fluids
Working Pressure	Oscillating fittings: 0 to 15 bar Flexible fittings: 0 to 10 bar Swivelling multiple tees: 0 to 20 bar
Working Temperature	-5°C to +60°C

Component Materials

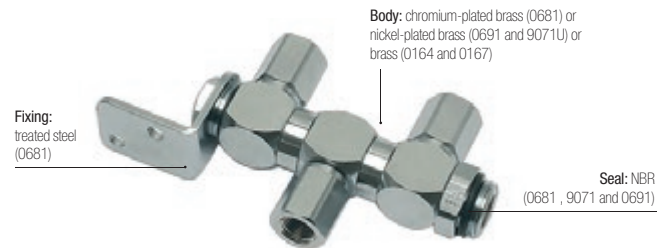

Other accessories are available on request:

- ISO B rotary fitting, male BSPT
- ISO B jointed fitting, male BSPP
- multiple tee with 2 outlets, female male BSPP



Quick-Acting Coupler Accessories

9071U Oscillating ISO B Probe, Male BSPP Thread

Treated steel, NBR

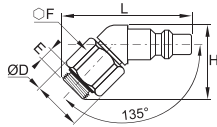

DN	C		E	F	H	L	Kg
6	G1/4	9071U06 13	5.5	19	30	52	0.066
8	G1/4	9071U08 13	5.5	19	30	52	0.064

200 parts per box (minimum of order)

0691 Flexible Fitting, Female/Male BSPP Thread

Treated steel, NBR

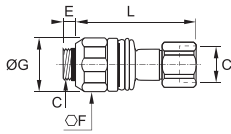

DN	C		E	F	G	L	Kg
5.5	G1/4	0691 13 13	5.5	24	25.5	56	0.090

NBR Sleeve

0681 Multiple Tee with 3 Female Outlets, Male/Female BSPP Thread

Chromium-plated brass, NBR

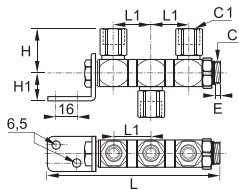

C	C1		E	H	H1	L	L1	Kg
G1/2	G1/4	0681 13 21	7.5	36	24	138.5	30	0.430

0164 Adaptor, Male NPT/Female BSPP Thread

Brass

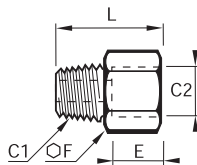

C1	C2		E	F	L	Kg
NPT1/8	G1/8	0164 11 10	7.5	14	20	0.015
NPT1/4	G1/4	0164 14 13	11	17	27.5	0.028
NPT3/8	G3/8	0164 18 17	11.5	22	28.5	0.044
NPT1/2	G1/2	0164 22 21	15	27	36.5	0.082
NPT3/4	G3/4	0164 28 27	16.5	32	38.5	0.110

Adaptor for female socket of quick-acting mould couplers

0167 Adaptor, Male BSPT/Female NPT Thread

Brass

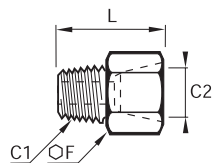

C1	C2		F	L	Kg
R1/8	NPT1/8	0167 10 11	14	21	0.016
R1/4	NPT1/4	0167 13 14	17	28.5	0.029
R3/8	NPT3/8	0167 17 18	22	29.5	0.047
R1/2	NPT1/2	0167 21 22	27	37.5	0.088
R3/4	NPT3/4	0167 27 28	32	39.5	0.120

Adaptor for female socket of quick-acting mould couplers

Adaptors and Manifolds



A Complete Range of Adaptors

Brass Adaptors

0143 BSPP Page 9-7	0144 BSPT/BSPP Page 9-7	0152 BSPT Page 9-7	0145 BSPP Page 9-7	MR0434 BSPP/BSPT Page 9-7	0158 BSPT/BSPP Page 9-8	0117 BSPP Page 9-8	207ACBH NPTF Page 9-8	0155 BSPP Page 9-8	GG-B NPTF Page 9-9	207P NPTF Page 9-9	0164 NPT/BSPP Page 9-9
---------------------------------	--------------------------------------	---------------------------------	---------------------------------	--	--------------------------------------	---------------------------------	------------------------------------	---------------------------------	---------------------------------	---------------------------------	-------------------------------------



0167 BSPT/NPT Page 9-9	0168 BSPP Page 9-9	0163 BSPT/BSPP Page 9-10	209P NPTF Page 9-10	0169 BSPP Page 9-10	FG43 BSPP/BSPT Page 9-10	222P NPTF Page 9-11	0121 BSPT Page 9-11	FF44 BSPP Page 9-11	0121 NPT/BSPT Page 9-11	216P NPTF Page 9-12	0929 BSPT Page 9-12
-------------------------------------	---------------------------------	---------------------------------------	----------------------------------	----------------------------------	---------------------------------------	----------------------------------	----------------------------------	----------------------------------	--------------------------------------	----------------------------------	----------------------------------



0123 BSPT Page 9-12	0136 BSPT Page 9-13
----------------------------------	----------------------------------



Nickel-Plated Brass Adaptors

0912 BSPP/Metric Page 9-14	DD44BKTL BSPP Page 9-14	0921 Metric Page 9-14	0913 BSPT/BSPP Page 9-14	0922 Metric Page 9-14	0914 BSPT Page 9-15	0910 BSPP Page 9-15	0911 BSPT/BSPP Page 9-15	0915 BSPP/Metric Page 9-15	0923 Metric Page 9-15	0916 BSPT/BSPP Page 9-16	0924 Metric Page 9-16
---	--------------------------------------	------------------------------------	---------------------------------------	------------------------------------	----------------------------------	----------------------------------	---------------------------------------	---	------------------------------------	---------------------------------------	------------------------------------



0917 BSPT/BSPP Page 9-16	0927 BSPT Page 9-16	0928 BSPT/BSPP Page 9-16	0932 BSPT/BSPP Page 9-17	0908 BSPP Page 9-17	0909 BSPT/BSPP Page 9-17	KRRS3 BSPT Page 9-17	0903 BSPP/BSPT Page 9-17	0904 BSPT/BSPP Page 9-18	0905 BSPP/Metric Page 9-18	0906 BSPP/Metric Page 9-18	0933 BSPT/BSPP Page 9-18
---------------------------------------	----------------------------------	---------------------------------------	---------------------------------------	----------------------------------	---------------------------------------	-----------------------------------	---------------------------------------	---------------------------------------	---	---	---------------------------------------



0907 BSPP Page 9-19	0920 BSPP/Metric Page 9-19	0900 BSPT Page 9-19	0901 BSPP/Metric Page 9-19	0192 BSPT/BSPP Page 9-20	0902 BSPP/Metric Page 9-20	0191 BSPP Page 9-20	0931 BSPP Page 9-20	0934 BSPT Page 9-21	0935 BSPP Page 9-21
----------------------------------	---	----------------------------------	---	---------------------------------------	---	----------------------------------	----------------------------------	----------------------------------	----------------------------------



Stainless Steel Adaptors

1844 BSPT/BSPP Page 9-22	1843 BSPP Page 9-22	1845 BSPP Page 9-22	1817 BSPP Page 9-22	1871 NPT Page 9-22	1855 BSPP Page 9-23	1870 NPT Page 9-23	1862 BSPP Page 9-23	1864 NPT/BSPP Page 9-23	1867 BSPT/NPT Page 9-23	1863 BSPT/BSPP Page 9-24	1872 NPT Page 9-24
---------------------------------------	----------------------------------	----------------------------------	----------------------------------	---------------------------------	----------------------------------	---------------------------------	----------------------------------	--------------------------------------	--------------------------------------	---------------------------------------	---------------------------------



1861 BSPT/BSPP Page 9-24	1873 NPT Page 9-24	1821 BSPT Page 9-24	1821 NPT Page 9-25	1823 BSPT Page 9-25	1823 NPT Page 9-25
---------------------------------------	---------------------------------	----------------------------------	---------------------------------	----------------------------------	---------------------------------



A Complete Range of Manifolds, Plugs and Accessories

Brass and Aluminium Manifolds

0135 BSPP brass Page 9-26	3310 Push-In Page 9-27	3311 BSPP/Metric Page 9-27	3312 BSPP/Metric Page 9-27	3313 BSPP Page 9-27	3301 Modular Page 9-28	3302 Simple, double and triple Page 9-28	3303 Plug Page 9-29	3303 Elbow Page 9-29
--	-------------------------------------	---	---	----------------------------------	-------------------------------------	--	----------------------------------	-----------------------------------



Brass Plugs

0205 BSPT Page 9-30	0205 NPT Page 9-30	HHP NPTF Page 9-30	219P NPTF Page 9-30	0209 BSPT Page 9-30	0220 BSPP/Metric Page 9-31	0200 BSPP/Metric Page 9-31	0201 BSPP/Metric Page 9-32	HP3 BSPT Page 9-32	218P NPTF Page 9-32	0202 Metric Page 9-32	0936 BSPT Page 9-33
----------------------------------	---------------------------------	---------------------------------	----------------------------------	----------------------------------	---	---	---	---------------------------------	----------------------------------	------------------------------------	----------------------------------



Nickel-Plated Brass Hollow Hex Plug

0919 BSPP/Metric Page 9-33	0938 BSPP Page 9-33	FN4 BSPP Page 9-33
---	----------------------------------	---------------------------------



Steel Plugs

0206 BSPT Page 9-34	0206 NPT Page 9-34	0210 BSPP/Metric Page 9-34	0216 BSPT Page 9-34	0216 NPT Page 9-35
----------------------------------	---------------------------------	---	----------------------------------	---------------------------------



Stainless Steel Plugs

0285 BSPT Page 9-36	0285 NPT Page 9-36
----------------------------------	---------------------------------



Sealing Accessories

0138 Page 9-37	0137 Page 9-37	0605 Page 9-38	0602 Page 9-38	0139 Page 9-38
--------------------------	--------------------------	--------------------------	--------------------------	--------------------------



Tube Supports

0127 Brass Page 9-39	1827 Stainless steel Page 9-39
-----------------------------------	---



Adaptors, Plugs and Manifolds

Parker Legris offers a **wide range of adaptors and manifolds** compatible with the various Parker Legris fitting systems. This range of products provides the user with a **complete solution** covering numerous applications, both in non-corrosive and corrosive environments.

Product Advantages

Large Range & Flexibility

A complete offer, from the simple adaptor to a modular manifold solution

Large selection of materials for excellent chemical compatibility: brass, steel, stainless steel, aluminium

Surface treatment for increased corrosion resistance: nickel-plated brass or anodised aluminium

Stainless steel for corrosive environments

BSP, BSPP, BSPT, NPT, NPTF and metric threads

Performance

Robust design

Suitable for low to high pressure, depending on configuration and material

Forged shapes for mechanical strength



Applications

- Packaging
- Robotics
- Textile
- Pneumatics
- Automotive Process
- Food Process

Technical Characteristics

Products	Adaptors and Plugs				Manifolds
Component Materials	Brass	Nickel-plated brass	Stainless steel 316L	Steel	Anodised aluminium
Working Pressure	1/8" to 1/2": 200 bar 3/4" and 1": 150 bar 1 1/4" to 2": 100 bar, without sealing washer	60 bar	1/8" to 1/2": 200 bar 3/4" and 1": 150 bar 1 1/4" to 2": 100 bar, without sealing washer	1/8" to 1/2": 200 bar 3/4" and 1": 150 bar 1 1/4" to 2": 100 bar, without sealing washer	20 bar
Working Temperature	-60°C to +150°C without sealing washer -20°C to +100°C with sealing washer	-10°C to +80°C	-20°C to +180°C	-10°C to +80°C	-10°C to +80°C

Thread sealing must be guaranteed by user.

Brass Adaptors

0143 Equal Threaded Elbow, Female BSPP Thread

Brass

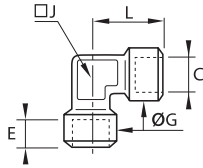

C		E	G	J	L	Kg
G1/8	0143 10 10	7.5	16.5	12	22.5	0.043
G1/4	0143 13 13	11	18.5	15	26.5	0.057
G3/8	0143 17 17	11.5	23.5	19	31.5	0.102
G1/2	0143 21 21	15	28	23	34.5	0.150
G3/4	0143 27 27	16.5	34	27	43.5	0.247

0144 Equal Stud Elbow, Male BSPT/Female BSPP Thread

Brass

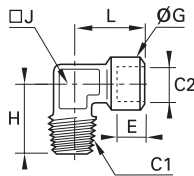

C1	C2		E	G	H	J	L	Kg
R1/8	G1/8	0144 10 10	7.5	16.5	23	12	22.5	0.035
R1/4	G1/4	0144 13 13	11	18.5	26	15	26.5	0.052
R3/8	G3/8	0144 17 17	11.5	23.5	30	19	31.5	0.086
R1/2	G1/2	0144 21 21	15	28	35	23	34.5	0.140
R3/4	G3/4	0144 27 27	16.5	34	40	27	43.5	0.232

0152 Equal Elbow, Male BSPT Thread

Brass

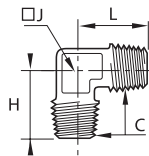

C		H	J	L	Kg
R1/8	0152 10 10	19.5	10	19.5	0.018
R1/4	0152 13 13	25	15	25	0.045
R3/8	0152 17 17	26.5	15	26.5	0.054
R1/2	0152 21 21	31.5	19	31.5	0.088
R3/4	0152 27 27	35.5	23	35.5	0.153

0145 Equal Tee, Female BSPP Thread

Brass

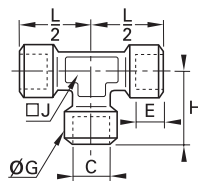

C		E	G	H	J	L/2	Kg
G1/8	0145 10 10	7.5	16.5	22.5	12	22.5	0.057
G1/4	0145 13 13	11	18.5	26.5	15	26.5	0.079
G3/8	0145 17 17	11.5	23.5	31	19	31	0.126
G1/2	0145 21 21	15	28	38	23	38	0.244
G3/4	0145 27 27	16.5	34	47.5	27	47.5	0.370

MR0434 Stud Run Tee, Female BSPP/Male BSPT Thread

Brass

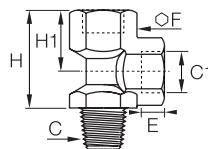

C	C1		E	F	H	H1	H2	Kg
R1/8	G1/8	1/8MR0434B	8	14	32	17	15	0.029
R1/4	G1/4	1/4MR0434B	10	17	40	22	18	0.051
R3/8	G3/8	3/8MR0434B	12	24	49	25	24	0.127
R1/2	G1/2	1/2MR0434B	14	30	63	32	31	0.254

Brass Adaptors

0158

Stud Branch Tee, Male BSPT/Female BSPP Thread

Brass

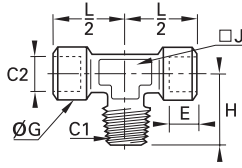

C1	C2		E	G	H	J	L/2	Kg
R1/8	G1/8	0158 10 10	7.5	16.5	21.5	12	21.5	0.046
R1/4	G1/4	0158 13 13	11	18.5	26	15	26	0.075
R3/8	G3/8	0158 17 17	11.5	23.5	30	19	30	0.120
R1/2	G1/2	0158 21 21	15	28	36	23	36	0.204
R3/4	G3/4	0158 27 27	16.5	34	44	27	44	0.310

0117

Equal Bulkhead Coupling, Female BSPP and Metric Thread

Brass

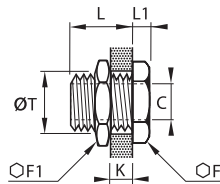

C		F	F1	K _{max}	L	L1	ØT	Kg
M5x0.8	0117 00 19	14	14	7	10.5	3.5	10.5	0.012
G1/8	0117 00 10	19	22	9	14	4	16.5	0.033
G1/4	0117 00 13	24	27	15	21	4	20.5	0.056
G3/8	0117 00 17	30	32	14	21	5	26.5	0.096
G1/2	0117 00 21	32	36	20	27	6	28.5	0.115
G3/4	0117 00 27	41	41	22.5	30	6	34.5	0.161
G1	0117 00 34	46	50	24.5	34	8	42.5	0.266
G1 1/4	0117 00 42	55	55	29.5	39	8	49.5	0.303
G1 1/2	0117 00 49	60	60	29.5	39	8	54.5	0.303

207ACBH

Bulkhead Union, Female NPTF Thread

Brass

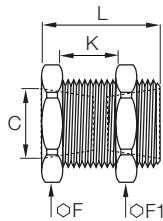

C		F*	F1*	K	L	Kg
NPTF1/8*	207ACBH-2	7/8	15/16	20	38	0.073
NPTF1/4	207ACBH-4	1	1.1/8	18	38	0.101
NPTF3/8	207ACBH-6	1.1/8	1.1/4	13	34	0.127
NPTF1/2	207ACBH-8	1.1/4	1.3/8	16	38	0.158

*Inch dimensions

0155

Equal Connector, Female BSPP Thread

Brass

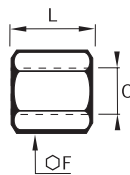

C	C1		F	L	Kg
G1/8	G1/8	0155 10 10	14	17	0.014
G1/4	G1/8	0155 10 13	17	18	0.023
G3/8	G1/8	0155 10 17	22	20	0.045
G1/2	G1/8	0155 10 21	27	22	0.075
G1/4	G1/4	0155 13 13	17	24	0.025
G3/8	G1/4	0155 13 17	22	22	0.046
G1/2	G1/4	0155 13 21	27	24	0.079
G3/8	G3/8	0155 17 17	22	25	0.045
G1/2	G3/8	0155 17 21	17	26	0.048
	G1/2	0155 21 21	27	32	0.084
G3/4	G3/4	0155 27 27	32	35	0.109
G1	G1	0155 34 34	41	36	0.194

Brass Adaptors

GG-B Equal Adaptor, Female NPTF Thread, Heavy Series

Brass

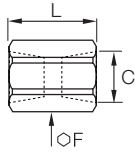

C		F*	L	Kg
NPTF1/8	1/8 GG-B	5/8	19	0.018

*Inch dimensions
Max. working pressure: 260 bar

207P Equal Adaptor, Female NPTF Thread

Brass

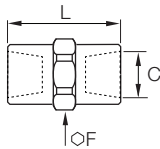

C		F*	L	Kg
NPTF1/8	207P-2	9/16	19	0.017
NPTF1/4	207P-4	3/4	28	0.040
NPTF3/8	207P-6	7/8	28	0.054
NPTF1/2	207P-8	1.1/16	38	0.088

*Inch dimensions

0164 Adaptor, Male NPT/Female BSPP Thread

Brass

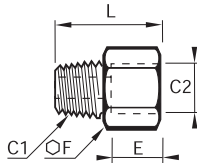

C1	C2		E	F	L	Kg
NPT1/8	G1/8	0164 11 10	7.5	14	20	0.015
NPT1/4	G1/4	0164 14 13	11	17	27.5	0.028
NPT3/8	G3/8	0164 18 17	11.5	22	28.5	0.044
NPT1/2	G1/2	0164 22 21	15	27	36.5	0.082
NPT3/4	G3/4	0164 28 27	16.5	32	38.5	0.110

0167 Adaptor, Male BSPT/Female NPT Thread

Brass

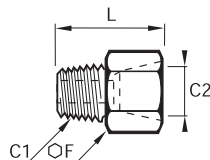

C1	C2		F	L	Kg
R1/8	NPT1/8	0167 10 11	14	21	0.016
R1/4	NPT1/4	0167 13 14	17	28.5	0.029
R3/8	NPT3/8	0167 17 18	22	29.5	0.047
R1/2	NPT1/2	0167 21 22	27	37.5	0.088
R3/4	NPT3/4	0167 27 28	32	39.5	0.120

0168 Reducer, Male BSPP/Female BSPP and Metric Thread

Brass, technical polymer

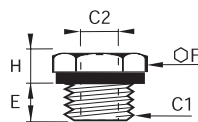

C1	C2		E	F	H	Kg
G1/8	M5x0.8	0168 10 19	7	14	6	0.009
G1/4	M5x0.8	0168 13 19	7	17	7	0.017
	G1/8	0168 13 10	7	17	7	0.011
G3/8	G1/8	0168 17 10	9	19	6	0.019
	G1/4	0168 17 13	9	19	6	0.013
G1/2	G1/8	0168 21 10	11	24	10	0.051
	G1/4	0168 21 13	11	24	10	0.042
	G3/8	0168 21 17	11	24	10	0.030
G3/4	G1/4	0168 27 13	11	32	12	0.098
	G3/8	0168 27 17	11	32	12	0.085
	G1/2	0168 27 21	11	32	12	0.063

With fitted captive seal

Brass Adaptors

0163 Unequal Reducer, Male BSPT/Female BSPP Thread

Brass

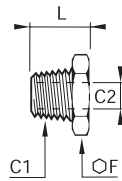

C1	C2		F	L	Kg
R1/4	G1/8	0163 13 10	14	16	0.009
R3/8	G1/8	0163 17 10	17	16.5	0.020
	G1/4	0163 17 13	17	16.5	0.012
R1/2	G1/8	0163 21 10	22	21	0.048
	G3/8	0163 21 17	22	21	0.025
	G1/4	0163 21 13	27	24	0.085
R3/4	G3/8	0163 27 17	27	24	0.069
	G1/2	0163 27 21	27	24	0.046
R1	G1/2	0163 34 21	36	27	0.137
	G3/4	0163 34 27	36	27	0.092

209P Reducer, Male/Female NPTF Thread

Brass

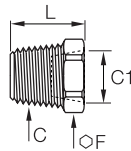

C	C1		F*	L	Kg
NPTF1/4	NPTF1/8	209P-4-2	9/16	19	0.012
NPTF3/8	NPTF1/8	209P-6-2	11/16	18	0.025
	NPTF1/4	209P-6-4	11/16	19	0.179
NPTF1/2	NPTF1/8	209P-8-2	7/8	25	0.049
	NPTF1/4	209P-8-4	7/8	26	0.049
NPTF3/4	NPTF3/8	209P-8-6	7/8	26	0.033
	NPTF1/4	209P-12-4	1.1/8	25	0.080
	NPTF3/8	209P-12-6	1.1/8	26	0.080
	NPTF1/2	209P-12-8	1.1/8	26	0.057

*Inch dimensions

0169 Increaser, Male/Female BSPP Thread

Brass, technical polymer

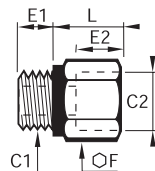

C1	C2		E1	E2	F	L	Kg
G1/8	G1/4	0169 10 13	5	11	17	16	0.019
	G3/8	0169 10 17	5	14	22	19.5	0.038
G1/4	G3/8	0169 13 17	7	14	22	19.5	0.042
	G1/2	0169 13 21	7	14.5	27	20.5	0.061
G3/8	G1/2	0169 17 21	8	14.5	27	20.5	0.062
	G3/4	0169 17 27	8	15.5	32	22	0.082
G1/2	G3/4	0169 21 27	9.5	15.5	32	22.5	0.087

With fitted captive seal

FG43 Reducer, Female BSPP/Male BSPT Thread

Brass

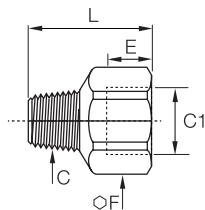

C	C1		E	F	L	Kg
R1/8	G1/4	1/4X1/8FG43B	11	17	21.5	0.020
	G3/8	3/8X1/8FG43B	12	22	25	0.035
R1/4	G1/2	1/2X1/8FG43B	15	27	28	0.063
	G3/8	3/8X1/4FG43B	12	22	28	0.040
R3/8	G1/2	1/2X1/4FG43B	15	27	30	0.071
	G1/2	1/2X3/8FG43B	15	27	29	0.066
R1/2	G3/4	3/4X1/2FG43B	16	32	39	0.113
R3/4	G1	1X3/4FG43B	18	41	38	0.168

Brass Adaptors

222P

Reducer, Female/Male NPTF Thread

Brass

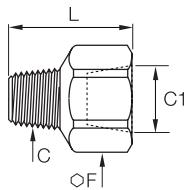

C	C1		F*	L	Kg
NPTF1/8	NPTF1/8	222P-2-2	9/16	22	0.017
	NPTF1/4	222P-4-2	3/4	27	0.021
NPTF1/4	NPTF1/4	222P-4-4	3/4	32	0.039
	NPTF3/8	222P-6-4	7/8	32	0.046
NPTF3/8	NPTF3/8	222P-6-6	7/8	32	0.044
NPTF1/4	NPTF1/2	222P-8-4	1	37	0.076
NPTF3/8	NPTF1/2	222P-8-6	1 1/16	37	0.083

*Inch dimensions

0121

Equal/Unequal Straight Male Adaptor, Male BSPT Thread

Brass

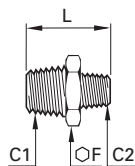

C1	C2		F	L	Kg
R1/8	R1/8	0121 10 10	11	19	0.009
R1/4	R1/8	0121 13 10	14	23.5	0.017
	R1/4	0121 13 13	14	27	0.020
R3/8	R1/8	0121 17 10	17	24	0.022
	R3/8	0121 17 13	17	27.5	0.025
R1/2	R1/4	0121 21 10	22	28.5	0.043
	R3/8	0121 21 13	22	32	0.045
R3/4	R1/2	0121 21 21	22	36	0.053
	R3/4	0121 27 13	27	35	0.077
R1	R3/8	0121 27 17	27	35.5	0.077
	R1	0121 27 21	27	39	0.083
R1 1/4	R3/4	0121 27 27	27	40	0.090
	R1	0121 34 17	36	38.5	0.127
R1 1/2	R1/2	0121 34 21	36	42	0.136
	R3/4	0121 34 27	36	43	0.143
R1 3/4	R1	0121 34 34	36	46	0.152
	R1 1/2	0121 42 21	46	46.5	0.217
R2	R3/4	0121 42 27	46	47.5	0.229
	R2	0121 42 34	46	50.5	0.239
R2 1/2	R2 1/4	0121 42 42	46	53	0.230

FF44

Equal Adaptor, Male BSPP Thread

Brass

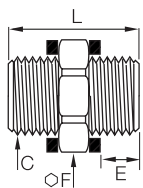

C		E	F	L	Kg
G1/8	1/8FF44B	6	14	19	0.018
G1/4	1/4FF44B	7	17	22	0.022
G3/8	3/8FF44B	8	22	24	0.040
G1/2	1/2FF44B	10	27	31	0.077

These parts are supplied with two copper seals.

0121

Equal Adaptor, Male NPT/BSPT Thread

Brass

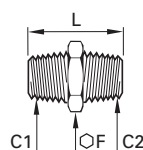

C1	C2		F	L	Kg
NPT1/8	R1/8	0121 11 10	11	19	0.009
NPT1/4	R1/4	0121 14 13	14	27	0.020
NPT3/8	R3/8	0121 18 17	17	28	0.026
NPT1/2	R1/2	0121 22 21	22	36	0.052
NPT3/4	R3/4	0121 28 27	27	40	0.090

Brass Adaptors

216P

Equal Adaptor, Male NPTF Thread

Brass

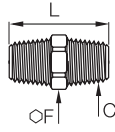

C	C1		F*	L	Kg
NPTF1/8	NPTF1/8	216P-2	7/16	25	0.008
NPTF3/8	NPTF1/8	216P-6-2	11/16	31	0.028
NPTF1/4	NPTF1/4	216P-4	9/16	35	0.025
	NPTF1/8	216P-4-2	9/16	30	0.001
NPTF3/8	NPTF3/8	216P-6	11/16	36	0.029
	NPTF1/4	216P-6-4	11/16	36	0.033
NPTF1/2	NPTF1/4	216P-8-4	7/8	41	0.057
	NPTF1/2	216P-8	7/8	46	0.064
	NPTF3/8	216P-8-6	7/8	41	0.056

*Inch dimensions

0929

Equal 3-Piece Adaptor, Male BSPT Thread

Brass, NBR

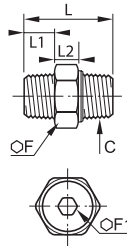

C		F	F1	L	L1	L2	Kg
R1/8	0929 01 10	15	5	27	7.5	8.5	0.017
R1/4	0929 01 13	19	6	33.5	11	9.5	0.035
R3/8	0929 01 17	22	8	36.5	11.5	10	0.055
R1/2	0929 01 21	27	12	45	14	12	0.089
R3/4	0929 01 27	36	14	52.5	16.5	17	0.261
R1	0929 01 34	46	19	63.5	19	20	0.600

This connection accessory makes assembly much easier thanks to its 3-piece design.

To join 2 threaded components, simply push together and tighten the sleeve nut, thus reducing installation time.

Maximum working pressure: 50 bar

Working temperature: -10° to +80°C

Supplied with seal

0123

Tailpiece Adaptor for Rubber Hose, Male BSPT Thread

Brass

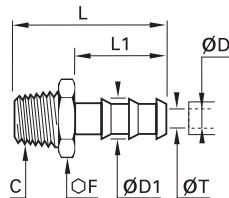

ØD	ØD1	C		F	L	L1	ØT	Kg
4	6	R1/8	0123 04 10	10	34	22.5	3.3	0.008
6	8	R1/8	0123 06 10	10	34	22.5	5	0.009
		R1/8	0123 07 10	10	34	22.5	5	0.009
7	9	R1/4	0123 07 13	14	38.5	22.5	6	0.018
		R3/8	0123 07 17	17	39	22.5	6	0.024
		R1/8	0123 10 10	13	34	22.5	5	0.014
10	12.2	R1/4	0123 10 13	14	38.5	22.5	7	0.020
		R3/8	0123 10 17	17	39	22.5	9.5	0.023
12	14	R3/8	0123 12 17	17	46	29.5	11	0.026
		R1/4	0123 13 13	17	45.5	29.5	7	0.026
13	15	R3/8	0123 13 17	17	46	29.5	11	0.027
		R1/2	0123 13 21	22	50.5	29.5	12	0.045
		R3/8	0123 16 17	19	54.5	38	11	0.038
16	18.5	R1/2	0123 16 21	22	59	38	14	0.054
		R3/4	0123 16 27	27	62	38	15	0.084
		R3/8	0123 19 17	22	54.5	38	11	0.047
19	21.5	R1/2	0123 19 21	22	59	38	14	0.057
		R3/4	0123 19 27	27	62	38	18	0.082
25	26.7	R3/4	0123 25 27	27	62	38	18	0.078
	27	R1	0123 25 34	36	65	38	24	0.126
32	34.5	R1	0123 32 34	36	70	43	24	0.142

Brass Adaptors

0136

Tailpiece Adaptor for Flexible Tubing, Male BSPT Thread

Brass

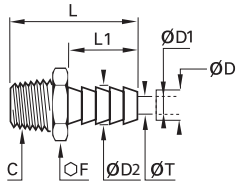

ØD	ØD1	ØD2	C		F	L	L1	ØT	Kg
6	4	4.3	R1/8	0136 06 10	10	26.5	15	2	0.007
		4.3	R1/4	0136 06 13	14	31	15	2	0.015
		4.3	R3/8	0136 06 17	17	31.5	15	2	0.019
8	6	6.4	R1/8	0136 08 10	10	26.5	15	4	0.007
		6.4	R1/4	0136 08 13	14	31	15	4	0.015
		6.4	R3/8	0136 08 17	17	31.5	15	4	0.020
10	8	8.4	R1/4	0136 10 13	14	31	15	6	0.016
		8.4	R3/8	0136 10 17	17	31.5	15	6	0.020
		8.4	R1/2	0136 10 21	22	36	15	6	0.039
12	10	10.7	R1/4	0136 12 13	14	36	20	7	0.018
		10.7	R3/8	0136 12 17	17	36.5	20	8	0.023
		10.7	R1/2	0136 12 21	22	41	20	8	0.040
14	12	12.7	R1/4	0136 14 13	14	36	20	7	0.019
		12.7	R3/8	0136 14 17	17	36.5	20	10	0.023
		12.7	R1/2	0136 14 21	22	41	20	10	0.040
16	13	12.7	R3/4	0136 14 27	27	44	20	10	0.071
		13.7	R3/8	0136 16 17	17	36.5	20	11	0.023
		13.7	R1/2	0136 16 21	22	41	20	11	0.040
					27	44	20	11	0.071

Nickel-Plated Brass Adaptors

0912 Equal Stud Elbow, Female BSPP and Metric Thread

Nickel-plated brass

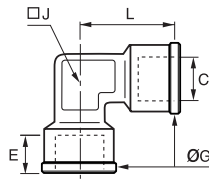

C		E	G	J	L	Kg
M5x0.8	0912 00 19	4	8	9	11	0.006
G1/8	0912 00 10	8	13	10	18.5	0.015
G1/4	0912 00 13	11.5	17	12	22.5	0.028
G3/8	0912 00 17	11.5	21	15	25.5	0.043
G1/2	0912 00 21	14	26	19	30	0.074
G3/4	0912 00 27	16.5	32	22	35.5	0.101
G1	0912 00 34	18	38.5	28	40.5	0.168

DD44BKTL

90° Bracketed Equal Elbow, Female BSPP Thread

Nickel-plated brass

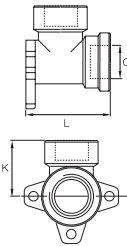

C		K	L	Kg
G1/2	1/2DD44BKTL	27	40.5	0.061

0921

Equal Stud Elbow, Male/Female and Metric Thread

Nickel-plated brass

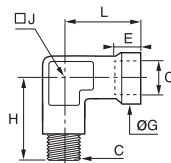

C		E	G	H	J	L	Kg
M5x0.8	0921 00 19	4	8	11.5	9	11	0.007

0913

Equal Stud Elbow, Male BSPT/ Female BSPP Thread

Nickel-plated brass

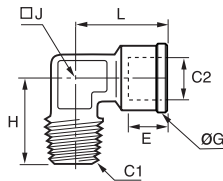

C1	C2		E	G	H	J	L	Kg
R1/8	G1/8	0913 00 10	8	13	17	10	18.5	0.013
R1/4	G1/4	0913 00 13	11.5	17	22.5	12	22.5	0.025
R3/8	G3/8	0913 00 17	11.5	21	25.5	15	25.5	0.039
R1/2	G1/2	0913 00 21	14	26	30	19	30	0.062
R3/4	G3/4	0913 00 27	16.5	32	34.5	22	35.5	0.100
R1	G1	0913 00 34	18	38.5	40.5	28	40.5	0.167

0922

Equal Stud Elbow, Male Metric Thread

Nickel-plated brass

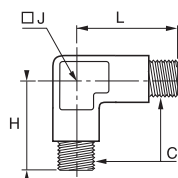

C		H	J	L	Kg
M5x0.8	0922 00 19	11.5	9	11.5	0.010

Nickel-Plated Brass Adaptors

0914 Equal Stud Elbow, Male BSPT Thread

Nickel-plated brass

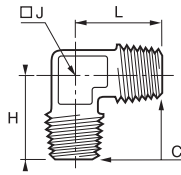

C		H	J	L	Kg
R1/8	0914 00 10	17	10	17	0.010
R1/4	0914 00 13	22.5	12	22.5	0.022
R3/8	0914 00 17	25.5	15	25.5	0.034
R1/2	0914 00 21	30	19	30	0.059
R3/4	0914 00 27	34.5	22	34.5	0.104
R1	0914 00 34	40.5	28	40.5	0.156

0910 Equal Y, Female BSPP Thread

Nickel-plated brass

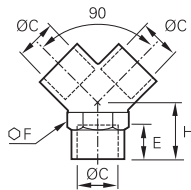

C		E	F	H	Kg
G1/8	0910 00 10	8	13	12	0.018
G1/4	0910 00 13	11	17	14	0.034
G3/8	0910 00 17	11.5	20	16	0.045
G1/2	0910 00 21	14	25	19	0.086

0911 Equal Y, Male BSPT/Female BSPP Thread

Nickel-plated brass

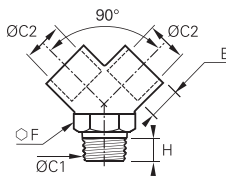

C1	C2		E	F	H	Kg
R1/8	G1/8	0911 00 10	8	13	8	0.022
R1/4	G1/4	0911 00 13	11	17	11	0.039
R3/8	G3/8	0911 00 17	11.5	20	11.5	0.051
R1/2	G1/2	0911 00 21	14	25	14	0.105

0915 Equal Tee, Female BSPP and Metric Thread

Nickel-plated brass

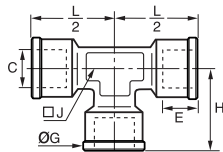

C		E	G	H	J	L/2	Kg
M5x0.8	0915 00 19	5	8	11	9	11	0.010
G1/8	0915 00 10	8	13	18.5	10	18.5	0.022
G1/4	0915 00 13	11	17	22.5	12	22.5	0.042
G3/8	0915 00 17	11.5	21	25.5	15	25.5	0.062
G1/2	0915 00 21	14	26	30	19	30	0.099
G3/4	0915 00 27	16.5	32	35.5	22	35.5	0.145
G1	0915 00 34	18	38.5	40.5	28	40.5	0.233

0923 Equal Stud Branch Tee, Female/Male Metric Thread

Nickel-plated brass

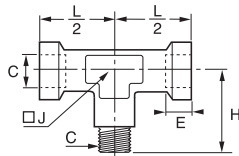

C		E	G	H	J	L/2	Kg
M5x0.8	0923 00 19	4	8	11.5	9	11	0.009

Nickel-Plated Brass Adaptors

0916 Equal Stud Branch Tee, Male BSPT/Female BSPP Thread

Nickel-plated brass

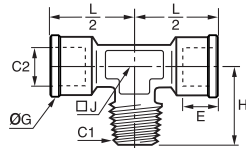

C1	C2		E	G	H	J	L/2	Kg
R1/8	G1/8	0916 00 10	8	13	17	10	18	0.019
R1/4	G1/4	0916 00 13	11	17	22.5	12	22.5	0.038
R3/8	G3/8	0916 00 17	11.5	21	25.5	15	25.5	0.059
R1/2	G1/2	0916 00 21	14	26	30	19	30	0.091
R3/4	G3/4	0916 00 27	16.5	32	34.5	22	35	0.139
R1	G1	0916 00 34	18	38.5	40.5	28	40.5	0.237

0924 Equal Stud Run Tee, Female/Male Metric Thread

Nickel-plated brass

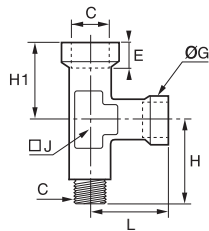

C		E	G	H	H1	J	L	Kg
M5x0.8	0924 00 19	4	8	12	11	9	11	0.009

0917 Equal Stud Run Tee, Female BSPP/Male BSPT Thread

Nickel-plated brass

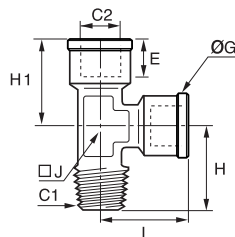

C1	C2		E	G	H	H1	J	L	Kg
R1/8	G1/8	0917 00 10	8	13	17	18.5	10	18.5	0.018
R1/4	G1/4	0917 00 13	11	17	22.5	22.5	12	22.5	0.038
R3/8	G3/8	0917 00 17	11.5	21	25.5	25.5	15	25.5	0.057
R1/2	G1/2	0917 00 21	14	26	30	30	19	30	0.090
R3/4	G3/4	0917 00 27	16.5	32	34.5	35.5	22	35.5	0.137
R1	G1	0917 00 34	18	38.5	40.5	40.5	28	40.5	0.219

0927 Equal Tee, Male BSPT Thread

Nickel-plated brass

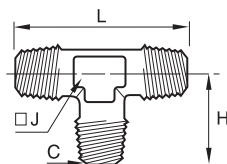

C		H	J	L	Kg
R1/8	0927 00 10	17	10	34	0.013
R1/4	0927 00 13	22.5	12	45	0.032
R3/8	0927 00 17	25.5	15	51	0.056
R1/2	0927 00 21	30	19	60	0.094
R3/4	0927 00 27	34.5	22	69	0.133
R1	0927 00 34	40.5	28	81	0.217

0928 Equal Stud Branch Tee, Male BSPT/ Female BSPP Thread

Nickel-plated brass

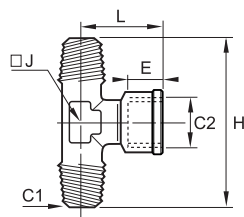

C1	C2		E	H	J	L	Kg
R1/8	G1/8	0928 00 10	8	34	10	18.5	0.016
R1/4	G1/4	0928 00 13	11	45	12	22.5	0.035
R3/8	G3/8	0928 00 17	11.5	51	15	25.5	0.053
R1/2	G1/2	0928 00 21	14	60	19	30	0.087
R3/4	G3/4	0928 00 27	16.5	69	22	35.5	0.236
R1	G1	0928 00 34	18	81	28	40.5	0.225

Nickel-Plated Brass Adaptors

0932 Equal Stud Run Tee, Male BSPT/Female BSPP Thread

Nickel-plated brass

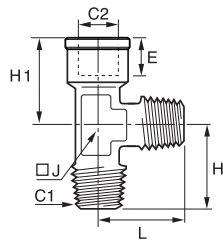

C1	C2		E	H	H1	J	L	Kg
R1/8	G1/8	0932 00 10	8	17	18.5	10	17	0.016
R1/4	G1/4	0932 00 13	11	22.5	22.5	12	22.5	0.035
R3/8	G3/8	0932 00 17	11.5	25.5	25.5	15	25.5	0.055
R1/2	G1/2	0932 00 21	14	30	30	19	30	0.091
R3/4	G3/4	0932 00 27	16.5	34.5	35.5	22	34.5	0.080
R1	G1	0932 00 34	18	40.5	40.5	28	40.5	0.226

0908 Equal Cross, Female BSPP Thread

Nickel-plated brass

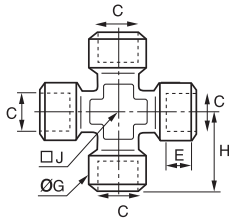

C		E	G	H	J	Kg
G1/8	0908 00 10	8	13	21	10	0.038
G1/4	0908 00 13	11	17	25.5	13	0.075
G3/8	0908 00 17	11.5	21	28	17	0.108
G1/2	0908 00 21	14	26	33.5	21	0.184

0909 Equal Cross, Male BSPT/Female BSPP Thread

Nickel-plated brass

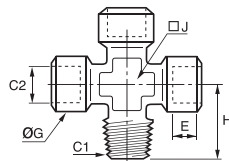

C1	C2		E	G	H	J	Kg
R1/8	G1/8	0909 00 10	8	13	18.5	10	0.034
R1/4	G1/4	0909 00 13	11	17	23.5	13	0.069
R3/8	G3/8	0909 00 17	11.5	21	26	17	0.098
R1/2	G1/2	0909 00 21	14	26	31	21	0.167

KRRS3 Equal Cross, Male BSPT Thread

Nickel-plated brass

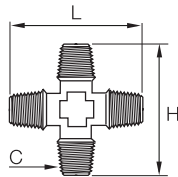

C		H	L	Kg
R1/4	1/4KRRS3BL	47	47	0.046

0903 Reducer, Male/Female BSPP Thread

Nickel-plated brass

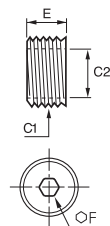

C1	C2		E	F	Kg
G1/4	G1/8	0903 10 13	8	6	0.004
G3/8	G1/4	0903 13 17	9	8	0.007
G1/2	G3/8	0903 17 21	10	10	0.011
G3/4	G1/2	0903 21 27	14	12	0.022
G1	G3/4	0903 27 34	20	17	0.037

Nickel-Plated Brass Adaptors

0904 Reducer, Male BSPT/Female BSPP Thread

Nickel-plated brass

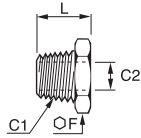

C1	C2		F	L	Kg
R1/4	G1/8	0904 10 13	14	16	0.010
R3/8	G1/8	0904 10 17	17	16.5	0.021
R1/2	G1/8	0904 10 21	22	19.5	0.046
R3/8	G1/4	0904 13 17	17	16.5	0.015
	G1/4	0904 13 21	22	19.5	0.033
R1/2	G3/8	0904 17 21	22	19.5	0.024
	G3/8	0904 17 27	27	23	0.057
R3/4	G1/2	0904 21 27	27	23	0.045
	G1/2	0904 21 34	34	27	0.103
R1	G3/4	0904 27 34	34	27	0.770

0905 Reducer, Male BSPP/Female BSPP and Metric Thread

Nickel-plated brass

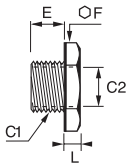

C1	C2		E	F	L	Kg
G1/8	M5x0.8	0905 19 10*	6	14	4.5	0.008
G1/4	G1/8	0905 10 13*	8	17	5	0.011
G3/8	G1/8	0905 10 17*	9	19	5	0.019
G1/2	G1/8	0905 10 21	10	24	5.5	0.034
G3/8	G1/4	0905 13 17	9	19	5	0.013
	G1/4	0905 13 21	10	24	5.5	0.032
G1/2	G3/8	0905 17 21	10	24	5.5	0.021
	G3/8	0905 17 27	11	30	6.5	0.054
G3/4	G1/2	0905 21 27*	11	30	6.5	0.040

*Please contact us for detailed drawings of external thread.

0906 Increaser, Male BSPP and Metric/Female BSPP Thread

Nickel-plated brass

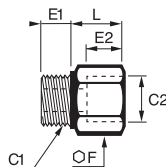

C1	C2		E1	E2	F	L	Kg
M5x0.8	G1/8	0906 10 19	4	8	14	10.5	0.010
	G1/8	0906 00 10	6	8	14	10.5	0.011
G1/8	G1/4	0906 10 13	6	11	17	13.5	0.017
	G3/8	0906 10 17	6	11.5	22	14.5	0.030
	G1/4	0906 00 13	8	11	17	13.5	0.019
G1/4	G3/8	0906 13 17	8	11.5	22	14.5	0.032
	G1/2	0906 13 21	8	14	24	18	0.037
G3/8	G3/8	0906 00 17	9	11.5	22	14.5	0.034
	G1/2	0906 17 21	9	14	24	18	0.038
G1/2	G1/2	0906 00 21	10	14	26	20	0.053

0933 Increaser, Male BSPT/Female BSPP Thread

Nickel-plated brass

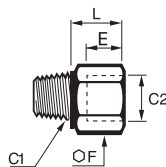



C1	C2		F	L	Kg
R1/8	G1/8	0933 00 10	14	10	0.011
R1/4	G1/4	0933 00 13	17	13.5	0.021
R3/8	G3/8	0933 00 17	22	14.5	0.037
R1/2	G1/2	0933 00 21	26	18	0.059
	G1/4	0933 10 13	17	13.5	0.018
R1/8	G3/8	0933 10 17	22	14.5	0.029
	G3/8	0933 13 17	22	14.5	0.034
R1/4	G1/2	0933 13 21	24	18	0.045
	G1/2	0933 17 21	24	18	0.030
R1/2	G3/4	0933 21 27	32	23.5	0.080

Nickel-Plated Brass Adaptors

0907 Equal Extended Adaptor, Male/Female BSPP Thread

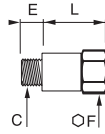
Nickel-plated brass



C		E	F	L	Kg
G1/8	0907 00 10	6	14	16	0.015
	0907 00 10 01	6	14	36	0.030
G1/4	0907 00 13	8	17	27	0.032
	0907 00 13 01	8	17	43	0.047

0920 Bulkhead Connector, Female BSPP and Metric Thread

Nickel-plated brass

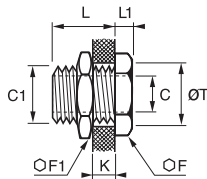

C	C1		F	F1	K _{max}	L	L1	ØT	Kg
M5x0.8	M10x1	0920 00 19	14	14	7	10.5	3.5	10.5	0.012
G1/8	M16x1.5	0920 00 10	19	22	10	14	4	16.5	0.029
G1/4	M20x1.5	0920 00 13	24	27	16	21	4	20.5	0.056
G3/8	M26x1.5	0920 00 17	30	32	15	21	5	26.5	0.094
G1/2	M28x1.5	0920 00 21	32	36	21	27	6	28.5	0.115

0900 Equal and Unequal Adaptor, Male BSPT Thread

Nickel-plated brass

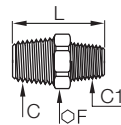

C1	C2		F	L	Kg
R1/8	R1/8	0900 00 10	12	20.5	0.009
	R1/4	0900 10 13	14	24	0.015
	R3/8	0900 10 17	17	24.5	0.020
R1/4	R1/4	0900 00 13	14	27	0.019
	R3/8	0900 13 17	17	27.5	0.025
R3/8	R1/2	0900 13 21	22	30.5	0.045
	R3/8	0900 00 17	17	28	0.025
R1/2	R1/2	0900 17 21	22	31	0.045
	R3/4	0900 00 21	22	33.5	0.044
R3/4	R3/4	0900 21 27	27	37	0.083
	R1	0900 00 27	27	39.5	0.079
R1	R1	0900 27 34	34	42.5	0.143
	R1	0900 00 34	34	45.5	0.152

0901 Equal and Unequal Adaptor, Male BSPP and Metric Thread

Nickel-plated brass

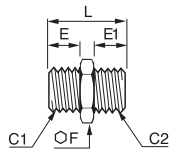

C1	C2		E	E1	F	L	Kg
M5x0.8	M5x0.8	0901 00 19	4	4	8	11.5	0.002
	G1/8	0901 19 10	4	6	14	14.5	0.008
G1/8	G1/8	0901 00 10	6	6	14	16.5	0.009
	G1/4	0901 10 13	6	8	17	19	0.016
	G3/8	0901 10 17	6	9	19	20	0.020
G1/4	G1/4	0901 00 13	8	8	17	21	0.019
	G3/8	0901 13 17	8	9	19	22	0.023
G3/8	G1/2	0901 13 21	8	10	24	23.5	0.036
	G3/8	0901 00 17	9	9	19	23	0.025
G1/2	G1/2	0901 17 21	9	10	24	24.5	0.038
	G1/2	0901 00 21	10	10	24	25.5	0.039
G1/2	G3/4	0901 21 27	10	12	30	27.5	0.062

Nickel-Plated Brass Adaptors

0192 Unequal Straight Adaptor, Male BSPT/BSPP Thread

Nickel-plated brass

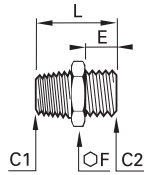

C1	C2		E	F	L	Kg
R1/8	G1/4	0192 10 13	9.5	17	23.5	0.019
R1/4	G1/4	0192 13 13	9.5	17	27.5	0.024
	G1/2	0192 13 21	11	27	31.5	0.068
R3/8	G1/4	0192 17 13	9.5	17	28	0.025
	G1/2	0192 17 21	11	27	31.5	0.060
R1/2	G1/2	0192 21 21	11	27	34	0.061

0902 Equal and Unequal Adaptor, Female BSPP and Metric Thread

Nickel-plated brass

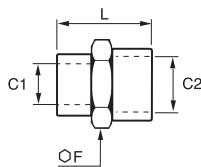

C1	C2		F	L	Kg
M5x0.8	M5x0.8	0902 00 19	8	11	0.003
	G1/8	0902 19 10	14	13.5	0.009
G1/8	G1/8	0902 00 10	14	15	0.010
	G1/4	0902 10 13	17	19	0.017
	G3/8	0902 10 17	22	20	0.027
G1/4	G1/2	0902 10 21	24	20	0.015
	G1/4	0902 00 13	17	22	0.020
	G3/8	0902 13 17	22	22.5	0.030
G3/8	G1/2	0902 13 21	26	24	0.033
	G3/8	0902 00 17	22	23	0.033
	G1/2	0902 17 21	24	26	0.036
G1/2	G1/2	0902 00 21	26	28	0.048
	G3/4	0902 21 27	32	30	0.077
	G1	0902 21 34	40	39	0.145
G3/4	G3/4	0902 00 27	32	32	0.076
	G1	0902 27 34	40	41	0.146

0191 Tailpiece Adaptor for Rubber Hose, Male BSPP Thread

Nickel-plated brass

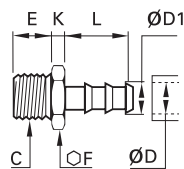

ØD	ØD1	C		E	F	K	L	Kg
4	6	G1/4	0191 04 13	9.5	17	5	22.5	0.019
		G1/4	0191 07 13	9.5	17	5	22.5	0.022
7	9	G1/2	0191 07 21	11	27	7	29.5	0.056
		G1/4	0191 10 13	9.5	17	5	22.5	0.020
10	12.2	G1/2	0191 10 21	11	27	7	29.5	0.060
		G1/4	0191 13 13	9.5	17	5	22.5	0.022
13	15.2	G1/2	0191 13 21	11	27	7	29.5	0.059
		G1/2	0191 16 21	11	27	7	36.5	0.068

0931 Tailpiece Adaptor for Rubber Hose, Male BSPP Thread

Nickel-plated brass

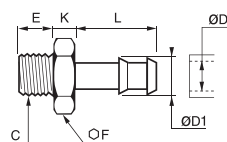

ØD	ØD1	C		E	F	K	L	Kg
4	4.5	M5x0.8	0931 04 19	4	8	4	15	0.003
		G1/8	0931 06 10	6	12	4.5	19	0.009
6	7	G1/4	0931 06 13	8	14	5	19	0.013
		G1/8	0931 07 10	6	12	4	19	0.009
7	8	G1/4	0931 07 13	8	14	5	19	0.013
		G3/8	0931 07 17	9	19	5	19	0.022
		G1/8	0931 08 10	6	12	4	19	0.009
8	9	G1/4	0931 08 13	8	14	5	19	0.014
		G3/8	0931 08 17	9	19	5	19	0.022
10	12	G1/4	0931 10 13	8	14	5	19	0.016
		G3/8	0931 10 17	9	19	5	19	0.023
15	17	G1/2	0931 10 21	10	22	6	20	0.031
		G3/8	0931 15 17	9	19	6	24	0.030
18	20	G1/2	0931 15 21	10	22	6	24	0.038
		G1/2	0931 18 21	10	22	6	24	0.040

Nickel-Plated Brass Adaptors

0934

Tailpiece Adaptor for Polymer Tubing, Male BSPT Thread

Nickel-plated brass

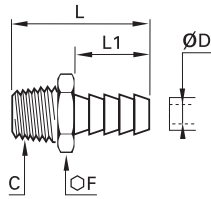

ØD	C		F	L	L1	Kg
6	R1/8	0934 06 10	12	31.5	19	0.009
	R1/4	0934 06 13	14	35	19	0.014
7	R1/8	0934 07 10	12	31.5	19	0.009
	R1/4	0934 07 13	14	35	19	0.014
8	R1/8	0934 08 10	12	31.5	19	0.010
	R1/4	0934 08 13	14	35	19	0.015
9	R1/8	0934 09 10	12	31.5	19	0.012
	R1/4	0934 09 13	14	35	19	0.015
	R3/8	0934 09 17	17	35.5	19	0.021
10	R1/2	0934 09 21	22	38.5	19	0.032
	R1/8	0934 10 10	12	32.5	20	0.010
	R1/4	0934 10 13	14	36	20	0.015
12	R3/8	0934 10 17	17	36.5	20	0.022
	R1/2	0934 10 21	22	39.5	20	0.033
	R1/4	0934 12 13	14	36	20	0.019
14	R3/8	0934 12 17	17	36.5	20	0.021
	R1/2	0934 12 21	22	39.5	20	0.033
16	R3/8	0934 14 17	17	38.5	22	0.023
	R1/2	0934 14 21	22	41.5	22	0.036
17	R3/8	0934 16 17	17	38.5	22	0.026
	R1/2	0934 16 21	22	41.5	22	0.038
18	R3/4	0934 16 27	27	45	22	0.062
	R3/8	0934 17 17	18	40.5	24	0.030
20	R1/2	0934 17 21	22	43.5	24	0.043
	R3/8	0934 18 17	19	40.5	24	0.031
18	R1/2	0934 18 21	22	43.5	24	0.043
	R3/4	0934 18 27	27	47	24	0.062
20	R3/8	0934 20 17	22	41	24	0.038
	R1/2	0934 20 21	22	43.5	24	0.046

0935

Tailpiece Adaptor for Polymer Tubing, Male BSPP Thread

Nickel-plated brass

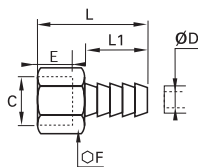

ØD	C		E	F	L	L1	Kg
6	G1/8	0935 06 10	8	12	28.5	19	0.007
7	G1/8	0935 07 10	8	12	28.5	19	0.012
8	G1/4	0935 08 13	11	15	31.5	19	0.019
9	G1/4	0935 09 13	11	15	31.5	19	0.020
	G3/8	0935 09 17	11.5	19	32	19	0.025
10	G3/8	0935 10 17	11.5	19	33	20	0.025
12	G3/8	0935 12 17	11.5	19	33	20	0.027
	G1/2	0935 12 21	14.5	24	36	20	0.040

Stainless Steel Adaptors

1844 Equal Stud Elbow, Male BSPT/Female BSPP Thread

Stainless steel 316L

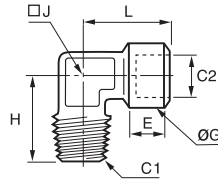

C1	C2		E	G	H	J	L	Kg
R1/8	G1/8	1844 10 10	7.5	15	20.5	10	22.5	0.022
R1/4	G1/4	1844 13 13	12	18.5	27.5	12	26.5	0.047
R3/8	G3/8	1844 17 17	12	23.5	28	14	30	0.069
R1/2	G1/2	1844 21 21	15	28	38	18	38	0.116
R3/4	G3/4	1844 27 27	16.5	33	41	22	44.5	0.158
R1	G1	1844 34 34	19	40	48	32	50	0.312

1843 Equal Elbow, Female BSPP Thread

Stainless steel 316L

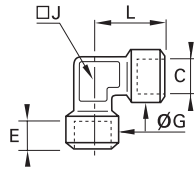

C		E	G	J	L	Kg
G1/8	1843 10 10	7.5	17.5	12	22.5	0.042
G1/4	1843 13 13	11	18.5	15	26.5	0.053
G3/8	1843 17 17	11.5	23.5	18	29	0.079
G1/2	1843 21 21	15	28	23	38	0.157
G3/4	1843 27 27	16.5	33	22	43.5	0.209
G1	1843 34 34	19	40	32	52	0.444

1845 Equal Tee, Female BSPP Thread

Stainless steel 316L

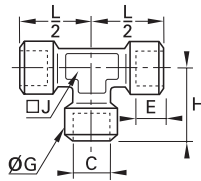

C		E	G	H	J	L/2	Kg
G1/8	1845 10 10	7.5	17.5	22.5	12	22.5	0.058
G1/4	1845 13 13	11	18.5	26.5	15	26.5	0.076
G3/8	1845 17 17	11.5	23.5	29	18	29	0.102
G1/2	1845 21 21	15	28	38	23	38	0.218
G3/4	1845 27 27	16.5	33	43.5	22	43.5	0.301
G1	1845 34 34	19	40	50	32	50	0.446

1817 Equal Bulkhead Adaptor, Female BSPP Thread

Stainless steel 316L

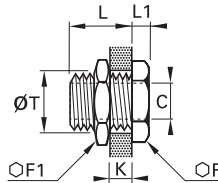

C		F	F1	K max	L	L1	ØT min	Kg
G1/8	1817 00 10	19	22	9	14	4	16.5	0.031
G1/4	1817 00 13	24	27	15	21	4	20.5	0.053
G3/8	1817 00 17	30	32	14	21	5	26.5	0.090
G1/2	1817 00 21	32	36	20	27	6	28.5	0.108
G3/4	1817 00 27	41	41	22.5	30	6	34.5	0.152
G1	1817 00 34	46	50	24.5	34	8	42.5	0.251

1871 Equal Bulkhead Adaptor, Female NPT Thread

Stainless steel 316L

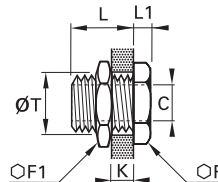

C		F	F1	K max	L	L1	ØT min	Kg
NPT1/8	1871 00 11	19	22	9	14	5	16.5	0.031
NPT1/4	1871 00 14	24	22	9	14	5	16.5	0.060
NPT3/8	1871 00 18	30	32	18	23	5	26.5	0.096
NPT1/2	1871 00 22	32	36	22	29	6	28.5	0.119

Stainless Steel Adaptors

1855 Equal Connector, Female BSPP Thread

Stainless steel 316L

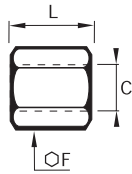

C		F	L	Kg
G1/8	1855 10 10	14	17	0.013
G1/4	1855 13 13	17	24	0.023
G3/8	1855 17 17	22	25	0.042
G1/2	1855 21 21	27	32	0.079
G3/4	1855 27 27	14	35	0.102
G1	1855 34 34	41	40	0.202

1870 Equal Connector, Female NPT Thread

Stainless steel 316L

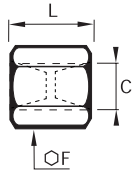

C		F	L	Kg
NPT1/8	1870 11 11	14	19	0.015
NPT1/4	1870 14 14	17	28	0.029
NPT3/8	1870 18 18	22	28	0.050
NPT1/2	1870 22 22	27	35	0.092

1862 Reducer Connector, Female BSPP Thread

Stainless steel 316L

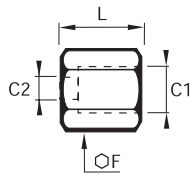

C1	C2		F	L	Kg
G1/4	G1/8	1862 13 10	17	20.5	0.024
G3/8	G1/8	1862 17 10	22	21	0.043
	G1/4	1862 17 13	22	24.5	0.048
G1/2	G1/4	1862 21 13	27	28.5	0.086
	G3/8	1862 21 17	27	29	0.081
G3/4	G1/2	1862 27 21	32	39.5	0.148
G1	G3/4	1862 34 27	41	45	0.281

1864 Adaptor, Male NPT/Female BSPP Thread

Stainless steel 316L

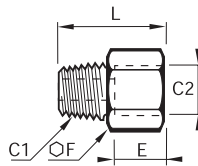

C1	C2		E	F	L	Kg
NPT1/8	G1/8	1864 11 10	7.5	14	21.5	0.015
NPT1/4	G1/4	1864 14 13	11	17	30	0.028
NPT3/8	G3/8	1864 18 17	11.5	22	31	0.043
NPT1/2	G1/2	1864 22 21	15	27	39.5	0.081

1867 Adaptor, Male BSPT/Female NPT Thread

Stainless steel 316L

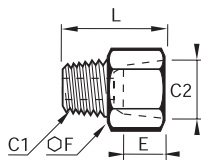

C1	C2		E	F	L	Kg
R1/8	NPT1/8	1867 10 11	8	14	21	0.015
R1/4	NPT1/4	1867 13 14	11.5	17	28.5	0.028
R3/8	NPT3/8	1867 17 18	12	22	29.5	0.044
R1/2	NPT1/2	1867 21 22	15.5	27	37.5	0.083

Stainless Steel Adaptors

1863 Reducer, Male BSPT/Female BSPP Thread

Stainless steel 316L

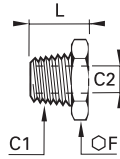

C1	C2		F	L	Kg
R1/4	G1/8	1863 13 10	14	16	0.008
R3/8	G1/8	1863 17 10	17	16.5	0.019
	G1/4	1863 17 13	17	16.5	0.011
R1/2	G1/4	1863 21 13	22	21	0.035
	G3/8	1863 21 17	22	21	0.023
R3/4	G1/2	1863 27 21	27	25.5	0.045
R1	G3/4	1863 34 27	36	28.5	0.083

1872 Reducer, Male/Female NPT Thread

Stainless steel 316L

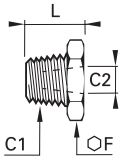

C1	C2		F	L	Kg
NPT1/4	NPT1/8	1872 14 11	14	16	0.010
NPT3/8	NPT1/8	1872 18 11	19	16.5	0.023
	NPT1/4	1872 18 14	19	16.5	0.016
NPT1/2	NPT1/4	1872 22 14	22	21	0.039
	NPT3/8	1872 22 18	22	21	0.027

1861 Increaser, Male BSPT/Female BSPP Thread

Stainless steel 316L

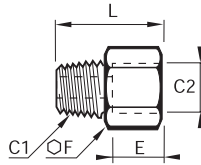

C1	C2		E	F	L	Kg
R1/8	G1/4	1861 10 13	11	17	24	0.022
	G3/8	1861 10 17	11.5	22	25	0.038
R1/4	G3/8	1861 13 17	11.5	22	28.5	0.042
	G1/2	1861 13 21	15	27	32.5	0.069
R3/8	G1/2	1861 17 21	15	27	33	0.070
R1/2	G3/4	1861 21 27	16.5	32	38	0.093
R3/4	G1	1861 27 34	19	41	43.5	0.182

1873 Increaser, Male/Female NPT Thread

Stainless steel 316L

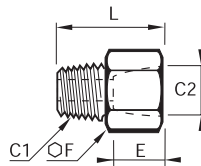

C1	C2		E	F	L	Kg
NPT1/8	NPT1/4	1873 11 14	14	17	25	0.024
	NPT3/8	1873 11 18	14	22	25	0.039
NPT1/4	NPT3/8	1873 14 18	14	22	28.5	0.042
	NPT1/2	1873 14 22	17.5	27	31	0.064
NPT3/8	NPT1/2	1873 18 22	17.5	27	31.5	0.064

1821 Equal and Unequal Adaptor, Male BSPT Thread

Stainless steel 316L

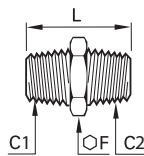

C1	C2		F	L	Kg
R1/8	R1/8	1821 10 10	12	19	0.009
R1/4	R1/8	1821 13 10	14	23.5	0.015
	R1/4	1821 13 13	14	27	0.019
R3/8	R1/4	1821 17 13	17	27.5	0.024
	R3/8	1821 17 17	17	28	0.023
R1/2	R3/8	1821 21 17	22	32.5	0.042
	R1/2	1821 21 21	22	36	0.047
R3/4	R1/2	1821 27 21	27	41	0.079
	R3/4	1821 27 27	27	42	0.088
R1	R3/4	1821 34 27	36	46	0.142
	R1	1821 34 34	36	48	0.146

Stainless Steel Adaptors

1821 Equal Adaptor, Male NPT Thread

Stainless steel 316L

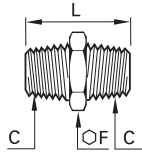

C		F	L	Kg
NPT1/8	1821 11 11	12	23	0.011
NPT1/4	1821 14 14	14	32	0.023
NPT3/8	1821 18 18	19	33	0.031
NPT1/2	1821 22 22	22	42	0.056
NPT3/4	1821 28 28	27	40	0.081
NPT1	1821 35 35	36	46	0.136

1823 Tailpipe Adaptor for Rubber Hose, Male BSPT Thread

Stainless steel 316L

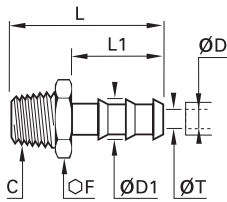

ØD	ØD1	C		F	L	L1	ØT	Kg
7	9	R1/8	1823 07 10	10	34	22.5	5	0.009
		R1/4	1823 07 13	14	38.5	22.5	6	0.017
10	12.2	R1/4	1823 10 13	14	38.5	22.5	7	0.018
		R3/8	1823 10 17	17	39	22.5	9.5	0.021
13	15	R3/8	1823 13 17	17	46	29.5	11	0.025
16	18.5	R1/2	1823 16 21	22	59	38	14	0.049

1823 Tailpipe Adaptor for Rubber Hose, Male NPT Thread

Stainless steel 316L

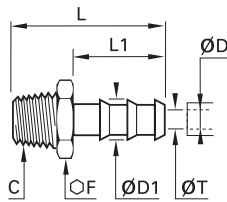

ØD	ØD1	C		F	L	L1	ØT	Kg
1/4	8.3	NPT1/8	1823 56 11	12	34	22.5	5.3	0.010
		NPT1/4	1823 56 14	14	38.5	22.5	5.3	0.016
3/8	11.7	NPT1/4	1823 60 14	14	38.5	22.5	8.5	0.018
		NPT3/8	1823 60 18	19	39	22.5	8.5	0.026

Brass Manifolds

0135

Manifold Block, Female BSP Thread

Brass

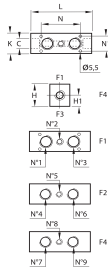

C		H	H1	K	L	N	Kg
G1/4	0135 06 13	30	13	25	70	37	0.335
	0135 09 13	30	13	25	87	54	0.409
G1/2	0135 06 21	40	16	35	86	45	0.714
	0135 09 21	40	16	35	109	68	0.899
G3/4	0135 10 27	45	21	40	122	78	1.232

This product is designed to distribute in several directions.

The number of ports can be increased by using tee pieces, cross pieces or double banjo couplings.

Installation Options

	F1			F2				F4				
	Number of Outlets	N°1	N°2	N°3	Number of Outlets	N°4	N°5	N°6	Number of Outlets	N°7	N°8	N°9
0135 06 13	1		G1/4		2	G1/8		G1/8	2	G1/8		G1/8
0135 09 13	2	G1/4		G1/4	3	G1/8	G1/8	G1/8	3	G1/8	G1/8	G1/8
0135 06 21	1		G1/2		2	G1/4		G1/4	2	G1/8		G1/8
0135 09 21	2	G1/2		G1/2	3	G1/4	G1/4	G1/4	3	G1/8	G1/8	G1/8
0135 10 27	3	G1/2	G1/8	G1/2	3	G1/8	G1/8	G1/8	3	G1/4	G1/8	G1/4

Anodised Aluminium Manifolds

3310 In-Line Manifold

Treated aluminium, NBR

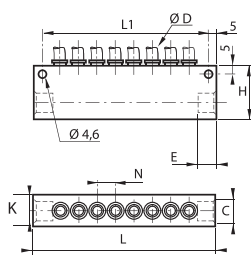

ØD	C		Number of Outlets	E	H	K	L	L1	N	Kg
4	G1/4	3310 04 13	8	10	33	20	114	104	11.5	0.164
6	G1/4	3310 06 13	8	10	33	20	114	104	12.5	0.170
8	G3/8	3310 08 17	6	12	33	20	114	104	15	0.148
10	G1/2	3310 10 21	6	16	48	25	145.5	135.5	17	0.334
12	G1/2	3310 12 21	6	16	45	25	158	148	20.5	0.370

3311 Manifold, Female BSPP and Metric Thread

Treated aluminium

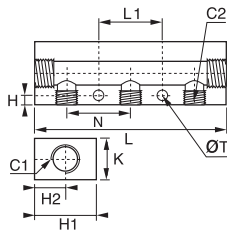

C1	C2		Number of Outlets	H	H1	H2	K	L	L1	N	ØT	Kg
G1/8	M5x0.8	3311 19 10 07	7	3.5	20	8.5	15	95	80	11	4.4	0.067
		3311 10 13 02	2	4.5	30	15	20	61	50	30	5	0.074
		3311 10 13 03	3	4.5	30	15	20	91	30	30	5	0.121
G1/4	G1/8	3311 10 13 04	4	4.5	30	15	20	121	60	30	5	0.165
		3311 10 13 05	5	4.5	30	15	20	151	90	30	5	0.209
		3311 10 13 06	6	4.5	30	15	20	181	120	30	5	0.244
G3/8	G1/4	3311 13 17 02	2	5.5	30	11	20	74	61	36	6.5	0.076
		3311 13 17 03	3	6	30	11	20	110	36	36	6.5	0.121
		3311 13 17 04	4	6	30	11	20	146	72	36	6.5	0.144
		3311 13 17 05	5	6	30	11	20	182	108	36	6.5	0.212
		3311 13 17 06	6	6	30	11	20	218	144	36	6.5	0.265

3312 Cross Manifold, Female BSPP and Metric Thread

Treated aluminium

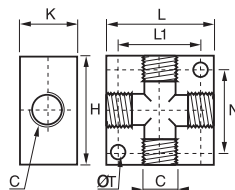

C		H	K	L	L1	N	ØT	Kg
M5x0.8	3312 00 19	20	10	20	12	12	4.5	0.010
G1/8	3312 00 10	30	16	30	23	22	4.5	0.029
G1/4	3312 00 13	40	20	40	30	27	5.5	0.061
G3/8	3312 00 17	50	25	50	38	39	6.5	0.125
G1/2	3312 00 21	50	25	50	38	39	6.5	0.101

3313 Double Manifold, Female BSPP Thread

Treated aluminium

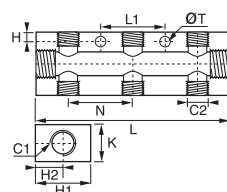

C1	C2		Number of Outlets	H	H1	H2	K	L	L1	N	ØT	Kg
G1/4	G1/8	3313 10 13 02	2x2	4.5	30	15	20	61	50	30	5	0.075
		3313 10 13 03	2x3	4.5	30	15	20	91	30	30	5	0.115
		3313 10 13 04	2x4	4.5	30	15	20	121	60	30	5	0.151
G3/8	G1/4	3313 10 13 05	2x5	4.5	30	15	20	151	90	30	5	0.194
		3313 13 17 02	2x2	6	40	20	20	74	61	36	6.5	0.109
		3313 13 17 03	2x3	6	40	20	20	110	36	36	6.5	0.179
G1/2	G1/4	3313 13 17 04	2x4	6	40	20	20	146	72	36	6.5	0.238
		3313 13 17 05	2x5	6	40	20	20	182	108	36	6.5	0.286
		3313 13 21 03	2x3	6	40	20	28	116	36	36	6.5	0.233
		3313 13 21 04	2x4	6	40	20	28	152	72	36	6.5	0.295
		3313 13 21 05	2x5	6	40	20	28	188	108	36	6.5	0.374

Anodised Aluminium Manifolds

3301 Modular Manifold

Treated aluminium, NBR

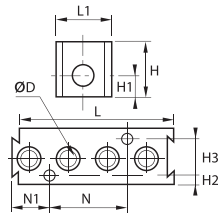

ØD		Number of Outlets	H	H1	H2	H3	L	L1	N	N1	Kg
4	3301 04 00	8	25	10	4.5	16	73.5	25	35	17	0.108
6	3301 06 00	4	25	10	4.5	16	73.5	25	35	17	0.110

Fixing with screw M3x20

3301 Manifold, Female BSPP Thread

Treated aluminium, NBR

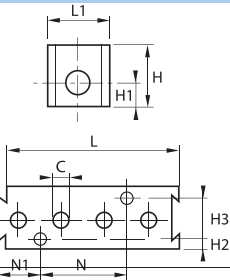

C		Number of Outlets	H	H1	H2	H3	L	L1	N	N1	Kg
G1/8	3301 07 10	4	25	10	4.5	16	73.5	25	35	17	0.097

Fixing with screw M3x20

NPT available on request

3302 Single Manifold, Female BSPP Thread

Treated aluminium, NBR

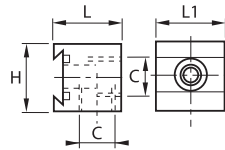

C		H	L	L1	Kg
G1/4	3302 01 13 01	25	24.5	25	0.031

3302 01 13: side entry thread

3302 01 13 01: rear entry thread

NPT available on request

3302 Double Manifold, Female BSPP Thread

Treated aluminium, NBR

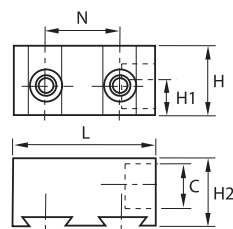

C		H	H1	H2	L	N	Kg
G3/8	3302 02 17	25	12.5	24.5	51	26	0.061

Side entry thread

NPT available on request

3302 Triple Manifold, Female BSPP Thread

Treated aluminium, NBR

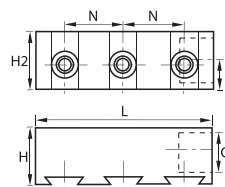

C		H	H1	H2	L	N	Kg
G3/8	3302 03 17	25	12.5	25	77	26	0.087

Lateral supply

NPT available on request

Anodised Aluminium Manifolds

3303

End Plate for Manifold

Treated aluminium

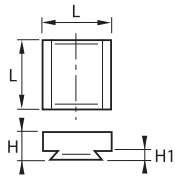

3303 00 01

H	H1	L	Kg
9.5	3.5	25	0.014

3303

Angled Fixing Plate

Treated aluminium

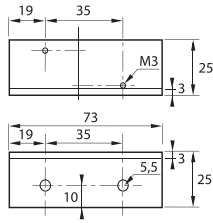

3303 00 02

Kg
0.029

Brass Plugs

0205 Internal Hexagon Head Plug, Male BSPT Thread

Brass

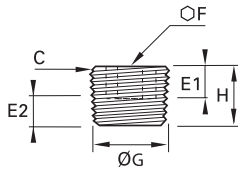

C		E1	E2 min	E2 max	F	G	H	Kg
R1/8	0205 10 00	6	3.1	4.9	5	9.7	8	0.003
R1/4	0205 13 00	8	4.7	7.3	6	13.2	10	0.007
R3/8	0205 17 00	8	5.1	7.7	8	16.7	11	0.013
R1/2	0205 21 00	8	6.4	10	10	21	13	0.026
R3/4	0205 27 00	11	7.7	11.3	14	26.4	17	0.054
R1	0205 34 00	13	8.1	12.7	17	33.2	19	0.094
R1 1/4	0205 42 00	14	10.4	15	22	41.9	22	0.178
R1 1/2	0205 49 00	14	10.4	15	24	47.8	22	0.246
R2	0205 48 00	16	13.6	18.2	30	59.6	25	0.431

For BSPT plug from 1/2" - 1 1/2" inclusive:

Conforms to DIN 906

Thread: EN 10226-1

0205 Internal Hexagon Head Plug, Male NPT Thread

Brass

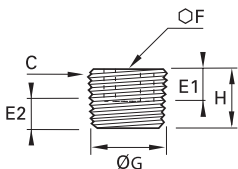

C		E1	E2 min	E2 max	F	G	H	Kg
NPT1/8	0205 11 00	6	3.2	5	5	10.2	8	0.003
NPT1/4	0205 14 00	8	4.4	7.2	6	13.6	10	0.008
NPT3/8	0205 18 00	8	4.7	7.5	8	17	11	0.014
NPT1/2	0205 22 00	8	6.3	9.9	10	21.2	13	0.026
NPT3/4	0205 28 00	11	6.8	10.4	14	26.6	17	0.052
NPT1	0205 35 00	13	8	12.4	17	33.2	19	0.091

HHP Internal Hexagon Head Plug, Male NPTF Thread, Heavy Series

Brass

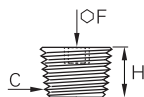

C		F*	H	Kg
NPTF1/4	1/4 HHP-B	1/4	12	0.009

*Inch dimensions **Max. working pressure: 260 bar

219P Hexagon Head Plug, Male NPTF Thread

Brass

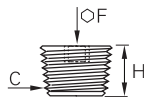

C		F*	H	Kg
NPTF1/8	219P-2	3/16	8	0.004
NPTF1/4	219P-4	1/4	12	0.009
NPTF3/8	219P-6	5/16	12	0.015

*Inch dimensions

0209 Square Head Plug, Male BSPT Thread

Brass

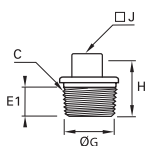

C		E1	E2 min	E2 max	G	H	J	Kg
R1/8	0209 10 00	6	3.1	4.9	9.7	16	6	0.007
R1/4	0209 13 00	8	4.7	7.3	13.2	18	8	0.014
R3/8	0209 17 00	10	5.1	7.7	16.7	20	10	0.025
R1/2	0209 21 00	11	6.4	10	21	22	13	0.047
R3/4	0209 27 00	15	7.7	11.3	26.4	28	17	0.097
R1	0209 34 00	18	8.1	12.7	33.2	32	19	0.169

Conforms to DIN 906

Thread: EN 10226-1

Brass Plugs

0220 Hex Head Plug, Male BSPP and Metric Thread

Brass, technical polymer

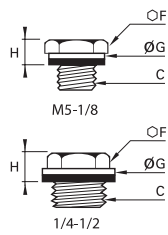

C		F	G	H1	Kg
M5x0.8	0220 19 00	8	8	5	0.002
G1/8	0220 10 00	14	14	7.5	0.011
G1/4	0220 13 00	17	17	7.5	0.019
G3/8	0220 17 00	17	22	8.5	0.024
G1/2	0220 21 00	22	27	10	0.041

Thread with pre-assembled sealing washer

M5: with screwdriver slot for tightening

Maximum allowable working pressure = 20 bar

Part number with suffix 99, maximum allowable working pressure = 250 bar, example: 0220 19 00 99

Conforms to BNA 229 (with the exception of M5 model), BSPP thread, ISO ISO 228-1,

Parallel metric thread, ISO NFE 03-054

0200 Hex Head Plug, Male BSPP and Metric Thread

Brass

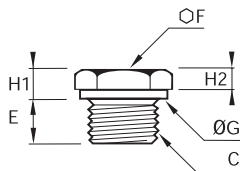

C		E	F	G	H1	H2	Kg
M6x1	0200 52 00	6	10	10	4	3.5	0.004
M8x1.25	0200 57 00	7	13	13	4	3.5	0.007
M10x1	0200 60 00	8	14	14	5	4.5	0.011
M12x1	0200 65 00	9	17	17	5	4.5	0.018
M12x1.25	0200 66 00	9	17	17	5	4.5	0.018
G1/8	0200 10 00	7	14	13.7	5.5	4	0.011
G1/4	0200 13 00	8.5	17	16.7	5.5	4	0.019

Brass Plugs

0201

Hex Head Plug with Collar, Male BSPP and Metric Thread

Brass

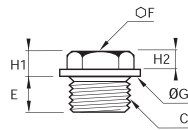

C		E	F	G	H1	H2	Kg
M16x1.5	0201 75 00	10	17	22	6.5	5	0.025
M18x1.5	0201 78 00	10	17	24	7	5	0.027
M20x1.5	0201 80 00	10	17	26	7.5	5	0.031
M22x1.5	0201 82 00	10	22	30	7.5	5	0.044
M24x1.5	0201 83 00	10	22	32	7.5	5	0.048
M24x2	0201 92 00	10	22	32	7.5	5	0.046
M30x2	0201 88 00	11	27	38	8.5	6	0.075
G3/8	0201 17 00	10	17	21.7	6.5	4.5	0.024
G1/2	0201 21 00	10	22	26.7	7.5	5	0.041
G3/4	0201 27 00	11	22	31.7	8.5	6	0.058
G1	0201 34 00	11	27	39.7	8.5	6	0.086
G1 1/4	0201 42 00	12	30	49.7	10	7	0.142

HP3

Hexagon Head Plug, Male BSPT Thread

Brass

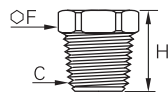

C		F	H	Kg
R1/8	1/8HP3B	10	12	0.007
R1/4	1/4HP3B	14	16	0.018
R3/8	3/8HP3B	17	17	0.029
R1/2	1/2HP3B	22	21	0.059
R3/4	3/4HP3B	27	24	0.110
R1	1HP3B	36	27	0.196

218P

Hexagon Head Plug, Male NPTF Thread, Heavy Series

Brass

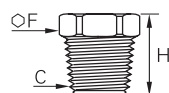

C		F	H	Kg
NPTF1/8	218P-2	7/16	14	0.008
NPTF1/4	218P-4	9/16	19	0.020
NPTF3/8	218P-6	11/16	20	0.033
NPTF1/2	218P-8	7/8	25	0.058

*Inch dimensions

0202

Internal Hexagon Head Plug with Collar, Male Metric Thread

Brass

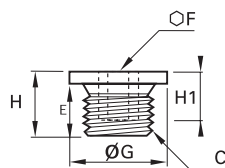

C		E	F	G	H	H1	Kg
M12x1	0202 65 00	9	6	17	11	8	0.009
M12x1.25	0202 66 00	9	6	17	11	8	0.009
M14x1.5	0202 71 00	10	6	19	13	10	0.015
M16x1.5	0202 75 00	10	8	22	13	10	0.019
M18x1.5	0202 78 00	10	10	24	13	10	0.022
M20x1.5	0202 80 00	10	12	26	13	10	0.025
M22x1.5	0202 82 00	10	12	30	13	10	0.034
M27x2	0202 86 00	11	17	35	15	11	0.052
M30x2	0202 88 00	11	19	38	15	11	0.062

Parallel metric threads, ISO standard NFE 03-054

Nickel-Plated Brass Plugs

0936 Internal Hexagon Head Plug, Male BSPT Thread

Nickel-plated brass

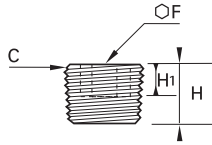

C		F	H	Kg
R1/8	0936 00 10	5	8	0.003
R1/4	0936 00 13	6	10	0.007
R3/8	0936 00 17	8	11	0.013
R1/2	0936 00 21	10	13	0.026

0919 Internal Hexagon Head Plug, Male BSPP and Metric Thread

Nickel-plated brass

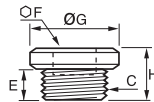

C		E	F	G	H	Kg
M5x0.8	0919 00 19	4	2.5	8	6.5	0.001
G1/8	0919 00 10	6	5	15	9.5	0.007
G1/4	0919 00 13	8	6	18	11.5	0.013
G3/8	0919 00 17	9	8	21	13	0.021
G1/2	0919 00 21	10	10	25	14.5	0.035
G3/4	0919 00 27	11	14	31	15.5	0.049
G1	0919 00 34	13	17	38	17.5	0.072

0938 External Hexagon Head Plug, Male BSPP Thread

Nickel-plated brass

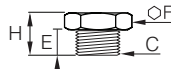

C		E	F	H	Kg
M5x0.8	0938 00 19	4	8	7	0.002
G1/8	0938 00 10	6	14	10	0.007
G1/4	0938 00 13	8	17	12.5	0.014
G3/8	0938 00 17	9	19	13.5	0.020
G1/2	0938 00 21	10	24	15.5	0.031
G3/4	0938 00 27	11	30	16.5	0.050
G1	0938 00 34	13	38	19	0.100

FN4 Hexagon Head End Plug, Male BSPP Thread

Nickel-plated brass

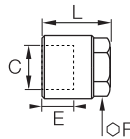

C		E	F	L	Kg
G1/8	1/8FN4BL	7.5	12	11	0.005
G1/4	1/4FN4BL	11	14	19	0.015
G1/2	1/2FN4BL	14	19	22	0.040

Steel Plugs

0206 Internal Hexagon Head Plug, Male BSPT Thread

Steel

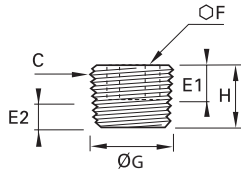

C		E1	E2 _{min}	E2 _{max}	F	G	H	Kg
R1/8	0206 10 00	6	3.1	4.9	5	9.7	8	0.003
R1/4	0206 13 00	8	4.7	7.3	6	13.2	10	0.007
R3/8	0206 17 00	8	5.1	7.7	8	16.7	11	0.012
R1/2	0206 21 00	8	6.4	10	10	21	13	0.023
R3/4	0206 27 00	11	7.7	11.3	14	26.4	17	0.048
R1	0206 34 00	13	8.1	12.7	17	33.2	19	0.085
R1 1/4	0206 42 00	14	10.4	15	22	41.9	22	0.166
R1 1/2	0206 49 00	14	10.4	15	24	47.8	22	0.222

For BSPT plugs, from 1/2" - 1 1/2" inclusive

Conforms to DIN 906

Thread, conforms to EN 10226-1

0206 Internal Hexagon Head Plug, Male NPT Thread

Steel

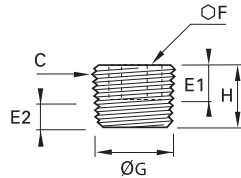

C		E1	E2 _{min}	E2 _{max}	F	G	H	Kg
NPT1/16	0206 08 00	6	3.8	6.4	4	7.8	7	0.002
NPT1/8	0206 11 00	6	3.2	5	5	10.2	8	0.003
NPT1/4	0206 14 00	8	4.4	7.2	6	13.6	10	0.007
NPT3/8	0206 18 00	8	4.7	7.5	8	17	11	0.012
NPT1/2	0206 22 00	8	6.3	9.9	10	21.2	13	0.023
NPT3/4	0206 28 00	11	6.8	10.4	14	26.6	17	0.048
NPT1	0206 35 00	13	8	12.4	17	33.2	19	0.082

0210 Hex Head Plug, Male BSPP and Metric Thread

Steel

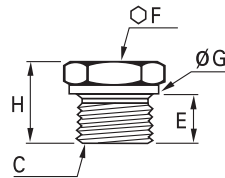

C		E	F	G	H	Kg
M8x1.25	0210 57 00	8	14	12	15	0.011
M10x1	0210 60 00	8	14	14	15	0.013
M12x1.25	0210 66 00	11	17	17	18	0.021
G1/8	0210 10 00	8	14	14	15	0.013
M14x1.25	0210 70 00	11	19	19	20	0.032
G1/4	0210 13 00	12	19	18	21	0.031
G3/8	0210 17 00	12	22	22	21	0.046
G1/2	0210 21 00	14	27	26	24	0.078
G3/4	0210 27 00	16	32	32	27	0.134
G1	0210 34 00	18	41	39	33	0.269
G1 1/4	0210 42 00	20	50	49	35	0.441

Profile of head undercut conforms to DIN 3852-1, form D/E

BSPP threads, ISO 228-1

Parallel metric threads, NFE 03-054

0216 Hex Head Plug, Male BSPT Thread

Steel

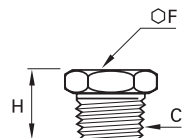

C		F	H	Kg
R1/8	0216 10 00	13	16	0.012
R1/4	0216 13 00	17	19	0.023
R3/8	0216 17 00	19	21	0.038
R1/2	0216 21 00	22	23	0.060

BSPT thread conforms to EN 10226-1





Steel Plugs

0216

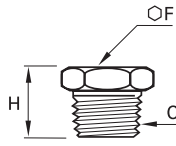
Hex Head Plug, Male NPT Thread

Steel



C		F	H	Kg
NPT1/8	 0216 11 00	13	16	0.012
NPT1/4	 0216 14 00	17	19	0.023
NPT3/8	 0216 18 00	19	21	0.038
NPT1/2	 0216 22 00	22	23	0.060

Stainless Steel Plugs

0285 Internal Hexagon Head Plug, Male BSPT Thread

Stainless steel 316L

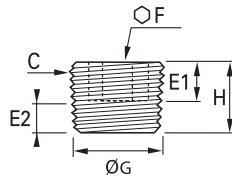

C		E1	E2 min	E2 max	F	G	H	Kg
R1/8	0285 10 00	6	3.1	4.9	5	9.7	8	0.003
R1/4	0285 13 00	8	4.7	7.3	6	13.2	10	0.007
R3/8	0285 17 00	8	5.1	7.7	8	16.7	11	0.013
R1/2	0285 21 00	8	6.4	10	10	21	13	0.024
R3/4	0285 27 00	11	7.7	11.3	14	26.4	17	0.051
R1	0285 34 00	13	8.1	12.7	17	33.2	19	0.089

0285 Internal Hexagon Head Plug, Male NPT Thread

Stainless steel 316L

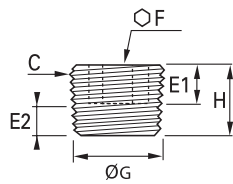



C		E1	E2 min	E2 max	F	G	H	Kg
NPT1/8	0285 11 00	6	3.2	5	5	10.2	8	0.003
NPT1/4	0285 14 00	8	4.4	7.2	6	13.6	10	0.007
NPT3/8	0285 18 00	8	4.7	7.5	8	17	11	0.013
NPT1/2	0285 22 00	8	6.3	9.9	10	21.2	13	0.025

Sealing Accessories

0138 Copper Washer

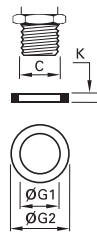
Copper





C		G1	G2	K	Kg
M6	0138 06 00	6.3	9	1	0.033
M8	0138 08 00	8.3	11	1	0.001
M12	0138 12 00	12.3	15.5	1.3	0.001
M14	0138 14 00	14.3	18	1.5	0.001
M16	0138 16 00	16.3	20	1.5	0.001
M18	0138 18 00	18.3	22	1.5	0.001
M20	0138 20 00	20.3	24	1.5	0.001
M22	0138 22 00	22.3	27	1.5	0.002
M24	0138 24 00	24.3	29	2	0.003
M26	0138 26 00	26.3	31	2	0.003
M30	0138 30 00	30.3	36	2	0.004
M36	0138 36 00	36.3	42	2	0.005
M39	0138 39 00	39.3	44	2	0.007
M45	0138 45 00	45.3	52	2	0.008
M52	0138 52 00	52.3	60	2	0.009
G1/8	0138 10 00	10.3	13.5	1	0.001
G1/4	0138 13 00	13.5	18	1.3	0.001
G3/8	0138 17 00	17.3	21	1.5	0.001
G1/2	0138 21 00	21.3	26	1.5	0.002
G3/4	0138 27 00	27.3	32	2	0.003
G1	0138 33 00	33.5	39	2	0.005
G1 1/4	0138 42 00	42.5	49	2	0.007
G1 1/2	0138 48 00	48.3	55	2	0.008
G2	0138 60 00	60	68	2.5	0.014

DIN 7603
ISO 65061

0137 Bonded Seal

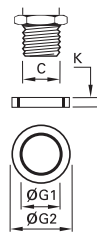
Zinc-plated steel with NBR seal



C		G1	G2	K	Kg
M12	0137 12 00	12.7	19	1.5	0.001
M14	0137 14 00	14.7	21	1.5	0.001
M16	0137 16 00	16.7	23	1.5	0.002
M18	0137 18 00	18.7	27	2	0.004
M20	0137 20 00	20.7	29	2	0.004
M22	0137 22 00	22.7	31	2	0.005
M24	0137 24 00	24.7	33	2	0.005
M30	0137 30 00	30.7	39	2	0.071
M39	0137 39 00	40	51	2.5	0.012
M45	0137 45 00	46	57	2.5	0.014
G1/8	0137 10 00	10.7	17	1.5	0.001
G1/4	0137 13 00	13.7	20.6	2.1	0.002
G3/8	0137 17 00	17.4	23.7	1.5	0.002
G1/2	0137 21 00	21.5	28.6	2.5	0.004
G3/4	0137 27 00	27	35.3	2	0.007
G1	0137 33 00	33.7	42	2	0.007
G1 1/4	0137 42 00	43	54	2.5	0.013
G1 1/2	0137 48 00	49	60	2.5	0.015
G2	0137 60 00	60.7	73	3	0.027

Note: to use these bonded seals successfully it is necessary to spot face around the female thread to provide a sealing "land".

The diameter should be 0.3 mm to 0.5 mm greater than the external diameter of the seal.

The surface finish of the thread should not exceed 12 µ.

Sealing Accessories

0605 Fluoropolymer Tape

FKM



Kg

0605 12 12

0.012

Can be used for temperatures from - 250°C to +260°C.

Chemically inert and resistant to gases, acids, solvents, hydrocarbons, oils, alkalines, steam etc.

Non-toxic, waterproof, self-lubricating.

In accordance with CFR21.

Can be used on all materials.

Used to facilitate the preparation of leak-free threaded joints.

Supplied on a reel, length = 12 m, width = 12.7 mm, thickness 0.08 mm.

0602 Captive Sealing Washer

Technical polymer

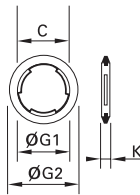

C



G1

G2

K

Kg

M5x0.8	0602 29 93 15	5.2	7.8	1.5	0.001
G1/8	0602 23 10 20	10.3	14	2	0.001
G1/4	0602 23 11 20	13.7	17.5	2	0.001
G3/8	0602 23 12 20	17.2	21	2	0.001
G1/2	0602 23 13 20	21.5	25.5	2.5	0.002
G3/4	0602 27 32 20	27	32	2.5	0.001
G1	0602 30 60 20	33.8	39	3	0.001

Maximum allowable working pressure: 20 bar

0139 Bi-Material Captive Sealing Washer

Zinc-plated steel with NBR seal

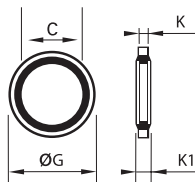

C



G

K

K1

Kg

G1/8	0139 10 00	14	1	1.7	0.001
G1/4	0139 13 00	17	1	1.7	0.001
G3/8	0139 17 00	22	1.2	2.1	0.001
G1/2	0139 21 00	26	1.6	2.5	0.002
G3/4	0139 27 00	32	1.5	2.5	0.003
G1	0139 34 00	39.6	1.7	2.6	0.003

Maximum allowable working pressure: 250 bar

Technical characteristics of captive seals **0602**

Tightening torque



	M5x0.8	G1/8	G1/4	G3/8	G1/2	G3/4	G1
Min. Torque in daN.m	0.06	0.08	0.3	0.5	1	1.2	1.9
Max. Torque daN.m	0.16	0.8	1.2	3	3.5	6	9

Tube Supports

0127

Brass Tube Support for Polymer Tubing

Brass

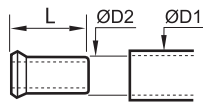

	ØD1	ØD2		L	Kg
4	2	0127 04 00		11	0.001
	2.7	0127 04 27		11	0.001
5	3	0127 05 03		11	0.001
	3.3	0127 05 00		11.5	0.009
6	4	0127 06 00		11.5	0.001
	5.5	0127 08 55		14	0.001
8	6	0127 08 00		14	0.001
	7	0127 10 07		18	0.001
10	7.5	0127 10 75		18	0.001
	8	0127 10 00		18	0.002
12	8	0127 12 08		18	0.002
	9	0127 12 09		18	0.001
14	10	0127 12 00		18	0.001
	11	0127 14 11		18	0.002
16	12	0127 14 00		18	0.002
	12	0127 15 12		18	0.002
18	13	0127 16 13		18	0.003
	14	0127 18 14		19.5	0.003
20	15	0127 20 15		20.5	0.003
	16	0127 22 16		21	0.004
25	19	0127 25 19		25	0.007

This tube support guarantees good gripping, at high temperatures and pressures, by preventing collapsing of the tube.

1827

Stainless Steel Tube Support for Fluoropolymer Tubing

Stainless steel 316L

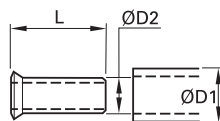

	ØD1	ØD2		L	Kg
6	4	1827 06 00		11.5	0.001
8	6	1827 08 00		14	0.001
10	8	1827 10 00		18	0.001
12	9	1827 12 09		18	0.001
	10	1827 12 00		18	0.001
16	14	1827 16 00		18	0.002

This tube support is necessary when using fluoropolymer tubing at all temperatures compatible with the fitting/tubing assembly.



Together, we can connect you to the best in technology

Inventor of the push-in fitting with more than 40 years of experience, Parker Legris has the know-how necessary for providing fluid connectors adapted to a wide variety of environments, such as production automation, packaging, transport, food process and the medical industry. Our wide selection of fittings, tubing, ball valves and accessories, along with our capacity to develop specific products, allow our customers to find the very best connector solution. Parker Legris, the right partner to accompany you in product development.

aerospace
climate control
electromechanical
filtration
fluid & gas handling
hydraulics
pneumatics
process control
sealing & shielding



ENGINEERING YOUR SUCCESS.

www.parkerlegris.com

Index

Part Number	Page	0222	1-37	0904	9-18	3082	2-8	3303	9-29	4991	6-23
		0285	9-36	0905	9-18	3086	2-8	3304	1-21	4992	6-23
0101	5-10, 11	0400	6-10	0906	9-18	3088	2-9	3306	1-21	6101	1-109
0102	5-16	0401	6-10	0907	9-19	3089	2-8	3310	1-21, 9-27	6104	1-110
0103	5-13	0402	6-10	0908	9-17	3091	1-35	3311	9-27	6105	1-109
0104	5-17	0411	6-10	0909	9-17	3100	1-16, 2-8	3312	9-27	6106	1-110
0105	5-9	0414	6-10	0910	9-15	3101	1-8	3313	9-27	6114	1-109
0106	5-15	0432	6-15	0911	9-15	3102	1-17	3320	1-31	6179	1-109
0107	5-17	0436	6-15	0912	9-14	3103	1-14	3321	1-31	6270	1-75
0108	5-13	0437	6-15	0913	9-14	3104	1-18	3329	1-31	6271	1-77
0109	5-12	0438	6-15	0914	9-15	3106	1-17	3379	1-32	6273	1-75
0110	5-22	0439	6-15	0915	9-15	3107	1-19	3381	1-32	6274	1-79
0111	5-21	0446	6-11	0916	9-16	3108	1-14	3391	1-35	6276	1-81
0112	5-28	0448	6-12	0917	9-16	3109	1-10, 11	3524	1-29	6300	1-50, 2-10
0113	5-16	0449	6-13	0919	9-33	3110	1-37, 60	3527	1-29	6302	1-54
0114	5-11	0452	6-12	0920	9-19	3112	1-16	3528	1-29	6304	1-55
0116	5-16	0461	6-14	0921	9-14	3113	1-13	3529	1-29	6306	1-54
0117	9-8	0462	6-14	0922	9-14	3114	1-9	3538	1-28	6307	1-56
0118	5-14	0465	6-29	0923	9-15	3116	1-20	3539	1-28	6315	1-48, 49
0119	5-15	0469	6-13	0924	9-16	3118	1-27	3549	1-28	6316	1-56
0120	5-28	0471	6-11	0927	9-16	3119	1-27	3600	1-98, 2-13	6322	1-59
0121	9-11	0472	6-11	0928	9-16	3120	1-24	3601	1-97	6325	1-49
0122	5-26	0482	6-12	0929	9-12	3121	1-9	3602	1-102	6326	1-58, 59
0123	9-12	0483	6-12	0931	9-20	3122	1-25	3603	1-100	6331	1-63
0124	5-21	0489	6-13	0932	9-17	3124	1-27	3604	1-102	6332	1-63
0125	5-27	0490	6-17	0933	9-18	3126	1-25, 93	3606	1-102	6333	1-63
0126	5-27	0491	6-17	0934	9-21	3129	1-12	3608	1-100	6336	1-63
0127	3-47, 5-30, 9-39	0492	6-17	0935	9-21	3130	1-37, 60, 81	3609	1-99	6340	1-55
0132	5-25	0494	6-18	0936	9-33	3131	1-10	3610	1-105	6351	1-59
0134	5-25	0496	6-18	0938	9-33	3132	1-16	3614	1-98	6352	1-49
0135	9-26	0497	6-18	1802	5-36	3133	1-13	3616	1-103	6353	1-49
0136	9-13	0501	6-39	1804	5-36	3136	1-20	3618	1-101	6355	1-53
0137	9-37	0502	6-39	1805	5-34	3139	1-20	3620	1-104	6366	1-58
0138	1-110, 9-37	0510	6-39	1806	5-36	3140	1-18	3621	1-98	6368	1-58
0139	9-38	0531	6-39	1809	5-35	3142	1-23	3622	1-104	6380	1-57
0142	5-17	0532	6-39	1810	5-39	3143	1-23	3626	1-105	6382	1-57
0143	9-7	0562	6-40	1814	5-34	3144	1-21	3629	1-99	6383	1-57
0144	9-7	0563	6-40	1816	5-36	3146	1-20	3631	1-98	6388	1-57, 58
0145	9-7	0591	6-41	1817	9-22	3148	1-15	3636	1-103	6401	6-11
0152	9-7	0602	9-38	1820	5-35	3149	1-27	3639	1-103	6402	6-11
0155	9-8	0605	1-60, 105, 123, 9-38	1821	9-24, 25	3150	8-23	3666	1-104	6503	1-53
0158	9-8	0622	7-15	1822	5-39	3151	1-25, 77	3667	1-104	6505	1-48
0163	9-10	0623	7-15	1823	9-25	3158	1-15	3668	1-104	6508	1-52, 53
0164	5-47, 8-31, 9-9	0627	6-40	1824	5-39	3159	1-35	3669	1-100	6509	1-51, 52
0165	5-26	0630	6-40	1827	3-47, 5-39, 9-39	3160	1-35	3675	1-97	6521	1-50
0166	5-20	0651	7-9	1843	9-22	3166	1-24	3681	1-97	6579	1-51
0167	8-31, 9-9	0652	7-8	1844	9-22	3168	1-24	3693	1-101	6901	1-68
0168	9-9	0653	7-8, 7-10	1845	9-22	3169	1-13	3698	1-100	6903	1-70
0169	9-10	0654	7-7, 7-10	1855	9-23	3175	1-7, 8	3699	1-99	6905	1-68
0171	8-22, 23	0655	7-8	1861	9-24	3180	1-22	3800	1-123	6908	1-69
0172	8-24, 25	0656	7-9, 7-10	1862	9-23	3181	1-8	3803	1-119	6909	1-69
0178	1-37	0657	7-9	1863	9-24	3182	1-22	3805	1-115	6911	1-65
0180	8-23	0658	7-9	1864	9-23	3183	1-23	3808	1-120	6953	1-67
0181	8-22, 23	0659	7-7, 7-10	1866	5-39	3184	1-22	3809	1-117	6958	1-66
0183	8-22	0669	4-59	1867	9-23	3188	1-23	3821	1-116	6959	1-65
0184	8-22	0670	4-63	1870	9-23	3189	1-35	3826	1-123	6973	1-67
0185	8-24	0671	4-64	1871	9-22	3192	1-12	3889	1-118	6975	1-65
0186	8-24	0672	4-64	1872	9-24	3193	1-15	4020	6-35	6978	1-66
0187	8-24	0673	4-63	1873	9-24	3198	1-14	4021	6-35	6979	1-66
0189	8-24	0674	4-63	2203	8-27	3199	1-11	4022	6-35	6993	1-70
0191	9-20	0675	4-63	2270	8-27	3202	1-43	4023	6-35	6998	1-69
0192	9-20	0676	4-63	2272	8-25, 29	3204	1-43	4024	6-35	6999	1-68
0195	8-26	0677	4-64	2292	8-27	3206	1-43	4298	6-49	7000	4-16, 55, 6-33
0196	8-26	0681	8-31	2293	8-26	3218	1-42	4299	6-49	7010	4-10
0199	5-12	0682	4-64	2294	8-25, 29	3226	1-43	4402	6-31	7011	4-10
0200	9-31	0683	4-64	2295	8-26, 29	3229	1-41	4602	6-43	7012	4-10
0201	9-32	0691	8-31	2296	8-26	3266	1-43	4810	6-29	7020	4-17
0202	9-32	0694	3-39, 46	2297	8-25, 29	3281	1-41	4812	6-29	7030	4-18
0205	9-30	0695	3-39, 46	2299	7-15, 8-28	3293	1-41	4832	6-29	7031	4-18
0206	9-34	0697	3-47	2398	8-27	3298	1-41	4890	4-47	7040	4-14
0209	9-30	0900	9-19	2511	8-25	3299	1-41	4891	4-47	7041	4-14
0210	9-34	0901	9-19	3000	1-37, 123	3300	1-31	4892	4-47	7045	4-14
0216	9-34, 35	0902	9-20	3018	1-27	3301	9-28	4895	4-47	7060	4-11
0220	5-27, 31	0903	9-17	3081	2-9	3302	9-28	4902	6-23	7061	4-11

Index

7062	4-12	7995	4-41	1100U..R	3-20	9084A	8-16	KRRS3	9-17
7065	4-11	7996	4-41	1100U..A	3-23	9086A	8-16	MM08BKT	1-90
7066	4-11	0101..39	5-10	1100U..K	3-25	9086E	8-14	MMS8UB	1-90
7067	4-12	0110..40	5-22	1100U..V	3-25	9086U	8-11	MRO434	9-7
7100	4-20	0110..60	5-22	1100Y	3-27	9087A	8-16	MRO8UB	1-90
7101	4-20	0110..70	5-22	1420U	3-33	9087E	8-14	P8UNBL	1-93
7110	4-20	0118..39	5-14	1441U..R	3-38	9087U	8-11	PPRC8UM	1-92
7111	4-21	0119..39	5-15	1442U..E	3-41	9094A	8-17	PPRF8UM	1-92
7130	4-19	0124..40	5-21	1442U..R	3-38	9094E	8-14	PPRV8UM	1-92
7140	4-19	0128..39	5-29	1445U..E	3-41	9094U	8-12	R3BPL	5-45
7160	4-19	0133..39	5-25	1445U..R	3-38	9401A	8-15	R68UNPMK	1-85
7170	4-21	0151..39	5-29	1447U..E	3-41	9401E	8-13	S3BPL	5-45
7180	4-20	0168..39	5-29	1447U..R	3-38	9401U	8-10	S8UNPMB	1-88
7190	4-21	0220..39	5-27	1460U	3-37	9405A	8-15	S8UNPMBPPAM	1-88
7300	4-53	0491..64	6-17	1461U	3-37	9405U	8-10	T2ENPMB	1-89
7316	4-55	0492..64	6-17	1462U	3-37	9410A	8-15	TLT	2-13
7318	4-55	0631..01	7-17	1470P	3-35	9410E	8-13	V68UNPMK	1-85
7416	4-55	0631..02	7-18	1470U	3-37	9410U	8-10	V8UNPMB	1-88
7471	4-55	0631..03	7-18	1471P	3-35	9414A	8-15	VDPF8UM	1-93
7630	4-18	0631..04	7-18	1471U	3-37	9414E	8-13	WBPL	5-47
7631	4-18	0631..05	7-18	1472P	3-35	9414U	8-10	WBPL-1	5-47
7640	4-15	0631..06	7-19	1472U	3-37	9416A	8-16	WEONPMB	1-87
7645	4-15	0631..07	7-19	2003U	3-19	9416E	8-13	WG8F8UB	1-92
7649	4-15	0631..08	7-19	2003U..R	3-20	9416U	8-11	WGG88B	1-92
7660	4-13	0631..09	7-17	2005P	3-11	9421A	8-15	WLNB	1-93
7662	4-14	0631..23	7-17	2005U	3-19	9421E	8-13	WNPMB	1-89
7665	4-13	0631..30	7-17	2005U..R	3-20	9421U	8-10		
7668	4-13	0690 01	7-11	2010P	3-11	9440A	8-16		
7669	4-13	0690 02	7-11	2010U	3-19	9440E	8-14		
7680	4-20	0690 03	7-11	2010U..R	3-20	9440U	8-11		
7762	4-21	0690 04	7-11	207ACBH	9-8	BPLM	5-47		
7770	4-16	0690 05	7-11	207P	9-9	BPLM-M	5-47		
7771	4-16	0690 06	7-12	209P	9-10	BVG4-L	6-21		
7772	4-16	0690 06 01	7-12	216P	9-12	BVG4-LOCK	6-24		
7776	4-16	0690 07	7-12	218P	9-32	BVG4P-LOCK	6-24		
7800	4-59	0690 08	7-12	219P	9-30	BVGT4-C	6-23		
7801	4-59	0690 09	7-12	222P	9-11	BVGT4-L	6-21		
7802	4-59	0690 10	7-13	3000 70 00	1-105	C3BPL	5-44		
7810	4-23	0690 11	7-13	3000 71 00	3-46	C3BPL-1	5-44		
7812	4-23	1005T	3-29	3000 71 11	3-46	C4BPL	5-44		
7818	4-51	1010P..M	3-33	3151..03	1-77	C68UNPMK	1-85		
7820	4-23	1010T..A	3-31	3800/3900	1-117, 2-13	C8BPL-1	5-44		
7822	4-23	1010T..P	3-31	3801/3901	1-115	C8UNPMB	1-88		
7828	4-51	1015Y..F	3-27	3802/3902	1-121	CLIP	1-37, 3-47		
7860	4-49	1025L	3-12	3803/3903	1-119	COR4BPL	5-45		
7861	4-49	1025P	3-11	3804/3904	1-121	D8C8UB	1-90		
7870	4-49	1025P..V	3-17	3805/3905	1-115	D8V8UB	1-90		
7871	4-49	1025T	3-29	3806/3906	1-121	DD44BKTL	9-14		
7880	4-37	1025U	3-19	3808/3908	1-119	F2NPMB	1-87		
7881	4-37	1025U..A	3-23	3809/3909	1-117	F3BPL	5-43		
7883	4-37	1025U..K	3-25	3816/3916	1-122	F3BPL-1	5-43		
7885	4-37	1025U..R	3-20	3821/3921	1-116	F4BPL	5-43		
7886	4-37	1025U..V	3-25	3831/3931	1-116	F8BPL	5-43		
7892	4-39	1025V	3-43	3866/3966	1-123	F8BPL-1	5-43		
7894	4-39	1025V..C	3-43	3879/3979	1-118	F8UGB	1-91		
7899	4-61	1030Y..F	3-27	3889/3989	1-118	F8UG4B	1-91		
7910	6-33	1040H	3-45	3893/3993	1-119	F8UG8B	1-91		
7911	6-33	1050P..M	3-33	3898/3998	1-120	F8UHA8UB	1-91		
7913	6-33	1050T..A	3-31	3899/3999	1-117	F8UNPMB	1-87		
7914	6-33	1050T..P	3-31	4202..20	6-48	FF44	9-11		
7921	4-57	1050V	3-43	4202..30	6-48	FG43	9-10		
7926	4-57	1050V..C	3-43	4212..20	6-48	FN4	9-33		
7930	4-43	1075Y..F	3-27	4212..30	6-48	FTL	2-13		
7931	4-43	1080H	3-45	4222..20	6-49	GG-B	9-9		
7932	4-43	1096Y..F	3-27	4222..30	6-49	HBPL	5-46		
7960	4-57	1098Y..F	3-27	6000 71 00	3-17, 25, 46	HBPL-1	5-46		
7961	4-57	1099Y..F	3-27	6270..03	1-75	HHP	9-30		
7970	4-61	1100H	3-45	6271..03	1-77	HNPMB	1-89		
7971	4-61	1100P	3-11	6273..03	1-75	HP3	9-32		
7984	4-41	1100P..R	3-15	9071U	8-31	JBPL	5-46		
7985	4-41	1100P..V	3-17	9080A	8-17	JBPL-1	5-46		
7992	4-45	1100T..P	3-31	9080E	8-14	JNPMB	1-89		
7994	4-41	1100U	3-19	9080U	8-12	JNPMK	1-85		

Parker Safety Guide

User Responsibility

Selection and Use of Fittings, Function Fittings, Tubing and Related Products

WARNING: Failure or improper selection or improper use of fittings, function fittings, tubing or related products ("Products") can cause death, personal injury and property damage.

Possible consequences of failure or improper selection or improper use of these Products include but are not limited to:

- Fittings thrown off at high speed.
- High velocity fluid discharge.
- Explosion or burning of the conveyed fluid.
- Electrocutation from high voltage electric power lines.
- Contact with suddenly moving or falling objects that are controlled by the conveyed fluid.
- Injections by high pressure fluid discharge.
- Dangerously whipping tubing.
- Contact with conveyed fluids that may be hot, cold, toxic or otherwise injurious.
- Sparking or explosion caused by static electricity build-up or other sources of electricity.
- Sparking or explosion while spraying paint or flammable liquids.
- Injuries resulting from inhalation, ingestion or exposure to fluids.
- Dynamic applications with strong oscillation.

The user, through his own analysis and testing, is solely responsible for making the final selection of the system and components and assuring that all performance, endurance, maintenance, safety and warning requirements of the application are met. The user must analyze all aspects of the application, follow applicable industry standards, and follow the information concerning the product in the current product catalog and in any other materials provided from Parker or its subsidiaries or authorized distributors.

To the extent that Parker or its subsidiaries or authorized distributors provide component or system options based upon data or specifications provided by the user, the user is responsible for determining that such data and specifications are suitable and sufficient for all applications and reasonably foreseeable uses of the components or systems.

Parker Legris has a continuous product development policy and therefore reserves the right to modify products shown in this catalogue. Please treat all dimensions and photos therefore as indicative.

Photography Credits:

Jochen Detscher

Graphic Design:

Sylvain Fromentin



Parker's Motion & Control Technologies

At Parker, we're guided by a relentless drive to help our customers become more productive and achieve higher levels of profitability by engineering the best systems for their requirements. It means looking at customer applications from many angles to find new ways to create value. Whatever the motion and control technology need, Parker has the experience, breadth of product and global reach to consistently deliver. No company knows more about motion and control technology than Parker. For further info call 00800 27 27 5374



Aerospace

Key Markets

Aftermarket services
Commercial transports
Engines
General & business aviation
Helicopters
Launch vehicles
Military aircraft
Missiles
Power generation
Regional transports
Unmanned aerial vehicles

Key Products

Control systems & actuation products
Engine systems & components
Fluid conveyance systems & components
Fluid metering, delivery & atomization devices
Fuel systems & components
Fuel tank inerting systems
Hydraulic systems & components
Thermal management
Wheels & brakes



Climate Control

Key Markets

Agriculture
Air conditioning
Construction Machinery
Food & beverage
Industrial machinery
Life sciences
Oil & gas
Precision cooling
Process
Refrigeration
Transportation

Key Products

Accumulators
Advanced actuators
CO₂ controls
Electronic controllers
Filter driers
Hand shut-off valves
Heat exchangers
Hose & fittings
Pressure regulating valves
Refrigerant distributors
Safety relief valves
Smart pumps
Solenoid valves
Thermostatic expansion valves



Electromechanical

Key Markets

Aerospace
Factory automation
Life science & medical
Machine tools
Packaging machinery
Paper machinery
Plastics machinery & converting
Primary metals
Semiconductor & electronics
Textile
Wire & cable

Key Products

AC/DC drives & systems
Electric actuators, gantry robots & slides
Electrohydraulic actuation systems
Electromechanical actuation systems
Human machine interface
Linear motors
Stepper motors, servo motors, drives & controls
Structural extrusions



Filtration

Key Markets

Aerospace
Food & beverage
Industrial plant & equipment
Life sciences
Marine
Mobile equipment
Oil & gas
Power generation & renewable energy
Process
Transportation
Water Purification

Key Products

Analytical gas generators
Compressed air filters & dryers
Engine air, coolant, fuel & oil filtration systems
Fluid condition monitoring systems
Hydraulic & lubrication filters
Hydrogen, nitrogen & zero air generators
Instrumentation filters
Membrane & fiber filters
Microfiltration
Sterile air filtration
Water desalination & purification filters & systems



Fluid & Gas Handling

Key Markets

Aerial lift
Agriculture
Bulk chemical handling
Construction machinery
Food & beverage
Fuel & gas delivery
Industrial machinery
Life sciences
Marine
Mining
Mobile
Oil & gas
Renewable energy
Transportation

Key Products

Check valves
Connectors for low pressure fluid conveyance
Deep sea umbilicals
Diagnostic equipment
Hose couplings
Industrial hose
Mooring systems & power cables
PTFE hose & tubing
Quick couplings
Rubber & thermoplastic hose
Tube fittings & adapters
Tubing & plastic fittings



Hydraulics

Key Markets

Aerial lift
Agriculture
Alternative energy
Construction machinery
Forestry
Industrial machinery
Machine tools
Marine
Material handling
Mining
Oil & gas
Power generation
Refuse vehicles
Renewable energy
Truck hydraulics
Turf equipment

Key Products

Accumulators
Cartridge valves
Electrohydraulic actuators
Human machine interfaces
Hybrid drives
Hydraulic cylinders
Hydraulic motors & pumps
Hydraulic systems
Hydraulic valves & controls
Hydrostatic steering
Integrated hydraulic circuits
Power take-offs
Power units
Rotary actuators
Sensors



Pneumatics

Key Markets

Aerospace
Conveyor & material handling
Factory automation
Life science & medical
Machine tools
Packaging machinery
Transportation & automotive

Key Products

Air preparation
Brass fittings & valves
Manifolds
Pneumatic accessories
Pneumatic actuators & grippers
Pneumatic valves & controls
Quick disconnects
Rotary actuators
Rubber & thermoplastic hose & couplings
Structural extrusions
Thermoplastic tubing & fittings
Vacuum generators, cups & sensors



Process Control

Key Markets

Alternative fuels
Biopharmaceuticals
Chemical & refining
Food & beverage
Marine & shipbuilding
Medical & dental
Microelectronics
Nuclear Power
Offshore oil exploration
Oil & gas
Pharmaceuticals
Power generation
Pulp & paper
Steel
Water/wastewater

Key Products

Analytical Instruments
Analytical sample conditioning products & systems
Chemical injection fittings & valves
Fluoropolymer chemical delivery fittings, valves & pumps
High purity gas delivery fittings, valves, regulators & digital flow controllers
Industrial mass flow meters/controllers
Permanent no-weld tube fittings
Precision industrial regulators & flow controllers
Process control double block & bleeds
Process control fittings, valves, regulators & manifold valves



Sealing & Shielding

Key Markets

Aerospace
Chemical processing
Consumer
Fluid power
General industrial
Information technology
Life sciences
Microelectronics
Military
Oil & gas
Power generation
Renewable energy
Telecommunications
Transportation

Key Products

Dynamic seals
Elastomeric o-rings
Electro-medical instrument design & assembly
EMI shielding
Extruded & precision-cut, fabricated elastomeric seals
High temperature metal seals
Homogeneous & inserted elastomeric shapes
Medical device fabrication & assembly
Metal & plastic retained composite seals
Shielded optical windows
Silicone tubing & extrusions
Thermal management
Vibration dampening



ENGINEERING YOUR SUCCESS.